

Window Shadings

Installation, Operation and Care
Instructions



Continuous Cord Loop
Operating System

CONTENTS

Getting Started:

Product View	1
Tools and Fasteners Needed	2

Installation:

Installation Overview	3
Mount the Installation Brackets — Inside Mount	4
Mount the Installation Brackets — Outside Mount	6
Mount the Installation Brackets — End Mount	8
Install the Shading	9
Attach the Universal Cord Tensioner (UCT)	9
Attach the Magnetic Hold-Down Brackets (Optional)	10
Attach the Dust Cover (Optional for Outside Mounts)	11

Operation:

Operate the Shading	12
Troubleshooting	13

Care:

Removing the Shading.....	15
Cleaning Procedures	15

Child Safety:

Warning	17
Cord Loop Shadings	17

Product View

Standard Shading

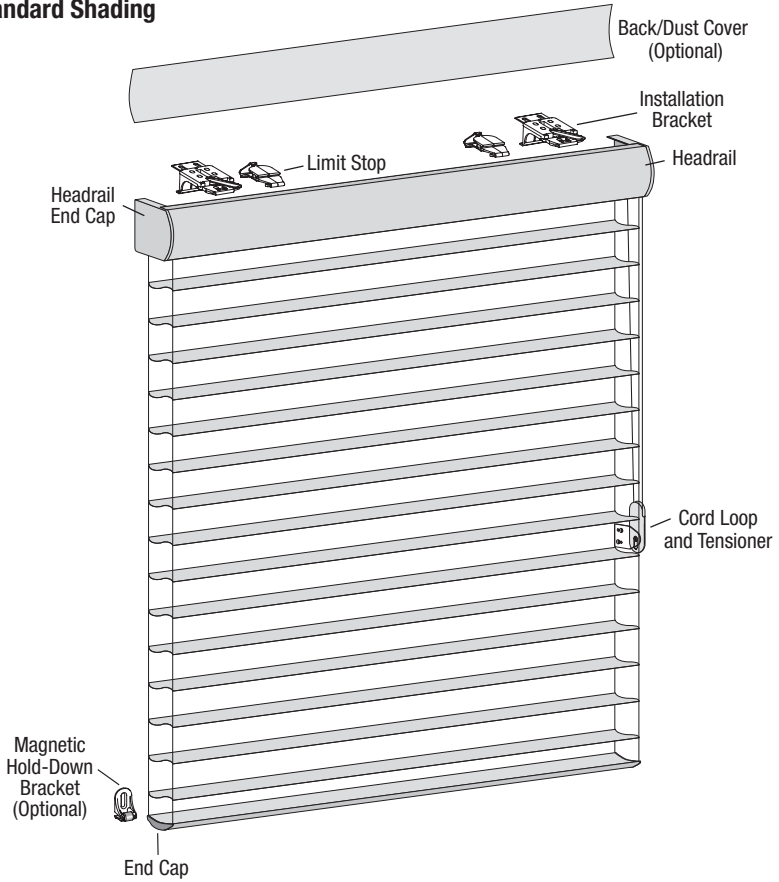

Two-On-One Headrail Shading

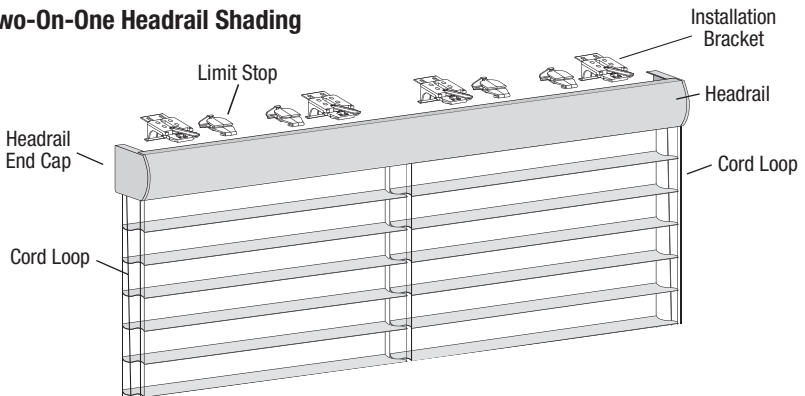

GETTING STARTED

Thank you for purchasing Window Shadings. With proper installation, operation, and care, your new shadings will provide years of beauty and performance. Please thoroughly review this instruction booklet before beginning the installation.

Tools and Fasteners Needed

- Flat blade and Phillips screwdrivers
- Level (laser level is recommended)
- Measuring tape and pencil
- Pliers
- Power drill, $\frac{3}{32}$ " drill bit, and $\frac{1}{4}$ " hex driver
- Scissors (heavy duty)

In addition, you will need fasteners designed to work with your specific mounting surface(s).

- **#6 Hex Head Screws (Provided).** Two $1\frac{1}{2}$ " screws are provided per installation bracket.
- **Longer #6 Hex Head Screws (Not Provided).** If using spacer blocks, use #6 screws long enough for a secure attachment.
- **Speed Nuts and Screws (Provided).** Extension brackets come with screws and speed nuts.
- **Drywall Anchors (Not Provided).** Use drywall anchors when mounting into drywall.



#6 x 1 1/2"
Hex Head Screw
(Provided)



Longer #6 Hex Head Screw
for Use with Spacer Blocks
(Not Provided)



Speed Nut
and Screw
(Two Provided with
Each Extension Bracket)

Installation Overview

- Your order will include the correct number of installation brackets for your shading width, as shown in the table below.
- Shading orders may also include spacer blocks or extension brackets, if they were specified for added clearance.
 - Extension brackets are used for end mount shadings, as well.

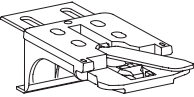
Installation Bracket	Panel Width	Brackets
	12" – 36"	2
	36 ¹ / ₈ " – 79"	3
	79 ¹ / ₈ " – 96"	4
	96 ¹ / ₈ " – 120"	5

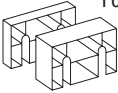

1/4" and 1/2"
Spacer Blocks

For Added Clearance

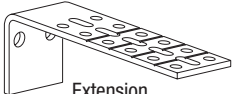

Extension
Bracket

- **Two-On-One Headrail Shadings.** Two additional installation brackets are provided.

Mounting Types and Window Terminology

If the installation brackets are mounted correctly, the rest of the installation process follows easily. To prepare for this important first step, review the mounting types and basic window terminology illustrated below.

Molding

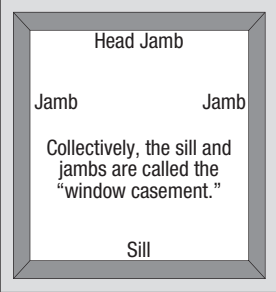

Head Jamb

Jamb Jamb

Collectively, the sill and
jamb are called the
"window casement."

Sill

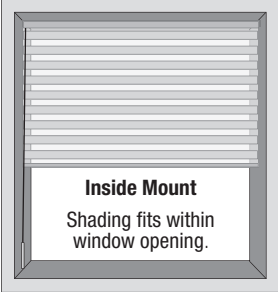

Inside Mount
Shading fits within
window opening.

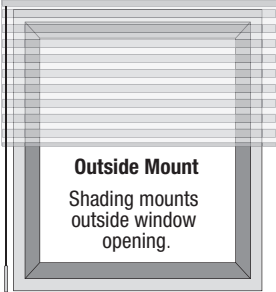

Outside Mount
Shading mounts
outside window
opening.

- Refer to the appropriate page below based on your order:
 - **Inside Mount — Page 4**
 - **Outside Mount — Page 6**
 - **End Mount — Page 8**

INSTALLATION

Mount the Installation Brackets — Inside Mount

Prepare the Installation Brackets

- **If using the optional back cover:** Use pliers or heavy duty scissors to remove both the top and bottom tabs on the installation brackets.
 - Then remove the top tab on the back cover brackets.
 - Snap the prongs on the back cover brackets into the holes on the back of the installation brackets.
- **If not using the optional back cover:** Remove the top tab only on the installation brackets.

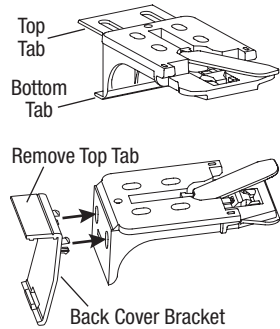

NOTE: Save these tabs once removed. They may be used as shims, as described later in these instructions.

Mount the Installation Brackets

- Mark 2" to 3" from each jamb for bracket location.
 - If more than two installation brackets came with your order, space additional bracket(s) evenly between the two end brackets and mark their location. Mount into wood whenever possible.

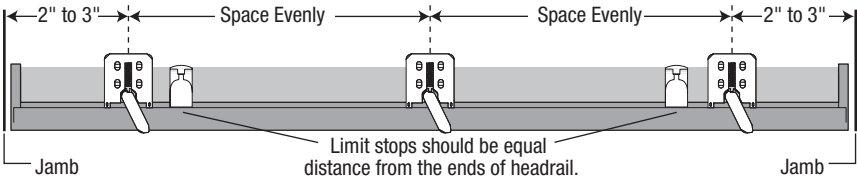

- **Two-On-One Headrail Shadings.** Two additional installation brackets should be placed on each side of the panel split.

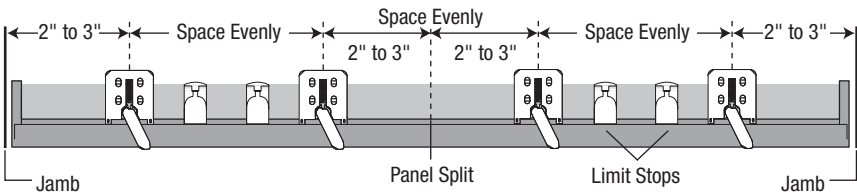

- Center the brackets on your marks, then mark the screw hole locations.

- The minimum casement depth for installation brackets is 1". Mark the rear set of installation bracket holes with shallow mounting depths.
- The minimum casement depth for a fully recessed mount is 3⁵/₁₆". Mark the front set of bracket holes when depth permits.
- Add 1/4" to the minimum depths if using the optional back cover.
- Use the rear set of holes with shallow mounting depths. Use the front set of holes when depth permits.

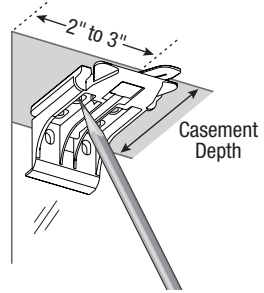

IMPORTANT: The front edges of the brackets must be level and aligned to each other.

- Drill the screw holes using a 3/32" drill bit.

CAUTION: Use drywall anchors when mounting into drywall.

- Use a level to check that the mounting surface is level. Shim the brackets, if necessary. (Use the top tab that was removed from the brackets.)
- Attach the installation brackets using the screws provided.

IMPORTANT: Do not overtighten the screws. Check to ensure the lever can be moved easily side to side. If not, loosen the screws in one-eighth turn increments until the lever can be moved easily.

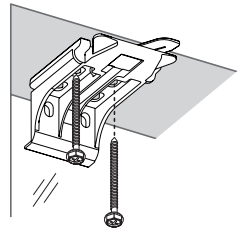

IMPORTANT: The front edges of the installation brackets must be level and aligned to each other.

- **If using the optional back cover:** Install the cover into the back cover brackets. If necessary, trim the back cover to the desired width.

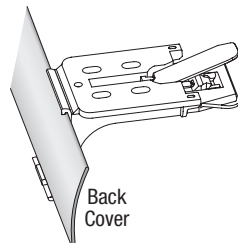

Proceed to "Install the Shading" on page 9.

INSTALLATION

Mount the Installation Brackets — Outside Mount

Prepare the Installation Brackets

- Use pliers or heavy duty scissors to remove both the top and bottom tabs on the installation brackets.

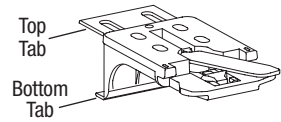

NOTE: Save these tabs once removed. They may be used as shims, as described later in these instructions.

Mount the Installation Brackets

- Center the headrail over the window opening at the desired height. Use a pencil to lightly mark each end of the headrail.
 - Alternatively, measure the width of the headrail and use that width to mark the headrail end points over the window opening.
- Mark 2" to 3" from each end of the headrail.
 - If more than two installation brackets came with your order, space additional bracket(s) evenly between the two end brackets and mark their location. Mount into wood whenever possible.

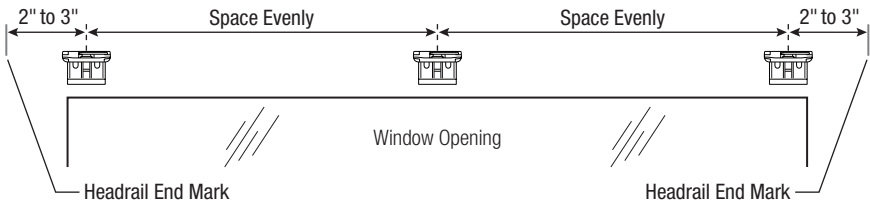

- **Two-On-One Headrail Shadings.** Two additional installation brackets should be placed on each side of the panel split.

- Center the installation brackets or extension brackets on your marks and mark where to drill the screw holes.
- A minimum $1\frac{1}{8}$ " flat vertical surface is required for the installation brackets. Extension brackets require $1\frac{1}{4}$ ".
- The tops of the installation brackets or extension brackets should be at the desired height. The brackets should be level and aligned.

CAUTION: The rear of the brackets must be flush against a flat mounting surface. Do not mount brackets on curved molding.

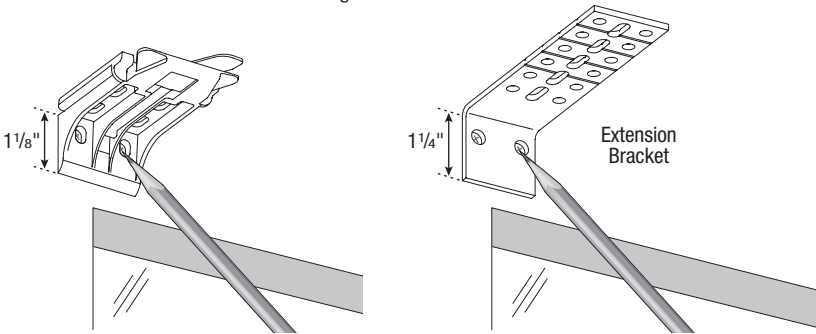

- Drill the screw holes using a $\frac{3}{32}$ " drill bit.

CAUTION: Use drywall anchors when mounting into drywall.

- Attach the installation or extension brackets using the screws provided.

IMPORTANT: The tops of the installation brackets or extension brackets must be level with their front edges aligned.

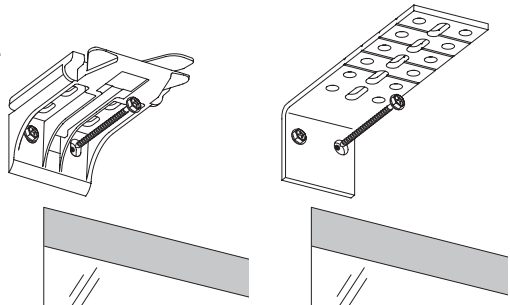

- If using spacer blocks, attach the spacer block(s) and installation bracket to a flat vertical mounting surface with #6 screws long enough for a secure installation.

IMPORTANT: Do not add more than $1\frac{1}{2}$ " of clearance using spacer blocks.

IMPORTANT: The tops of the installation brackets must be level with the front edges aligned.

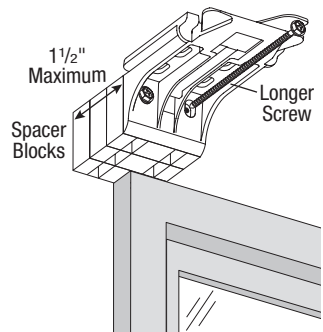

INSTALLATION

- If using extension brackets, attach an installation bracket to the underside of each extension bracket using the speed nuts and screws provided.

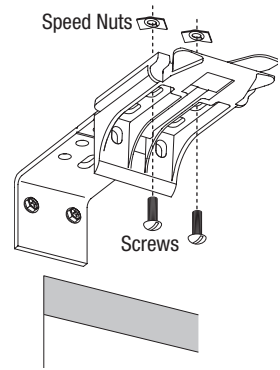

Proceed to “Install the Shading” on page 9.

Mount the Installation Brackets — End Mount

End mount the headrail when conventional mounting techniques will not work — for example, in an arched window opening.

- Mount the extension brackets on a surface at least 1 1/4" wide.
 - Add 1/4" to the minimum depth if using the optional back cover.
- Attach the installation brackets to the extension brackets using the provided screws and speed nuts.

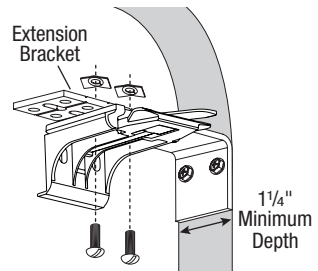

WARNING: To end mount shadings into a surface other than a secure wall stud, use medium to heavy-duty wall anchors (not provided) matched to the wall thickness. Failure to mount the brackets securely may result in injury or property damage.

- **If using the optional back cover:** Install the cover into the back cover brackets. If necessary, trim the back cover to the desired width.

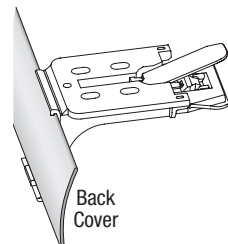

Proceed to “Install the Shading” on page 9.

Install the Shading

- Position the shading so that the front faces you.
- Slide the headrail into the installation brackets so the edge of the headrail is between the lever and the bracket, as shown.
- Firmly push the headrail into each bracket until it clicks and the lever snaps to the right side of the bracket.

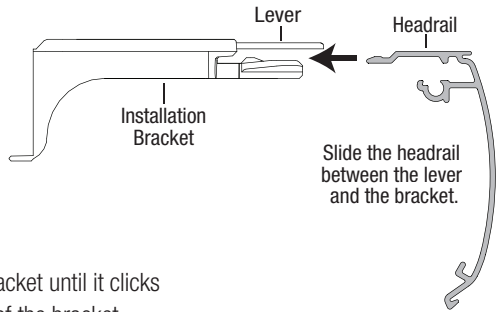

IMPORTANT: Carefully pull on the headrail at each bracket to ensure it is installed securely.

Attach the Universal Cord Tensioner (UCT)

Before you proceed, you must first slide the cord tensioner to the bottom of the cord loop.

- Insert a small screwdriver, punch, or awl through the screw hole at the bottom of the cord tensioner.
- Move the screw hole down to the indicator line to release the safety mechanism.
- Slide the cord tensioner down to the bottom of the cord loop.
- Attach the cord tensioner(s) according to the instructions provided with the *Universal Cord Tensioner Installation Kit*.

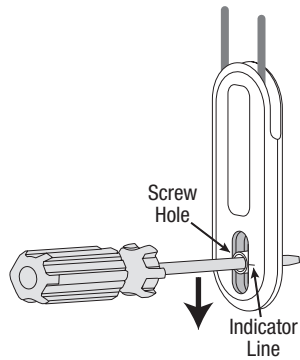

WARNING: It is imperative that the cord tensioner be properly secured to the wall or window frame to reduce children's access to the cord loop. Young children can strangle in cord loops. They can also wrap cords around their necks and strangle.

CAUTION: The shading will not operate properly unless the cord tensioner is secured. A *Universal Cord Tensioner Installation Kit* has been included with your shading. Follow the instructions in the kit to correctly secure the cord tensioner.

INSTALLATION

Attach the Magnetic Hold-Down Brackets (Optional)

- Lower the shading keeping the vanes closed.
- Place the magnetic hold-down bracket onto the bottom rail just inside the end cap, oriented as shown.
- Hold the bracket while opening and closing the vanes (it may be necessary to have someone else assist you). Adjust the bracket to the best overall position.
- Mark the screw location using the mounting options shown below.
 - The screw should be placed in the middle of the channel. This will allow for adjustment.

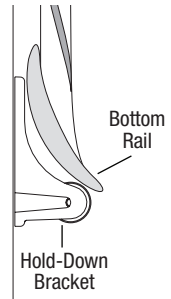

Outside Mount

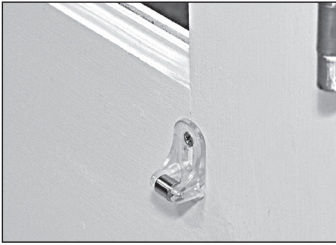

Preferred



Alternate

Inside Mount



Preferred



Alternate

- Drill the screw holes using a $\frac{3}{32}$ " drill bit.

IMPORTANT: Use drywall anchors when mounting into drywall.

- Attach the hold-down brackets to the mounting surface using the screws provided.
- If necessary, adjust bracket height by loosening the screw and sliding the bracket up or down.

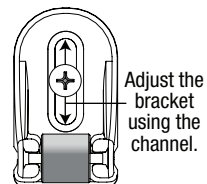

Attach the Dust Cover (Optional for Outside Mounts)

The dust cover is used to protect the top of the headrail from exposure to dust on outside mounted shadings.

- Cut the dust cover to desired width.
- Remove the paper backing on one side of the hook and loop fastener dots.
- Apply the dots to the installation brackets on each end of the shading.

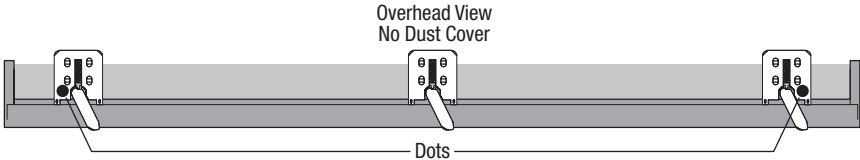
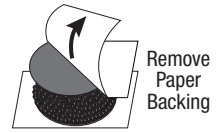

- Remove the remaining paper backing from the dots.
- Center the dust cover over the top of the shading, above the previously placed dots.
- Press the dust cover down onto the dots.



OPERATION

Operate the Shading

To Lower the Shading and Open the Vanes

- Pull the rear cord of the cord loop to lower the shading.
- With the shading fully lowered, continue to pull the rear cord to tilt the bottom rail and open the vanes.
- If the cord tensioner moves up the cord, you have not secured it to the wall or window frame. You must do so for the shading to operate properly.

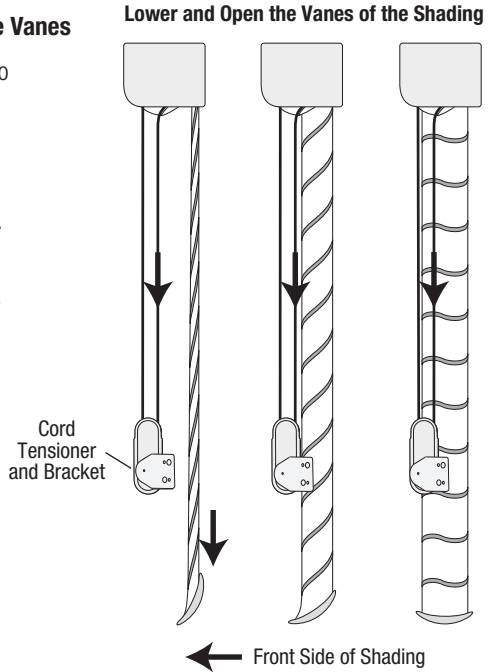

To Close the Vanes and Raise the Shading

- Pull the front cord of the cord loop to close the vanes and raise the shading.
- If the cord tensioner moves up the cord, you have not secured it to the wall or window frame. You must do so for the shading to operate properly.

IMPORTANT: If the shading raises or lowers unevenly, the fabric rubs against one end of the headrail, or the bottom rail is uneven when fully raised, the bottom rail weight needs to be adjusted. See “Adjusting the Bottom Rail Weight” on page 14.

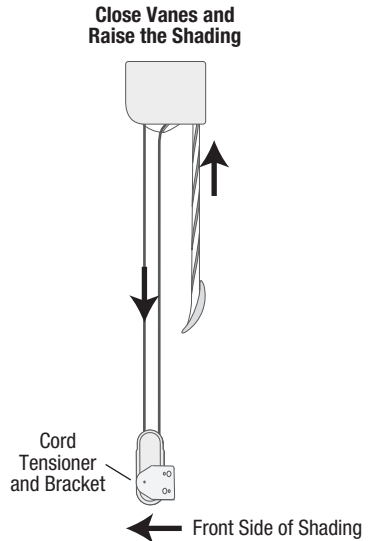

Troubleshooting

Problem	The shading will not snap into the installation brackets.
Solution	Check that the installation brackets are aligned and level. Check that the locking tab on the installation bracket slides over the headrail.
Problem	The shading is hard to raise or lower, or will not raise or lower.
Solution	Shadings cannot be forced into tight inside mount window openings. If an inside mount, check that the shading is installed correctly. Make sure there is clearance between the ends of the shading and the window casement. Check that the universal cord tensioner is mounted correctly. See “Attach the Universal Cord Tensioner (UCT)” on page 9. Check that the installation brackets are level. Shim to level, if necessary. Make sure the fabric is not caught.
Problem	Vanes do not align on side-by-side shadings.
Solution	Vane alignment is only guaranteed within 1/4" when shadings are ordered at the same time, at the same height, with the same color and fabric, and when specified on the order form. Check that the windows are square and the same height.
Problem	Two-On-One Headrail Shadings Only: The center gap is not even from the top to the bottom of the shading, interfering with the function of the shading.
Solution	Ensure the entire length of the headrail is straight and level. If the center portion of the headrail is higher than the ends, the center gap will close together. If the center portion of the headrail is lower than the ends, the center gap increases. If necessary, adjust the height of each bracket by moving it within the screw slots or by using shims.

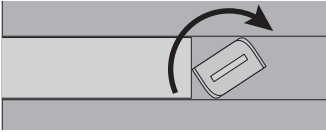
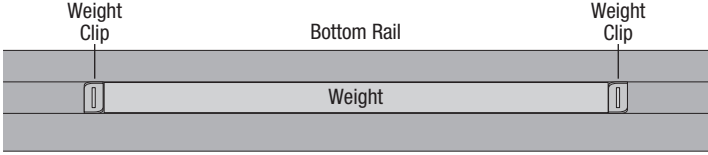
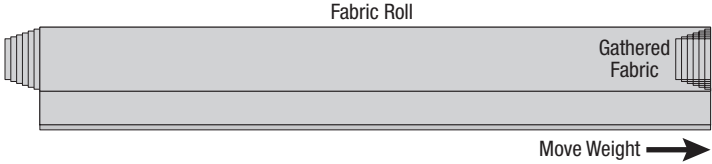
<p>Problem</p>	<p>The shading raises or lowers unevenly, the fabric rubs against one end of the headrail, or the bottom rail is uneven when fully raised.</p>
<p>Solution</p>	<p>Check that the window is square by measuring the diagonals.</p> <p>Check that the installation brackets are level. Shim to level, if necessary.</p> <p>Adjust the bottom rail weight. See below.</p> <p>Adjusting the Bottom Rail Weight</p> <ul style="list-style-type: none"> ■ Release the weight clips by inserting a flat blade screwdriver into the weight clip and turning clockwise.   <ul style="list-style-type: none"> ■ Move the weight in 1" increments toward the side where the fabric is gathering.  <ul style="list-style-type: none"> ■ Secure the weight clips in position by turning them counterclockwise after making the adjustment. ■ Test and, if necessary, adjust again.
<p>Problem</p>	<p>The universal cord tensioner has climbed to the headrail.</p>
<p>Solution</p>	<p>Pull down on the spring to relieve tension and pull the universal cord tensioner to the bottom of the cord loop. Properly mount the cord tensioner. See the <i>Universal Cord Tensioner Installation Instructions</i> included with your shading.</p>
<p>Problem</p>	<p>The universal cord tensioner grabs onto the cord upon operation.</p>
<p>Solution</p>	<p>Check that the universal cord tensioner is mounted properly. Reinstall, if necessary.</p>

Removing the Shading

- Fully raise the shading.
- Move the lever on the installation brackets to the left to release the shading.
 - A flat blade screwdriver can be used to move the lever.
 - If the lever is inaccessible or inoperable, lower the shading until you can see the underside of the bracket. Carefully reach a small flat blade screwdriver behind the shading to the tab on bottom of the bracket between the screw holes.
 - Push the tab away from the shading and pull the headrail to release it from the bracket.

CAUTION: Be very careful not to tear or damage any of the fabric.

- Carefully pull the shading to remove it from the brackets.

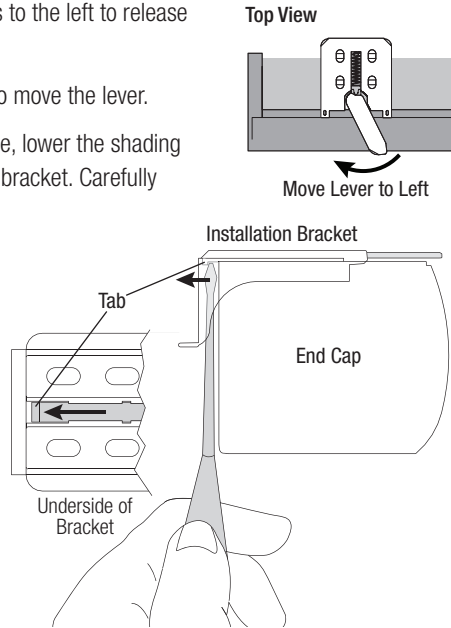

Cleaning Procedures

Window Shadings are made of 100% polyester, which means they are inherently durable and resilient. However, care must be taken to avoid wrinkling the fabric, particularly where the vanes meet the facings.

Dusting

- Regular light dusting with a feather duster is all the cleaning that is needed in most circumstances.

Vacuuming

- Use a low suction, hand-held vacuum for more thorough dust removal.

Forced Air

- Blow away dirt and debris between the vanes using clean compressed air.

Spot-Cleaning

- Do not spot-clean window shadings.

Ultrasonic Cleaning

Window Shadings can be ultrasonically cleaned by a professional with the exception of light dimming fabrics.

- Specify that a mild detergent solution be used.
- Never immerse the headrail in the solution.
- Dry the shading completely in the lowered position.

Injection/Extraction

Window Shadings can be professionally cleaned using the injection/extraction method.

- A dry method of injection/extraction is required for light dimming fabrics.
- Never immerse the headrail in the solution.

Electrostatic Cleaning

Do not use electrostatic cleaning wipes on any Window Shadings.

A Note About Fabrics

As with all textiles, Window Shading fabrics are subject to some variations. Slight wrinkling, puckering, or bowing is inherent to this textile product and should be considered normal, acceptable quality. These characteristics are not usually visible from the front or rear but may be visible from a side angle.

Precautions should be taken to reduce exposure to harsh environmental elements, such as salt air. Continuous exposure through open windows and doors will accelerate the fabric deterioration.



Young children can **STRANGLE** in cord loops. They can also wrap cords around their necks and **STRANGLE**.

- Always keep cords out of the reach of children.
- Move cribs, playpens and other furniture away from cords. Children can climb furniture to get to cords.

Cord Loop Shadings

- Attach the cord tensioner on the cord loop to the wall or window casement. See “Attach the Universal Cord Tensioner (UCT)” on page 9. This can prevent children from pulling cord loops around their necks.
- A cord tensioner installation kit is provided with each cord loop shading, which includes instructions for attaching the cord tensioner. For the shading to operate properly, the cord tensioner must be correctly mounted and secured.
- Fasteners provided in this kit may not be appropriate for all mounting surfaces. Use appropriate anchors for mounting surface conditions.
- Only supplied cord tensioners and hardware should be used. Replacement parts may be obtained by contacting your window coverings dealer.

