

AUTOMATE™

Paradigm Cut-In Wall Switches



433 MHz

AUTOMATE™ | Paradigm wall switches feature a contemporary design and a wirefree deployment, making them retrofit ready for any location. Available in single, double or 15 channel configurations, Paradigm switches are perfect for individual room and whole home shade control.

FEATURES:

- Available in single, double & Fifteen Channel.
- LCD display (15 Channel SWITCH).
- Compatible with screwless decorator cover plates.
- Hide unused channel function (15 Channel SWITCH).
- Retrofit Ready.
- Group Control.
- Lock Feature prevents unwanted limit changes when active.

CONTENTS

| | | |
|----------|--|-----------|
| 1 | TECHNICAL DATA / PACK CONTENTS | 3 |
| 2 | SAFETY | 4 |
| 3 | INSTALLATION | 5 |
| 3.1 | Install switch batteries | 5 |
| 3.2 | Mount switch | 5 |
| 4 | FUNCTIONAL OVERVIEW | 6 |
| 4.1 | Buttons | 6 |
| 4.2 | Selecting a channel (15 channel switch) | 6 |
| 4.3 | Group control using CH "0" | 7 |
| 4.4 | Hide unused channels (15 channel switch) | 7 |
| 4.5 | Lock Limit Setting (1 & 2 channel switch) | 8 |
| 4.6 | Lock Limit Setting (15 channel switch) | 8 |
| 5 | ADDING / REMOVING CONTROLLERS & CREATING GROUP CHANNELS | 9 |
| 5.1 | Using motor P1 button | 9 |
| 5.2 | Using a pre-existing controller | 9 |
| 6 | TROUBLESHOOTING | 10 |

1 TECHNICAL DATA / PACK CONTENTS

| TECHNICAL SPECIFICATIONS | |
|--------------------------------|-------------------------------|
| Voltage: | 3V (2 x AAA) |
| Frequency: | 433.92 MHz |
| Transmitting Power: | 10 milliwatt |
| Ambient Operating Temperature: | -10°C -50°C |
| Transmission Distance: | up to 200 meters (open space) |

PACK CONTENTS

- 1 x switch (Single, Double or Fifteen Channel)
- 2 x Wall fixing screws & anchors
- 1 x Instruction manual
- 2 x 1.5V - AAA batteries
- 1 x white single gang decorator style wall plate (incl. 2 mounting screws)

2 SAFETY

WARNING: Important safety instructions to be read before installation and use.

Incorrect installation or use can lead to serious injury and will void manufacturer's liability and warranty.

It is important for the safety of persons to follow the enclosed instructions. Save these instructions for future reference.

- Do not expose to water, moisture, humid and damp environments or extreme temperatures.
- Persons (including children) with reduced physical, sensory or mental capabilities, or lack of experience and knowledge should not be allowed to use this product.
- Use or modification outside the scope of this instruction manual will void warranty.
- Installation and programming to be performed by a suitably qualified installer.
- Follow installation instructions.
- For use with motorized shading devices.
- Keep away from children.
- Frequently inspect for improper operation. Do not use if repair or adjustment is necessary.
- Keep clear when in operation.
- Replace battery with correctly specified type.

Rollease Acmeda declares this equipment is in compliance with the essential requirements and other relevant provisions of R&TT EC Directive 1999/5/EC

Statement Regarding FCC Compliance

This device complies with Part 15 of the FCC Rules. Operation is subject to the following two conditions:

- (1) This device may not cause harmful interference, and
- (2) This device must accept any interference received, including interference that may cause undesired operation.

Note:

This equipment has been tested and found to comply with the limits for a Class B digital device, pursuant to Part 15 of the FCC Rules. These limits are designed to provide reasonable protection against harmful interference in a residential installation. This equipment generates, uses and can radiate radio frequency energy and, if not installed and used in accordance with the instructions, may cause harmful interference to radio communications.

However, there is no guarantee that interference will not occur in a particular installation. If this equipment does cause harmful interference to radio or television reception, which can be determined by turning the equipment off and on, the user is encouraged to try to correct the interference by one or more of the following measures:

- Reorient or relocate the receiving antenna.
- Increase the separation between the equipment and receiver.
- Connect the equipment into an outlet on a circuit different from that to which the receiver is connected.
- Consult the dealer or an experienced radio/TV technician for help.

Any changes or modifications not expressly approved by the party responsible for compliance could void the user's authority to operate the equipment.



Do not dispose of in general waste.
Please recycle batteries and damaged electrical products appropriately.



3 INSTALLATION

3.1 Install switch batteries

Open rear battery cover by pressing gently in, then sliding down.

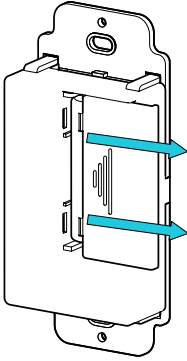

Install 2 x AAA batteries with negative side facing springs.

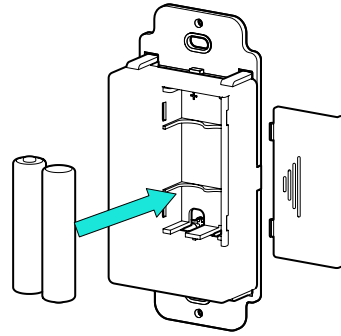

Replace cover by sliding into place.

3.2 Mount switch

Use supplied fasteners and anchors as needed to attach base.

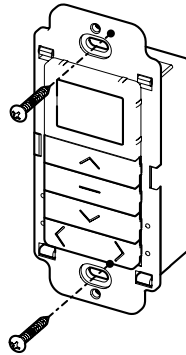

4 FUNCTIONAL OVERVIEW

4.1 Buttons

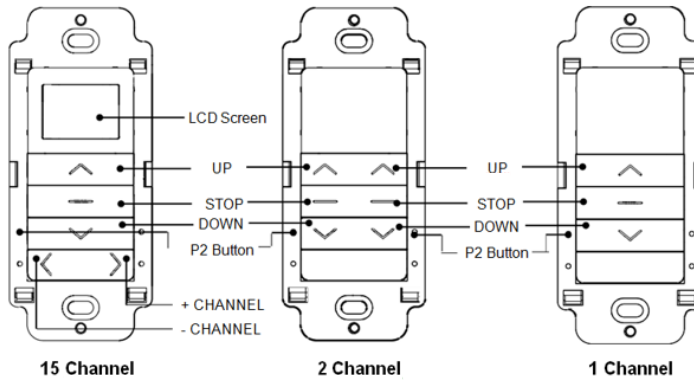

4.2 Selecting a channel (15 channel switch)

Use left and right arrows to change channels.

Press right arrow button to increase channel.



Response

.....
LCD screen will indicate selected channel.



.....
Please refer to the relevant documentation of your motor model for instructions on adjusting motor settings.

4.3 Group control using CH "0"

Channel "0" is pre-set to control ALL shades paired within your multi-channel switch. To create a customized group channel ref to section 5.2

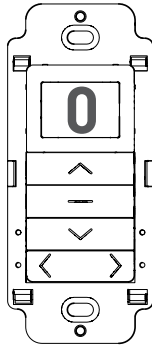

4.4 Hide unused channels (15 channel switch)

Your multi channel switch can be configured to have anywhere between 1 to 15 visible channels. Inactive channels will not be visible when scrolling through the < > selections.

Press and hold left and right arrow buttons for three seconds.

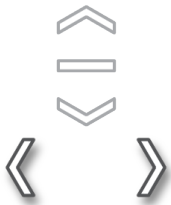

Response

LCD screen displays "C" then changes to "15"

Press right arrow button to decrease channels.



Response

LCD screen displays the selected number of channels.

Press the **STOP** button

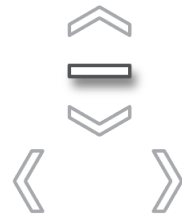

Response

LCD screen displays "o" to indicate the channel number has been set.

4.5 Lock Limit Setting (1 & 2 channel switch)

The upper and lower limit setting can be locked by holding the **STOP** button for 15 seconds. Holding the **STOP** button for a further 15 seconds will unlock these settings.

Press **STOP** and hold for 15 seconds.



Release **STOP** button.
Locked limit settings.

Press **STOP** and hold for 15 seconds.



Release **STOP** button.
Unlocked limit settings.

Remote response



All lights flash x1

Remote response



All lights flash x2

4.6 Lock Limit Setting (15 channel switch)

The 15 channel remote uses the LCD screen to notify the user when the lock feature has been activated.

Press **STOP** and hold for 15 seconds.



Release **STOP** button.
Unlocked limit settings.

Press **STOP** and hold for 15 seconds.



Release **STOP** button.
Locked limit settings.

Remote response



LCD flash "U" x2

Remote response



LCD flash "L" x2

5 ADDING / REMOVING CONTROLLERS & CREATING GROUP CHANNELS



IMPORTANT

Multiple motors can be grouped onto shared channels for co-ordinated control. Limit settings and favorite positions cannot be adjusted when motors are grouped together.

- * Confirm that motor limits and favorite position are already set for each individual motor.
- * Ensure that each motor you want to group is also assigned to another channel by itself

5.1 Using motor P1 button

Select channel on Switch.
Using the side arrow buttons.

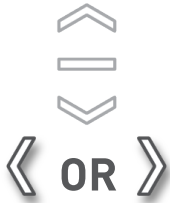

Hold **P1** button on motor head.

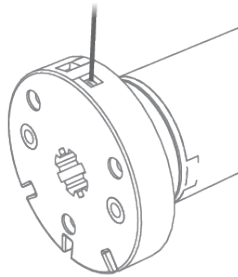

Hold **STOP** on Switch.

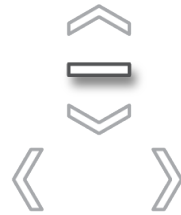

Motor Response



JOG X1



EXT. BEEP X1

RELEASE P1

Motor Response



JOG X2

BEEP X3

5.2 Using a pre-existing controller

A= Existing controller or channel (to keep) **B=** Controller or channel to add or remove

Press **P2** on existing switch.



Press **P2** on existing switch.



Press **P2** on new switch or remote controller.



Motor Response



Motor Response



Motor Response



6 TROUBLESHOOTING

| Problem | Cause | Remedy |
|---|---|--|
| Motor is not responding | Switch battery is discharged | Replace battery |
| | Battery is inserted incorrectly | Check battery polarity |
| | Radio interference / Shielding | Ensure switch is positioned away from metal objects and that antenna on motor or receiver is kept straight and away from metal. |
| | Receiver distance is too far from remote | Move switch to a closer position |
| | Power failure | Check power supply to motor is connected and active |
| | Incorrect wiring | Check wiring is connected correctly (refer to motor installation instructions) |
| Cannot set limits on a single motor (multiple motors respond) | Using "Group" channels to adjust motor limits | Always reserve an individual channel for programming functions. SYSTEM BEST PRACTICE - Provide an extra 15 channel switch in your multi motor projects, that provides individual control for each motor for programming purposes. |
| Unabel to set limits after pairing remote | Transmitter has been locked | Change transmitter condition to its unlocked state. |



NOTE

The switch can be used to set/adjust limits.

Please refer to the motor instructions for limit setting functions.

NOTES

ROLLEASE ACMEDA
AUSTRALIA

110 Northcorp Boulevard,
Broadmeadows VIC 3047

T +61 3 9355 0100 | F +61 3 9355 0110

Queensland Branch
Unit 2/62 Borthwick Avenue,
Murarrie QLD 4172

ROLLEASE ACMEDA
USA

200 Harvard Avenue
Stamford, CT 06902 6320

T +1 203 964 1573 | F +1 203 964 0513

ROLLEASE ACMEDA
EUROPE

Via Conca Del Naviglio 18, Milan
(Lombardia) Italy

T +39 02 8982 7317 | F +39 02 8982 7317

info@rolleaseacmeda.com
rolleaseacmeda.com