

| 1 | | 2 | | 3 | | 4 | | 5 | | 6 | |
|-------------------------|-----------|-----------------|---------------------|---|------------|--------|--|---|--|---|--|
| TECHNICAL SPECIFICATION | | METERIAL | | | | FINISH | | | | | |
| FREQUENCY RANGE | DC~18GHz | Inner conductor | Beryllium copper | | Gold | | | | | | |
| IMPEDANCE | ≥5000MΩ | Insulator | PEI | | — | | | | | | |
| OPERATING TEMP | -55℃~+70℃ | Body | Stainless steel 303 | | Passivated | | | | | | |
| VSWR | ≤1.25 | Nut | Stainless steel 303 | | Passivated | | | | | | |

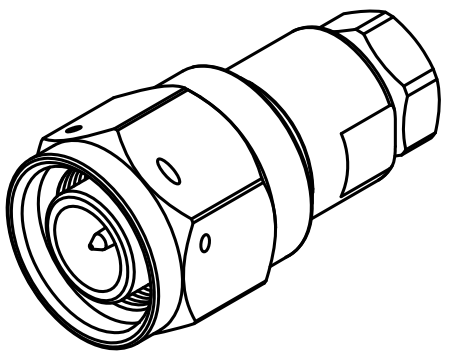

UNLESS OTHERWISE SPECIFIED
 1) ALL DIMENSIONS ARE AFTER PLATING.
 2) BREAK CORNERS & EDGES.005 R. MAX.
 3) CHAM. 1ST & LAST THREADS.
 4) SURFACE ROUGHNESS 63 √ MIL-STD-10.
 5) DIA S ON COMMON CENTERS TO BE CONCENTRIC WITHIN .004 T.I.R.
 6) REMOVE ALL BURRS

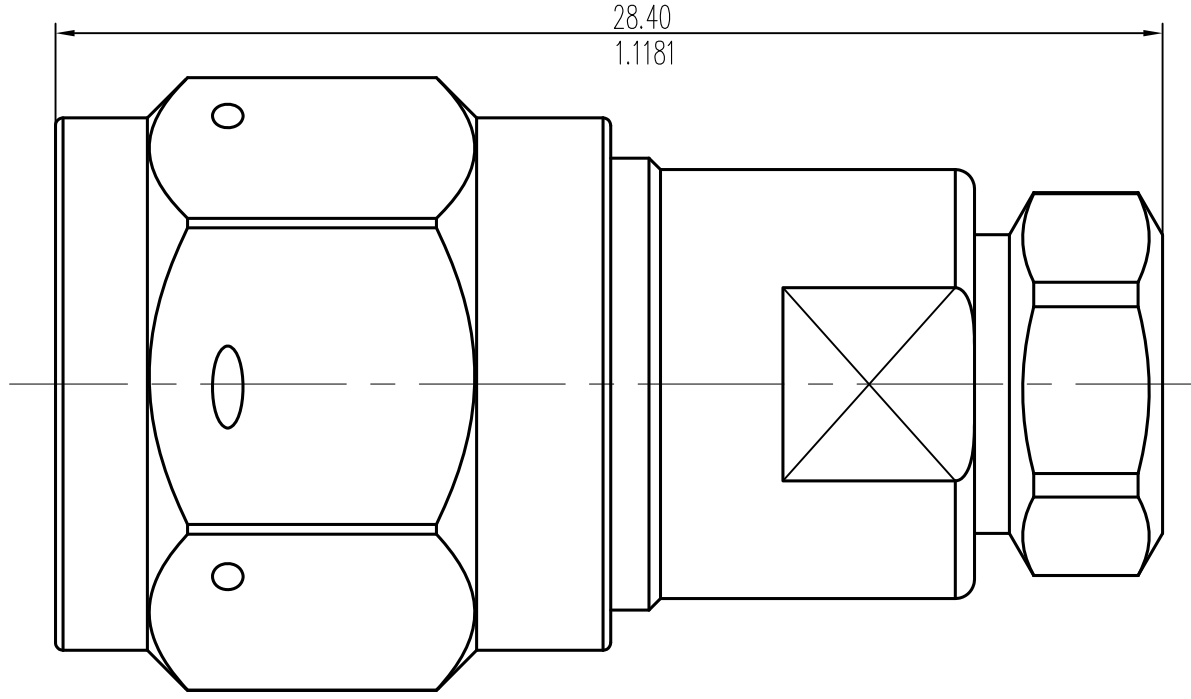

PROPRIETARY
 THE INFORMATION CONTAINED IN THIS DRAWING IS THE SOLE PROPERTY OF LANJIAN, INC. WITHOUT THE WRITTEN PERMISSION OF LANJIAN ELECTRONICS, INC IS PROHIBITED.

DRAWN:
 CHECKED:
 STANDARDIZATION:
 APPROVED:

DWG.NO. TNC-M3449
 TITLE: SIZE 5:1
 CAGE CODE: SHEET 1/1

A

A

B

B

C

C

D

1