

EQUIPMENT FOR
WOOD PROCESSING

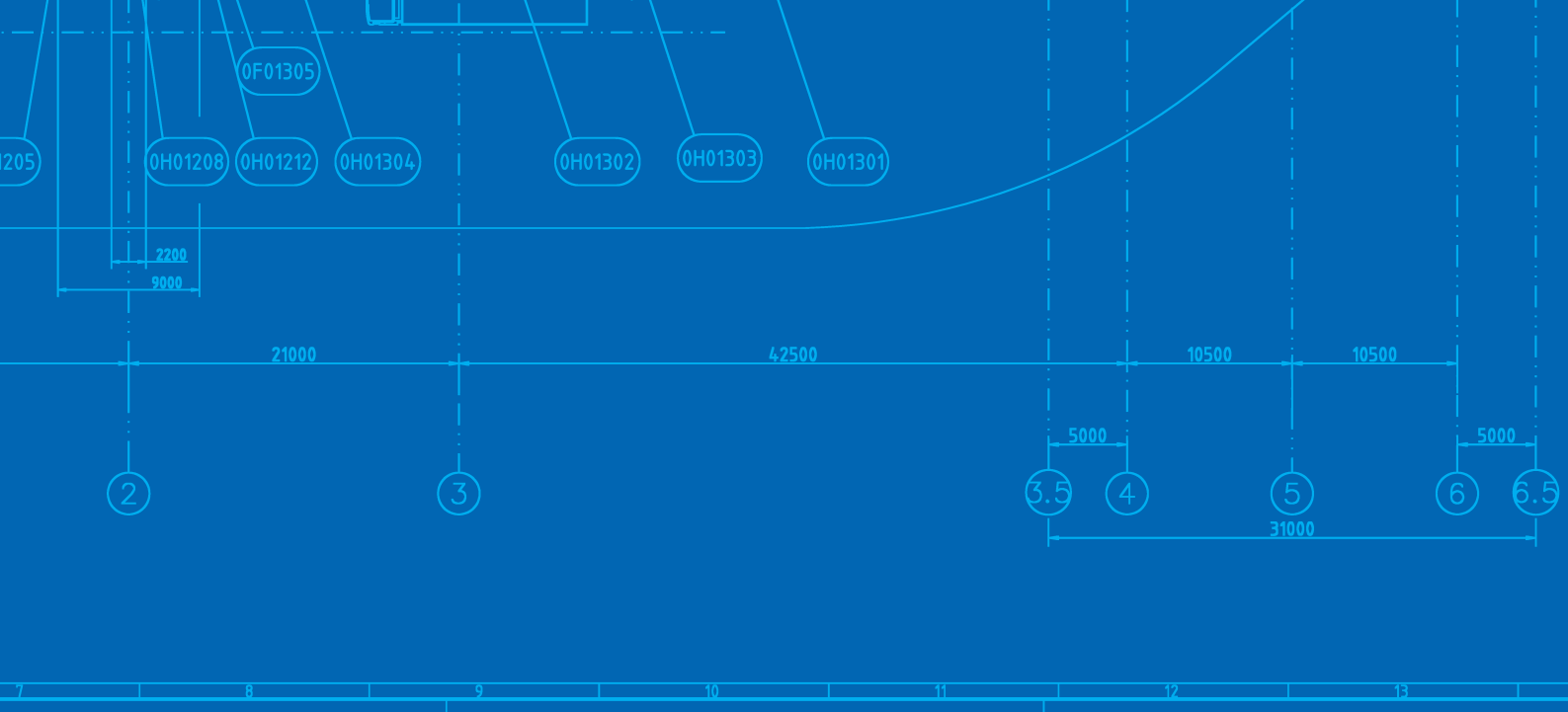

SAWMILL INDUSTRY

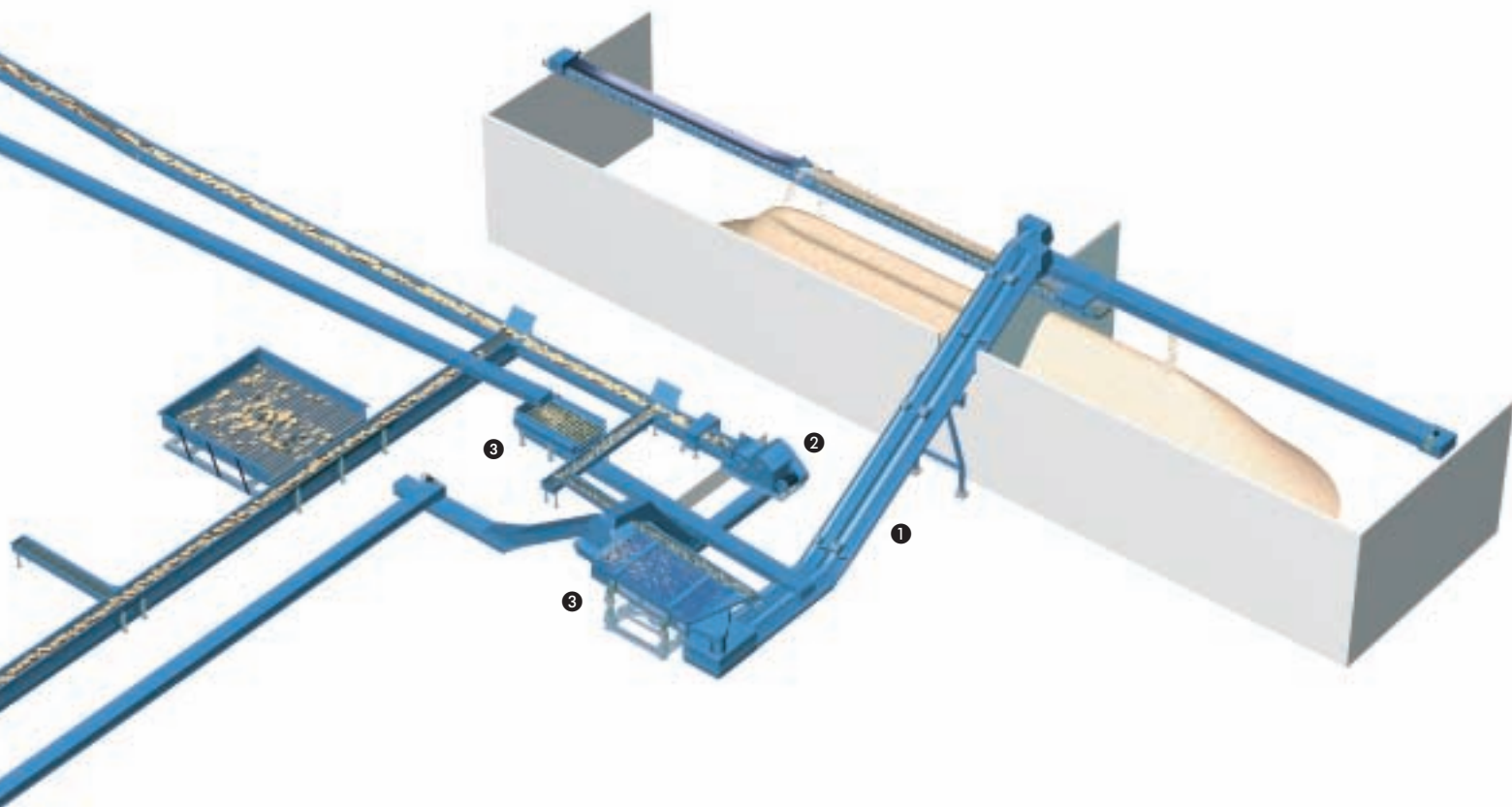

① Conveyors

- Tubulators
- Belt conveyors
- Chain conveyors
- Screw conveyors
- Vibratory conveyors

② Chippers

- Drum chippers
- Disc chippers

③ Screens

- Gyrotary screens
- Free-swinging screens
- Disc screens
- Drum screens
- Vibratory screens

● Butt flare reducers

- Crane/loader-fed reducers
- Automated reducers
- High-capacity reducers
- Double-cutter reducers

BRUKS is a leading supplier

of wood residue processing equipment for sawmills to optimize chip and fibre yield. Core products include drum chippers, screens and the dust- and spill-free Tubulator belt conveyors.



BIO-FUEL PREPARATION

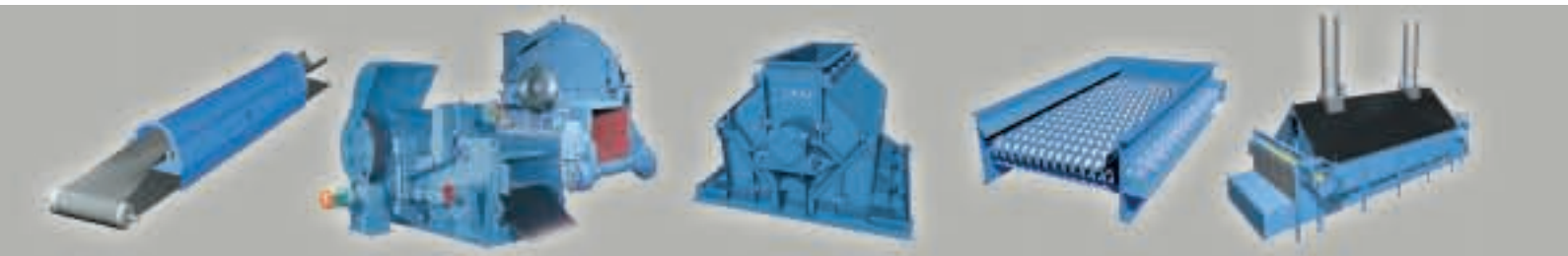
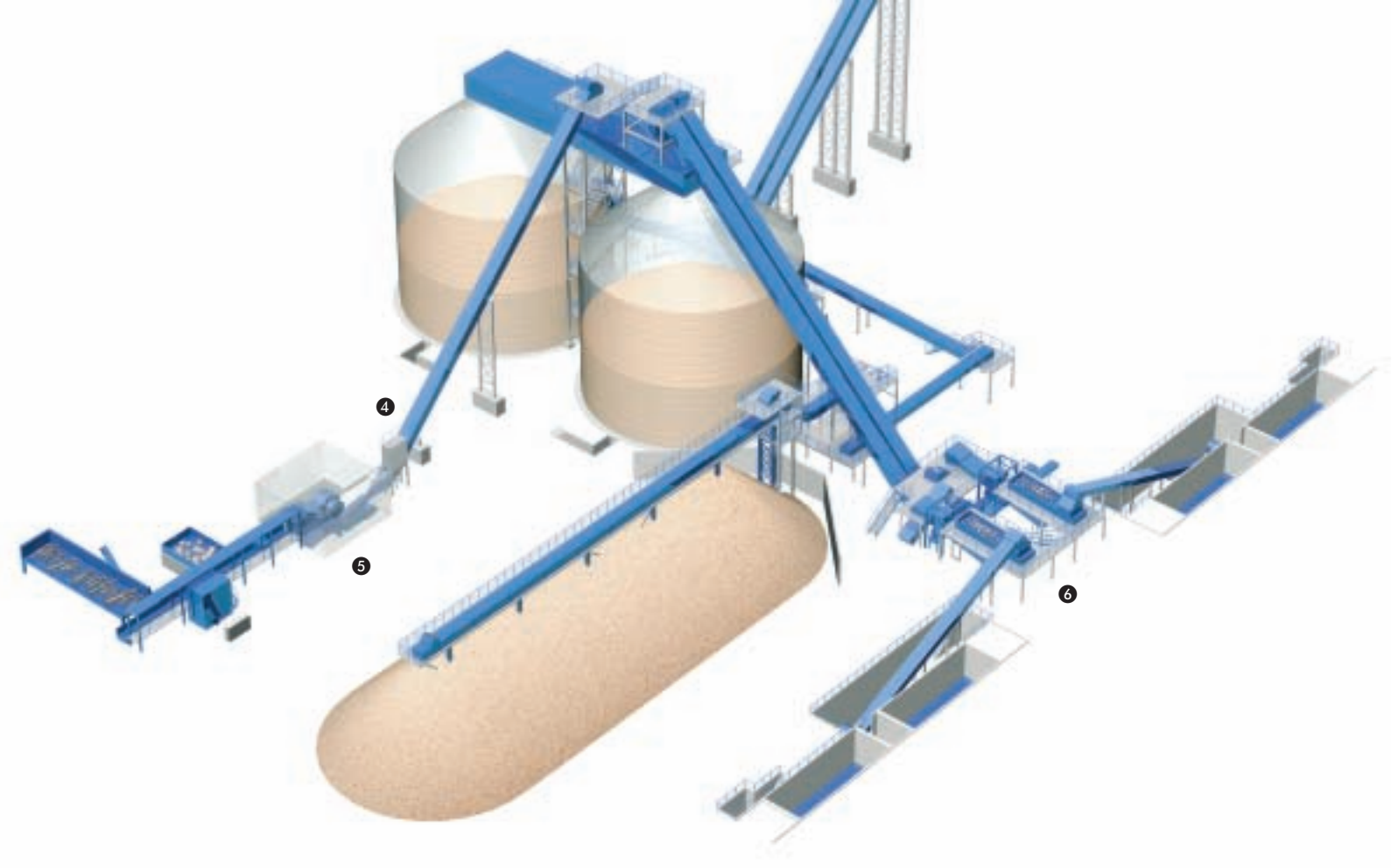

4 Conveyors

- Tubulators
- Belt conveyors
- Chain conveyors
- Screw conveyors
- Vibratory conveyors

5 Chippers

- Drum chippers
- Disc chippers
- Stationary installations
- Mobile installations

● Hogs/mills

- Rotom-Hog
- Hammer mills
- Board shredders

6 Screens

- Gyrotory screens
- Free-swinging screens
- Disc screens
- Drum screens
- Vibratory screens

● Bed dryers

- Single-stage low-temperature dryers

BRUKS delivers

complete bio-fuel processing and handling systems up to the boiler infeed – including hammer mills, hogs and chippers for size-reduction, low-temperature dryers as well as Tubulator conveyors for dust-free handling. Mobile chippers and other forest processing equipment are supplied through Bruks BioTech.



PULP & PAPER INDUSTRY



7 Conveyors

- Tubulators
- Belt conveyors
- Chain conveyors
- Screw conveyors
- Vibratory conveyors

8 Chippers

- Drum chippers
- Disc chippers

9 Hogs/mills

- Rotom-Hog
- Hammer mills

10 Screens

- Gyratory screens
- Free-swinging screens
- Disc screens
- Drum screens
- Vibratory screens

BRUKS supplies

disc and drum chippers and complete screening systems for the production of optimum chip quality; hogs for bark and waste wood processing; and the dust-free Tubulator belt conveyor for complete materials handling systems.



BOARD INDUSTRY

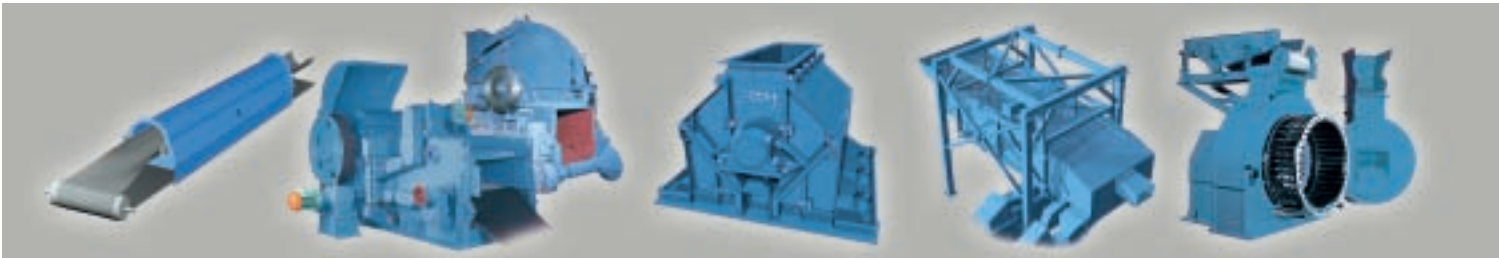
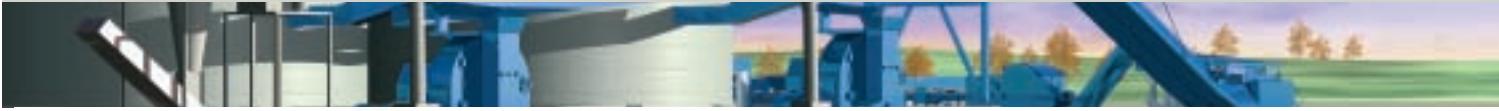

11 Conveyors

- Tubulators
- Belt conveyors
- Chain conveyors
- Screw conveyors
- Vibratory conveyors

12 Chippers

- Drum chippers
- Disc chippers

● Hogs/mills

- Rotom-Hog
- Hammer mills
- Board shredders

13 Screens

- Gyrotory screens
- Free-swinging screens
- Disc screens
- Drum screens
- Vibratory screens

14 Chip flakers

- Knife-ring flakers
- Beating flakers
- Refining mills

BRUKS focuses

on fibre preparation for the board industry by supplying waste wood drum chippers, modular chip flakers, hammer mills and complete materials handling systems.

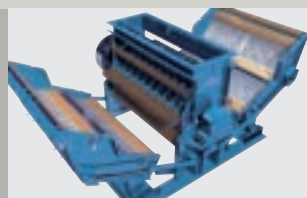

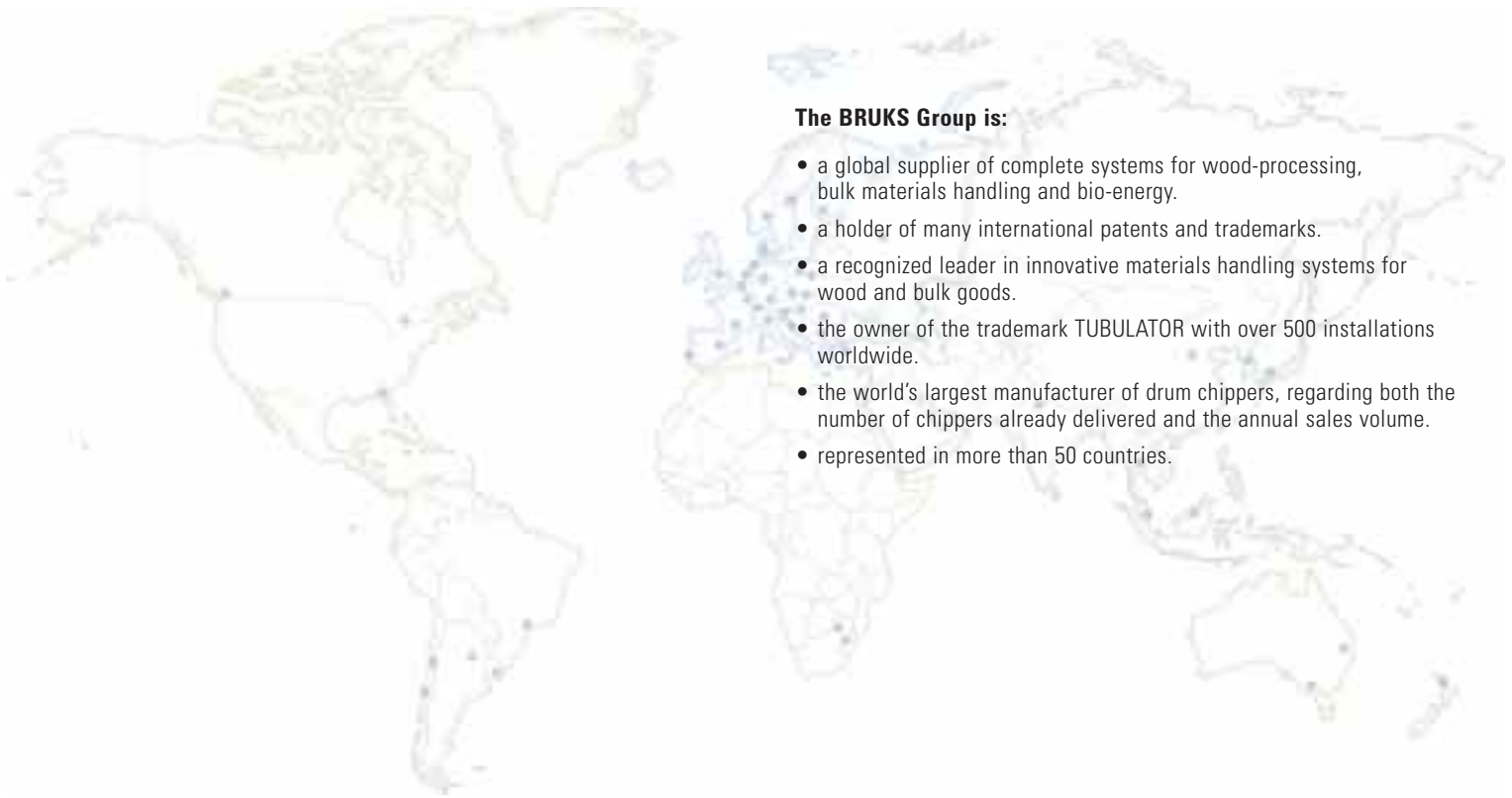

The BRUKS Group is:

- a global supplier of complete systems for wood-processing, bulk materials handling and bio-energy.
- a holder of many international patents and trademarks.
- a recognized leader in innovative materials handling systems for wood and bulk goods.
- the owner of the trademark TUBULATOR with over 500 installations worldwide.
- the world's largest manufacturer of drum chippers, regarding both the number of chippers already delivered and the annual sales volume.
- represented in more than 50 countries.

BRUKS – YOUR GLOBAL PARTNER

SWEDEN

BRUKS AB

Box 46 · Västergatan
820 10 Arbrå
Sweden
Phone: +46 (0)278-642500
Fax: +46 (0)278-642520
info@bruks.com

BRUKS Celltec AB

Nygatan 24
891 34 Örnsköldsvik
Sweden
Phone: +46 (0)660-294550
Fax: +46 (0)660-294570
info@bruks.com

BRUKS Gvc AB

Strandvägen 64
870 52 Nyland
Sweden
Phone: +46 (0)612-772480
Fax: +46 (0)612 225 83
info@bruks.com

BRUKS Rotom

Box 46 · Västergatan
820 10 Arbrå
Sweden
Phone: +46 (0)278-642500
Fax: +46 (0)278-642520
info@bruks.com

GERMANY

BRUKS Klöckner GmbH

Grabenstr. 1
57647 Hirtscheid
Germany
Phone: +49 (0)2661-280
Fax: +49 (0)2661-28180
info.de@bruks.com

USA

BRUKS Rockwood Inc.

5975 Shiloh Road, Suite 109
Alpharetta, GA 30005
USA
Phone: +1-770-849-0100
Fax: +1-770-495-7195
info.us@bruks.com

BRUKS Rockwood Inc.

P.O. Box 2466
Snohomish, WA 98291
USA
Phone: +1-360-863-2947
info.us@bruks.com

CHINA

BRUKS Beijing Representative Office

Zhu Zong Plaza, Room 1210
Chao Yang District
Huan Zhong Lu 25
100020 Beijing
China
Phone: +86-136-0114-8282
info@bruks.com