

SERVO DRIVE TURRET PUNCH PRESS
AFFORDABLE AMADA PERFORMANCE & QUALITY

AE NT Series

AE 255, 2510NT



Amada's Industry Leading AC Servo Drive Technology Maximizes Performance While Reducing Production and Operating Costs.

With more than 30,000 machines in operation, Amada has earned a worldwide reputation as a leader in turret punch press technology. The AE-NT Series was engineered as part of an ongoing commitment to provide manufacturers with the widest range of high-performance punching solutions.

The AE-NT Series is packed with a wide variety of standard features to ensure that parts are produced faster, easier and more economically.

- The AE-NT Series utilizes an AC servo motor to drive the ram (eliminating hydraulic power supply and hydraulic fluid chiller).
- Electrical consumption is less than one-half of comparable hydraulic machines.
- The AE-NT Series offers significantly faster punching speeds than mechanical turret punch presses while providing superior ram motion control.

- Space-saving design makes the most of valuable floor space.
- AE2510-NT model processes 4' x 8' sheets without repositioning to help maximize material utilization.
- AE255-NT model has 4' x 4' sheet capacity (Processes 4' x 8' sheets with reposition)



TURRET

Layout pattern	45 st. (4AI)	51st. (4AI)	58 st. (2AI)
Maximum tool size	E(4½")	D(3½")	E(4½")
Number of type A (1½") st.	24	24	36
Number of type B (1-1/4") st.	12	18	12
Number of type C (2") st.	2	3	4
Number of type D (3-1/2") st.	1	2	2
Number of type E (4-1/2") st.	2	–	2
Number of type G (1-1/4") st.	2	3	2
Number of type H (2") Auto-index st.	2	1	–

45 stations (4 auto-index stations) 51 stations (4 auto-index stations) 58 stations (2 auto-index stations)

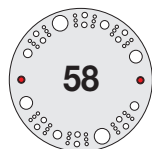
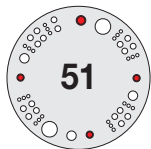
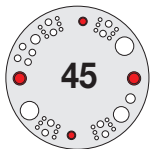

Optional - Special Order

- For best performance, we recommend using only genuine Amada punches and dies.
- Before using this machine, please read the operator's manual carefully and follow all applicable instructions.
- Always use appropriate safety equipment (that adhere to the safety regulations of your country).

ECOLOGY AND REDUCED POWER REQUIREMENTS

Even with high hit rates, the AE-NT Series requires only a 19 kVA power hookup. Average total electrical consumption during punching is less than half of a typical hydraulic machine. Unlike a hydraulic machine, no fluid change or chiller maintenance is ever required, which can save several thousand dollars per year over the life of the machine.

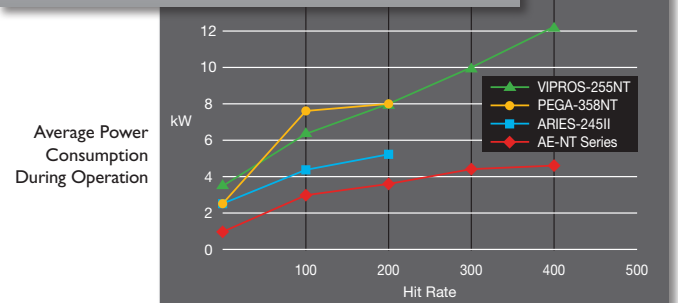
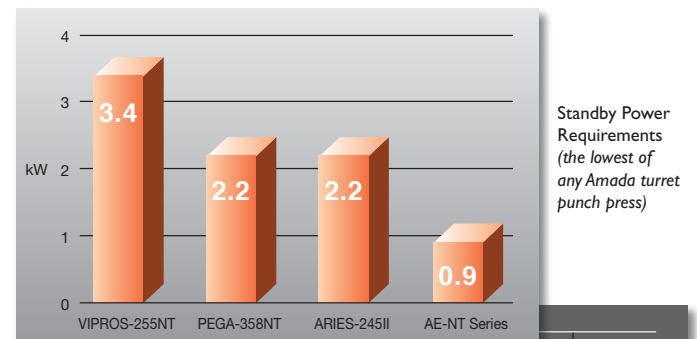

AE-NT FUNCTIONS AND MECHANISMS

RUGGED & RELIABLE SERVO RAM DRIVE

Enclosed in the bridge frame, the drive system of the AE-NT Series features a single AC servo motor with a heavy duty precision air-cooled ball screw and link assembly. The unique drive system delivers up to 370 hits per minute on 1" centers (depending on model and stroke length). The AE-NT Series also provides high-speed marking at up to 900 HPM. The drive mechanism is designed with hundreds of fewer components than any hydraulic system – resulting in greater reliability/uptime and reduced maintenance costs. The drive has been tested at over 100 million hits at full tonnage with zero failures.

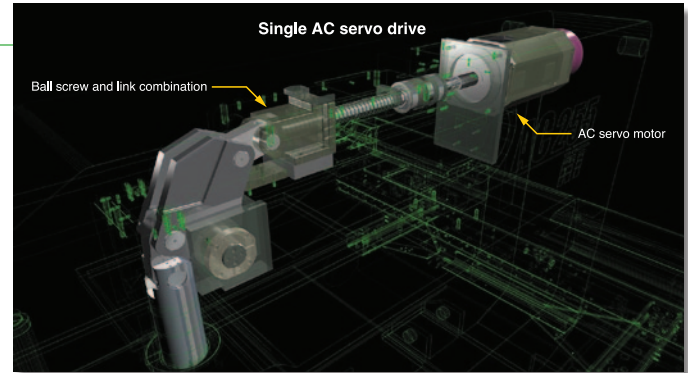

HIGHLY RIGID BRIDGE FRAME

Amada is the originator of precision-welded bridge frame construction. The stress-resistant frame utilizes 1.57" thick steel side plates to ensure stable and reliable production. The rigid foundation provides increased part accuracy, tooling life and reduced punching noise.

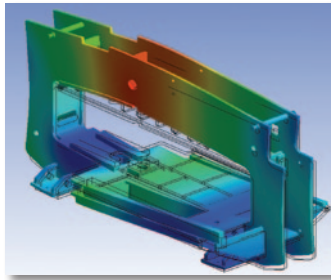

HEAVY DUTY BRUSH TABLE

All AE-NT series machines are equipped with brush tables to help reduce scratching and damage to downward forms, while significantly reducing punching noise. An optional high-density brush table allows the processing of materials up to 6.4 mm / .250" thick. Pneumatically-operated ball transfer lifters help make sheet loading easier.

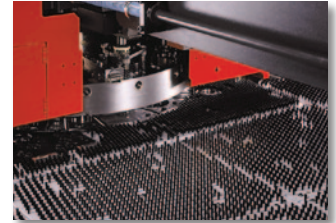

**Weight restrictions apply. Sheet weight will affect production speeds.*

LARGE CAPACITY TURRETS

The AE-NT Series features Amada's exclusive "Triple-Track" turret. Precision machined from Meehanite castings and featuring laser hardened tool bores (no sleeves required) and with up to four (4) auto-index stations. The large number of turret stations up to 4 1/2" (depending on model) means that expensive and cumbersome multi-tools are not required. High capacity enables optimum turret loading, which significantly reduces tool changes and run times – even when running multiple jobs.



PNEUMATIC TOOL BALANCER

A pneumatically-operated tool balancer provides quick, easy and safe loading and unloading of large tool stations.



SPEND MORE TIME PUNCHING WITH INTELLIGENT, RELIABLE AND EASY-TO-USE CONTROLS

To maximize productivity, the AC-NT Series is equipped with the proven Fanuc AMNC/PC control. A wide variety of touch screens allow the operator to view turret setup, job and material data and scheduling – providing faster, easier and error-free operation. An overload detection function shuts the machine down before damage can occur. Amada's powerful Dr.ABE programming and dynamic nesting software saves time and maximizes material utilization.



AMNC/PC



Tool Setup

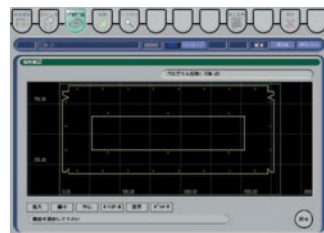

Draw and Check



Stroke Cycle Analysis

RELIABLE HIGH-SPEED PROCESSING



ELIMINATE COSTLY SLUG PULL

Amada's exclusive power vacuum die and air blow systems (both standard features of the AE-NT Series) virtually eliminate slug pull. The air blow system uses a precise mixture of air and oil that is injected into the tool through the punch body channel. The system cools and lubricates all critical components while pushing slugs down through the die. Tool life is increased by 2 to 5 times when using air blow tooling – significantly reducing tooling maintenance costs. When using power vacuum dies in 1/2" and 1 1/4" stations, air is forced into the die where it forms a powerful vacuum. Slugs are pulled downward, greatly reducing the chance of shutdowns, scrapped parts and damaged punches. In addition, punch penetration can be reduced by approximately 50%, resulting in faster hit rates and increased tool life. Amada power vacuum dies are required to take advantage of the Power Vacuum system.



Slug pull – often a problem when punching at high speeds, especially when punching small diameter holes, thin or vinyl-coated materials – has been virtually eliminated.

Part Dimensions:
35.623" x 35.623"

Material Thickness: 0.039"
Material Type:
Galvanized
Number of Parts Made:
1 per 35.63" x 35.63" sheet



AE-NT Slug Pull Prevention System

Air Blow Tool & Power Vacuum Die

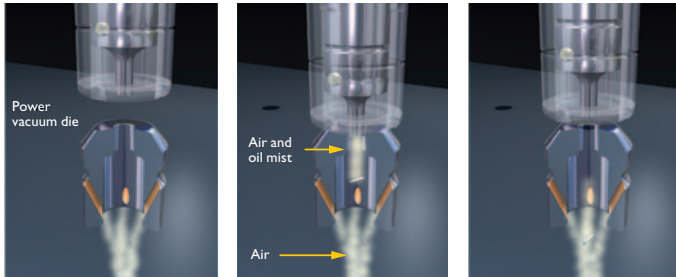

The air blow tool injects an air and oil mist into the die during punching to prevent slug sticking and pulling. The power vacuum extracts the slug down through the die.

AE-NT Slug Pull Protection Mechanism

Power Vacuum System (Standard on most models)

A powerful vacuum pulls slugs out of the die to prevent build up. Once removed, the slugs can be deposited in a bin or on a user-supplied conveyor.

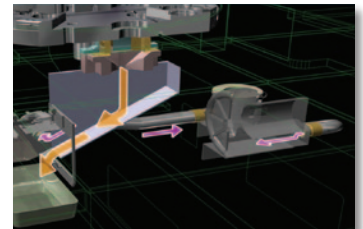

FINE CONTOURING

Fine contouring achieves near laser-like precision.

Using Amada's special contouring tool, the machine nibbles at a pitch as small as 0.020" to punch complex curves and shapes at high speeds. This is impossible with typical turret punch press tooling. As a result, secondary processes such as filing and deburring can be eliminated.

Filing not required



Part Dimensions:
17" x 15"

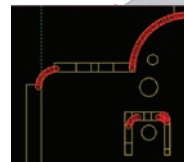

Material Thickness: 0.039"
Material Type: Galvanized
Number of Parts Made: 4 per 35.984" x 35.984" sheet

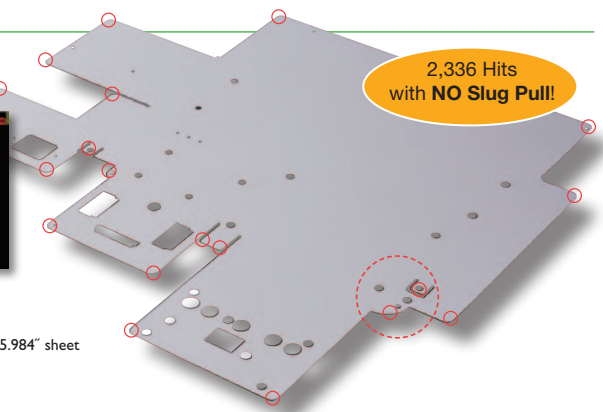

REDUCED SECONDARY OPERATION COSTS

Ask your Amada tooling sales engineer to help recommend the best solutions for your parts.

HIGH-SPEED DEBURRING

High-speed deburring dramatically reduces processing time.

Reduce costly and time-consuming, post-punch deburring by doing the work “in the sheet.” Use of the deburring tool ensures that burrs raised during the punching process are flattened – resulting in improved edge quality while streamlining the manufacturing process.

Deburring Tool
(0.393" x 0.393" sq.)

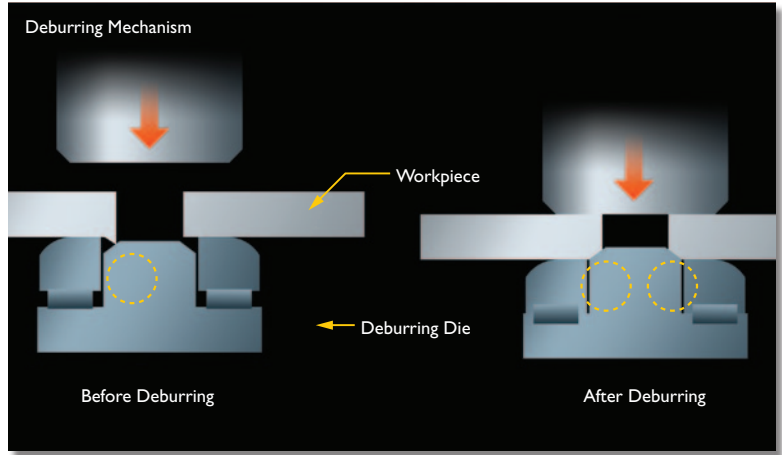

HIGH-SPEED MARKING

Capable of hit rates up to 900 HPM, the high-speed marking tool reduces secondary operation time by adding part names, part numbers, bend lines, weld locations and other information. Punch penetration depth is accurately controlled so that the marks can be subsequently covered by paint, powder coat, etc.

Part Dimensions: 7.8" x 3.3"

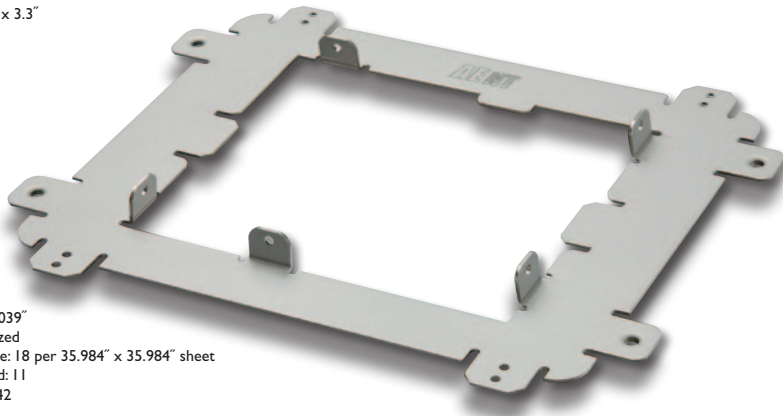

Material Thickness: 0.039"
Material Type: Galvanized
Number of Parts Made: 18 per 35.984" x 35.984" sheet
Number of Tools Used: 11
Number of Hits: 27,342



Marking Tool

Feed Pitch: .020"
Punch Penetration: 0.008"

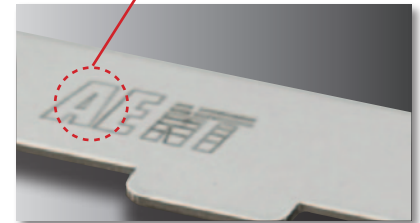

HIGH-SPEED FORMING

Parts can easily and quickly be formed to desired shapes and dimensions with progressive tools. Previously, punching and forming often required separate operations. Now, offset bends, extrusions, ribs and other forms can be added at high speeds using progressive tools in the auto-index stations.

Offset Bending



Offset Bending Tools



Progressive Ribbing



Ribbing Tools



Progressive Extrusion



Extrusion Tool



DIMENSIONS

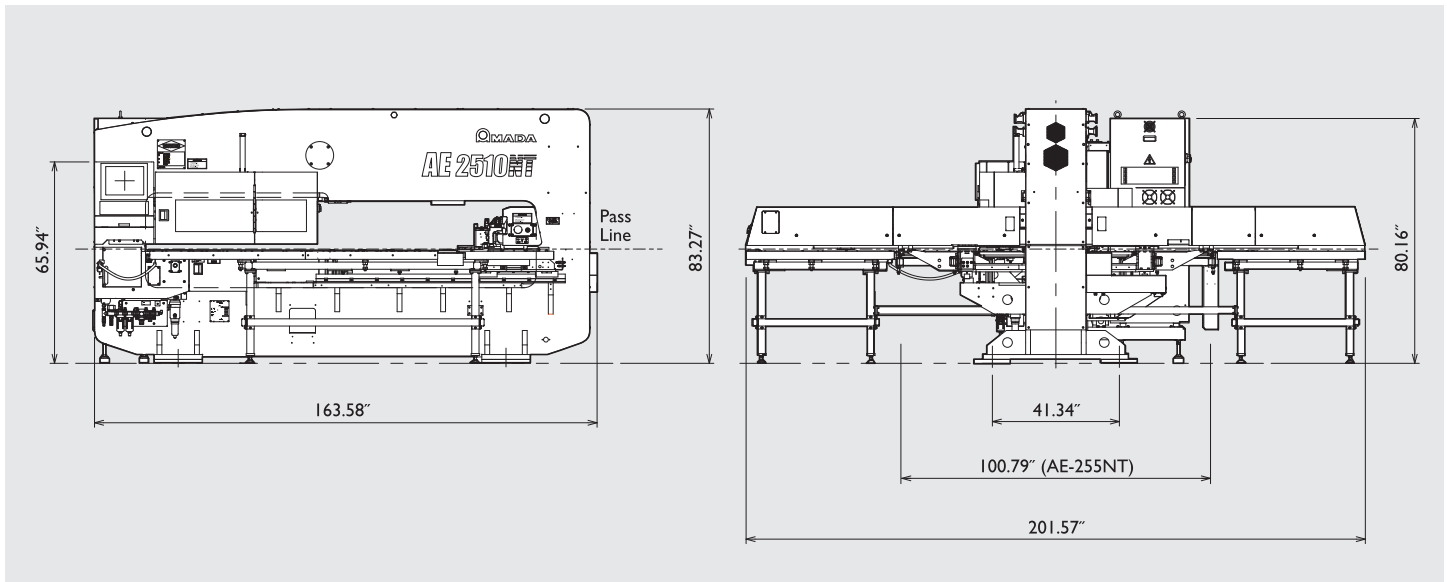

SPECIFICATIONS

Machine	AE-2510NT	AE-255NT
Tonnage	20 metric / 22 U.S.	
Press Drive System	Single motor AC servo drive	
Maximum Stroke Length	42 mm / 1.65"	
Maximum Thickness (see material, weight restrictions below)	3.2 mm / 0.12" (standard brush table) 6.4 mm / 0.25" (high density brush table - <i>OPTIONAL</i>)	
Travel Range (w/o reposition)	1270 mm x 2500 mm / 50" x 98.4"	1270 mm x 1270 mm / 50" x 50"
Maximum Feed Rate	X axis: 80 m per min. / 3,150" per min. • Y axis: 60 m per min. / 2,362" per min.	
Maximum Weight of Material	50 kg / 110 lbs. (F1 speed) • 150 kg / 331 lbs. (F4 speed)	
Maximum Hit Rate	X Axis 350 HPM • Y Axis 280 HPM (on 1" pitch at 0.118" stroke) 900 HPM (at 0.019" pitch and 0.055" stroke) for marking pattern	X Axis 370 HPM • Y Axis 275 HPM (on 1" pitch at 0.118" stroke) 900 HPM (at 0.019" pitch and 0.055" stroke) for marking pattern
Punching Accuracy	± .1 mm / 0.004" and ± .07 mm / 0.002" (Fine Accuracy mode)	
Turret Rotation Speed	30 rpm	
Auto-Index Rotation Speed	60 rpm	
NC Control	AMNC/PC	
Power Requirement	19 kVA	
Maximum Air Consumption	750 NI/min. / 2.7 cubic feet	
Mass of Machine	13 metric tons / 28,660 lbs.	12 metric tons / 26,400 lbs.

In our ongoing efforts to improve performance, specifications, features and equipment appearance are subject to change without notice. Note: AE2510NT, AE2555NT and MPI225NJ are the official machine names and models numbers for legal applications, such as machine installation permit, import/export permit and financing application.