



By Ormesa



201 Growth Parkway Angola, IN 46703

Canadian Suggested Retail Price List in USD

Phone: 260-665-2769

Jan-18

Fax: 260-665-3047

Email: iim@mobility-usa.com

www.mobility-usa.com

Quote: _____

P.O. _____

Bill To

Dealer: _____ Contact: _____

Address: _____

City: _____ State: _____ Zip: _____

Phone: _____ Fax: _____

Email: _____ Mark For: _____

Ship To Same as Bill To _____

Dealer: _____ Contact: _____

Address: _____

City: _____ State: _____ Zip: _____

Phone: _____ Fax: _____

Email: _____ Mark For: _____

Novus Features and Specifications

- **Frame** - foldable aluminum, bronze painted with non-toxic epoxy bronze powders
- **Blue Upholstery** - padded, ergonomic & removable; wear, water and fire proof fabric; designed to make the change of accessories easier without causing trouble to the child while seated
- **Backrest** - adjustable in height and tilt
- **Seat Bottom** - adjustable in width and depth
- **Legrest** - adjustable in tilt, with a quick release mechanism; flip-up footrest adjustable in tilt
- **Wheels** - snap-on, sliding on ball bearings; front wheel 7" and puncture-proof rear wheel 12" with independent drum brakes

Novus

Part Number	Description	Price (USD)	HCPCS
____ NN-2	Novus 2	\$3,300.00	E1236
____ NN-3	Novus 3	\$3,400.00	E1236
____ NN-4	Novus 4	\$3,500.00	E1236











Footrest Options



Part Number	Description	Price (USD)	HCPCS
____ 827	Foot Straps 8"-11"	\$70.00	E0951
____ 827A	Foot Straps 11"-14"	\$80.00	E0951
____ 817-1	Leg Straps 2	\$135.00	K0038
____ 817-3	Leg Straps 3 & 4	\$135.00	K0038
____ NB892-1/2	Padded Footplate Covering 2	\$100.00	K0108
____ NB892-3/4	Padded Footplate Covering 3 & 4	\$100.00	K0108













Positioning Options

Part Number	Description	Price (USD)	HCPCS	
____ NN838-2	Adjustable Lateral Supports 2	\$260.00	E0956	
____ NN838-3	Adjustable Lateral Supports 3	\$260.00	E0956	
____ NN838-4	Adjustable Lateral Supports 4	\$260.00	E0956	
____ 853	Vest Harness 2	\$175.00	E0960	
____ 853-3	Vest Harness 3 & 4	\$175.00	E0960	
____ 894-1	45° Pelvic Belt 2	\$95.00	E0978	
____ 894-3	45° Pelvic Belt 3 & 4	\$95.00	E0978	
____ 906-1	Five Point Harness 2	\$130.00	E0960	
____ 906-3	Five Point Harness 3 & 4	\$130.00	E0960	
____ NN868-2	Wrappable and Flexible Trunk Supports 2	\$430.00	E0956	
____ NN868-3	Wrappable and Flexible Trunk Supports 3 & 4	\$430.00	E0956	
____ NN834-2	Padded Abduction Block 2	\$140.00	E0957	
____ NN834-3	Padded Abduction Block 3	\$140.00	E0957	
____ NN834-4	Padded Abduction Block 4	\$140.00	E0957	
____ NN852-2	Headrest with Parietal Supports 2 & 3	\$290.00	E0955	
____ NN852-4	Headrest with Parietal Supports 4	\$290.00	E0955	
____ NN863-2	Headrest with Occipital-Parietal Supports 2 & 3 requires NN863-HW	\$290.00	E0955	
____ NN863-4	Headrest with Occipital-Parietal Supports 4 requires NN863-HW	\$290.00	E0955	
____ NN863-HW	Headrest Hardware	\$265.00	E1028	

Accessories

Part Number	Description	Price (USD)	HCPCS	
____ NN812	Wheel directional locks	\$160.00	K0108	
____ 818	Black Thermal Cover 2	\$375.00	K0108	
____ 818-3	Black Thermal Cover 3 & 4	\$375.00	K0108	
____ NN819-2	Black Canopy 2 requires NN819-HW	\$300.00	K0108	
____ NN819-3	Black Canopy 3 requires NN819-HW	\$300.00	K0108	
____ NN819-4	Black Canopy 4 requires NN819-HW	\$300.00	K0108	
____ NN819-HW	Canopy Hardware	\$125.00	E1028	

Accessories Continued

Part Number	Description	Price (USD)	HPCPS	
<u> </u> NB854-BL	Blue Umbrella	\$140.00	K0108	
<u> </u> NN825-2	Black Rain Cover 2 & 3 requires 819	\$175.00	K0108	
<u> </u> NN825-4	Black Rain Cover 4 requires 819	\$175.00	K0108	
<u> </u> NN839-2	Front Handle 2	\$260.00	K0108	
<u> </u> NN839-3	Front Handle 3	\$260.00	K0108	
<u> </u> NN839-4	Front Handle 4	\$260.00	K0108	
<u> </u> NN824-2	Transparent Table with Edge & Hollow 2 requires NN824-HW	\$200.00	E0950	
<u> </u> NN824-3	Transparent Table with Edge & Hollow 3 requires NN824-HW	\$200.00	E0950	
<u> </u> NN824-4	Transparent Table with Edge & Hollow 4 requires NN824-HW	\$200.00	E0950	
<u> </u> NN824-HW	Adjustable and Removable Table Hardware	\$150.00	E1028	
<u> </u> NN844	Side Protecting Covers	\$150.00	K0108	
<u> </u> NN905-2	Hand Brake 2	\$475.00	K0108	
<u> </u> NN905-3	Hand Brake 3	\$475.00	K0108	
<u> </u> NN905-4	Hand Brake 4	\$475.00	K0108	
<u> </u> 858	Medical Necessity Basket Not compatible with NB927	\$125.00	K0108	
<u> </u> NN927-2	Vent Tray 2 Not compatible with 858	\$650.00	E1029	
<u> </u> NN927-3	Vent Tray 3 & 4 Not compatible with 858	\$650.00	E1029	
<u> </u> 891	Tie Down Hooks	\$275.00	K0108	
Intended for forward-facing transport of the pushchair in a motor vehicle. Conforms with ISO 7176/19 and ANSI RESNA WC/19.				
<u> </u> 922	Bottle Holder	\$45.00	K0108	

Client Measurements

A Back height: _____ F Lower leg length: _____
 B Chest depth: _____ G Head height: _____
 C Chest width: _____ H Arm height: _____
 D Seat depth: _____ Age: _____
 E Seat width: _____ Weight: _____

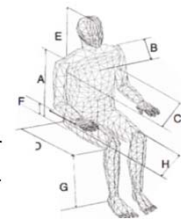

Dimensions

Measurements in Inches

Novus	Size 2	Size 3	Size 4
Max Capacity	99 lbs	121 lbs	143 lbs
User Height	49 - 57	51 - 61	57 - 66.5
Unit Weight	43 lbs	46 lbs	49 lbs
A	16	17	18
B	8 - 12	9.5 - 13	11 - 15
C	12 - 14	14 - 16	15 - 18
D	10.5 - 14.5	12 - 16	12 - 17
E	25.5 - 28	28 - 31.5	29.5 - 32
F	40.5	41.5	42
G	23.5	25	26
H	34	36.5	38
M	16	16	16.5
N	40	41	43
O	22.5	23.5	24.5
P	32.5	33	35.5

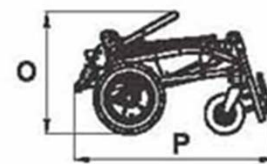
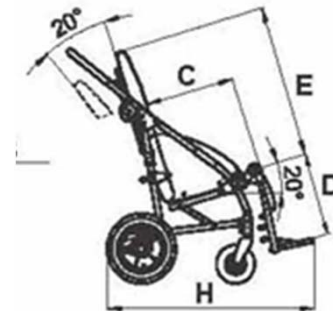
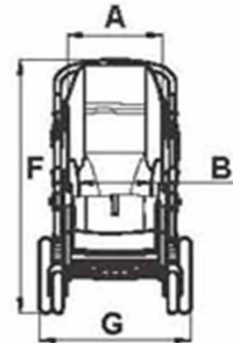

Note: All specification and prices are subject to change without notice. Prices listed are only valid if ordering with a stroller. The HCPCS codes provided are not intended to be billing or legal advice, rather Innovation In Motion's interpretation of the code definitions. Use of the codes provided does not ensure coverage or payment for the item. For coverage information, verify the policy of the appropriate payer. It is recommended to contact Innovation In Motion with any questions regarding proper ordering of the chair at 1-260-665-2769.