

WASHERS

USS FLAT WROUGHT WASHERS

- Specially engineered to insure ultimate clamping force.
- Burr-free -- uniform thickness.

PLATED FINISH		
J&B #	SIZE	QTY
25136	3/16	100
8420	3/16	500
8421	1/4	250
24010	1/4	100
8422	5/16	200
24011	5/16	100
8198	3/8	200
8423	3/8	100
8199	7/16	200
8424	7/16	100
8425	1/2	50
24012	1/2	100
8426	9/16	50
8427	5/8	25
24013	5/8	50
8428	3/4	25
24014	3/4	50
8429	7/8	20

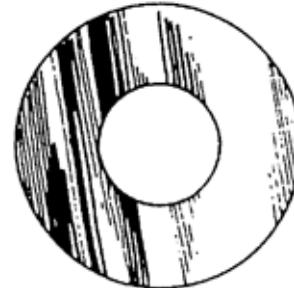

PLATED FINISH		
J&B #	SIZE	QTY
8430	1	10
24015	1	25
8431	1-1/8	10
8432	1-1/4	10
24016	1-1/4	25
25137	1-3/8	25
8433	1-1/2	10
8434	1-3/4	5
8435	2	5

USS HIGH ALLOY FLAT WASHERS

Yellow Zinc Plated
GRADE 8

J&B #	SIZE	QTY
39524	1/4	100
39525	5/16	100
39526	3/8	100
39527	7/16	50
39528	1/2	50
39529	9/16	50
39530	5/8	25
39531	3/4	20
39532	7/8	15
39533	1	10
39534	1-1/8	10
39535	1-1/4	5
39536	1-3/8	5
39537	1-1/2	5

WASHERS

SAE FLAT WASHERS

- Perfectly round -- burr free.
- Eliminate downtime due to bending & dishing.

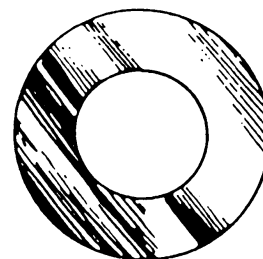

PLATED FINISH		
J&B #	SIZE	QTY
24035	# 4	500
25007	# 6	100
24036	# 6	500
25008	# 8	100
24037	# 8	500
25009	# 10	100
8440	# 10	500
10812	# 12	100
8441	1/4	250
24038	1/4	100
8442	5/16	200
24039	5/16	100
8195	3/8	200
8443	3/8	100

PLATED FINISH		
J&B #	SIZE	QTY
8196	7/16	200
8444	7/16	100
8445	1/2	50
24040	1/2	100
8446	9/16	50
8447	5/8	25
24041	5/8	50
8448	3/4	25
24042	3/4	50
24045	7/8	50
8449	7/8	20
8450	1	10
24043	1	50
8451	1-1/8	10
* 24044	1-1/4	25

* Plain Finish

SAE HIGH ALLOY WASHERS

Yellow Zinc/Grade 8

PLATED FINISH		
J&B #	SIZE	QTY
39544	1/4	100
39545	5/16	100
39546	3/8	100
39547	7/16	50
39548	1/2	50
39549	9/16	50
39550	5/8	25
39551	3/4	20
39552	7/8	15
39553	1	10
39554	1-1/8	20
* 8471	1-1/4	25
39556	1-3/8	10
* 8472	1-1/2	25
39557	1-3/4	10
39558	2	10

* Plain Finish

SAE L9 TENSION WASHER

Yellow Zinc

PLATED FINISH		
J&B #	SIZE	QTY
8460	1/4	100
8461	5/16	100
8462	3/8	100
8463	7/16	50
8464	1/2	50
8465	9/16	50
8466	5/8	50
8467	3/4	40
8468	7/8	30
8469	1	20

WASHERS

EXTRA THICK WASHERS

- Designed for high performance in the most rugged environments.
- Through hardened carbon steel.
- Zinc plated finish protects against rust and corrosion.
- Extra thickness helps to prevent splitting, bellying and dishing.
- Eliminates bolt failure caused by ordinary flat washers “dishing out” and allowing assembly to vibrate loose.



USS WASHERS				
J&B #	SIZE	O.D.	THICK.	QTY
45684	7/16	1-1/4"	.150"	100
V45674	1/2	1-3/8"	.199"	100
V45675	9/16	1-1/2"	.199"	50
V45676	5/8	1-3/4"	.250"	50
V45677	3/4	2"	.250"	25
V45678	7/8	2-1/4"	.250"	25
V45679	1"	2-1/2"	.250"	25
45721	1-1/8"	2-3/4"	.310"	10
45722	1-1/4"	3"	.310"	10
45723	1-1/2"	3-1/2"	.310"	10

SAE WASHERS				
J&B #	SIZE	O.D.	THICK.	QTY
45571	1/4	.600	.093"	100
45573	5/16	.670	.096"	100
45663	3/8	.789	.116"	100
45666	7/16	.900	.122"	100
V45667	1/2	1-1/16"	.199"	100
V45668	9/16	1-3/16"	.199"	50
V45669	5/8	1-5/16"	.250"	50
V45671	3/4	1-1/2"	.250"	25
V45672	7/8	1-3/4"	.250"	25
V45673	1"	2"	.250"	25
45574	1-1/4"	2-1/2"	.310"	10

MEASURING CHART

SAE FLAT WASHERS



3/16



1/4



5/16



3/8



7/16



1/2



9/16



5/8



3/4

Illustrations are actual size

USS WROUGHT WASHERS



3/16



1/4



5/16



3/8



7/16



1/2



9/16

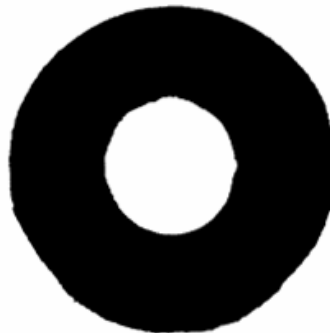

5/8



3/4

Illustrations are actual size

LOCK WASHERS

HELICAL SPRING LOCK WASHERS

Carbon Steel



- Developed to eliminate loose bolt problems and assembly failures.
- Add strength and insure against equipment breakdown; non-linking, positive locking.

PLATED FINISH		
J&B #	SIZE	QTY
24090	# 4	100
24030	# 6	100
24031	# 8	100
8402	# 10	100
8403	# 12	100
8404	1/4	100
8405	5/16	100
8406	3/8	100
8407	7/16	100
8408	1/2	100
8409	9/16	100
8410	5/8	50
8411	3/4	50
8412	7/8	25
8413	1	25

PLATED FINISH		
J&B #	SIZE	QTY
24032	# 6	500
24033	# 8	500
24034	# 10	500
24020	1/4	500
24021	5/16	500
24022	3/8	200
24023	7/16	200
24024	1/2	200
24025	5/8	100
24026	3/4	100
24027	7/8	50
24028	1	50
* 8414	1-1/8	20
* 8415	1-1/4	20
* 8416	1-3/8	10
* 8417	1-1/2	10
* 8418	1-3/4	5
* 8419	2	5

* Plain Finish

HELICAL SPRING LOCK WASHERS

High Alloy/Yellow Zinc
GRADE 8

PLATED FINISH		
J&B #	SIZE	QTY
39504	1/4	100
39505	5/16	100
39506	3/8	100
39507	7/16	50
39508	1/2	50
39509	9/16	50
39510	5/8	50
39511	3/4	25
39512	7/8	25
39513	1	25
* 39514	1-1/8	5
* 39515	1-1/4	5
* 39516	1-3/8	5
* 39517	1-1/2	5

* NOT HIGH ALLOY
(SUITABLE FOR GR 5
AND GR 8 APPLICATIONS)

WASHERS

EXTERNAL LOCK WASHERS

- Cadmium plated to protect against rust and corrosion.
- Should be used when maximum holding power is needed.
- Heads should be large enough to contact the teeth, such as round, pan and binding heads.



J&B #	SIZE	QTY
10969	# 4	100
10970	# 6	100
10971	# 8	100
10972	# 10	100
10973	# 12	100
10974	1/4	100
10975	5/16	100
10976	3/8	50
10977	7/16	50
10978	1/2	50
10979	9/16	50
10980	5/8	50
10981	3/4	25
10982	7/8	25
10983	1	25

INTERNAL LOCK WASHERS

- Cadmium plated to protect against rust and corrosion.
- Use where appearance warrants that teeth be hidden and to prevent snagging or scratching.
- Teeth lock into screw head or nut to prevent backoff rotation.



J&B #	SIZE	QTY
11070	# 4	100
11071	# 6	100
11072	# 8	100
11073	# 10	100
11074	# 12	100
11075	1/4	100
11076	5/16	100
11077	3/8	50
11078	7/16	50
11079	1/2	50
11080	9/16	50
11081	5/8	50
11082	3/4	25
11083	7/8	25
11084	1	25



WASHERS

COUNTERSUNK EXTERNAL LOCK WASHERS

- Plated to protect against rust and corrosion.
- Used with either flat or oval head screws in either 82 or 100 degree countersunk angles.
- Use for applications that require concealed teeth.



J&B #	SIZE	QTY
11085	# 6	100
11086	# 8	100
11087	# 10	100
11089	1/4	50
11090	5/16	50

HIGH COLLAR LOCK WASHERS

(Used with Hex Socket Cap Screws)

- Springs back to normal position without loss of locking power.
- Non-linking.



J&B #	SIZE	QTY
24102	# 8	100
24087	# 10	100
24095	1/4	100
24096	5/16	100
24097	3/8	100
24104	7/16	100
24098	1/2	100
24099	5/8	50
24105	3/4	50
24106	1"	25

STEEL SQUARE BEVELED WASHERS

- Intended for structural and mechanical uses such as shimming and leveling.

J&B #	SIZE	QTY
24091	3/8	50
24092	1/2	50
24093	5/8	25
24094	3/4	25

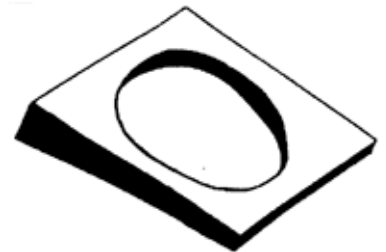

WASHERS

DISC-LOCK WASHERS

- Consists of identical lock washers each having a series of inclined cams on one side and radial teeth on the other.
- Self-locking fasteners; even self-tightening if subjected to vibration.

J&B #	SIZE	QTY
11750	3/16" - 5MM	50 (25 pair)
11751	1/4" - 6MM	50 (25 pair)
11752	5/16" - 8MM	50 (25 pair)
11753	3/8" - 10MM	50 (25 pair)
11754	7/16" - 11MM	30 (15 pair)
11755	1/2" - 12MM	20 (10 pair)
11756	9/16" - 14MM	20 (10 pair)
11757	5/8" - 16MM	10 (5 pair)
11758	3/4" - 19MM	10 (5 pair)
11760	1" - 25MM	10 (5 pair)

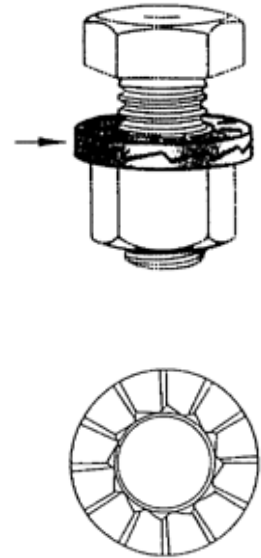

COUNTERSUNK FINISHING WASHER

- Provide a finished, well-rounded appearance with no jagged edges.
- Use with flat and oval-head countersunk screws.

PLATED FINISH		
J&B #	SIZE	QTY
10957	# 8	50
10958	# 10	50



FLUSH FINISHING WASHER

- Provides a finished appearance for places where fasteners can't be hidden.

PLATED FINISH		
J&B #	SIZE	QTY
10953	# 8	50



WASHERS

FENDER WASHERS

Zinc Plated

- Specifically designed for application where a larger bearing is required.
- Smooth surface; free from burrs.
- **Uniform** thickness.

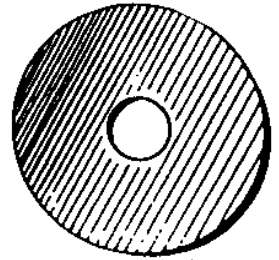

J&B #	I. D.	O. D.	QTY
41383	1/8	5/8	100
11142	3/16	3/4	100
25139	3/16	1	100
25010	3/16	1-1/4	100
11143	1/4	1	100
24018	1/4	1-1/4	100
41378	1/4	1-1/2	100
41367	1/4	2	50
11144	5/16	1-1/4	100
24019	5/16	1-1/2	100
41368	5/16	2	50
41422	3/8	1-1/4	100
11145	3/8	1-1/2	100
11146	3/8	2	50
41423	1/2	1-1/2	50
25011	1/2	2	50
41426	5/8	1-3/4	25

EXTRA THICK FENDER WASHERS

Zinc Plated

- Zinc plated for excellent corrosion resistance.
- Used to repair sloppy holes.
- Extra thickness allows for higher bolt torque without washer deformation.

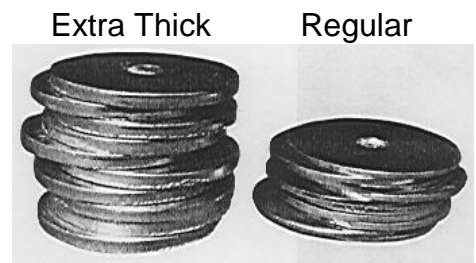

J&B #	I. D.	O.D.	THICKNESS	QTY
45600	1/4	1	.120	50
45601	1/4	1-1/2	.120	50
45602	5/16	1-1/4	.120	50
45603	5/16	1-3/4	.120	50
45604	3/8	1-1/4	.120	50
45605	3/8	1-3/4	.120	50
45606	1/2	2	.120	50

WASHERS

NATURAL NYLON FLAT WASHERS



J&B #	BOLT SIZE	I. D.	O. D.	THICKNESS	QTY
39330	1/16	.140	.312	.062	100
39331	1/8	.171	.375	.062	100
39332	1/8	.200	.437	.062	100
39333	3/16	.242	.375	.062	100
39334	3/16	.257	.500	.062	100
39335	1/4	.317	.500	.062	100
39336	1/4	.317	.750	.062	50
39337	5/16	.390	.750	.062	50
39338	5/16	.343	.885	.062	50
39339	3/8	.443	.750	.062	50
39340	3/8	.406	1.000	.062	25

COPPER WASHERS



J&B #	BOLT SIZE	I. D.	O. D.	THICKNESS	QTY
39990	3/16	1/4	7/16	1/32	50
39991	3/16	1/4	5/8	1/16	25
39992	1/4	5/16	1/2	1/32	50
39993	1/4	5/16	11/16	1/16	25
39994	5/16	3/8	9/16	1/32	50
39995	5/16	3/8	3/4	1/16	25
39996	3/8	7/16	13/16	1/16	25
39997	7/16	1/2	7/8	1/16	25
39998	1/2	9/16	13/16	3/32	25















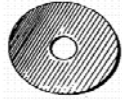

J&B Fleet - Industrial Supply

www.jbfleet.com

22428 Harrisburg-Westville Rd. Alliance, Ohio 44601 Phone: (330) 821-6342 Fax: (330) 821-0411

PART # 2196

FENDER WASHERS

<p>25010</p>  <p>3/16 ID X 1-1/4 OD</p> <p>50</p>	<p>11144</p>  <p>5/16 ID X 1-1/4 OD</p> <p>25</p>	<p>11145</p>  <p>3/8 ID X 1-1/2 OD</p> <p>25</p>	<p>25011</p>  <p>1/2 ID X 2 OD</p> <p>25</p>
<p>25139</p>  <p>3/16 ID X 1" OD</p> <p>50</p>	<p>41378</p>  <p>1/4 ID X 1-1/2 OD</p> <p>25</p>	<p>41422</p>  <p>3/8 ID X 1-1/4 OD</p> <p>25</p>	<p>41423</p>  <p>1/2 ID X 1-1/2 OD</p> <p>25</p>
<p>11142</p>  <p>3/16 ID X 3/4 OD</p> <p>50</p>	<p>24018</p>  <p>1/4 ID X 1-1/4 OD</p> <p>25</p>	<p>24019</p>  <p>5/16 ID X 1-1/2 OD</p> <p>25</p>	<p>11146</p>  <p>3/8 ID X 2" OD</p> <p>25</p>
<p>41383</p>  <p>1/8 ID X 5/8 OD</p> <p>50</p>	<p>11143</p>  <p>1/4 ID X 1" OD</p> <p>50</p>		

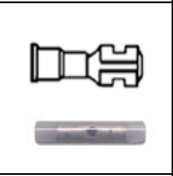



J&B Fleet - Industrial Supply







www.jbfleet.com

22428 Harrisburg-Westville Rd. Alliance, Ohio 44601 Phone: (330) 821-6342 Fax: (330) 821-0411

PART # 2233

THICK FENDER WASHERS



<p>45600 1</p>  <p>1/4 I.D. - 1 O.D. .120 THICKNESS</p> <p>10</p>	<p>45601 2</p>  <p>1/4 I.D. - 1-1/2 O.D. .120 THICKNESS</p> <p>10</p>	<p>3</p>
<p>45602 4</p>  <p>5/16 I.D. - 1-1/4 O.D. .120 THICKNESS</p> <p>10</p>	<p>45603 5</p>  <p>5/16 I.D. - 1-3/4 O.D. .120 THICKNESS</p> <p>10</p>	<p>6</p>
<p>45604 7</p>  <p>3/8 I.D. - 1-1/4 O.D. .120 THICKNESS</p> <p>10</p>	<p>45605 8</p>  <p>3/8 I.D. - 1-3/4 O.D. .120 THICKNESS</p> <p>10</p>	<p>9</p>
<p>10</p>	<p>45606 11</p>  <p>1/2 I.D. - 2 O.D. .120 THICKNESS</p> <p>10</p>	<p>12</p>





































J&B Fleet - Industrial Supply

22428 Harrisburg-Westville Rd. Alliance, Ohio 44601 Phone: (330) 821-6342 Fax: (330) 821-0411

www.jbfleet.com

PART # 2015

SHAKEPROOF WASHERS

 10970 1 #6 FLAT EXTERNAL TOOTH 25	 10971 2 #8 FLAT EXTERNAL TOOTH 25	 10972 3 #10 FLAT EXTERNAL TOOTH 25	 10973 4 #12 FLAT EXTERNAL TOOTH 25	 10974 5 1/4 FLAT EXTERNAL TOOTH 25	 10975 6 5/16 FLAT EXTERNAL TOOTH 25	 10976 7 3/8 FLAT EXTERNAL TOOTH 10	 11086 8 #8 COUNTERSUNK EXTERNAL TOOTH 25
 10977 9 7/16 FLAT EXTERNAL TOOTH 10	 10978 10 1/2 FLAT EXTERNAL TOOTH 10	 10979 11 9/16 FLAT EXTERNAL TOOTH 10	 10980 12 5/8 FLAT EXTERNAL TOOTH 10	 10981 13 3/4 FLAT EXTERNAL TOOTH 10	 10982 14 7/8 FLAT EXTERNAL TOOTH 10	 10983 15 1 FLAT EXTERNAL TOOTH 10	 11087 16 #10 COUNTERSUNK EXTERNAL TOOTH 25
 11071 17 #6 FLAT INTERNAL TOOTH 25	 11072 18 #8 FLAT INTERNAL TOOTH 25	 11073 19 #10 FLAT INTERNAL TOOTH 25	 11074 20 #12 FLAT INTERNAL TOOTH 25	 11075 21 1/4 FLAT INTERNAL TOOTH 25	 11076 22 5/16 FLAT INTERNAL TOOTH 25	 11077 23 3/8 FLAT INTERNAL TOOTH 10	 11089 24 1/4 COUNTERSUNK EXTERNAL TOOTH 25
 11078 25 7/16 FLAT INTERNAL TOOTH 10	 11079 26 1/2 FLAT INTERNAL TOOTH 10	 11080 27 9/16 FLAT INTERNAL TOOTH 10	 11081 28 5/8 FLAT INTERNAL TOOTH 10	 11082 29 3/4 FLAT INTERNAL TOOTH 10	 11083 30 7/8 FLAT INTERNAL TOOTH 10	 11084 31 1 FLAT INTERNAL TOOTH 10	 11090 32 5/16 COUNTERSUNK EXTERNAL TOOTH 25

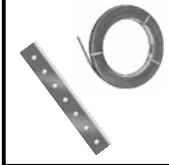

LET US HELP YOU MAKE THE CONNECTION

PART # 3021



SHAKEPROOF WASHERS



J & B FLEET-INDUSTRIAL SUPPLY
PHONE: 330-821-6342

10971 # 8 FLAT External Tooth 25	10972 # 10 FLAT External Tooth 25	10974 1/4 FLAT External Tooth 25	10975 5/16 FLAT External Tooth 10	10976 3/8 FLAT External Tooth 10	10977 7/16 FLAT External Tooth 10
10978 1/2 FLAT External Tooth 10	10980 5/8 FLAT External Tooth 5	10981 3/4 FLAT External Tooth 5	11072 # 8 FLAT Internal Tooth 25	11073 # 10 FLAT Internal Tooth 25	11075 1/4 FLAT Internal Tooth 25
11076 5/16 FLAT Internal Tooth 10	11077 3/8 FLAT Internal Tooth 10	11078 7/16 FLAT Internal Tooth 10	11079 1/2 FLAT Internal Tooth 5	11081 5/8 FLAT Internal Tooth 5	11082 3/4 FLAT Internal Tooth 5



J&B Fleet - Industrial Supply

22428 Harrisburg-Westville Rd. Alliance, Ohio 44601 Phone: (330) 821-6342 Fax: (330) 821-0411

www.jbfleet.com

PART # 2054

DISC LOCK WASHERS

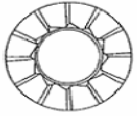
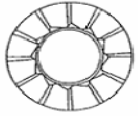
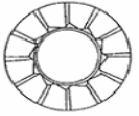
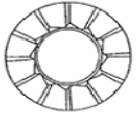
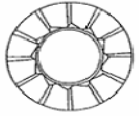
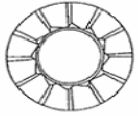
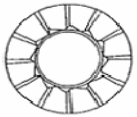
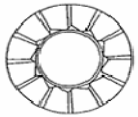
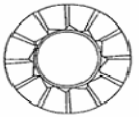
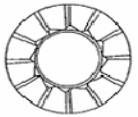
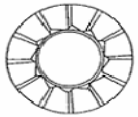

 11750 3/16"	 11751 1/4"	 11752 5/16"	 11753 3/8"	 11754 7/16"	 11755 1/2"
 11756 9/16"	 11757 5/8"	 11758 3/4"	 11759 7/8"	 11760 1"	

DISC-LOCK WASHERS

The Disc-Lock fasteners are unique in that they are truly self-locking and if subjected to vibration, normally even self-tightening.

THE DISC-LOCK PRINCIPLE

Disc-Lock consists of a pair of identical lock washers, each having a series of inclined cams on one side and radial teeth on the other. The rise of the cams is greater than the rise of the threads of the fastener.

The washer pair is installed cam face to cam face between a nut or cap screw and the joint material. When tightening the fastener, the teeth bite into the nut on one side and the joint material on the other. If the nut attempts to rotate loose, the mating washer "climbs" up the cams of the other washer resulting in an increased clamping load.

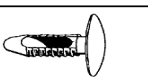

PART # 3079

LET US HELP YOU MAKE THE CONNECTION



NYLON FLAT WASHERS



J & B FLEET-INDUSTRIAL SUPPLY
PHONE: 330-821-6342

39330 1/16 .140 ID .312 OD 20	39331 1/8 .171 ID .375 OD 20	39332 1/8 .200 ID .437 OD 20	39333 3/16 .242 ID .375 OD 20	39334 3/16 .257 ID .500 OD 20	39335 1/4 .317 ID .500 OD 20
39336 1/4 .317 ID .750 OD 10	39337 5/16 .390 ID .750 OD 10	39338 5/16 .343 ID .875 OD 10	39339 3/8 .443 ID .750 OD 10	39340 3/8 .406 ID 1.000 OD 5	

LET US HELP YOU MAKE THE CONNECTION

PART#3100



COPPER WASHERS



J & B FLEET-INDUSTRIAL SUPPLY
PHONE: 330-821-6342

39990 3/16" BOLT 1/4" ID 7/16" OD 10	39991 3/16" BOLT 1/4" ID 5/8" OD 10	39992 1/4" BOLT 5/16" ID 1/2" OD 10	39993 1/4" BOLT 5/16" ID 11/16" OD 10	39994 5/16" BOLT 3/8" ID 9/16" OD 10	39995 5/16" BOLT 3/8" ID 3/4" OD 10
39996 3/8" BOLT 7/16" ID 13/16" OD 10	39997 7/16" BOLT 1/2" ID 7/8" OD 10	39998 1/2" BOLT 9/16" ID 13/16" OD 10			