

HYDRAULICS INDEX

ADAPTERS (STEEL)

37° Flare.....	769-778
37° Flare (with O-Ring).....	775-776B
Female Pipe Swivel.....	782-784
Ferulok.....	787
Metric Adapters.....	777-778A
Pipe.....	779-784
Seal Lok.....	785-786
Stainless Adapters.....	774A

FITTINGS

20 Series.....	749-754
22 Series.....	757
26 Series (Air Conditioning).....	748K-748P
30 Series.....	760-761
43 Series.....	740-745
55 Series.....	746-747A
71 Series.....	748-748C
78 Series.....	748E-748J
Caterpillar Style.....	748H-748J
88 Series.....	764
90 Series.....	767
91 Series.....	768-768A
Ferulok.....	787
Stainless Fittings.....	745A, 766

HOSES

LOW PRESSURE

285 "Air Conditioning".....	737
881/811 "Suction & Return Lines".....	720

MEDIUM PRESSURE

201 "Hi-Temperature".....	726
426HT "Hi-Temperature".....	724
518C "Non-Conductive".....	734

NOTES

- ^ Bend radius is measured from center of the bend to inside edge of hose.
^^ Jack Hose available 1/4" & 3/8" under part#'s 50220 (JK-4) & 50221 (JK-6).

919 "TFE Stainless".....	736
--------------------------	-----

HIGH PRESSURE

SS25UL "LPG".....	728
302/301 High Pressure.....	730
387TC Tough Cover.....	732
471TC Tough Cover.....	733
487TC Tough Cover.....	731
772TC High Pressure.....	733B
78C High Pressure.....	733C
Pressure Washer.....	798

MISCELLANEOUS

Armor Guards.....	795
Caplugs.....	796-797
Code 61 Plugs.....	776B
Flaretite Seals.....	768B
Hose Fitting Thread Guide.....	719
Partek Sleeve.....	794A
Strain Relievers.....	795









O-RINGS



26 Series Air Conditioning.....	748N
43 Series Flange.....	744
Caterpillar Style Flang.....	748I
ORFS.....	786
SAE Straight Thread Port.....	776A

QUICK COUPLERS (HYDRAULIC)

20 Series.....	791
60 Series.....	792
4000 Series.....	793
6100 Series.....	790
FEM Series.....	789
FF Series.....	794

HOSE THREAD FITTING GUIDES

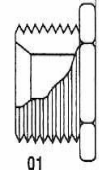
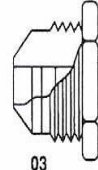
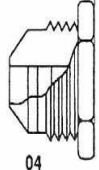
									
Fitting Size	DIN "L" Swivel Female Thread Size	DIN "S" Swivel Female Thread Size	DIN "L" Male Stud Thread Size	DIN "S" Male Stud Thread Size	Male BSPP Thread Size	BSP Swivel Female Thread Size	French Swivel Female Gaz Series	French Swivel Female Metric Series	French Male Stud Metric Series
4	—	—	—	—	1/4x19	1/4x19	—	—	—
6	M12x1.5	M14x1.5	M12x1.5	M14x1.5	3/8x19	3/8x19	—	—	M12x1
8	M14x1.5	M16x1.5	M14x1.5	M16x1.5	1/2x14	1/2x14	—	—	M14x1.5
10	M16x1.5	M18x1.5	M16x1.5	M18x1.5	5/8x14	5/8x14	—	—	M16x1.5
12	M18x1.5	M20x1.5	M18x1.5	M20x1.5	3/4x14	3/4x14	—	—	M18x1.5
—	—	—	—	—	—	—	M20x1.5	—	—
14	—	M22x1.5	—	M22x1.5	—	—	—	—	M20x1.5
15	M22x1.5	—	M22x1.5	—	—	—	—	—	M22x1.5
16	—	M24x1.5	—	M24x1.5	1x11	1x 11	—	—	M24x1.5
—	—	—	—	—	—	—	M24x1.5	—	—
18	M26x1.5	—	M26x1.5	—	—	—	—	—	M27x1.5
20	—	M30x2	—	M30x2	1 1/4x11	1 1/4x11	—	—	M27x1.5
—	—	—	—	—	—	—	M30x 1.5	—	—
22	M30x2	—	M30x2	—	—	—	—	—	M30x1.5
25	—	M36x2	—	M36x2	1 1/2x11	1 1/2x11	—	—	M33x1.5
—	—	—	—	—	—	—	M36x1.5	—	—
28	M36x2	—	M36x2	—	—	—	—	—	M36x1.5
30	—	M42x2	—	M42x2	2x11	2x11	—	—	M39x1.5
33	—	—	—	—	—	—	M45x1.5	—	—

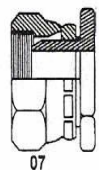
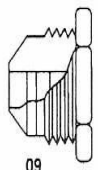
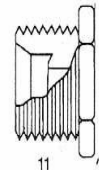
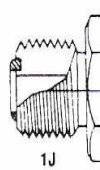
								
Dash Size	NPTF Pipe Thread Size	SAE (JIC) 37° Flare Thread Size	SAE 45° Flare Thread Size	"O" Ring Style Straight Thread Size	SAE Inverted Flare Thread Size	PTT 30° Flare Thread Size	SAE Flareless Thread Size	Seal-Lok Thread
2	1/8-27	5/16-24	5/16-24	5/16-24	—	—	5/16-24	—
3	—	3/8-24	3/8-24	3/8-24	—	—	3/8-24	—
4	1/4-18	7/16-20	7/16-20	7/16-20	1/4-18	—	7/16-20	9/16-18
5	—	1/2-20	1/2-20	1/2-20	—	—	1/2-20	—
6	3/8-18	9/16-18	5/8-18	9/16-18	3/8-18	—	9/16-18	11/16-16
8	1/2-14	3/4-16	3/4-16	3/4-16	1/2-14	—	3/4-16	13/16-16
10	—	7/8-14	7/8-14	7/8-14	—	—	7/8-14	1-14
12	3/4-14	11/16-12	11/16-12	11/16-12	—	—	11/16-12	13/16-12
14	—	13/16-12	—	13/16-12	—	—	13/16-12	—
16	1-11 1/2	15/16-12	—	15/16-12	—	15/16-14	15/16-12	17/16-12
20	1 1/4-11 1/2	15/8-12	—	15/8-12	—	15/8-14	15/8-12	—
24	1 1/2-11 1/2	17/8-12	—	17/8-12	—	17/8-14	17/8-12	—
32	2-11 1/2	2 1/2-12	—	2 1/2-12	—	2 1/2-12	2 1/2-12	—

HOSES / RUBBER

881/811 (SAE 100R4) LOW PRESSURE "Suction and Return Lines"

881/811 (SAE 100R4) HOSE CAN BE USED WITH THE FOLLOWING FITTINGS . . .

43 Series Pages 740 - 745

88 Series Page 764

Applications:

881 hose can be used for all hydraulic system hose suction or return lines.

Construction:

Synthetic rubber tube; reinforced by two textile braids or a woven ply, combined with wire spiraled throughout the textile reinforcement to prevent collapse under vacuum.



Hose Cover

need not be removed for assembly of no-skive fittings

Temperature Range:

-40°F to +257°F (-40°C to +125°C)

J&B #	HOSE I.D.	HOSE O.D.	PARKER #	MAXIMUM WORKING PRESSURE (PSI) 88HC-H Clamp	MAXIMUM WORKING PRESSURE (PSI) 88HC Clamp	MINIMUM BURST PRESSURE (PSI)	QTY
50812	3/4	1.20	811-12	300**	100*	1,200	Per/Ft
50816	1	1.49	811-16	250**	70*	1,000	Per/Ft
50817	1-1/4	1.78	811-20	200**	50*	800	Per/Ft
50819	1-1/2	2.06	881-24	150**	50*	600	Per/Ft
50821	2	2.48	881-32	100**	50*	400	Per/Ft

* Pressure is below 100R4 requirements.

** Parkrimp fitting pressure ratings.

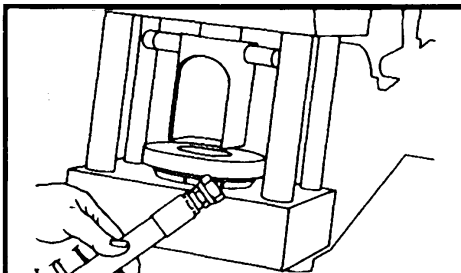

See brochure for crimp machine information. . .

HOSE / RUBBER

426 (SAE 100R1 AT) MEDIUM PRESSURE "Hi-Temp Hose"

426 (SAE 100R1 AT) HOSE CAN BE USED WITH THE FOLLOWING FITTINGS . . .

43 Series

Pages 740 - 745

Applications :

For air above 250 PSI (1,7 Mpa), the cover should be pin-pricked.

Construction:

Synthetic rubber tube; single high tensile steel wire braid reinforcement; MSHA accepted synthetic rubber cover.

Temperature Range:

Water, water/glycol, and water/oil emulsion hydraulic fluids up to +185°F (+85°C). Petroleum based hydraulic fluid and lubricating oils within a temperature range of -50°F to +302°F (-46°C to +150°C). Air within a temperature range of -40°F to + 158°F (-40°C to + 70°C).



Hose Cover

need not be removed for assembly of no-skive fittings

J&B #	HOSE I.D.	HOSE O.D.	PARKER #	MAXIMUM WORKING PRESSURE (PSI)	MINIMUM BURST PRESSURE (PSI)	QTY
50522	1/2	.81	426-8	2,000	8,000	Per/Ft

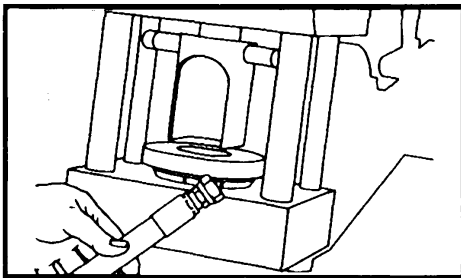

See brochure for crimp machine information. . .

HOSE / RUBBER

436 (SAE 100R1 AT) HIGH PRESSURE "Hi-Temp Hose"

436 (SAE 100R16) HOSE CAN BE USED WITH THE FOLLOWING FITTINGS . . .

43 Series

Pages 740 - 745

Applications :

For air above 250 PSI (1,7 Mpa), the cover should be pin-pricked. **Makes excellent pressure washer hose.**



Construction:

Synthetic rubber tube; single high tensile steel wire braid reinforcement; MSHA accepted synthetic rubber cover.

Hose Cover

need not be removed for assembly of no-skive fittings

Temperature Range:

Water, water/glycol, and water/oil emulsion hydraulic fluids up to +185°F (+85°C). Petroleum based hydraulic fluid and lubricating oils within a temperature range of -55°F to +302°F (-48°C to +150°C). Air within a temperature range of -40°F to + 158°F (-40°C to + 70°C).

J&B #	HOSE I.D.	HOSE O.D.	PARKER #	MAXIMUM WORKING PRESSURE (PSI)	MINIMUM BURST PRESSURE (PSI)	QTY
50520	3/8	.68	436-6	4,000	9,000	Per/Ft

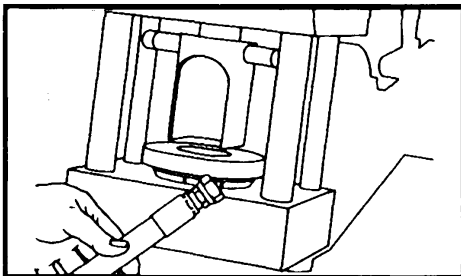

See brochure for crimp machine information. . .

HOSE / RUBBER

201 (SAE J1402 All) MEDIUM PRESSURE "Hi-Temp Hose"

201 (SAE J1402 All) HOSE CAN BE USED WITH THE FOLLOWING FITTINGS . . .

20 Series Pages 750 - 754

22 Series Page 757

26 Series Pages 748K-748N

****For Diesel Fuel or
Gasoline; Also consider
221FR hose (non-stock).

Applications:

Medium pressure hydraulic, turbo charger, filtration and lube oil lines, diesel fuel filter, engine and transmission coolant lines, ^air brake, power steering, and tilt cab. SAE J1402 and D.O.T. FMVSS 106-All air brake hose requirements.



Hose Cover

need not be removed for
assembly of no-skive fittings

Construction:

Synthetic rubber tube, textile inner braid, high tensile steel wire braid reinforcement, textile braid cover.

Temperature Range:

-40°F to +302°F (-40°C to +150°C) ^+158°F

maximum. * Usage at temperatures exceeding +200°F is based on reduced working pressure.

J&B #	PARKER #	HOSE INNER DIAMETER	HOSE O.D.	MAXIMUM WORKING PRESSURE (PSI)	MINIMUM BURST PRESSURE (PSI)	QTY
		READ NOTE BELOW!!!				
50204	201-4	++ 3/16 ++	.52	2,500	10,000	Per/Ft
50205	201-5	++ 1/4 ++	.58	2,250	9,000	Per/Ft
50206	201-6	++ 5/16 ++	.68	2,000	9,000	Per/Ft
50208	201-8	++ 13/32 ++	.77	1,850	8,000	Per/Ft
50210	201-10	++ 1/2 ++	.92	1,400	5,600	Per/Ft
50212	201-12	++ 5/8 ++	1.08	1,200	4,800	Per/Ft
50216	201-16	++ 7/8 ++	1.23	600	2,400	Per/Ft

++ When choosing Parker fittings to go with this hose, be sure to match Parker **DASH** numbers and **NOT** Hose I.D.

HOSE / RUBBER

SS25UL "LPG Hose"

SS25UL LPG HOSE CAN BE USED WITH THE FOLLOWING FITTINGS . . .

20 Series Pages 750 - 754

22 Series Page 757

26 Series Pages 748K-748P

Applications:

Designed for use with liquefied petroleum gas (LPG). Good for **Propane**.

Construction:

Synthetic rubber high temperature tube, one stainless steel wire braid and two textile braids.



Temperature Range:

-40°F to +257°F (-40°C to +125°C).

J&B #	HOSE I.D.	HOSE O.D.	PARKER #	MAXIMUM WORKING PRESSURE (PSI)	MINIMUM BURST PRESSURE (PSI)	QTY
++50106	5/16	.68	SS25UL-6	350	1,750	Per/Ft

++ This hose must be used with -6 fittings.

HOSE / RUBBER

302/301 (SAE 100R2 TYPE AT) HIGH PRESSURE

302/301 (SAE 100R2 TYPE AT) HOSE CAN BE USED WITH THE FOLLOWING FITTINGS . .

30 Series Pages 760 - 761

43 Series Pages 740 - 745

Applications:

High pressure service with petroleum base hydraulic fluids, *water glycol and *water-oil emulsion hydraulic fluids, hot oil, grease, lubricants, crude and fuel oils, ^air, *water. For air or gas applications above 250 psi the cover should be pin pricked. MSHA accepted cover.

Construction:

Synthetic rubber tube, two braids of high tensile steel wire reinforcement separated by synthetic rubber layer. Oil, weather and abrasion resistant synthetic rubber outer cover.



Hose Cover

need not be removed for assembly of no-skive fittings

Temperature Range:

-40°F to +212°F. (-40°C to +100°C) ^+158°F (+70°C) maximum, *+185°F (+85°C) maximum.

J&B #	HOSE I.D.	HOSE O.D.	PARKER #	MAXIMUM WORKING PRESSURE (PSI)	MINIMUM BURST PRESSURE (PSI)	QTY
50554	1/4	.59	302-4	5,800	20,000	Per/Ft
50556	3/8	.75	302-6	4,750	16,000	Per/Ft
50558	1/2	.88	302-8	4,000	14,000	Per/Ft
	5/8	1.00	302-10	3,600	11,000	Per/Ft
50562	3/4	1.16	302-12	3,100	9,000	Per/Ft
50564	1	1.50	302-16	2,400	8,000	Per/Ft
	1-1/4	1.86	302-20	1,800	6,500	Per/Ft
	1-1/2	2.16	302-24	1,300	5,000	Per/Ft
	2	2.66	302-32	1,150	4,500	Per/Ft

- Works outdoor better than 387TC. Use for trucks & outdoor equipment.
- Ok for diesel, but NOT for gasoline.

HOSE / RUBBER

487TC 4000 PSI CONSTANT PRESSURE TOUGH COVER HOSE

487TC HOSE CAN BE USED WITH THE FOLLOWING FITTINGS . .

43 Series

Pages 740-745

Applications:

Petroleum-based hydraulic fluids and lubrication oils.

Construction:

Inner tube of oil resistant Nitrile Synthetic rubber, One or two braids of high tensile steel wire reinforcement (four for -16) and an oil, weather and abrasion resistant, black, synthetic rubber, MSHA accepted cover.

Temperature Range:

Petroleum base hydraulic fluids and lubricating oils within a temperature range of -40 C to +100 C (-40 F to +212 F). Water, water/glycol, and water/oil emulsion hydraulic fluids up to +85 C (+185 F). Air up to 70 C (158 F).



Hose Cover

need not be removed for assembly of no-skive fittings

***** 487TC THROUGH -12 USES THE SILVER DIE RING
-16 USES THE BLACK DIE RING**

J&B #	HOSE I.D.	HOSE O.D.	MIN. BEND RADIUS	PARKER #	MAXIMUM WORKING PRESSURE (PSI)	MINIMUM BURST PRESSURE (PSI)	QTY
50584	1/4	.52	2	487TC-4	4000	16,000	Per/Ft
50585	3/8	.68	2-1/2	487TC-6	4000	16,000	Per/Ft
50588	1/2	.81	3-1/2	487TC-8	4000	16,000	Per/Ft
50589	5/8	.94	4	487TC-10	4000	16,000	Per/Ft
50591	3/4	1.10	4-3/4	487TC-12	4000	16,000	Per/Ft
50592	1	1.49	6	487TC-16	4000	16,000	Per/Ft

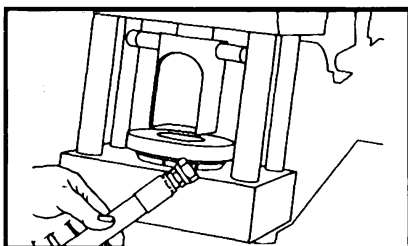

See brochure for crimp machine information. . .

HOSE / RUBBER

387TC 3000 PSI CONSTANT PRESSURE TOUGH COVER HOSE

387TC HOSE CAN BE USED WITH THE FOLLOWING FITTINGS . .

43 Series

Pages 740 - 745

Applications:

3000 PSI hose for applications where greater protection against abrasion is required.

Construction:

Synthetic rubber tube compatible with most petroleum-base hydraulic fluids; a high-tensile steel wire reinforcement; and an oil, weather, and abrasion resistant black synthetic rubber cover.

Temperature Range:

Most petroleum – base hydraulic and lubricating oils within a temperature range of -40°F to +212°F (40°C to +100°C). Water, water/glycol, and water/oil emulsion hydraulic fluids up to +185°F (+85°C). Air within a temperature range of -40°F to +158°F (-40°C to +70°C).



Hose Cover

need not be removed for assembly of no-skive fittings

***** 387TC THROUGH -16 USES THE SILVER DIE RING
-20 USES THE BLACK DIE RING**

J&B #	HOSE I.D.	HOSE O.D.	MIN. BEND RADIUS	PARKER #	MAXIMUM WORKING PRESSURE (PSI)	MINIMUM BURST PRESSURE (PSI)	QTY
50057	1/4	.53	2	387TC-4	3,000	12,000	Per/Ft
50059	3/8	.69	2-1/2	387TC-6	3,000	12,000	Per/Ft
50050	1/2	.82	3-1/2	387TC-8	3,000	12,000	Per/Ft
50051	5/8	.94	4	387TC-10	3,000	12,000	Per/Ft
50052	3/4	1.10	4-3/4	387TC-12	3,000	12,000	Per/Ft
50054	1	1.40	6	387TC-16	3,000	12,000	Per/Ft
50590	1-1/4	1.82	8-1/4	387TC-20	3,000	12,000	Per/Ft

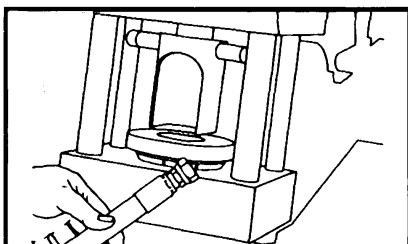

See brochure for crimp machine information. . .

HOSE / RUBBER

471TC (EN857 TYPE 25C) HIGH PRESSURE HYDRAULIC HOSE

471TC HOSE CAN BE USED WITH THE FOLLOWING FITTINGS . .

43 Series

Pages 740-745

**** ISO 11237-1 TYPE 2SC / EN857 TYPE 2SC**

Applications:

Petroleum-based hydraulic fluids and lubrication oils.

Construction:

Inner tube of oil resistant Nitrile Synthetic rubber, Multiple high tensile steel wire reinforcements; and an oil, weather and abrasion-resistant black MSHA-accepted synthetic rubber cover.

Temperature Range:

Petroleum base hydraulic fluids and lubricating oils within a temperature range of -40 C to +100 C (-40 F to +212 F). Water, water/glycol, and water/oil emulsion hydraulic fluids up to +85 C (+185 F). Air up to 70 C (158 F).



Hose Cover

need not be removed for assembly of no-skive fittings

J&B #	HOSE I.D.	HOSE O.D.	MIN. BEND RADIUS	PARKER #	MAXIMUM WORKING PRESSURE (PSI)	MINIMUM BURST PRESSURE (PSI)	QTY
50576	3/8	.68	2-1/2	471TC-6	5,000	20,000	Per/Ft
50578	1/2	.80	3-1/2	471TC-8	4,250	17,000	Per/Ft
50582	3/4	1.09	4-3/4	471TC-12	3,125	12,500	Per/Ft
50583	1	1.39	6	471TC-16	2,500	10,000	Per/Ft

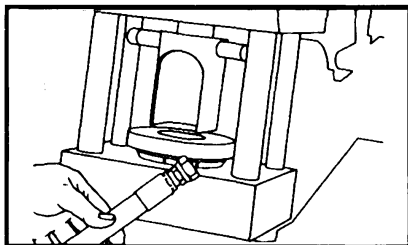

See brochure for crimp machine information. . .

HOSE / RUBBER

772TC (SAE 100R12) HIGH PRESSURE HYDRAULIC HOSE

772TC HOSE CAN BE USED WITH THE FOLLOWING FITTINGS . .

71 Series

Pages 748-748B

Applications:

Four heavy spiral hose for use on high pressure hydraulics.

Construction:

Inner tube of oil resistant Nitrile Synthetic rubber, 4 spiral piles of high tensile steel wire reinforcement; and an oil, weather, and abrasion resistant black synthetic MSHA accepted rubber cover.

Temperature Range:

Petroleum base hydraulic fluids and lubricating oils within a temperature range of -40 C to +125 C (-40 F to +257 F). Water, water/glycol, and water/oil emulsion hydraulic fluids up to +85 C (+185 F). Air up to 70 C (158 F).



Hose Cover

need not be removed for assembly of no-skive fittings

**HOSES MADE WITH
PARKRIMP 2**

J&B #	HOSE I.D.	HOSE O.D.	MIN. BEND RADIUS	PARKER #	MAXIMUM WORKING PRESSURE (PSI)	MINIMUM BURST PRESSURE (PSI)	QTY
55712	3/4	1.20	9-1/2	772TC-12	4,000	16,000	Per/Ft
55720	1-1/4	1.84	16-1/2	772TC-20	3,000	12,000	Per/Ft
55724	1-1/2	2.07	20	772TC-24	2,500	10,000	Per/Ft

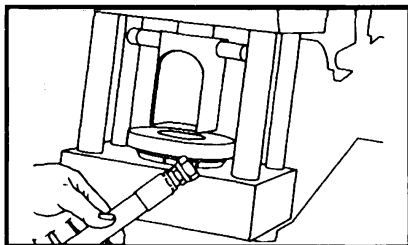

See brochure for crimp machine information. . .

HOSE / THERMOPLASTIC

518C MEDIUM PRESSURE

"Non-Conductive Hose"

518C HOSE CAN BE USED WITH THE FOLLOWING FITTINGS . . .

55 Series

Pages 746-747

Applications:

Hydraulic circuits and systems. Excellent low temperature flexibility and flex fatigue life, broad range of chemical compatibility, low elongation and volumetric expansion. Can be installed with very low bend radii. For hydraulic circuits and systems found on utility vehicles and equipment where exposure and contact with high voltage may be encountered.



Meets SAEJ343 for less than 50 microamps leakage under 75000 volts per ft. Meets or exceeds SAE 100R7 specifications.

Construction:

Elastomeric core, fiber reinforcement, abrasion-resistant special PFX cover. All layers bonded for optimum kink resistance and flexibility. High density braid for maximum impulse life without loss of flexibility. Standard cover is orange, non-perforated.

Temperature Range:

-40°F to +212°F (-40°C to +100°C) except limited to +135°F (+57°C) for synthetic hydraulic fluids and water-based fluids.

J&B #	HOSE I.D.	MAX O.D.	PARKER #	MAXIMUM WORKING PRESSURE (PSI)	MINIMUM BURST PRESSURE (PSI)	QTY
V50038	1/8	.34	518C-2	3,000	10,000	Per/Ft
50039	3/16	.42	518C-3	3,000	12,000	Per/Ft
50040	1/4	.47	518C-4	3,000	10,000	Per/Ft
50042	5/16	.57	518C-5	3,000	10,000	Per/Ft
50046	3/8	.63	518C-6	3,000	9,000	Per/Ft
50048	1/2	.81	518C-8	3,000	9,000	Per/Ft

NOTE: The above hose is not intended for use in static discharge applications; i.e., airless paint spray.

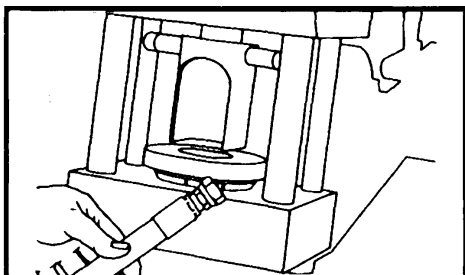

See brochure for crimp machine information. . .

HOSE / THERMOPLASTIC

518C MEDIUM PRESSURE

"Non-Conductive Hose"

518C HOSE CAN BE USED WITH THE FOLLOWING FITTINGS . . .

55 Series

Pages 746-747

Applications:

Hydraulic circuits and systems. Excellent low temperature flexibility and flex fatigue life, broad range of chemical compatibility, low elongation and volumetric expansion. Can be installed with very low bend radii. For hydraulic circuits and systems found on utility vehicles and equipment where exposure and contact with high voltage may be encountered.



Meets SAEJ343 for less than 50 microamps leakage under 75000 volts per ft. Meets or exceeds SAE 100R7 specifications.

Construction:

Elastomeric core, fiber reinforcement, abrasion-resistant special PFX cover. All layers bonded for optimum kink resistance and flexibility. High density braid for maximum impulse life without loss of flexibility. Standard cover is orange, non-perforated.

Temperature Range:

-40°F to +212°F (-40°C to +100°C) except limited to +135°F (+57°C) for synthetic hydraulic fluids and water-based fluids.

J&B #	HOSE I.D.	MAX O.D.	PARKER #	MAXIMUM WORKING PRESSURE (PSI)	MINIMUM BURST PRESSURE (PSI)	QTY
V50038	1/8	.34	518C-2	3,000	10,000	Per/Ft
50039	3/16	.42	518C-3	3,000	12,000	Per/Ft
50040	1/4	.47	518C-4	3,000	10,000	Per/Ft
50042	5/16	.57	518C-5	3,000	10,000	Per/Ft
50046	3/8	.63	518C-6	3,000	9,000	Per/Ft
50048	1/2	.81	518C-8	3,000	9,000	Per/Ft

NOTE: The above hose is not intended for use in static discharge applications; i.e., airless paint spray.

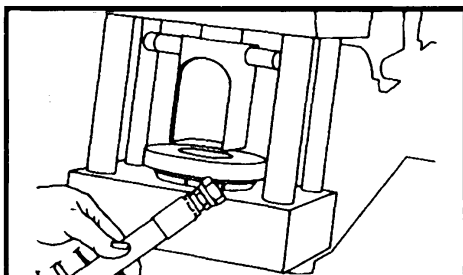

See brochure for crimp machine information. . .

HOSE / THERMOPLASTIC

919 (SAE100R14) MEDIUM PRESSURE "TFE Stainless"

919 (SAE100R14) HOSE CAN BE USED WITH THE FOLLOWING FITTINGS . . .

90 Series Page 767

91 Series Page 768

Applications:

TFE liner is inert to almost all chemicals. Outstanding flex fatigue and shock resistance for hydraulic systems. Smooth, low friction, non-stick inner surface and corrosion resistant wire. PTFE is flexible at low temperatures, non-aging and low moisture permeation. Can be used for steam up to 200 psi (+388°F).



Hose Cover

need not be removed for assembly of no-skive fittings

Construction:

Extruded PTFE core tube, 304 stainless steel wire braid for reinforcement and mechanical protection.

Temperature Range:

-100°F to +450°F (-73°C to +232°C).

J&B #	PARKER #	HOSE INNER DIAMETER	MAXIMUM WORKING PRESSURE (PSI)	MINIMUM BURST PRESSURE (PSI)	MIN. BEND RADIUS	QTY
		READ NOTE BELOW!!!!				
50307	919-4	++ 3/16 ++	3,000	12,000	2	Per/Ft
50305	919-5	++ 1/4 ++	3,000	12,000	3	Per/Ft
50308	919-6	++ 5/16 ++	2,500	10,000	4	Per/Ft
50309	919-8	++ 13/32 ++	2,000	8,000	5	Per/Ft
50310	919-10	++ 1/2 ++	1,500	6,000	6-1/2	Per/Ft
50312	919-12	++ 5/8 ++	1,200	5,000	7-1/2	Per/Ft

++ When choosing Parker fittings to go with this hose, be sure to match Parker **DASH** numbers and **NOT** Hose I.D.

AIR CONDITONING HOSE

285 (SAE J2064 TYPE C, CLASS 1) REFRIGERANT HOSE

285 HOSE CAN BE USED WITH THE FOLLOWING FITTINGS . .

26 Series

Pages

748K-748N

Construction:

The hose has a nylon barrier between two elastomeric layers, a fabric braid reinforcement and a heat, moisture and ozone resistant elastomer cover.

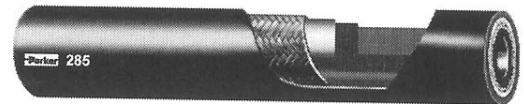

Temperature Range:

Refrigerant 12, 134a and 22 within a temperature range of -22 F to +257 F (-30 C to +125 C).

Hose Cover

need not be removed for assembly of no-skive fittings

285 HOSE IS ON OUR SHELF 50 FEET PER BOX

J&B #	HOS E I.D.	HOSE O.D.	MIN. BEND RADIUS	PARKER #	MAXIMUM WORKING PRESSURE (PSI)	MINIMUM BURST PRESSURE (PSI)	QTY
46032	5/16	0.62	1-1/2	285-6-BX	500	2,500	Per/Ft
46033	13/32	0.74	2	285-8-BX	500	2,500	Per/Ft
46034	1/2	0.83	2-1/2	285-10-BX	500	2,500	Per/Ft
46035	5/8	0.96	3	285-12-BX	500	2,500	Per/Ft

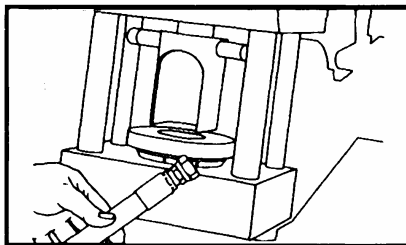

See brochure for crimp machine information. . .

PARKRIMP HOSE FITTINGS

43 SERIES

43 SERIES FITTINGS CAN BE USED WITH THE FOLLOWING HOSES

881/811 (SAE 100R4)	LOW PRESSURE HOSE	Page	720
426HT (SAE 100R1 AT)	MEDIUM PRESSURE HOSE	Page	724
302 (SAE 100R2 AT)	HIGH PRESSURE HOSE	Page	730
487TC (SAE 100R9 AT)	HIGH PRESSURE HOSE	Page	731
387TC	HIGH PRESSURE HOSE	Page	732
471TC	HIGH PRESSURE HOSE	Page	733

J&B #	PARKER #	HOSE I.D.	PIPE THREAD	QTY
52698	10143-2-4	1/4	1/8	1
52700	10143-4-4	1/4	1/4	1
52701	10143-6-4	1/4	3/8	1
52702	10143-4-6	3/8	1/4	1
52703	10143-6-6	3/8	3/8	1
52704	10143-8-6	3/8	1/2	1
52705	10143-6-8	1/2	3/8	1
52706	10143-8-8	1/2	1/2	1
52707	10143-12-8	1/2	3/4	1
57500	10143-6-10	5/8	3/8	1
52713	10143-8-10	5/8	1/2	1
52711	10143-12-10	5/8	3/4	1
52715	10143-8-12	3/4	1/2	1
52708	10143-12-12	3/4	3/4	1
52718	10143-16-12	3/4	1	1
52709	10143-12-16	1	3/4	1
52710	10143-16-16	1	1	1
52712	10143-20-20	1-1/4	1-1/4	1
52719	10143-24-24	1-1/2	1-1/2	1
52728	10143-32-32	2	2	1

MALE PIPE NPTF
10143

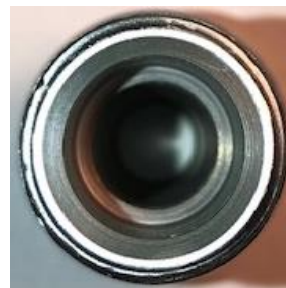
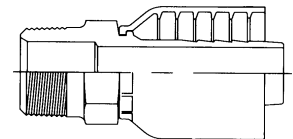

PARKRIMP HOSE FITTINGS

43 SERIES

J&B #	PARKER #	HOSE SIZE	MALE PIPE	QTY
56120	11L43-4-4	1/4	1/4	1
57501	11L43-6-4	1/4	3/8	1
55149	11L43-4-6	3/8	1/4	1
56121	11L43-6-6	3/8	3/8	1
57502	11L43-8-6	3/8	1/2	1
56122	11L43-8-8	1/2	1/2	1
56124	11L43-12-12	3/4	3/4	1

MALE NPTF PIPE 90° ELBOW SWIVEL

11L43

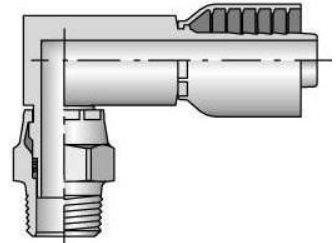

J&B #	PARKER #	HOSE SIZE	FEMALE PIPE	QTY
56417	10243-4-4	1/4	1/4	1
56419	10243-6-4	1/4	3/8	1
56420	10243-6-6	3/8	3/8	1
56421	10243-8-6	3/8	1/2	1
56422	10243-8-8	1/2	1/2	1
56424	10243-12-12	3/4	3/4	1

FEMALE NPTF PIPE - RIGID

10243

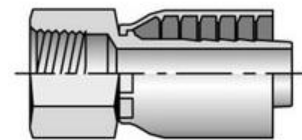

J&B #	PARKER #	HOSE SIZE	PIPE THREAD	QTY
55020	10743-4-4	1/4	1/4	1
55022	10743-6-6	3/8	3/8	1
55025	10743-8-8	1/2	1/2	1
55026	10743-12-12	3/4	3/4	1
55027	10743-16-16	1	1	1

FEMALE NPSM PIPE SWIVEL (60° CONE)

10743

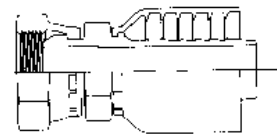

J&B #	PARKER #	HOSE I.D.	PIPE THREAD	QTY
56515	11343-2-4	1/4	1/8	1
54304	11343-4-4	1/4	1/4	1
57503	11343-6-4	1/4	3/8	1
54305	11343-4-6	3/8	1/4	1
54306	11343-6-6	3/8	3/8	1
54307	11343-8-6	3/8	1/2	1
54309	11343-6-8	1/2	3/8	1
54308	11343-8-8	1/2	1/2	1
54310	11343-12-12	3/4	3/4	1
54312	11343-16-16	1	1	1

MALE PIPE NPTF SWIVEL

11343

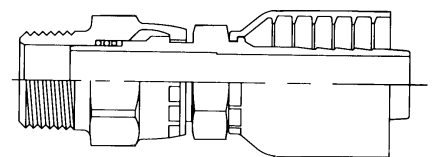

* The fitting allows minor movement under pressure to relieve stress on hose, but is not to be used for continuous or extensive swiveling.

PARKRIMP HOSE FITTINGS

43 SERIES

J&B #	PARKER #	HOSE I. D.	TUBE		QTY
			SIZE	THREAD	
* 52714	10643-4-4	1/4	1/4	7/16-20	1
* 52716	10643-5-4	1/4	5/16	1/2-20	1
52717	10643-6-4	1/4	3/8	9/16-18	1
52721	10643-4-6	3/8	1/4	7/16-20	1
52723	10643-5-6	3/8	5/16	1/2-20	1
52720	10643-6-6	3/8	3/8	9/16-18	1
* 52722	10643-8-6	3/8	1/2	3/4-16	1
55970	10643-10-6	3/8	5/8	7/8-14	1
52725	10643-6-8	1/2	3/8	9/16-18	1
* 52724	10643-8-8	1/2	1/2	3/4-16	1
* 52726	10643-10-8	1/2	5/8	7/8-14	1
52730	10643-12-8	1/2	3/4	1-1/16-12	1
52727	10643-8-10	5/8	1/2	3/4-16	1
52731	10643-10-10	5/8	5/8	7/8-14	1
52729	10643-12-10	5/8	3/4	1-1/16-12	1
52733	10643-8-12	3/4	1/2	3/4-16	1
* 52732	10643-10-12	3/4	5/8	7/8-14	1
52734	10643-12-12	3/4	3/4	1-1/16-12	1
* 52736	10643-14-12	3/4	7/8	1-3/16-12	1
* 52738	10643-16-12	3/4	1	1-5/16-12	1
52735	10643-12-16	1	3/4	1-1/16-12	1
* 52740	10643-16-16	1	1	1-5/16-12	1
52737	10643-20-16	1	1-1/4	1-5/8-12	1
57504	10643-16-20	1-1/4	1	1-5/16-12	1
* 52742	10643-20-20	1-1/4	1-1/4	1-5/8-12	1
52743	10643-24-24	1-1/2	1-1/2	1-7/8-12	1

JIC 37° SWIVEL 10643

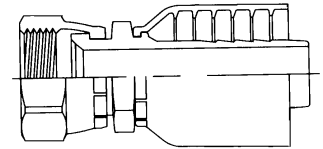

* Note: The 10643 couplings contain a dual seat that accepts both the JIC (37°) and SAE (45°) male configurations, except in sizes - 6 (3/8") and - 12 (3/4")

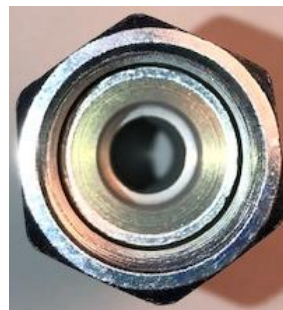

PARKRIMP HOSE FITTINGS

43 SERIES

J&B #	PARKER #	HOSE SIZE	TUBE		QTY
			SIZE	THREAD	
54244	10343-4-4	1/4	1/4	7/16-20	1
54242	10343-5-4	1/4	5/16	1/2-20	1
54245	10343-6-4	1/4	3/8	9/16-18	1
54247	10343-5-6	3/8	5/16	1/2-20	1
54249	10343-6-6	3/8	3/8	9/16-18	1
54250	10343-8-6	3/8	1/2	3/4-16	1
54252	10343-8-8	1/2	1/2	3/4-16	1
54253	10343-10-8	1/2	5/8	7/8-14	1
54263	10343-12-8	1/2	3/4	1-1/16-12	1
54251	10343-8-10	5/8	1/2	3/4-16	1
54254	10343-10-10	5/8	5/8	7/8-14	1
54255	10343-12-10	5/8	3/4	1-1/16-12	1
54256	10343-12-12	3/4	3/4	1-1/16-12	1
54258	10343-16-12	3/4	1	1-5/16-12	1
54259	10343-16-16	1	1	1-5/16-12	1
55930	10343-20-20	1-1/4	1-1/4	1-5/8-12	1

**MALE JIC 37°
10343**

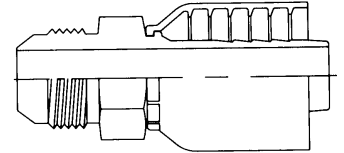

J&B #	PARKER #	HOSE SIZE	TUBE		QTY
			SIZE	THREAD	
54202	13743-4-4	1/4	1/4	7/16-20	1
57505	13743-5-4	1/4	5/16	1/2-20	1
54204	13743-6-4	1/4	3/8	9/16-18	1
54206	13743-6-6	3/8	3/8	9/16-18	1
54205	13743-8-6	3/8	1/2	3/4-16	1
54208	13743-8-8	1/2	1/2	3/4-16	1
54207	13743-10-8	1/2	5/8	7/8-14	1
54209	13743-10-10	5/8	5/8	7/8-14	1
54215	13743-12-10	5/8	3/4	1-1/16-12	1
54212	13743-12-12	3/4	3/4	1-1/16-12	1
54214	13743-16-16	1	1	1-5/16-12	1
55932	13743-20-20	1-1/4	1-1/4	1-5/8-12	1

**JIC 37° SWIVEL 45°
ELBOW
13743**

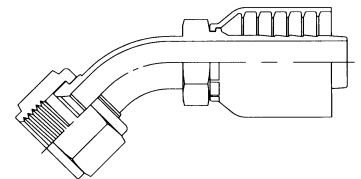

PARKRIMP HOSE FITTINGS

43 SERIES

J&B #	PARKER #	HOSE SIZE	TUBE		QTY
			SIZE	THREAD	
54219	13943-4-4	1/4	1/4	7/16-20	1
54225	13943-5-4	1/4	5/16	1/2-20	1
54222	13943-6-4	1/4	3/8	9/16-18	1
54295	13943-4-6	3/8	1/4	7/16-20	1
54223	13943-6-6	3/8	3/8	9/16-18	1
54224	13943-8-6	3/8	1/2	3/4-16	1
54296	13943-6-8	1/2	3/8	9/16-16	1
54226	13943-8-8	1/2	1/2	3/4-16	1
54227	13943-10-8	1/2	5/8	7/8-14	1
57506	13943-12-8	1/2	3/4	1-1/16-12	1
54228	13943-10-10	5/8	5/8	7/8-14	1
54298	13943-12-10	5/8	3/4	1-1/16-12	1
54230	13943-12-12	3/4	3/4	1-1/16-12	1
54231	13943-16-12	3/4	1	1-5/16-12	1
54232	13943-16-16	1	1	1-5/16-12	1
55934	13943-20-20	1-1/4	1-1/4	1-5/8-12	1

**JIC 37° SWIVEL 90°
ELBOW (Short)**

13943

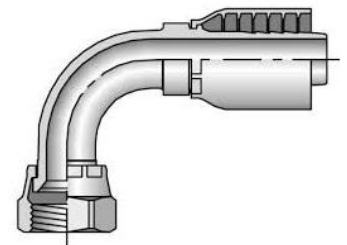

J&B #	PARKER #	HOSE SIZE	TUBE		QTY
			SIZE	THREAD	
57507	1L943-4-4	1/4	1/4	7/16-20	1
57508	1L943-6-6	3/8	3/8	9/16-20	1
57509	1L943-8-8	1/2	1/2	3/4-16	1
57510	1L943-12-12	3/4	3/4	1-1/16-12	1
57511	1L943-16-16	1	1	1-5/16-12	1

**JIC 37° SWIVEL 90°
ELBOW (Medium)**

1L943

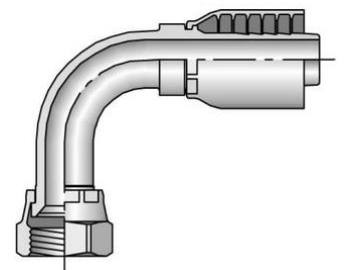

J&B #	PARKER #	HOSE I. D.	TUBE		QTY
			SIZE	THREAD	
56140	14143-4-4	1/4	1/4	7/16-20	1
56141	14143-5-4	1/4	5/16	1/2-20	1
56142	14143-6-6	3/8	3/8	9/16-18	1
56144	14143-8-8	1/2	1/2	3/4-16	1
56145	14143-10-10	5/8	5/8	7/8-14	1
56146	14143-12-12	3/4	3/4	1-1/16-12	1
56147	14143-16-16	1	1	1-5/16-12	1
56148	14143-20-20	1-1/4	1-1/4	1-5/8-12	1

**JIC 37° SWIVEL 90°
ELBOW (LONG)**

14143

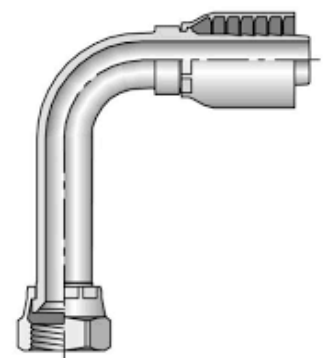

PARKRIMP HOSE FITTINGS

43 SERIES

J&B #	PARKER #	HOSE SIZE	SEAL LOK		QTY
			SIZE	THREAD	
56290	1JS43-4-4	1/4	1/4	9/16-18	1
56292	1JS43-6-4	1/4	3/8	11/16-16	1
56293	1JS43-4-6	3/8	1/4	9/16-18	1
56294	1JS43-6-6	3/8	3/8	11/16-16	1
56295	1JS43-8-6	3/8	1/2	13/16-16	1
56296	1JS43-6-8	1/2	3/8	11/16-16	1
56300	1JS43-8-8	1/2	1/2	13/16-16	1
56301	1JS43-10-8	1/2	5/8	1-14	1
56299	1JS43-12-8	1/2	3/4	1-3/16-12	1
56297	1JS43-8-10	5/8	1/2	13/16-16	1
56302	1JS43-10-10	5/8	5/8	1-14	1
56304	1JS43-12-10	5/8	3/4	1-3/16-12	1
56306	1JS43-10-12	3/4	5/8	1-14	1
56307	1JS43-12-12	3/4	3/4	1-3/16-12	1
56308	1JS43-16-12	3/4	1	1-7/16-12	1
56311	1JS43-12-16	1	3/4	1-3/16-12	1
56309	1JS43-16-16	1	1	1-7/16-12	1
56310	1JS43-20-20	1-1/4	1-1/4	1-11/16-12	1

**FLAT FACE
FEMALE "SEAL LOK"
SWIVEL STRAIGHT**

1JS43

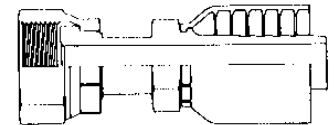

J&B #	PARKER #	HOSE SIZE	SEAL LOK		QTY
			SIZE	THREAD	
56510	1JC43-4-4	1/4	1/4	9/16-18	1
57512	1JC43-6-4	1/4	3/8	11/16-16	1
57513	1JC43-4-6	3/8	1/4	9/16-18	1
56512	1JC43-6-6	3/8	3/8	11/16-16	1
57514	1JC43-8-6	3/8	1/2	13/16-16	1
56514	1JC43-8-8	1/2	1/2	13/16-16	1
57515	1JC43-10-8	1/2	5/8	1-14	1
57516	1JC43-12-8	1/2	3/4	1-3/16-12	1
56509	1JC43-10-10	5/8	5/8	1-14	1
57517	1JC43-12-12	3/4	3/4	1-3/16-12	1

**FLAT FACE
FEMALE "SEAL LOK"
SWIVEL STRAIGHT
(CLOSE NUT)**

1JC43

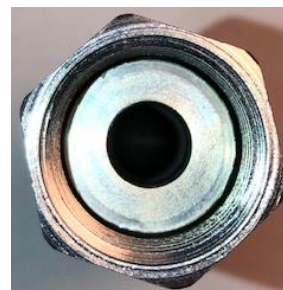
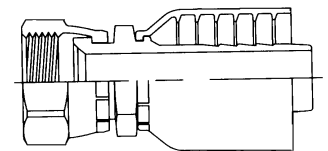

PARKRIMP HOSE FITTINGS

43 SERIES

J&B #	PARKER #	HOSE SIZE	SEAL LOK		QTY
			SIZE	THREAD	
56388	1J943-4-4	1/4	1/4	9/16-18	1
56389	1J943-6-4	1/4	3/8	11/16-16	1
56390	1J943-6-6	3/8	3/8	11/16-16	1
56392	1J943-8-6	3/8	1/2	13/16-16	1
56418	1J943-6-8	1/2	3/8	11/16-16	1
56400	1J943-8-8	1/2	1/2	13/16-16	1
56402	1J943-10-8	1/2	5/8	1-14	1
56404	1J943-12-8	1/2	3/4	1-3/16-12	1
56405	1J943-8-10	5/8	1/2	13/16-16	1
56406	1J943-10-10	5/8	5/8	1-14	1
56408	1J943-12-10	5/8	3/4	1-3/16-12	1
56409	1J943-10-12	3/4	5/8	1-14	1
56410	1J943-12-12	3/4	3/4	1-3/16-12	1
56412	1J943-16-12	3/4	1	1-7/16-12	1
56414	1J943-16-16	1	1	1-7/16-12	1
56415	1J943-20-20	1-1/4	1-1/4	1-11/16-12	1

**FLAT FACE
FEMALE "SEAL LOK"
SWIVEL 90° ELBOW
(SHORT)
1J943**

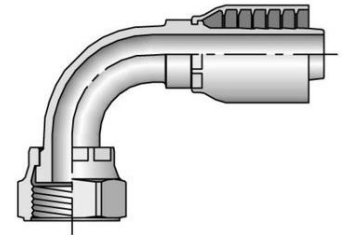

J&B #	PARKER #	HOSE SIZE	SEAL LOK		QTY
			SIZE	THREAD	
57518	1J543-4-4	1/4	1/4	9/16-18	1
57519	1J543-6-6	3/8	3/8	11/16-16	1
57520	1J543-8-6	3/8	1/2	13/16-16	1
57521	1J543-8-8	1/2	1/2	13/16-16	1
57522	1J543-10-10	5/8	5/8	1-14	1
57523	1J543-12-12	3/4	3/4	1-3/16-12	1

**FLAT FACE
FEMALE "SEAL LOK"
SWIVEL 90° ELBOW
MEDIUM DROP
1J543**

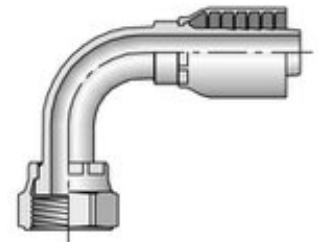

J&B #	PARKER #	HOSE SIZE	SEAL LOK		QTY
			SIZE	THREAD	
52560	1J143-4-4	1/4	1/4	9/16-18	1
52561	1J143-6-6	3/8	3/8	11/16-16	1
52562	1J143-8-8	1/2	1/2	13/16-12	1
57524	1J143-10-10	5/8	5/8	1-14	1
52564	1J143-12-12	3/4	3/4	1-3/16-12	1

**FLAT FACE
FEMALE "SEAL LOK"
SWIVEL 90° ELBOW
LONG DROP
1J143**

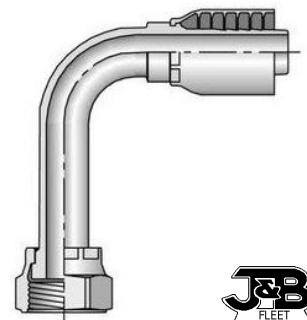

PARKRIMP HOSE FITTINGS

43 SERIES

J&B #	PARKER #	HOSE SIZE	SEAL LOK		QTY
			SIZE	THREAD	
55140	1J743-4-4	1/4	1/4	9/16-18	1
55142	1J743-6-4	1/4	3/8	11/16-16	1
55143	1J743-4-6	3/8	1/4	9/16-18	1
55144	1J743-6-6	3/8	3/8	11/16-16	1
55146	1J743-8-6	3/8	1/2	13/16-16	1
55147	1J743-6-8	1/2	3/8	11/16-16	1
55148	1J743-8-8	1/2	1/2	13/16-16	1
55150	1J743-10-8	1/2	5/8	1-14	1
55152	1J743-12-8	1/2	3/4	1-3/16-12	1
57525	1J743-8-10	5/8	1/2	13/16-16	1
55154	1J743-10-10	5/8	5/8	1-14	1
55156	1J743-12-12	3/4	3/4	1-3/16-12	1
55158	1J743-16-16	1	1	1-7/16-12	1
55160	1J743-20-20	1-1/4	1-1/4	1-11/16-12	1

**FLAT FACE
FEMALE "SEAL LOK"
SWIVEL 45 ELBOW**

1J743

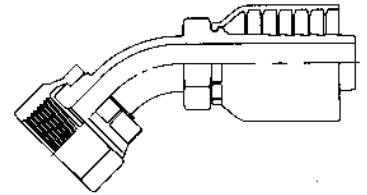

J&B #	PARKER #	HOSE SIZE	SEAL LOK		QTY
			SIZE	THREAD	
52820	1J043-4-4	1/4	1/4	9/16-18	1
52821	1J043-6-6	3/8	3/8	11/16-16	1
52822	1J043-8-6	3/8	1/2	13/16-16	1
52823	1J043-8-8	1/2	1/2	13/16-16	1
52825	1J043-10-8	1/2	5/8	1-14	1
52824	1J043-10-10	5/8	5/8	1-14	1
52826	1J043-12-10	5/8	3/4	1-3/16-12	1
52828	1J043-12-12	3/4	3/4	1-3/16-12	1
52830	1J043-16-12	3/4	1	1-7/16-12	1

**MALE "SEAL LOK"
STRAIGHT WITH
NITRILE O-RING**

1J043

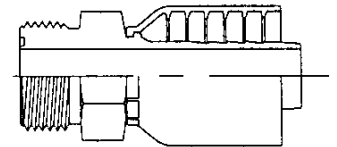

PARKRIMP HOSE FITTINGS

43 SERIES

J&B #	PARKER #	HOSE SIZE	THREAD SIZE	QTY
55000	10543-4-4	1/4	7/16-20	1
57526	10543-6-4	1/4	9/16-18	1
55003	10543-6-6	3/8	9/16-18	1
55004	10543-8-6	3/8	3/4-16	1
57527	10543-10-6	3/8	7/8-14	1
55005	10543-6-8	1/2	9/16-18	1
55006	10543-8-8	1/2	3/4-16	1
55009	10543-10-8	1/2	7/8-14	1
55010	10543-12-8	1/2	1-1/16-12	1
55011	10543-10-10	5/8	7/8-14	1
55012	10543-12-10	5/8	1-1/16-12	1
55014	10543-12-12	3/4	1-1/16-12	1
55016	10543-16-16	1	1-5/16-12	1

**MALE SAE
STRAIGHT THREAD
WITH O-RING - RIGID**

10543

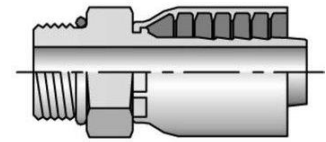

J&B #	PARKER #	HOSE SIZE	THREAD SIZE	QTY
56470	10L43-6-6	3/8	9/16-18	1
57528	10L43-8-6	3/8	3/4-16	1
56472	10L43-8-8	1/2	3/4-16	1
57554	10L43-10-8	1/2	7/8-14	1
57529	10L43-12-12	3/4	1-1/16-12	1

**MALE SAE
STRAIGHT THREAD
WITH O-RING
90° ELBOW SWIVEL**

10L43

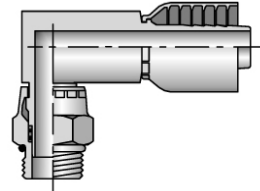

J&B #	PARKER #	HOSE SIZE	THREAD SIZE	QTY
57555	10G43-6-4	1/4	9/16-18	1
52696	10G43-6-6	3/8	9/16-18	1
57556	10G43-8-6	3/8	3/4-16	1
57530	10G43-8-8	1/2	3/4-16	1
57557	10G43-10-8	1/2	7/8-14	1
57531	10G43-12-12	3/4	1-1/16-12	1

**MALE SAE
STRAIGHT THREAD
WITH O-RING
SWIVEL**

10G43

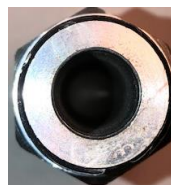
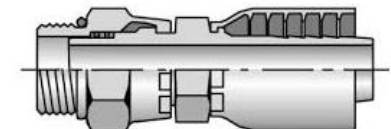

PARKRIMP HOSE FITTINGS

43 SERIES

**MALE INVERTED
SAE 45° - SWIVEL**

12843

J&B #	PARKER #	HOSE SIZE	THREAD	QTY
56339	12843-4-4	1/4	7/16-24	1
56440	12843-5-6	3/8	1/2-20	1

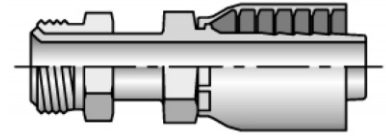

**MALE INVERTED
SAE 45° - SWIVEL
90° ELBOW**

16943

J&B #	PARKER #	HOSE SIZE	THREAD	QTY
56450	16943-5-6	3/8	1/2-20	1

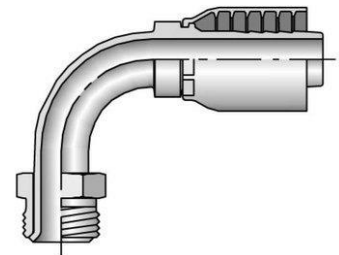

PARKRIMP HOSE FITTINGS

43 SERIES

J&B #	PARKER #	HOSE SIZE	TUBE		QTY
			SIZE	THREAD	
52744	10843-6-6	3/8	3/8	5/8-18	1
52747	10843-12-12	3/4	3/4	1-1/16-14	1

SAE 45° SWIVEL
10843

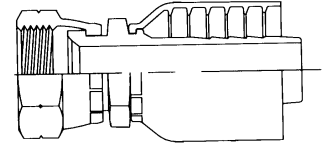

J&B #	PARKER #	HOSE SIZE	TUBE		QTY
			SIZE	THREAD	
57553	17943-6-6	3/8	3/8	5/8-18	1

SAE 45° SWIVEL
90° ELBOW
17943

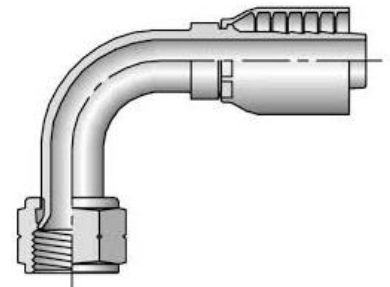

PARKRIMP HOSE FITTINGS

43 SERIES

SAE (Code 61)
FLANGE STRAIGHT

J&B #	PARKER #	HOSE SIZE	FLANGE SIZE	FLANGE O.D.	FLANGE HEIGHT	QTY
52749	11543-8-8	1/2	1/2	1-3/16	.265"	1
52754	11543-12-12	3/4	3/4	1-1/2	.265"	1
^ 52755	11543-16-12	3/4	1	1-3/4	.315"	1
52756	11543-16-16	1	1	1-3/4	.315"	1
^ 52753	11543-20-16	1	1-1/4	2"	.315"	1

11543

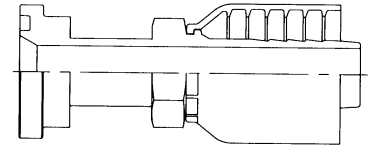

O-rings not included

SAE (Code 61)
FLANGE 90° ELB.

J&B #	PARKER #	HOSE SIZE	FLANGE SIZE	FLANGE O.D.	FLANGE HEIGHT	QTY
^ 52751	11943-8-8	1/2	1/2	1-3/16	.265"	1
^ 52757	11943-12-8	1/2	3/4	1-1/2	.265"	1
52758	11943-12-12	3/4	3/4	1-1/2	.265"	1
^ 52759	11943-16-12	3/4	1	1-3/4	.315"	1
52760	11943-16-16	1	1	1-3/4	.315"	1
^ 52761	11943-20-16	1	1-1/4	2	.315"	1

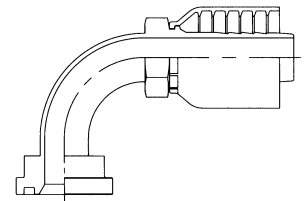

O-rings not included

90 DUROMETER NITRILE O-RINGS

J&B #	PARKER #	FLANGE DASH SIZE	FLANGE SIZE	WIDTH	I.D.	QTY
56278	711510-6	-8	1/2	.139	.734	1
56280	711510-5	-12	3/4	.139	.984	1
56282	711510-4	-16	1	.139	1.296	1
56284	711510-3	-20	1-1/4	.139	1.484	1
56286	711510-2	-24	1-1/2	.139	1.859	1
56288	711510-1	-32	2	.139	2.234	1

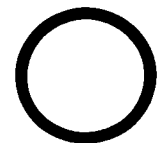

O-RING

* Numbers with a "^^" are not necessarily stocked in large quantities

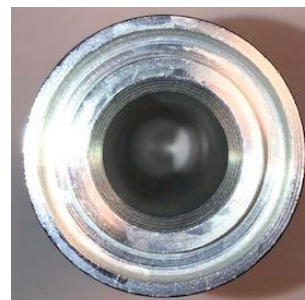
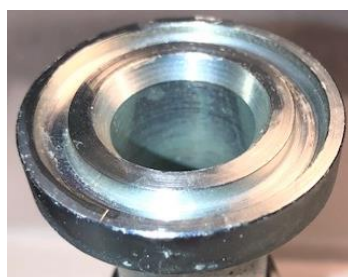

PARKRIMP HOSE FITTINGS

43 SERIES

J&B #	PARKER #	HOSE SIZE	BSPP PIPE THREAD	QTY
54234	1FU43-4-4	1/4	1/4-19	1
54236	1FU43-6-6	3/8	3/8-19	1
54237	1FU43-8-8	1/2	1/2-14	1
54238	1FU43-12-12	3/4	3/4-14	1

**BSP PARALLEL
PIPE (30° FLARE)
SWIVEL FEMALE**

1FU43

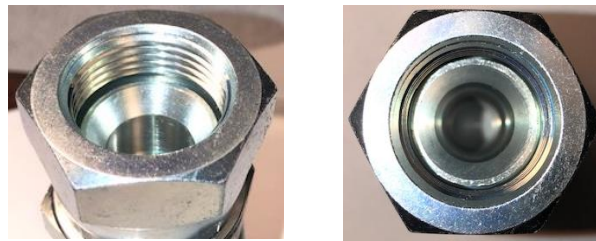
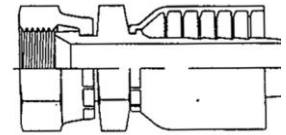

- FNMT4 Caps & PNMT4 Plugs mate with FU fittings.

J&B #	PARKER #	HOSE SIZE	TUBE		QTY
			SIZE	THREAD	
55120	1MU43-4-4	1/4	1/4	M14-1.5	1
55122	1MU43-6-6	3/8	3/8	M18-1.5	1
55124	1MU43-8-8	1/2	1/2	M22-1.5	1

**METRIC (30° FLARE)
SWIVEL FEMALE**

1MU43

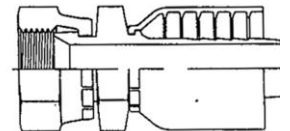

J&B #	PARKER #	HOSE SIZE	TUBE		QTY
			SIZE	THREAD	
55126	1XU43-10-10	5/8	5/8	M24-1.5	1

**METRIC (30° FLARE)
SWIVEL FEMALE**

1XU43

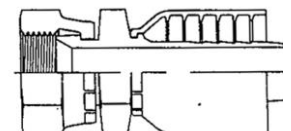

PARKRIMP HOSE FITTINGS

43 SERIES

J&B #	PARKER #	HOSE SIZE	BSP PIPE THREAD	QTY
55110	1GU43-4-4	1/4	1/4-19	1
55114	1GU43-6-6	3/8	3/8-19	1
55116	1GU43-8-8	1/2	1/2-14	1

**BSP PARALLEL PIPE
(60° CONE)
SWIVEL FEMALE
1GU43**

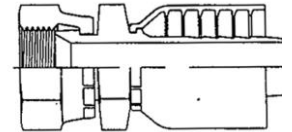
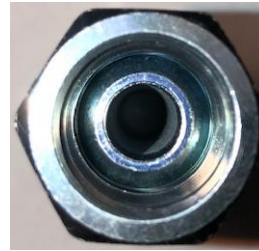

- Not the same as 19243 on page 744B. **Will not** mate with K4 BSP adapters.

J&B #	PARKER #	HOSE SIZE	BSP PIPE THREAD	QTY
55130	1UT43-4-4	1/4	1/4-19	1
55132	1UT43-6-6	3/8	3/8-19	1
55134	1UT43-8-8	1/2	1/2-14	1

**MALE JIS/BSP TAPER
(60° CONE)
1UT43**

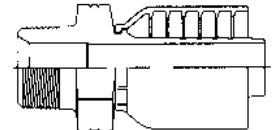

PARKRIMP HOSE FITTINGS

43 SERIES

J&B #	PARKER #	HOSE SIZE	BSPP PIPE THREAD	QTY
55030	19243-4-4	1/4	1/4-19	1
55032	19243-6-6	3/8	3/8-19	1
55034	19243-8-8	1/2	1/2-14	1
55036	19243-12-12	3/4	3/4-14	1
55038	19243-16-16	1	1-11	1

**BSPP SWIVEL
FEMALE
BALL NOSE
19243**

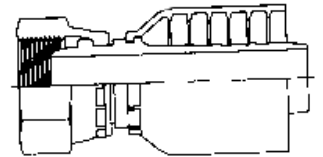

- Not the same as 1GU43 on page 744A. Will mate with K4 BSP adapters.

J&B #	PARKER #	HOSE SIZE	BSPP PIPE THREAD	QTY
55060	1B243-4-4	1/4	1/4-19	1
55062	1B243-6-6	3/8	3/8-19	1
55064	1B243-8-8	1/2	1/2-14	1
55066	1B243-12-12	3/4	3/4-14	1

**BSPP SWIVEL
FEMALE 90 ELBOW
BALL NOSE
1B243**

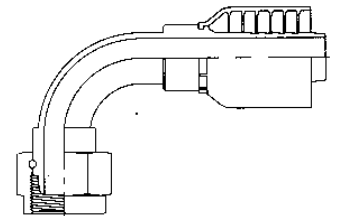

J&B #	PARKER #	HOSE SIZE	BSPP PIPE THREAD	QTY
55044	1B143-4-4	1/4	1/4-19	1
55046	1B143-6-6	3/8	3/8-19	1
55048	1B143-8-8	1/2	1/2-14	1

**BSPP SWIVEL
FEMALE 45 ELBOW
BALL NOSE
1B143**

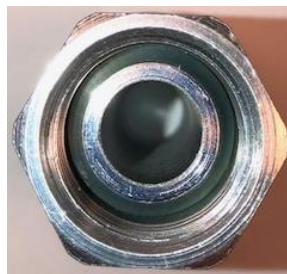
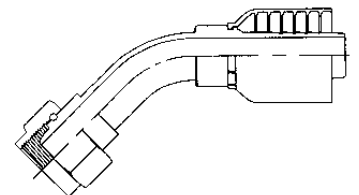

PARKRIMP HOSE FITTINGS

43 SERIES

J&B #	PARKER #	HOSE SIZE	TUBE		QTY
			SIZE	THREAD	
55070	1C343-6-4	1/4	6mm	M12-1.5	1
55072	1C343-8-4	1/4	8mm	M14-1.5	1
55074	1C343-10-6	3/8	10mm	M16-1.5	1
55076	1C343-12-6	3/8	12mm	M18-1.5	1
55078	1C343-15-8	1/2	15mm	M22-1.5	1
55080	1C343-18-10	5/8	18mm	M26-1.5	1
55082	1C343-22-12	3/4	22mm	M30-2.0	1

METRIC SWIVEL
FEMALE **BALL NOSE**
LIGHT SERIES

1C343

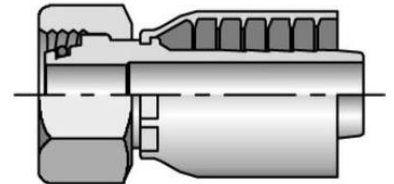

- Mates with **Parker EO (Ferulok)** fittings... Remove nut & Ferrule.

J&B #	PARKER #	HOSE SIZE	TUBE		QTY
			SIZE	THREAD	
55088	1C543-8-4	1/4	8mm	M14-1.5	1
55090	1C543-10-6	3/8	10mm	M16-1.5	1
55092	1C543-12-6	3/8	12mm	M18-1.5	1
55094	1C543-15-8	1/2	15mm	M22-1.5	1
55095	1C543-18-10	5/8	18mm	M26-1.5	1
55096	1C543-22-12	3/4	22mm	M30-2.0	1

METRIC SWIVEL
FEMALE **BALL NOSE**
LIGHT SERIES
90 ELBOW

1C543

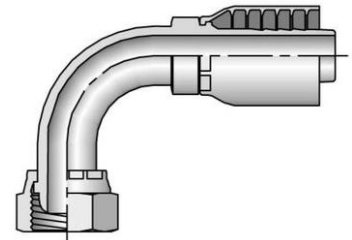

J&B #	PARKER #	HOSE SIZE	TUBE		QTY
			SIZE	THREAD	
57532	1C443-8-4	1/4	8mm	M14-1.5	1
57533	1C443-12-6	3/8	12mm	M18-1.5	1
57534	1C443-15-8	1/2	15mm	M22-1.5	1

METRIC SWIVEL
FEMALE **BALL NOSE**
LIGHT SERIES
45 ELBOW

1C443

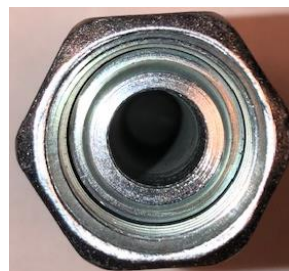
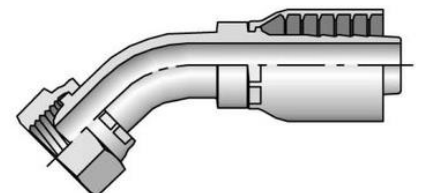

PARKRIMP HOSE FITTINGS

43 SERIES

METRIC SWIVEL
FEMALE 24° CONE
HEAVY SERIES
WITH O-RING

1C943

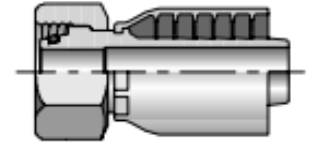

J&B #	PARKER #	HOSE SIZE	TUBE		QTY
			SIZE	THREAD	
55100	1C943-8-4	1/4	8mm	M16-1.5	1
55102	1C943-10-4	1/4	10mm	M18-1.5	1
55103	1C943-10-6	3/8	10mm	M18-1.5	1
55104	1C943-12-6	3/8	12mm	M20-1.5	1
55106	1C943-14-6	3/8	14mm	M22-1.5	1
55107	1C943-16-8	1/2	16mm	M24-1.5	1
57535	1C943-20-10	5/8	20mm	M30-2.0	1

- Mates with **Parker EO Heavy** fittings... Remove nut & Ferrule.

METRIC RIGID
MALE 24° CONE
HEAVY SERIES
WITH O-RING

1D243

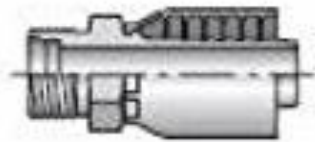

J&B #	PARKER #	HOSE SIZE	TUBE		QTY
			SIZE	THREAD	
57536	1D243-8-4	1/4	8mm	M16-1.5	1
55410	1D243-12-6	3/8	12mm	M20-1.5	1
57537	1D243-16-8	1/2	16mm	M24-1.5	1

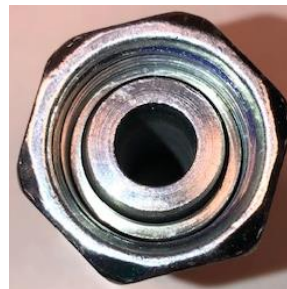

PARKRIMP HOSE FITTINGS

43 SERIES

J&B #	PARKER #	HOSE SIZE	TUBE		QTY
			SIZE	THREAD	
57538	11C43-8-4	1/4	8mm	M16-1.5	1
57539	11C43-12-6	3/8	12mm	M20-1.5	1
57540	11C43-16-8	1/2	16mm	M24-1.5	1

- Mates with **Parker EO Heavy** fittings... Remove nut & Ferrule.

METRIC SWIVEL
90° ELBOW
FEMALE 24° CONE
HEAVY SERIES
WITH O-RING

11C43

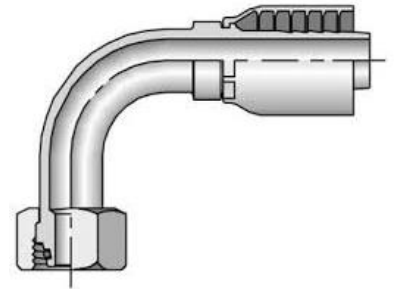

J&B #	PARKER #	HOSE SIZE	TUBE		QTY
			SIZE	THREAD	
57541	10C43-8-4	1/4	8mm	M16-1.5	1
57542	10C43-12-6	3/8	12mm	M20-1.5	1
57543	10C43-16-8	1/2	16mm	M24-1.5	1

METRIC SWIVEL
45° ELBOW
FEMALE 24° CONE
HEAVY SERIES
WITH O-RING

10C43

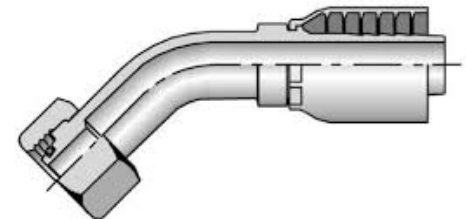

PARKRIMP HOSE FITTINGS

43 SERIES

J&B #	PARKER #	HOSE SIZE	TUBE		QTY
			SIZE	THREAD	
55437	1CA43-6-4	1/4	6mm	M12-1.5	1
55438	1CA43-8-4	1/4	8mm	M14-1.5	1
55440	1CA43-10-4	1/4	10mm	M16-1.5	1
57544	1CA43-10-5	5/16	10mm	M16-1.5	1
55442	1CA43-12-6	3/8	12mm	M18-1.5	1
55443	1CA43-15-8	1/2	15mm	M22-1.5	1
57545	1CA43-18-10	5/8	18mm	M26-1.5	1
55445	1CA43-18-12	3/4	18mm	M26-1.5	1

METRIC SWIVEL
FEMALE 24° CONE

LIGHT SERIES
WITH O-RING

1CA43

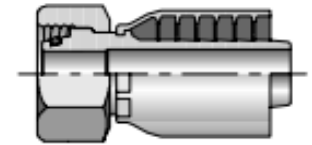

- Mates with **Parker EO Light** fittings... Remove nut & Ferrule.

J&B #	PARKER #	HOSE SIZE	TUBE		QTY
			SIZE	THREAD	
51266	1D043-8-4	1/4	8mm	M14-1.5	1
57546	1D043-10-5	5/16	10mm	M16-1.5	1
51267	1D043-10-6	3/8	10mm	M16-1.5	1
51268	1D043-12-6	3/8	12mm	M18-1.5	1
51269	1D043-15-8	1/2	15mm	M22-1.5	1
57547	1D043-18-10	5/8	18mm	M26-1.5	1

METRIC SWIVEL
MALE 24° CONE

LIGHT SERIES
WITH O-RING

1D043

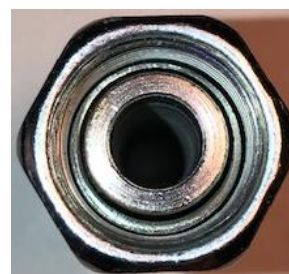
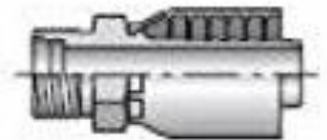

PARKRIMP HOSE FITTINGS

43 SERIES

J&B #	PARKER #	HOSE SIZE	TUBE		QTY
			SIZE	THREAD	
55446	1CF43-8-4	1/4	8mm	M14-1.5	1
57592	1CF43-10-6	3/8	10mm	M16-1.5	1
57548	1CF43-15-8	1/2	15mm	M22-1.5	1
57549	1CF43-18-10	5/8	18mm	M26-1.5	1

**METRIC SWIVEL
90° ELBOW
FEMALE 24° CONE
LIGHT SERIES
WITH O-RING
1CF43**

- Mates with **Parker EO Light** fittings... Remove nut & Ferrule.

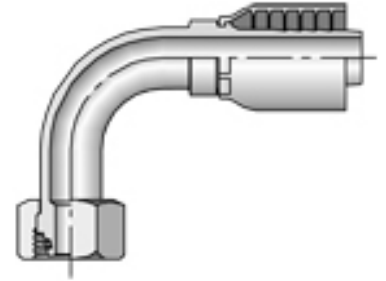

J&B #	PARKER #	HOSE SIZE	TUBE		QTY
			SIZE	THREAD	
57550	1CE43-8-4	1/4	8mm	M14-1.5	1
57594	1CE43-10-6	3/8	10mm	M16-1.5	1
57551	1CE43-15-8	1/2	15mm	M22-1.5	1
57552	1CE43-18-10	5/8	18mm	M26-1.5	1

**METRIC SWIVEL
45° ELBOW
FEMALE 24° CONE
LIGHT SERIES
WITH O-RING
1CE43**

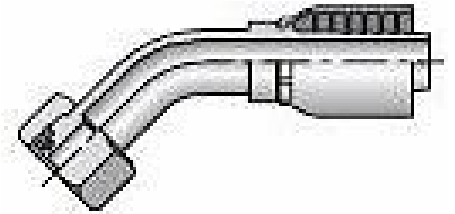

PARKRIMP HOSE FITTINGS

78 SERIES

J&B #	PARKER #	HOSE SIZE	FLANGE SIZE	FLANGE O.D.	FLANGE HEIGHT	QTY
55395	1XA78-16-16	1	1	1-7/8	.560"	1
55397	1XA78-20-20	1-1/4	1-1/4	2-1/8	.560"	1
55399	1XA78-24-24	1-1/2	1-1/2	2-1/2	.560"	1

CATERPILLAR STYLE
FLANGE STRAIGHT

1XA78

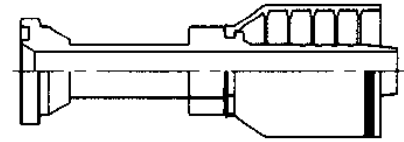

O-rings not included... they are located on page 748I

J&B #	PARKER #	HOSE SIZE	FLANGE SIZE	FLANGE O.D.	FLANGE HEIGHT	QTY
55415	1XN78-16-16	1	1	1-7/8	.560"	1
55417	1XN78-20-16	1	1-1/4	2-1/8	.560"	1
55419	1XN78-20-20	1-1/4	1-1/4	2-1/8	.560"	1
55421	1XN78-24-24	1-1/2	1-1/2	2-1/2	.560"	1

CATERPILLAR STYLE
FLANGE 90° ELBOW

1XN78

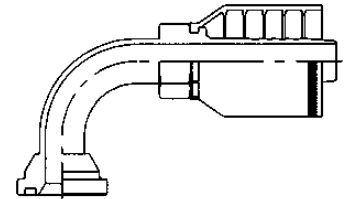

O-rings not included... they are located on page 748I

J&B #	PARKER #	HOSE SIZE	FLANGE SIZE	FLANGE O.D.	FLANGE HEIGHT	QTY
55402	1XF78-16-16	1	1	1-7/8	.560"	1
55403	1XF78-20-16	1	1-1/4	2-1/8	.560"	1
55405	1XF78-20-20	1-1/4	1-1/4	2-1/8	.560"	1
55407	1XF78-24-24	1-1/2	1-1/2	2-1/2	.560"	1

CATERPILLAR STYLE
FLANGE 45° ELBOW

1XF78

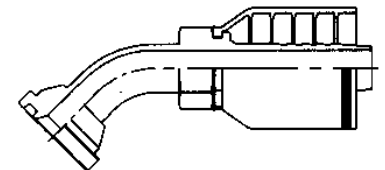

O-rings not included... they are located on page 748I

PARKRIMP HOSE FITTINGS

78 SERIES

J&B #	PARKER #	HOSE SIZE	FLANGE SIZE	FLANGE O.D.	FLANGE HEIGHT	QTY
55434	1XE78-20-20	1-1/4	1-1/4	2-1/8	.560"	1

CATERPILLAR STYLE
FLANGE 30° ELBOW

1XE78

O-rings not included... they are located below.

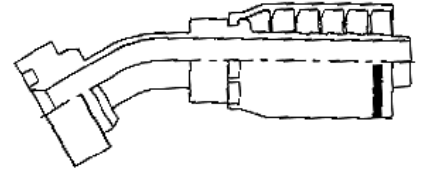

J&B #	PARKER #	HOSE SIZE	FLANGE SIZE	FLANGE O.D.	FLANGE HEIGHT	QTY
55428	1XG78-20-20	1-1/4	1-1/4	2-1/8	.560"	1

CATERPILLAR STYLE
FLANGE 60° ELBOW

1XG78

O-rings not included... they are located below.

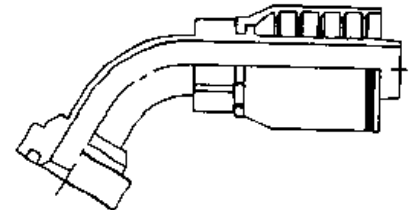

FLANGE "D" RING CATERPILLAR STYLE FLANGES

J&B #	FLANGE SIZE	PARKER #	DASH SIZE	I.D.	O.D.	QTY
55361	1	XARG-16	-16	0.20	1.25	1
55362	1-1/4	XARG-20	-20	0.20	1.50	1
55363	1-1/2	XARG-24	-24	0.20	1.75	1

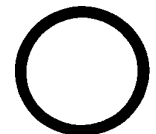

O-RING

PARKRIMP HOSE FITTINGS

43 SERIES "FERRUL-FIX"

Fast, On-The-Job Repair For Ruptured Bent Tube Hose Assemblies And Power Steering Lines

Problem . . .

The life of the combination tube-hose assembly is often limited to the service life of the hose alone. A replacement assembly may not be available, since equipment dealers are unable to stock all of the many odd tube configurations.

Solution . . .

Parker FERRUL-FIX, a field attachable, reusable hose end fitting, now makes it possible to salvage the bent tube section of the original assembly for replacement. Most important, it gets you back into operation FAST!

GETS YOU BACK IN OPERATION FAST - No costly delays while replacement assemblies are rushed from the factory.

LETS YOU REUSE EXPENSIVE BENT TUBE ENDS - You can replace the hose at a fraction of the cost of complete assembly.

ELIMINATES NEED FOR EMERGENCY BRAZING OR WELDING IN THE FIELD - Ferrul-Fix can be assembled without special tools or equipment.

Result . . .

Features . . .

3-Piece Design - body, nut, ferrule. Wedging action of ferrule, when drawn down by nut, forms seal between body and ferrule, while cutting edge of ferrule "bites" into tube wall forming another positive seal.

Visible Bite - Extent of bite at cutting edge of ferrule is completely visible when fitting is dis-assembled; an important safety feature. Self-centering action assures even bite around circumference of tube.

Parkerize Finish - Ferrul-Lok fittings have the Parkerize black finish, providing "built-in" lubrication which reduces wrench torque in make-up.

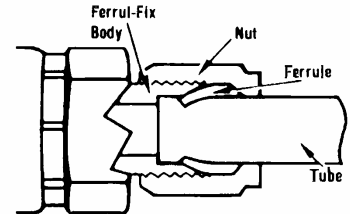

J&B #	PARKER #	HOSE I.D.	TUBE		QTY
			SIZE	THREAD	
^ 52745	11143-4-4	1/4	1/4	7/16-20	1
^ 52840	11143-5-4	1/4	5/16	1/2-20	1
^ 52842	11143-4-6	3/8	1/4	7/16-20	1
^ 52844	11143-5-6	3/8	5/16	1/2-20	1
52746	11143-6-6	3/8	3/8	9/16-18	1
52748	11143-8-8	1/2	1/2	3/4-16	1
52750	11143-10-8	1/2	5/8	7/8-14	1
52752	11143-12-12	3/4	3/4	1-1/16-12	1
^ 52789	11143-16-16	1	1	1-5/16-12	1

(SAE Flareless)
"Ferrul-Fix"

11143

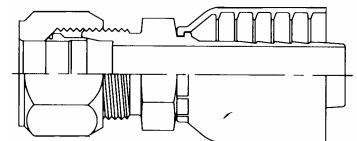

* Numbers with a "A" are not necessarily stocked in large quantities

FERRUL-FIX INSTALLATION INSTRUCTIONS:

1. Cut the formed tube off squarely next to the permanent hose fitting. Lightly deburr the end of the tube internally and externally.
2. Disassemble the Ferrul-Fix fitting, and lubricate threads and both ends of the ferrule with an extreme pressure lubricant. Slide nut and ferrule onto tubing, with the long, straight end of the ferrule pointing toward the tube end.
3. Insert tube end into the Ferrul-Fix body until it bottoms against the shoulder. Slide ferrule inside body, and screw nut down finger tight.
4. Tighten nut with a wrench until tube no longer can be rotated easily. From this point, tighten nut one more complete turn. Disconnect nut and inspect lead edge of ferrule to make certain that the biting edge has turned up a shoulder completely around the tube.
5. Assemble Ferrul-Fix fitting to hose. Refer to assembly instructions listed in appropriate fittings section.
6. Reassemble tubing into Ferrul-Fix end and turn nut finger tight. Turn bent tube to proper position if required. Using two wrenches, one on the fitting nipple hex and the other on the nut, tighten nut from 1/6 to 1/3 turn.

PARKRIMP HOSE FITTINGS

STAINLESS STEEL 43 SERIES

J&B #	PARKER #	HOSE I. D.	TUBE		QTY
			SIZE	THREAD	
* V53080	10643-4-4C	1/4	1/4	7/16-20	1
V53081	10643-6-6C	3/8	3/8	9/16-18	1
* V53082	10643-8-8C	1/2	1/2	3/4-16	1
V53084	10643-12-12C	3/4	3/4	1-1/16-12	1
* V53085	10643-16-16C	1	1	1-5/16-12	1
* V53086	10643-20-20C	1-1/4	1-1/4	1-5/8-12	1

JIC 37° SWIVEL 10643

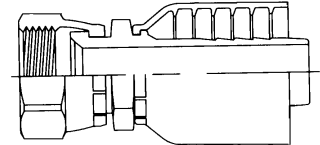

- * Note: The 10643 couplings contain a dual seat that accepts both the JIC (37°) and SAE (45°) male configurations, except in sizes - 6 (3/8") and - 12 (3/4")

PARFLEX HOSE FITTINGS

55 SERIES

55 SERIES FITTINGS CAN BE USED WITH THE FOLLOWING HOSE

558H or 518C (SAE100R7) NON-CONDUCTIVE MEDIUM PRESSURE HOSE -
Page 734

J&B #	PARKER #	HOSE I. D.	PIPE THREAD	QTY
54017	10155-2-3	3/16	1/8	1
54018	10155-2-4	1/4	1/8	1
54020	10155-4-4	1/4	1/4	1
54021	10155-4-5	5/16	1/4	1
54022	10155-4-6	3/8	1/4	1
54023	10155-6-5	5/16	3/8	1
54025	10155-6-6	3/8	3/8	1
54028	10155-6-8	1/2	3/8	1
54029	10155-8-8	1/2	1/2	1

MALE PIPE

10155

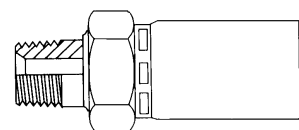

J&B #	PARKER #	HOSE I. D.	TUBE		QTY
			SIZE	THREAD	
54037	10655-3-3	3/16	3/16	3/8-24	1
**54038	**10657-4-2	1/8	1/4	7/16-20	1
54039	10655-4-3	3/16	1/4	7/16-20	1
54040	10655-4-4	1/4	1/4	7/16-20	1
54042	10655-6-4	1/4	3/8	9/16-18	1
54043	10655-5-5	5/16	5/16	1/2-20	1
54044	10655-6-5	5/16	3/8	9/16-18	1
54045	10655-6-6	3/8	3/8	9/16-18	1
54046	10655-8-6	3/8	1/2	3/4-16	1
54047	10655-8-8	1/2	1/2	3/4-16	1
54048	10655-10-8	1/2	5/8	7/8-14	1

JIC 37° SWIVEL

10655

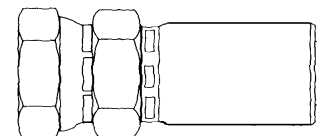

** 57 Series fittings for use on 518C hose only.

J&B #	PARKER #	HOSE I. D.	TUBE		QTY
			SIZE	THREAD	
54059	10355-4-3	3/16	1/4	7/16-20	1
54060	10355-4-4	1/4	1/4	7/16-20	1
54062	10355-5-5	5/16	5/16	1/2-20	1
54063	10355-6-4	1/4	3/8	9/16-18	1
54064	10355-6-5	5/16	3/8	9/16-18	1
54066	10355-6-6	3/8	3/8	9/16-18	1
54067	10355-8-6	3/8	1/2	3/4-16	1
54068	10355-8-8	1/2	1/2	3/4-16	1

MALE JIC 37°

10355

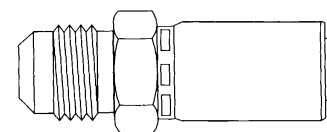

PARFLEX HOSE FITTINGS

55 SERIES

J&B #	PARKER #	HOSE I. D.	TUBE		QTY
			SIZE	THREAD	
56508	13755-4-4	1/4	1/4	7/16-20	1
56704	13755-6-5	5/16	3/8	9/16-18	1
56705	13755-6-6	3/8	3/8	9/16-18	1

**JIC 37° SWIVEL 45°
ELBOW
13755**

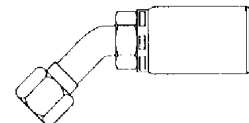

J&B #	PARKER #	HOSE I. D.	TUBE		QTY
			SIZE	THREAD	
56502	1L955-4-4	1/4	1/4	7/16-20	1

**(JIC) 37° SWIVEL
90° LONG ELBOW
14155**

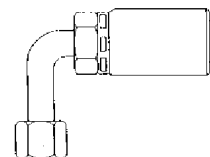

J&B #	PARKER #	HOSE I. D.	TUBE		QTY
			SIZE	THREAD	
56494	13955-4-3	3/16	1/4	7/16-20	1
56495	13955-4-4	1/4	1/4	7/16-20	1
*56497	13955-6-4	1/4	3/8	9/16-18	1
*56500	13955-6-6	3/8	3/8	9/16-18	1
56498	13955-8-6	3/8	1/2	3/4-16	1
56501	13955-8-8	1/2	1/2	3/4-16	1

**FEMALE SAE (JIC) 37°
SWIVEL 90° ELBOW
13955**

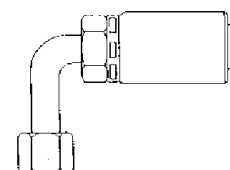

J&B #	PARKER #	HOSE I. D.	TUBE		QTY
			SIZE	THREAD	
*56600	14155-6-5	5/16	3/8	9/16-18	1

**SAE (JIC) 37° SWIVEL
90° ELBOW SPECIAL
1L955**

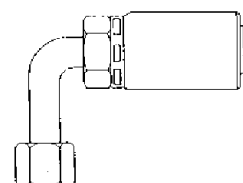

* JIC only (not SAE)

PARFLEX HOSE FITTINGS

55 SERIES

J&B #	PARKER #	HOSE I. D.	SEAL LOK		QTY
			SIZE	THREAD	
54074	1JC55-6-6	3/8	3/8	11/16-16	1
54075	1JC56-8-6	3/8	1/2	13/16-16	1
54076	1JC56-8-8	1/2	1/2	13/16-16	1

**FLAT FACE
FEMALE
"SEAL LOK"
SWIVEL STRAIGHT
1JC55**

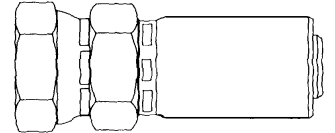

J&B #	PARKER #	HOSE I. D.	PIPE THREAD	QTY
54009	11355-8-8	1/2	1/2	1

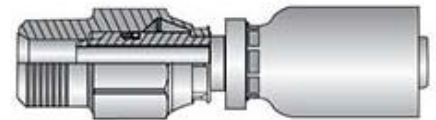

**MALE PIPE
SWIVEL
11355**

PARKRIMP HOSE FITTINGS

71 SERIES

71 SERIES FITTINGS CAN BE USED WITH THE FOLLOWING HOSES

772TC (SAE 100R12)

HIGH PRESSURE HOSE -

Page 733B

J&B #	PARKER #	HOSE I. D.	TUBE		QTY
			SIZE	THREAD	
55186	10671-16-12	3/4	1	1-5/16-12	1
55194	10671-24-24	1-1/2	1-1/2	1-7/8-12	1
55196	10671-32-32	2	2	2-1/2-12	1

**JIC 37° SWIVEL
10671**

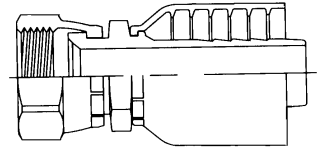

J&B #	PARKER #	HOSE I.D.	PIPE THREAD	QTY
55172	10171-16-16	1	1	1
55178	10171-32-32	2	2	1

**MALE PIPE NPTF
10171**

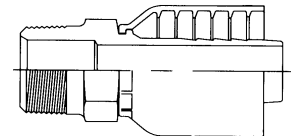

PARKRIMP HOSE FITTINGS

71 SERIES

J&B #	PARKER #	HOSE SIZE	FLANGE SIZE	FLANGE O.D.	FLANGE HEIGHT	QTY
55202	11571-16-12	3/4	1	1-3/4	.315"	1
55206	11571-20-16	1	1-1/4	2	.315"	1
55208	11571-20-20	1-1/4	1-1/4	2	.315"	1
55212	11571-24-24	1-1/2	1-1/2	2-3/8	.315"	1
55214	11571-32-32	2	2	2-13/16	.375"	1

SAE (Code 61)
FLANGE STRAIGHT

11571

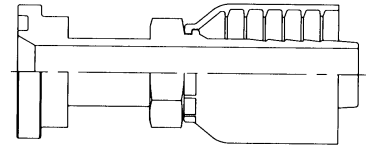

O-rings not included

J&B #	PARKER #	HOSE SIZE	FLANGE SIZE	FLANGE O.D.	FLANGE HEIGHT	QTY
55236	11971-12-12	3/4	3/4	1-1/2	.265"	1
55240	11971-20-16	1	1-1/4	2	.315"	1
55242	11971-20-20	1-1/4	1-1/4	2	.315"	1
55244	11971-24-20	1-1/4	1-1/2	2-3/8	.315"	1
55246	11971-24-24	1-1/2	1-1/2	2-3/8	.315"	1
55248	11971-32-32	2	2	2-13/16	.375"	1

SAE (Code 61)
FLANGE 90° ELB.

11971

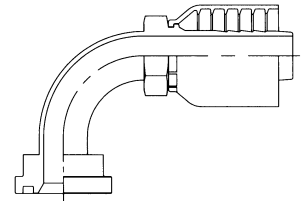

O-rings not included

J&B #	PARKER #	HOSE SIZE	FLANGE SIZE	FLANGE O.D.	FLANGE HEIGHT	QTY
55218	11771-12-12	3/4	3/4	1-1/2	.265"	1
55220	11771-16-12	3/4	1	1-3/4	.315"	1
55222	11771-16-16	1	1	1-3/4	.315"	1
55224	11771-20-16	1	1-1/4	2	.315"	1
55226	11771-20-20	1-1/4	1-1/4	2	.315"	1
55228	11771-24-20	1-1/4	1-1/2	2-3/8	.315"	1
55230	11771-24-24	1-1/2	1-1/2	2-3/8	.315"	1
55232	11771-32-32	2	2	2-13/16	.375"	1

SAE (Code 61)
FLANGE 45° ELB.

11771

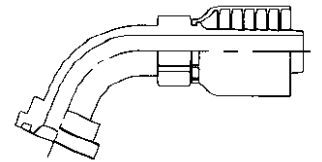

O-rings not included

PARKRIMP HOSE FITTINGS

71 SERIES

J&B #	PARKER #	HOSE SIZE	FLANGE SIZE	FLANGE O.D.	FLANGE HEIGHT	QTY
55254	16A71-12-12	3/4	3/4	1-5/8	.345"	1
55256	16A71-16-16	1	1	1-7/8	.375"	1
55258	16A71-20-16	1	1-1/4	2-1/8	.405"	1
55260	16A71-20-20	1-1/4	1-1/4	2-1/8	.405"	1
55262	16A71-24-24	1-1/2	1-1/2	2-1/2	.495"	1
55264	16A71-32-32	2	2	3-1/8	.495"	1

O-rings not included

SAE (Code 62)
FLANGE STRAIGHT

16A71

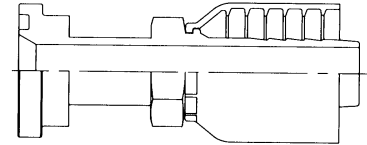

J&B #	PARKER #	HOSE SIZE	FLANGE SIZE	FLANGE O.D.	FLANGE HEIGHT	QTY
55270	16F71-12-12	3/4	3/4	1-5/8	.345"	1
55272	16F71-16-16	1	1	1-7/8	.375"	1
55274	16F71-20-20	1-1/4	1-1/4	2-1/8	.405"	1
55276	16F71-24-24	1-1/2	1-1/2	2-1/2	.495"	1
55278	16F71-32-32	2	2	3-1/8	.495"	1

O-rings not included

SAE (Code 62)
FLANGE 45° ELB.

16F71

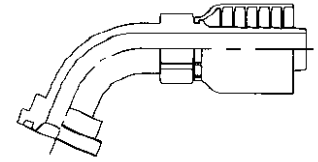

J&B #	PARKER #	HOSE SIZE	FLANGE SIZE	FLANGE O.D.	FLANGE HEIGHT	QTY
55282	16N71-16-12	3/4	1	1-7/8	.375"	1
55286	16N71-20-16	1	1-1/4	2-1/8	.405"	1
55288	16N71-20-20	1-1/4	1-1/4	2-1/8	.405"	1
55290	16N71-24-24	1-1/2	1-1/2	2-1/2	.495"	1
55292	16N71-32-32	2	2	3-1/8	.495"	1

O-rings not included

SAE (Code 62)
FLANGE 90° ELB.

16N71

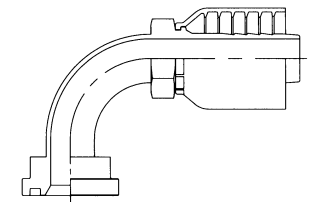

PARKRIMP HOSE FITTINGS

71 SERIES

J&B #	PARKER #	HOSE SIZE	SEAL LOK		QTY
			SIZE	THREAD	
55684	1JS71-20-20	1-1/4	1-1/4	1-11/16-12	1

FEMALE "SEAL LOK"
SWIVEL STRAIGHT

1JS71

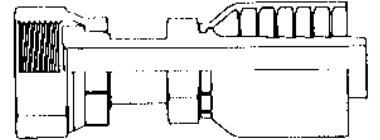

J&B #	PARKER #	HOSE SIZE	SEAL LOK		QTY
			SIZE	THREAD	
55694	1J971-20-20	1-1/4	1-1/4	1-11/16-12	1

FEMALE "SEAL LOK"
SWIVEL 90° ELBOW
(SHORT)

1J971

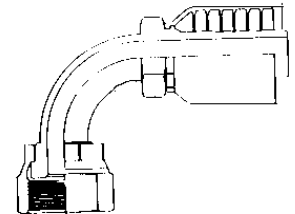

J&B #	PARKER #	HOSE SIZE	SEAL LOK		QTY
			SIZE	THREAD	
55687	1J771-12-12	3/4	3/4	1-3/16-12	1
55688	1J771-16-16	1	1	1-7/16-12	1
55689	1J771-20-20	1-1/4	1-1/4	1-11/16-12	1

FEMALE "SEAL LOK"
SWIVEL 45 ELBOW

1J771

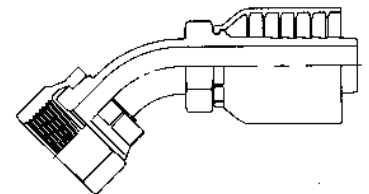

PARKRIMP HOSE FITTINGS

78 SERIES

78 SERIES FITTINGS CAN BE USED WITH THE FOLLOWING HOSES

78C (SAE 100R13)

HIGH PRESSURE HOSE -

Page 733C

J&B #	PARKER #	HOSE I. D.	TUBE		QTY
			SIZE	THREAD	
55312	10678-20-20	1-1/4	1-1/4	1-5/8-12	1
55314	10678-24-24	1-1/2	1-1/2	1-7/8-12	1

**FEMALE JIC 37°
SWIVEL
10678**

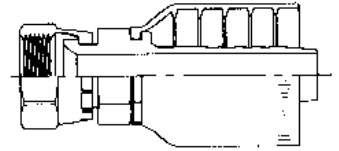

J&B #	PARKER #	HOSE I.D.	PIPE THREAD	QTY
55300	10178-16-16	1	1	1
55302	10178-20-20	1-1/4	1-1/4	1
55304	10178-24-24	1-1/2	1-1/2	1

**MALE PIPE NPTF
10178**

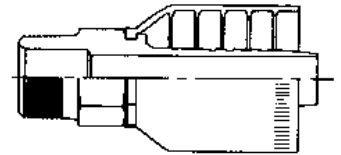

PARKRIMP HOSE FITTINGS

78 SERIES

J&B #	PARKER #	HOSE SIZE	FLANGE SIZE	FLANGE O.D.	FLANGE HEIGHT	QTY
55320	14A78-20-20	1-1/4	1-1/4	2	.315"	1
55322	14A78-24-24	1-1/2	1-1/2	2-3/8	.315"	1

SAE (Code 61)
FLANGE STRAIGHT

14A78

O-rings not included

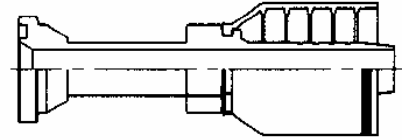

J&B #	PARKER #	HOSE SIZE	FLANGE SIZE	FLANGE O.D.	FLANGE HEIGHT	QTY
55340	14N78-20-20	1-1/4	1-1/4	2	.315"	1
55342	14N78-24-24	1-1/2	1-1/2	2-3/8	.315"	1

SAE (Code 61)
FLANGE 90° ELB.

14N78

O-rings not included

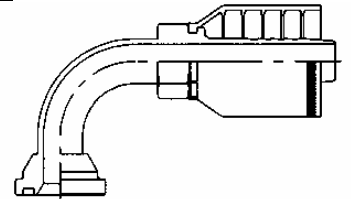

J&B #	PARKER #	HOSE SIZE	FLANGE SIZE	FLANGE O.D.	FLANGE HEIGHT	QTY
55330	14F78-20-20	1-1/4	1-1/4	2	.315"	1
55332	14F78-24-24	1-1/2	1-1/2	2-3/8	.315"	1

SAE (Code 61)
FLANGE 45° ELB.

14F78

O-rings not included

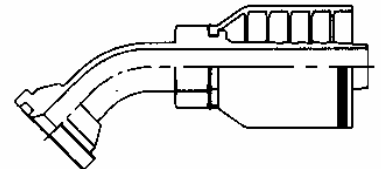

PARKRIMP HOSE FITTINGS

78 SERIES

J&B #	PARKER #	HOSE SIZE	FLANGE SIZE	FLANGE O.D.	FLANGE HEIGHT	QTY
55352	16A78-20-16	1	1-1/4	2-1/8	.405"	1
55354	16A78-20-20	1-1/4	1-1/4	2-1/8	.405"	1
55356	16A78-24-20	1-1/4	1-1/2	2-1/2	.495"	1
55358	16A78-24-24	1-1/2	1-1/2	2-1/2	.495"	1

SAE (Code 62)
FLANGE STRAIGHT

16A78

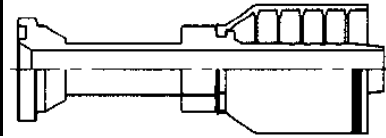

O-rings not included

J&B #	PARKER #	HOSE SIZE	FLANGE SIZE	FLANGE O.D.	FLANGE HEIGHT	QTY
55382	16N78-20-16	1	1-1/4	2-1/8	.405"	1
55384	16N78-20-20	1-1/4	1-1/4	2-1/8	.405"	1
55386	16N78-24-20	1-1/4	1-1/2	2-1/2	.495"	1
55388	16N78-24-24	1-1/2	1-1/2	2-1/2	.495"	1

SAE (Code 62)
FLANGE 90° ELB.

16N78

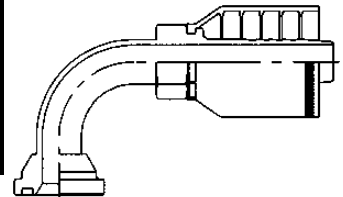

O-rings not included

J&B #	PARKER #	HOSE SIZE	FLANGE SIZE	FLANGE O.D.	FLANGE HEIGHT	QTY
55367	16F78-20-16	1	1-1/4	2-1/8	.405"	1
55369	16F78-20-20	1-1/4	1-1/4	2-1/8	.405"	1
55371	16F78-24-20	1-1/4	1-1/2	2-1/2	.495"	1

SAE (Code 62)
FLANGE 45° ELB.

16F78

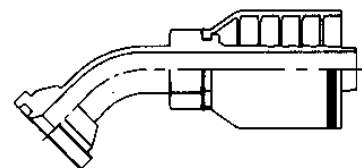

O-rings not included

PARKRIMP HOSE FITTINGS

78 SERIES

J&B #	PARKER #	HOSE SIZE	FLANGE SIZE	FLANGE O.D.	FLANGE HEIGHT	QTY
55395	1XA78-16-16	1	1	1-7/8	.560"	1
55397	1XA78-20-20	1-1/4	1-1/4	2-1/8	.560"	1
55399	1XA78-24-24	1-1/2	1-1/2	2-1/2	.560"	1

**CATERPILLAR STYLE
FLANGE STRAIGHT**

1XA78

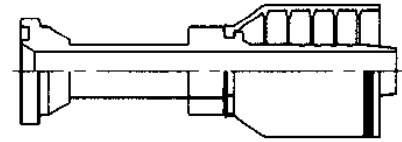

O-rings not included

J&B #	PARKER #	HOSE SIZE	FLANGE SIZE	FLANGE O.D.	FLANGE HEIGHT	QTY
55415	1XN78-16-16	1	1	1-7/8	.560"	1
55417	1XN78-20-16	1	1-1/4	2-1/8	.560"	1
55419	1XN78-20-20	1-1/4	1-1/4	2-1/8	.560"	1
55421	1XN78-24-24	1-1/2	1-1/2	2-1/2	.560"	1

**CATERPILLAR STYLE
FLANGE 90° ELBOW**

1XN78

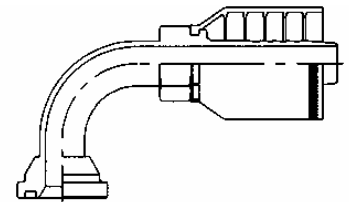

O-rings not included

J&B #	PARKER #	HOSE SIZE	FLANGE SIZE	FLANGE O.D.	FLANGE HEIGHT	QTY
55402	1XF78-16-16	1	1	1-7/8	.560"	1
55403	1XF78-20-16	1	1-1/4	2-1/8	.560"	1
55405	1XF78-20-20	1-1/4	1-1/4	2-1/8	.560"	1
55407	1XF78-24-24	1-1/2	1-1/2	2-1/2	.560"	1

**CATERPILLAR STYLE
FLANGE 45° ELBOW**

1XF78

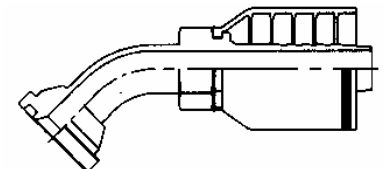

O-rings not included

PARKRIMP HOSE FITTINGS

78 SERIES

J&B #	PARKER #	HOSE SIZE	FLANGE SIZE	FLANGE O.D.	FLANGE HEIGHT	QTY
55434	1XE78-20-20	1-1/4	1-1/4	2-1/8	.560"	1

**CATERPILLAR STYLE
FLANGE 30° ELBOW**

1XE78

O-rings not included

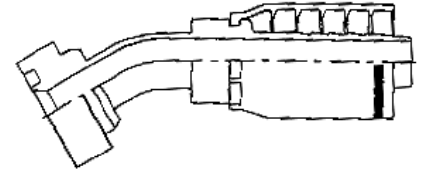

J&B #	PARKER #	HOSE SIZE	FLANGE SIZE	FLANGE O.D.	FLANGE HEIGHT	QTY
55428	1XG78-20-20	1-1/4	1-1/4	2-1/8	.560"	1

**CATERPILLAR STYLE
FLANGE 60° ELBOW**

1XG78

O-rings not included

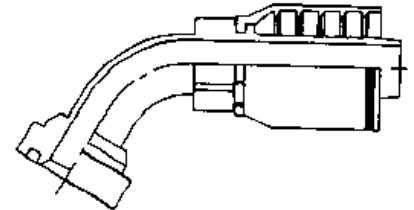

FLANGE "D" RING CATERPILLAR STYLE FLANGES

J&B #	FLANGE SIZE	PARKER #	DASH SIZE	I.D.	O.D.	QTY
55361	1	XARG-16	-16	0.20	1.25	1
55362	1-1/4	XARG-20	-20	0.20	1.50	1
55363	1-1/2	XARG-24	-24	0.20	1.75	1

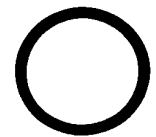

O-RING

PARKRIMP HOSE FITTINGS

78 SERIES

J&B #	PARKER #	HOSE SIZE	SEAL LOK		QTY
			SIZE	THREAD	
55697	1JS78-16-16	1	1	1-7/16-12	1
55698	1JS78-20-20	1-1/4	1-1/4	1-11/16-12	1
55699	1JS78-24-24	1-1/2	1-1/2	2-12	1

FEMALE "SEAL LOK"
SWIVEL STRAIGHT

1JS78

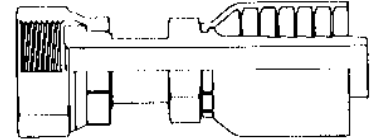

J&B #	PARKER #	HOSE SIZE	SEAL LOK		QTY
			SIZE	THREAD	
55707	1J978-16-16	1	1	1-7/16-12	1
55708	1J978-20-20	1-1/4	1-1/4	1-11/16-12	1
55709	1J978-24-24	1-1/2	1-1/2	2-12	1

FEMALE "SEAL LOK"
SWIVEL 90° ELBOW
(SHORT)

1J978

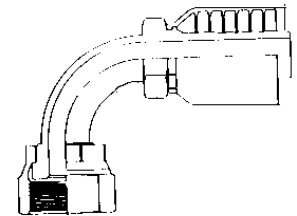

J&B #	PARKER #	HOSE SIZE	SEAL LOK		QTY
			SIZE	THREAD	
55702	1J778-16-16	1	1	1-7/16-12	1
55703	1J778-20-20	1-1/4	1-1/4	1-11/16-12	1
55704	1J778-24-24	1-1/2	1-1/2	2-12	1

FEMALE "SEAL LOK"
SWIVEL 45 ELBOW

1J778

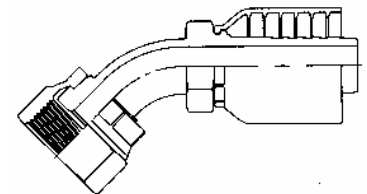

PARKRIMP HOSE FITTINGS

26 SERIES

Male Tube O-Ring Swivel - Straight, Short Pilot

1S526

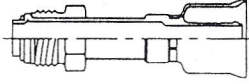

Thread Size	Tube Size	Hose Dash Size	Cut-off Allow.	Part No.	J&B NO
				1S526-6-6	55600
				1S526-8-8	55601
7/8x18	5/8	-10	2.56	1S526-10-10	55602
7/8x18	5/8	-12	2.57	1S526-10-12	55603

Male Tube O-Ring Swivel - 90° Elbow, Short Pilot with Charge Port for R12

15K26-PR

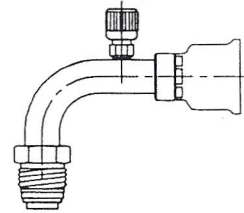

Thread Size	Tube Size	*Hose Dash Size	Cut-off Allow.	Part No.	J&B NO
7/8x18	5/8	-10	2.63	15K26-10-10-PR	55611
7/8x18	5/8	-12	2.64	15K26-10-12-PR	55612

Male Tube O-Ring Swivel - 45° Elbow, Short Pilot

15R26

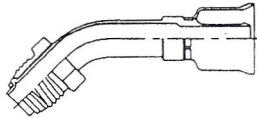

Thread Size	Tube Size	Hose Dash Size	Cut-off Allow.	Part No.	J&B NO
5/8x18	3/8	-6	2.12	15R26-6-6	55604
3/4x18	1/2	-8	2.17	15R26-8-8	55605
7/8x18	5/8	-10	2.64	15R26-10-10	55606
7/8x18	5/8	-12	2.65	15R26-10-12	55607

Male Tube O-Ring Swivel - Straight, Long Pilot with Charge Port for R134a

14526-PT

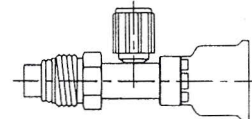

Thread Size	Tube Size	Hose Dash Size	Cut-off Allow.	Part No.	J&B NO
7/8x18	5/8	-12	2.54	14526-10-12-PT	55613

Male Tube O-Ring Swivel - 90° Elbow, Short Pilot

15K26

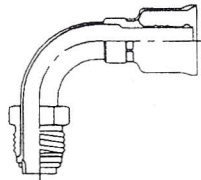

Thread Size	Tube Size	Hose Dash Size	Cut-off Allow.	Part No.	J&B NO
5/8x18	3/8	-6	1.35	15K26-6-6	55608
3/4x18	1/2	-8	2.02	15K26-8-8	55609
7/8x18	5/8	-10	1.70	15K26-10-10+	
7/8x18	5/8	-12	1.69	15K26-10-12	55610

-Non-standard.

PARKRIMP HOSE FITTINGS

26 SERIES

**Male Tube O-Ring Swivel -
90° Elbow, Long Pilot with
Charge Port for R12**

15M26-PR

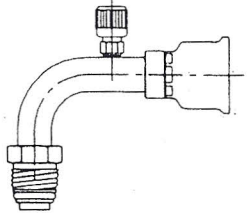

Thread Size	Tube Size	Hose Dash Size	Cut-off Allow.	Part No.	J&B NO
5/8x18	3/8	-6	2.19	15M26-6-6-PF	55614

**Male Tube O-Ring Rigid -
Straight, Internal Long Pilot**

15G26

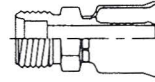

Thread Size	Tube Size	Hose Dash Size	Cut-off Allow.	Part No.	J&B NO
5/8x18	3/8	-6	0.92	15G26-6-6	55616
7/8x14	5/8	-10	1.25	15G26-10-10	55618
7/8x14	5/8	-12	1.25	15G26-10-12	55619
				15G26-8-8	55617

**Male Tube O-Ring Rigid -
Straight, Internal Long Pilot**

15G26-PR

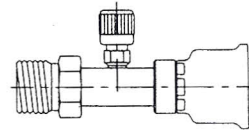

**Male Tube O-Ring Swivel -
90° Elbow, Long Pilot with
Charge Port for R134a**

15M26-PT

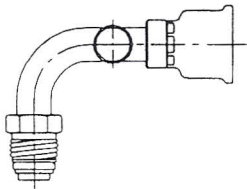

Thread Size	Tube Size	Hose Dash Size	Cut-off Allow.	Part No.	J&B NO
7/8x14	5/8	-12	2.88	15G26-10-12-PR	55620

**Female Tube O-Ring Swivel -
Straight, Short Pilot**

15S26

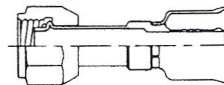

Thread Size	Tube Size	Hose Dash Size	Cut-off Allow.	Part No.	J&B NO
7/8x18	5/8	-12	2.64	15M26-10-12-PT	55615

Thread Size	Tube Size	Hose Dash Size	Cut-off Allow.	Part No.	J&B NO
5/8x18	3/8	-6	1.73	15S26-6-6	55621
3/4x16	1/2	-8	1.78	15S26-8-8	55622
7/8x14	5/8	-10	1.85	15S26-10-10	55623
7/8x14	5/8	-12	1.86	15S26-10-12	55624

PARKRIMP HOSE FITTINGS

26 SERIES

**Female Tube O-Ring Swivel
- 45° Elbow, Short Pilot**

15H26

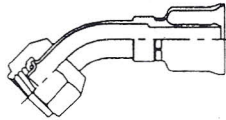

Thread Size	Tube Size	Hose Dash Size	Cut-off Allow.	Part No.	J&B NO
5/8x18	3/8	-6	1.54	15H26-6-6	55625
3/4x16	1/2	-8	1.68	15H26-8-8	55626
7/8x14	5/8	-10	2.07	15H26-10-10	55627
7/8x14	5/8	-12	2.08	15H26-10-12	55628

**Female Tube O-Ring Swivel
- 90° Elbow, Short Pilot**

15T26

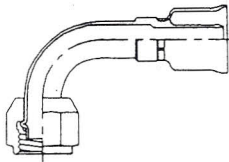

Thread Size	Tube Size	Hose Dash Size	Cut-off Allow.	Part No.	J&B NO
5/8x18	3/8	-6	1.35	15T26-6-6	55629
3/4x16	1/2	-8	1.62	15T26-8-8	55630
7/8x14	5/8	-10	1.94	15T26-10-10	55631
7/8x14	5/8	-12	1.95	15T26-10-12	55632

**Female Tube O-Ring Swivel
- Straight, Long Pilot with
Charge Port for R134a**

15926-PB & PT

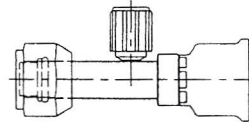

Thread Size	Tube Size	Hose Dash Size	Cut-off Allow.	Part No.	J&B NO
5/8x18	3/8	-6	2.40	15926-6-6-PB	55633
3/4x16	1/2	-8	2.04	15926-8-8-PB	55634
7/8x14	5/8	-12	2.54	15926-10-12-PT	55635

**Female Tube O-Ring Swivel
- 45° Elbow, Long Pilot with
Charge Port for R134a**

15N26-PB & PT

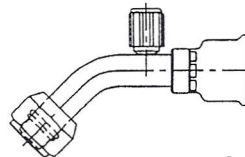

Thread Size	Tube Size	Hose Dash Size	Cut-off Allow.	Part No.	J&B NO
3/4x16	1/2	-8	2.85	15N26-8-8-PB	55636
7/8x14	5/8	-12	3.19	15N26-10-12-PT	55637

PARKRIMP HOSE FITTINGS

26 SERIES

**Female Tube O-Ring Swivel
- 90° Elbow, Long Pilot with
Charge Port for R12**

15L26-PR

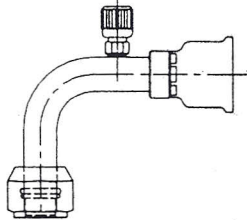

Thread Size	Tube Size	Hose Dash Size	Cut-off Allow.	Part No.	J&B NO
3/4x16	1/2	-8	2.37	15L26-8-8-PR	55638
7/8x14	5/8	-10	2.63	15L26-10-10-PR	55639
7/8x14	5/8	-12	2.64	15L26-10-12-PR	55640

**Male Tube O-Ring Swivel -
45° Elbow, Long Pilot with
Charge Port for R134a**

15P26-PT

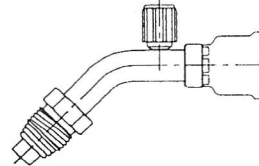

Thread Size	Tube Size	Hose Dash Size	Cut-off Allow.	Part No.	J&B NO
7/8x18	5/8	-12	3.09	15P26-10-12-PT	55645

**Female Tube O-Ring Swivel
- 90° Elbow, Long Pilot with
Charge Port for R134a**

15L26-PB & PT

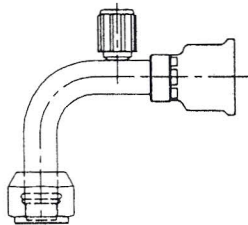

Thread Size	Tube Size	Hose Dash Size	Cut-off Allow.	Part No.	J&B NO
5/8x18	3/8	-6	2.19	15L26-6-6-PB	55641
3/4x16	1/2	-8	2.37	15L26-8-8-PB	55642
7/8x14	5/8	-10	2.63	15L26-10-10-PT	55643
7/8x14	5/8	-12	2.64	15L26-10-12-PT	55644

**Male Refrigerant Tube
Mender - Straight (with Nut
and Ferrule)**

1T126

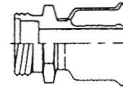

Thread Size	Tube Size	Hose Dash Size	Cut-off Allow.	Part No.	J&B NO
5/8x18	3/8	-6	1.10	1T126-6-6	55646
3/4x16	1/2	-8	1.21	1T126-8-8	55647
7/8x14	5/8	-10	1.33	1T126-10-10	55648
7/8x14	5/8	-12	1.33	1T126-10-12	55649
1-16x14	3/4	-12	1.39	1T126-12-12	55650

O-Rings

**For Tube O-Ring Air Conditioning
and Refrigeration Fittings.
(Compound N1173-70)***

Tube Size	I.D.	Part No.	J&B NO
3/8	.301±.005	771513-1	55651
1/2	.426±.005	771513-2	55652
5/8	.551±.005	771513-4	55653
3/4	.676±.005	771513-4	55654



*For use with R12 or R134a and

lubricants.

PARKRIMP HOSE FITTINGS

26 SERIES

J&B #	PARKER #	HOSE	TUBE		QTY
		SIZE	SIZE	THREAD	
55680	10826-6-6	-6	3/8	5/8-18	1

**FEMALE SAE 45
SWIVEL STRAIGHT**

10826

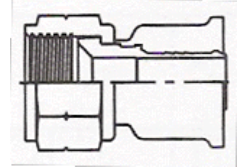

J&B #	PARKER #	HOSE	TUBE		QTY
		SIZE	SIZE	THREAD	
55669	16826-8-6	-6	1/2	3/4-16	1
55670	16826-8-8	-8	1/2	3/4-16	1
55671	16826-10-10	-10	5/8	7/8-14	1

**FEMALE JIC 37/SAE
45 SWIVEL -
STRAIGHT
(DUAL SEAT)**

16826

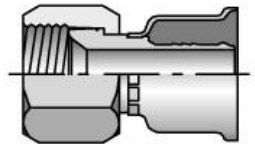

J&B #	PARKER #	HOSE	TUBE		QTY
		SIZE	SIZE	THREAD	
55665	10626-6-6	-6	3/8	9/16-18	1

**FEMALE JIC 37
SWIVEL**

10626

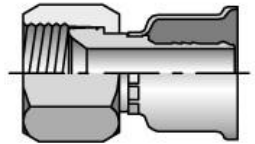

J&B #	PARKER #	HOSE	PIPE	QTY
		I.D.	THREAD	
55660	10126-4-6	3/8	1/4	1
55661	10126-6-6	3/8	3/8	1
55663	10126-8-8	1/2	1/2	1

**MALE NPTF PIPE -
RIGID**

10126

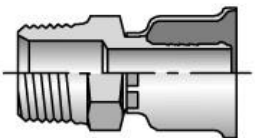

REUSABLE HOSE FITTINGS

20 SERIES

20 SERIES FITTINGS CAN BE USED WITH THE FOLLOWING HOSES

201 (SAE J1402 All)	MEDIUM PRESSURE HOSE -	Page 726
235 (SAE J51D)	LOW PRESSURE HOSE -	Page 722
SS25UL LPG	SERVICE HOSE -	Page 728

J&B #	PARKER #	HOSE SIZE	PIPE THREAD	QTY
51000	20120-2-4	-4	1/8	1
51002	20120-4-4	-4	1/4	1
51003	20120-4-5	-5	1/4	1
51004	20120-4-6	-6	1/4	1
51006	20120-6-6	-6	3/8	1
51008	20120-6-8	-8	3/8	1
51010	20120-8-8	-8	1/2	1
51012	20120-8-10	-10	1/2	1
51014	20120-12-12	-12	3/4	1
51016	20120-16-16	-16	1	1

**MALE PIPE
20120**

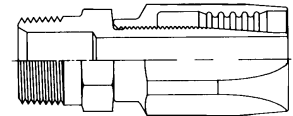

J&B #	PARKER #	HOSE SIZE	TUBE		QTY
			SIZE	THREAD	
51200	20420-4-4	-4	1/4	7/16-20	1
51202	20420-6-6	-6	3/8	5/8-18	1
51204	20420-8-8	-8	1/2	3/4-16	1
51203	20420-10-10	-10	5/8	7/8-14	1

**MALE SAE 45°
20420**

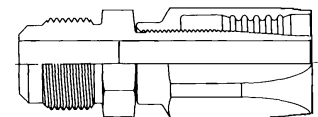

* Notch in hex for SAE 45° identification (for sizes -6 and -12 only.)

REUSABLE HOSE FITTINGS

20 SERIES

J&B #	PARKER #	HOSE SIZE	TUBE		QTY
			SIZE	THREAD	
51260	27920-4-4	-4	1/4	7/16-20	1
51261	27920-5-5	-5	5/16	1/2-20	1
* 51262	27920-6-6	-6	3/8	5/8-18	1
51264	27920-8-8	-8	1/2	3/4-16	1
51265	27920-10-10	-10	5/8	7/8-14	1

* SAE only. Will have notch on the nut. (for sizes -6 and -12 only.)

SAE 45°/ JIC 37°
SWIVEL 90°
ELBOW

27920

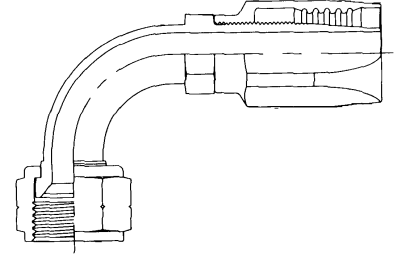

J&B #	PARKER #	HOSE SIZE	TUBE		QTY
			SIZE	THREAD	
52574	23720-4-4	-4	1/4	7/16-20	1
52576	23720-5-5	-5	5/16	1/2-20	1
* 52578	27720-6-6	-6	3/8	5/8-18	1
52580	23720-8-8	-8	1/2	3/4-16	1
52575	23720-10-10	-10	5/8	7/8-14	1

* SAE only. Will have notch on the nut. (for sizes -6 and -12 only.)

SAE 45°/ JIC 37°
SWIVEL 45°
ELBOW

27720

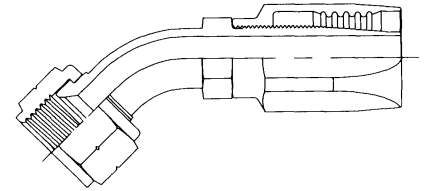

J&B #	PARKER #	HOSE SIZE	TUBE		QTY
			SIZE	THREAD	
51206	20820-4-4	-4	1/4	7/16-20	1
51205	20820-5-5	-5	5/16	1/2-20	1
* 51208	20820-6-6	-6	3/8	5/8-18	1
51210	20820-8-8	-8	1/2	3/4-16	1
51211	20620-10-8	-8	5/8	7/8-14	1
51212	20820-10-10	-10	5/8	7/8-14	1
* 51214	20820-12-12	-12	3/4	1-1/16-14	1

* SAE only. Will have notch on the nut. (for sizes -6 and -12 only.)

SAE 45°/ JIC 37°
SWIVEL

20820

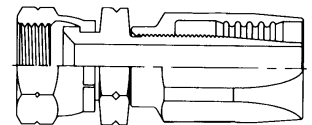

REUSABLE HOSE FITTINGS

20 SERIES

J&B #	PARKER #	HOSE SIZE	TUBE		QTY
			SIZE	THREAD	
51260	23920-4-4	-4	1/4	7/16-20	1
51261	23920-5-5	-5	5/16	1/2-20	1
* 51263	23920-6-6	-6	3/8	9/16-18	1
51264	23920-8-8	-8	1/2	3/4-16	1

* JIC 37 only / not SAE 45

SAE 45°/ JIC 37°
90° ELBOW

23920

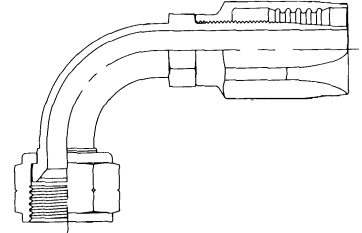

J&B #	PARKER #	HOSE SIZE	TUBE		QTY
			SIZE	THREAD	
52574	23720-4-4	-4	1/4	7/16-20	1
52576	23720-5-5	-5	5/16	1/2-20	1
* 52572	23720-6-6	-6	3/8	9/16-18	1
52580	23720-8-8	-8	1/2	3/4-16	1
52575	23720-10-10	-10	5/8	7/8-14	1

* JIC 37 only / not SAE 45

SAE 45°/ JIC 37°
45° ELBOW

23720

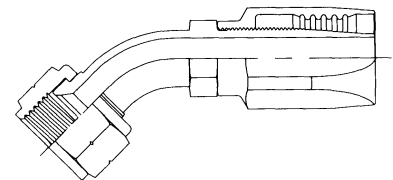

J&B #	PARKER #	HOSE SIZE	TUBE		QTY
			SIZE	THREAD	
52806	20320-6-6	-6	3/8	9/16-18	1

MALE
(JIC) 37° RIGID

20320

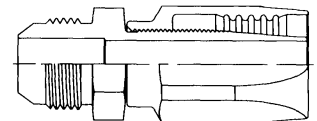

J&B #	PARKER #	HOSE SIZE	TUBE		QTY
			SIZE	THREAD	
51206	20620-4-4	-4	1/4	7/16-20	1
51205	20620-5-5	-5	5/16	1/2-20	1
* 52807	20620-6-6	-6	3/8	9/16-18	1
51210	20620-8-8	-8	1/2	3/4-16	1
51211	20620-10-8	-8	5/8	7/8-14	1
51212	20620-10-10	-10	5/8	7/8-14	1
* 52808	20620-12-12	-12	3/4	1-1/16-12	1
* 51216	20620-16-16	-16	1	1-5/16-12	1
* 51218	20620-20-20	-20	1-1/4	1-5/8-12	1

* JIC 37 only / not SAE 45

FEMALE
SAE 45°/ JIC 37°
SWIVEL

20620

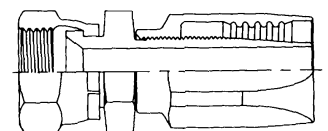

REUSABLE HOSE FITTINGS

20 SERIES

J&B #	PARKER #	HOSE SIZE	TUBE		QTY
			SIZE	THREAD	
51230	22820-4-4	-4	1/4	7/16-24	1
51231	22820-5-5	-5	5/16	1/2-20	1
51232	22820-6-6	-6	3/8	5/8-18	1
51234	22820-8-8	-8	1/2	3/4-18	1

SAE MALE INVERTED SWIVEL

22820

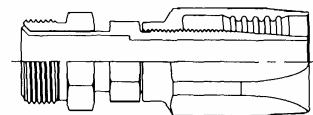

J&B #	PARKER #	HOSE SIZE	TUBE		QTY
			SIZE	THREAD	
51240	26720-4-4	-4	1/4	7/16-24	1
51242	26720-6-6	-6	3/8	5/8-18	1
51244	26720-8-8	-8	1/2	3/4-18	1

SAE MALE INVERTED SWIVEL 45° ELBOW

26720

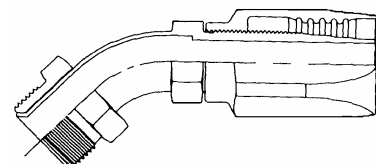

J&B #	PARKER #	HOSE SIZE	TUBE		QTY
			SIZE	THREAD	
51250	26920-4-4	-4	1/4	7/16-24	1
51251	26920-5-5	-5	5/16	1/2-20	1
51252	26920-6-6	-6	3/8	5/8-18	1

SAE MALE INVERTED SWIVEL 90° ELBOW

26920

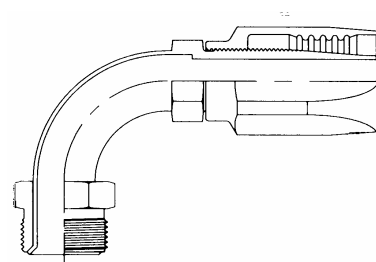

REUSABLE HOSE FITTINGS

20 SERIES "FERRUL-FIX"

Fast, On-The-Job Repair For Ruptured Bent Tube Hose Assemblies And Power Steering Lines

Problem . . .

The life of the combination tube-hose assembly is often limited to the service life of the hose alone. A replacement assembly may not be available, since equipment dealers are unable to stock all of the many odd tube configurations.

Solution . . .

Parker FERRUL-FIX, a field attachable, reusable hose end fitting, now makes it possible to salvage the bent tube section of the original assembly for replacement. Most important, it gets you back into operation FAST!

GETS YOU BACK IN OPERATION FAST - No costly delays while replacement assemblies are rushed from the factory.

LETS YOU REUSE EXPENSIVE BENT TUBE ENDS - You can replace the hose at a fraction of the cost of complete assembly.

ELIMINATES NEED FOR EMERGENCY BRAZING OR WELDING IN THE FIELD - Ferrul-Fix can be assembled without special tools or equipment.

Result . . .

Features . . .

3-Piece Design - body, nut, ferrule. Wedging action of ferrule, when drawn down by nut, forms seal between body and ferrule, while cutting edge of ferrule "bites" into tube wall forming another positive seal.

Visible Bite - Extent of bite at cutting edge of ferrule is completely visible when fitting is dis-assembled; an important safety feature. Self-centering action assures even bite around circumference of tube.

Parkerize Finish - Ferrul-Lok fittings have the Parkerize black finish, providing "built-in" lubrication which reduces wrench torque in make-up.

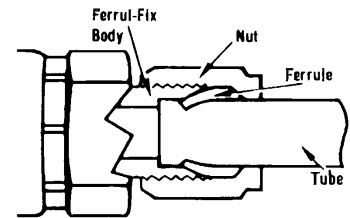

J&B #	PARKER #	HOSE I.D.	TUBE		QTY
			SIZE	THREAD	
52550	21120-6-6	3/8	3/8	9/16-18	1
52552	21120-8-8	1/2	1/2	3/4-16	1

(SAE Flareless)
"Ferrul-Fix"

21120

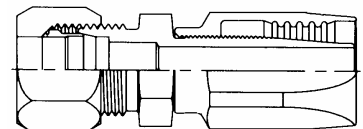

FERRUL-FIX INSTALLATION INSTRUCTIONS:

1. Cut the formed tube off squarely next to the permanent hose fitting. Lightly deburr the end of the tube internally and externally.
2. Disassemble the Ferrul-Fix fitting, and lubricate threads and both ends of the ferrule with an extreme pressure lubricant. Slide nut and ferrule onto tubing, with the long, straight end of the ferrule pointing toward the tube end.
3. Insert tube end into the Ferrul-Fix body until it bottoms against the shoulder. Slide ferrule inside body, and screw nut down finger tight.
4. Tighten nut with a wrench until tube no longer can be rotated easily. From this point, tighten nut one more complete turn. Disconnect nut and inspect lead edge of ferrule to make certain that the biting edge has turned up a shoulder completely around the tube.
5. Assemble Ferrul-Fix fitting to hose. Refer to assembly instructions listed in appropriate fittings section.
6. Reassemble tubing into Ferrul-Fix end and turn nut finger tight. Turn bent tube to proper position if required. Using two wrenches, one on the fitting nipple hex and the other on the nut, tighten nut from 1/6 to 1/3 turn.

REUSABLE HOSE FITTINGS

30 SERIES

30 SERIES FITTINGS CAN BE USED WITH THE FOLLOWING HOSE

302 (SAE 100R2 AT)

HIGH PRESSURE HOSE -

Page 730

J&B #	PARKER #	HOSE SIZE	TUBE		QTY
			SIZE	THREAD	
52400	20630-4-4	1/4	1/4	7/16-20	1
52402	20630-6-4	1/4	3/8	9/16-18	1
52404	20630-6-6	3/8	3/8	9/16-18	1
52406	20630-8-6	3/8	1/2	3/4-16	1
52408	20630-8-8	1/2	1/2	3/4-16	1
52410	20630-10-8	1/2	5/8	7/8-14	1
52411	20630-10-12	3/4	5/8	7/8-14	1
52412	20630-12-12	3/4	3/4	1-1/16-12	1
52413	20630-12-8	1/2	3/4	1-1/16-12	1
52416	20630-16-16	1	1	1-5/16-12	1

SAE (JIC) 37°
SWIVEL

20630

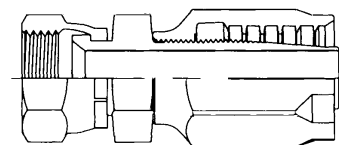

J&B #	PARKER #	HOSE SIZE	PIPE THREAD	QTY
52424	20130-4-4	1/4	1/4	1
52426	20130-6-6	3/8	3/8	1
52428	20130-8-6	3/8	1/2	1
52430	20130-8-8	1/2	1/2	1
52434	20130-12-8	1/2	3/4	1
52438	20130-12-12	3/4	3/4	1
52440	20130-12-16	1	3/4	1
52442	20130-16-16	1	1	1

MALE PIPE NPTF

20130

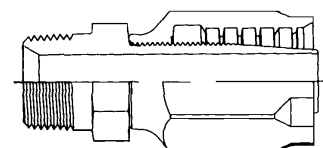

REUSABLE HOSE FITTINGS

30 SERIES

J&B #	PARKER #	HOSE SIZE	TUBE		QTY
			SIZE	THREAD	
52450	20330-8-8	1/2	1/2	3/4-16	1
52460	20330-12-12	3/4	3/4	1-1/16-12	1

MALE SAE
(JIC) 37°

20330

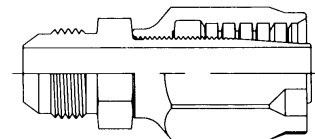

REUSABLE HOSE FITTINGS

88 SERIES

88 SERIES FITTINGS CAN BE USED WITH THE FOLLOWING HOSE

881 (SAE 100R4) VACUUM OR LOW PRESSURE HOSE - Page 720

J&B #	PARKER #	HOSE SIZE	PIPE THREAD	QTY
54350	0188-12-12	3/4	3/4-14	1
54352	0188-16-16	1	1- 11 1/2	1
^ 56100	0188-20-20	1-1/4	1-1/4- 11 1/2	1
56108	0188-24-24	1-1/2	1-1/2- 11 1/2	1

MALE PIPE NPTF

0188

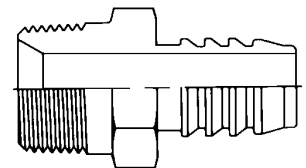

J&B #	PARKER #	HOSE SIZE	QTY
54360	88DB-12	3/4	1
54362	88DB-16	1	1
^ 56200	88DB-20	1-1/4	1

HEAVY DUTY HOSE CLAMP

88DB

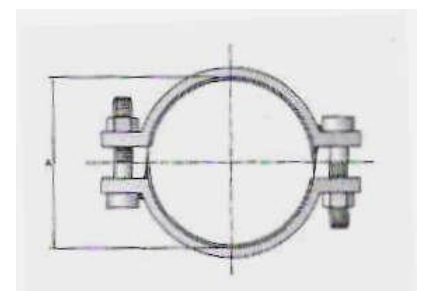

* Numbers with a “^” are not necessarily stocked in large quantities

PARKRIMP HOSE FITTINGS

STAINLESS STEEL 91 SERIES

91 SERIES FITTINGS CAN BE USED WITH THE FOLLOWING HOSE

919 (SAE 100R14) TFE STAINLESS MEDIUM PRESSURE HOSE Page 736

J&B #	PARKER #	HOSE SIZE	TUBE		QTY
			SIZE	THREAD	
56520	10691N-4-4C	-4	1/4	7/16-20	1
56521	10691N-5-5C	-5	5/16	1/2-20	1
56522	10691N-6-6C	-6	3/8	9/16-18	1

FEMALE SAE (JIC)
37° SWIVEL
STRAIGHT
10691N

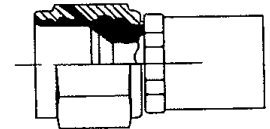

* 300 Series SS nipple, nut & shell

* Dual 37 degree / 45 degree seat on sizes -4 and -5.

REUSABLE HOSE FITTINGS

90 SERIES

90 SERIES FITTINGS CAN BE USED WITH THE FOLLOWING HOSE

919 (SAE 100R14) TFE STAINLESS MEDIUM PRESSURE HOSE Page 736

J&B #	PARKER #	HOSE SIZE	TUBE		QTY
			SIZE	THREAD	
51342	20690-10-10	-10	5/8	7/8-14	1

* Brass nipple, ferrule, steel socket

**SAE (JIC) 37°
SWIVEL**

20690

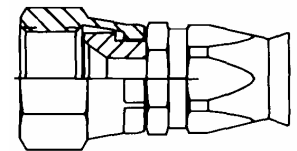

J&B #	PARKER #	HOSE SIZE	PIPE THREAD	QTY
51340	20190-8-10	-10	1/2-14	1

* Brass nipple, ferrule, steel socket

MALE PIPE

20190

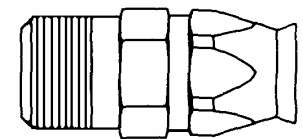

J&B #	PARKER #	HOSE SIZE	TUBE SIZE	QTY
51350	23490-10-10	-10	5/8	1

* Brass nipple, ferrule, steel socket
Use with HAB nut and sleeve

STRAIGHT TUBE

23490

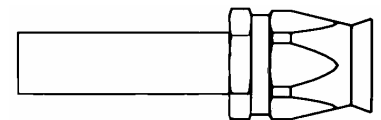

J&B #	PARKER #	HOSE SIZE	TUBE		QTY
			SIZE	THREAD	
51360	26190-8-10	-10	1/2	11/16-20	1
51362	26190-10-10	-10	5/8	13/16-18	1

* Brass nipple, ferrule, steel socket
Use with HAB nut and sleeve

**SAE COMPRESSION
AIR BRAKE**

26190



PARKRIMP HOSE FITTINGS

91 SERIES

91 SERIES FITTINGS CAN BE USED WITH THE FOLLOWING HOSE

919 (SAE 100R14) TFE STAINLESS MEDIUM PRESSURE HOSE Page 736

J&B #	PARKER #	HOSE SIZE	TUBE		QTY
			SIZE	THREAD	
55590	10691N-4-4	-4	1/4	7/16-20	1
55591	10691N-5-5	-5	5/16	1/2-20	1
42210	10691N-6-6	-6	3/8	9/16-18	1
55594	10691N-8-8	-8	1/2	3/4-16	1
55596	10691N-8-10	-10	1/2	7/8-14	1
42212	10691N-10-10	-10	5/8	7/8-14	1
42214	10691N-12-12	-12	3/4	1-1/6-12	1

**FEMALE SAE (JIC)
37° SWIVEL
STRAIGHT
10691N**

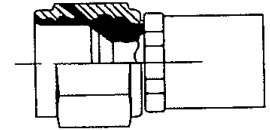

* Brass nipple, steel nut and shell

J&B #	PARKER #	HOSE SIZE	PIPE THREAD	QTY
55580	10191N-4-4	-4	1/4	1
57590	10191N-4-5	-5	1/4	1
55582	10191N-6-6	-6	3/8	1
55584	10191N-8-8	-8	1/2	1
55509	10191N-12-12	-12	3/4	1

**MALE PIPE
10191N**

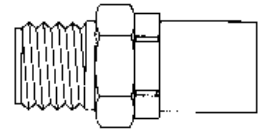

J&B #	PARKER #	HOSE SIZE	TUBE		QTY
			SIZE	THREAD	
55579	10891N-6-6	-6	3/8	5/8-18	1

**FEMALE SAE
45 SWIVEL
STRAIGHT
10891N**

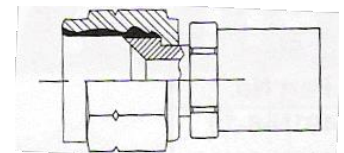

PARKRIMP HOSE FITTINGS

91 SERIES

91 SERIES FITTINGS CAN BE USED WITH THE FOLLOWING HOSE

919 (SAE 100R14) TFE STAINLESS MEDIUM PRESSURE HOSE Page 736

J&B #	PARKER #	HOSE SIZE	TUBE		QTY
			SIZE	THREAD	
^ 55575	16191N-10-10	-10	5/8	13/16-18	1

* Use with HAB nut and sleeve.

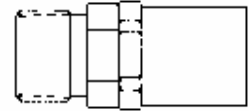

**COMPRESSION
AIR BRAKE
16191N**

J&B #	PARKER #	HOSE SIZE	TUBE SIZE	QTY
^ 55570	13491N-10-10	-10	5/8	1

* Numbers with a “^” are not necessarily stocked in large quantities.

* Without nut and ferrule.

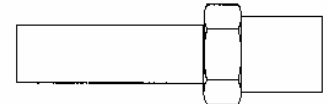

**STRAIGHT TUBE
13491N**

FLARETITE SEALS

304 STAINLESS STEEL SEALS

THE FLARED FITTING

Designed some 70 years ago the flared fitting offered manufacturers and users a cost effective easy to assemble small package size comprehensive range of fittings that has become Globally accepted.

COMMON ISSUES

Evolving higher pressure and more demanding duty cycle hydraulic systems exposed the metal to metal flare sealing face weakness of flared fittings making it very difficult to obtain a permanent leak free flared type fitting joint.

It has become the norm to expect a flared fitting to leak from misaligned flare fittings, during forging, flared surface damage and scratches or leakage caused by vibration in the field.

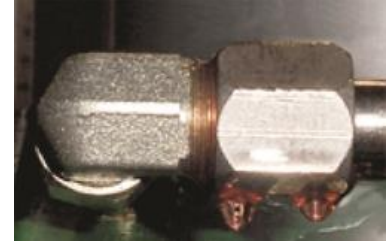

THE SOLUTION
FLARED FITTING + FLARETITE
 =
100% LEAK FREE JOINT

The Flaretite Seal is a stainless steel stamping, designed with multiple concentric rings. The entire seal is impregnated with a baked-on Loctite coating. When inserted into a flared fitting joint the concentric rings form multiple seals down the face of the flare and the Loctite coating fills minor imperfections. The sealing rings prevent environmental contamination and aggressive cleaning solvents from attacking the seal face and also protect the face from fretting, galling, over tightening and electrolysis. Unlike ORFS fittings Flaretite Seals will not embrittle, harden & fail like o-rings do. Flaretite Seals will not fail in a fire like o-rings, this prevents atomized oil from fueling combustion.

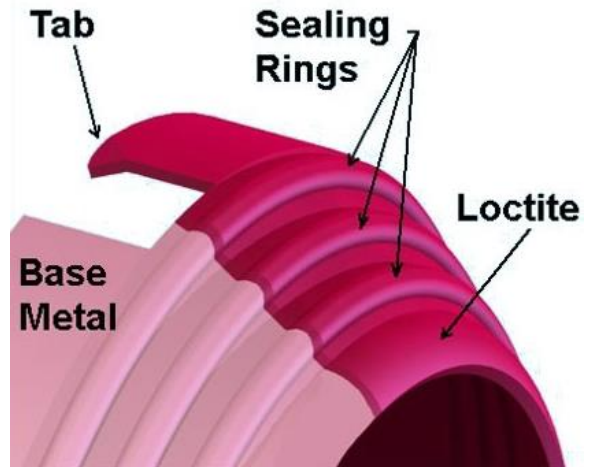

Independently tested by Eaton's Aeroquip hose & fittings division to one million high pressure square wave pulse cycles on badly scored JIC flared fitting faces without failure, this design, which easily installs by simply clipping over the male flare section, makes Flaretite Seals the single best choice "compliant seal" flared type fitting permanent leak free fix.

- 304 Stainless steel steel with Loctite Vibra Seal coating for standard carbon steel fittings.
- Rated for -40 to 300 F temperature and all common gases & fluids.

J&B #	37 DEGREE FLARE SIZE	DASH SIZE	QTY
59800	1/4	-4	5
59801	3/8	-6	5
59802	1/2	-8	5
59803	5/8	-10	5
59804	3/4	-12	5

ADAPTERS

37° FLARE STEEL ADAPTERS

- Parker steel adapters are furnished cadmium plated and are made from close grained non-porous steel forgings or steel bar stock.
- These adapters conform to the Hydraulic Tube Fitting Standard as published in J514 of the Society of Automotive Engineers (SAE) Handbook and to specifications of the former Joint Industry Conference (JIC) on Hydraulic Standards for Industrial Equipment.

J&B #	HOSE FITTING PART #	TUBE FITTING PART#	MALE JIC SIZE	MALE PIPE THREAD	QTY
55944	0103-2-2	2 FTX	1/8	1/8	1
55945	0103-2-3	3 FTX	3/16	1/8	1
52769	0103-2-4	4 FTX	1/4	1/8	1
51370	0103-4-4	4-4 FTX	1/4	1/4	1
51371	0103-6-4	4-6 FTX	1/4	3/8	1
55946	0103-8-4	4-8 FTX	1/4	1/2	1
55947	0103-2-5	5 FTX	5/16	1/8	1
51373	0103-4-5	5-4 FTX	5/16	1/4	1
57190	0103-6-5	5-6 FTX	5/16	3/8	1
55948	0103-2-6	6-2 FTX	3/8	1/8	1
52770	0103-4-6	6 FTX	3/8	1/4	1
51372	0103-6-6	6-6 FTX	3/8	3/8	1
52771	0103-8-6	6-8 FTX	3/8	1/2	1
57191	0103-12-6	6-12 FTX	3/8	3/4	1
57192	0103-2-8	8-2 FTX	1/2	1/8	1
52773	0103-4-8	8-4 FTX	1/2	1/4	1
52772	0103-6-8	8 FTX	1/2	3/8	1
51374	0103-8-8	8-8 FTX	1/2	1/2	1
52774	0103-12-8	8-12 FTX	1/2	3/4	1
57193	0103-16-8	8-16 FTX	1/2	1	1
52776	0103-6-10	10-6 FTX	5/8	3/8	1
52775	0103-8-10	10 FTX	5/8	1/2	1
52777	0103-12-10	10-12 FTX	5/8	3/4	1
57194	0103-6-12	12-6 FTX	3/4	3/8	1
52778	0103-8-12	12-8 FTX	3/4	1/2	1
51376	0103-12-12	12 FTX	3/4	3/4	1
51377	0103-16-12	12-16 FTX	3/4	1	1
57195	0103-20-12	12-20 FTX	3/4	1-1/4	1
55949	0103-12-14	14 FTX	7/8	3/4	1
51379	0103-12-16	16-12 FTX	1	3/4	1
51378	0103-16-16	16 FTX	1	1	1
51367	0103-20-16	16-20 FTX	1	1-1/4	1
52779	0103-16-20	20-16 FTX	1-1/4	1	1
51385	0103-20-20	20 FTX	1-1/4	1-1/4	1
55950	0103-20-24	24-20 FTX	1-1/2	1-1/4	1
51388	0103-24-24	24 FTX	1-1/2	1-1/2	1

**MALE
CONNECTOR
0103 (FTX)**

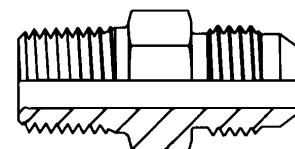

ADAPTERS

37° FLARE STEEL ADAPTERS

J&B #	HOSE FITTING PART #	TUBE FITTING PART #	MALE JIC SIZE	MALE PIPE THREAD	QTY
57213	2103-2-2	2 CTX	1/8	1/8	1
57214	2103-2-3	3 CTX	3/16	1/8	1
51369	2103-2-4	4 CTX	1/4	1/8	1
51380	2103-4-4	4-4 CTX	1/4	1/4	1
51387	2103-6-4	4-6 CTX	1/4	3/8	1
57216	2103-8-4	4-8 CTX	1/4	1/2	1
57217	2103-2-5	5 CTX	5/16	1/8	1
51375	2103-4-5	5-4 CTX	5/16	1/4	1
57219	2103-2-6	6-2 CTX	3/8	1/8	1
51381	2103-4-6	6 CTX	3/8	1/4	1
51382	2103-6-6	6-6 CTX	3/8	3/8	1
51389	2103-8-6	6-8 CTX	3/8	1/2	1
57221	2103-12-6	6-12 CTX	3/8	3/4	1
51368	2103-4-8	8-4 CTX	1/2	1/4	1
51383	2103-6-8	8 CTX	1/2	3/8	1
51384	2103-8-8	8-8 CTX	1/2	1/2	1
51391	2103-12-8	8-12 CTX	1/2	3/4	1
57222	2103-16-8	8-16 CTX	1/2	1	1
57223	2103-6-10	10-6 CTX	5/8	3/8	1
51390	2103-8-10	10 CTX	5/8	1/2	1
51392	2103-12-10	10-12 CTX	5/8	3/4	1
57224	2103-16-10	10-16 CTX	5/8	1	1
57226	2103-6-12	12-6 CTX	3/4	3/8	1
51393	2103-8-12	12-8 CTX	3/4	1/2	1
51386	2103-12-12	12 CTX	3/4	3/4	1
51394	2103-16-12	12-16 CTX	3/4	1	1
51397	2103-12-16	16-12 CTX	1	3/4	1
51395	2103-16-16	16 CTX	1	1	1
51399	2103-20-16	16-20 CTX	1	1-1/4	1
51398	2103-16-20	20-16 CTX	1-1/4	1	1
51400	2103-20-20	20 CTX	1-1/4	1-1/4	1
51396	2103-24-24	24 CTX	1-1/2	1-1/2	1

**90° MALE
ELBOW
2103 (CTX)**

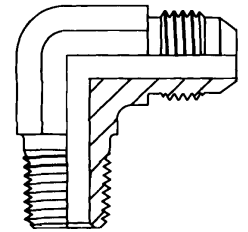

ADAPTERS

37° FLARE STEEL ADAPTERS

J&B #	HOSE FITTING PART #	TUBE FITTING PART #	MALE JIC SIZE	MALE PIPE THREAD	QTY
51369	2103-2-4	2 CTX	1/4	1/8	1
51380	2103-4-4	4-4 CTX	1/4	1/4	1
51387	2103-6-4	4-6 CTX	1/4	3/8	1
51375	2103-4-5	5-4 CTX	5/16	1/4	1
51381	2103-4-6	6 CTX	3/8	1/4	1
51382	2103-6-6	6-6 CTX	3/8	3/8	1
51389	2103-8-6	6-8 CTX	3/8	1/2	1
51368	2103-4-8	8-4 CTX	1/2	1/4	1
51383	2103-6-8	8 CTX	1/2	3/8	1
51384	2103-8-8	8-8 CTX	1/2	1/2	1
51391	2103-12-8	8-12 CTX	1/2	3/4	1
51390	2103-8-10	10 CTX	5/8	1/2	1
51392	2103-12-10	10-12 CTX	5/8	3/4	1
51393	2103-8-12	12-8 CTX	3/4	1/2	1
51386	2103-12-12	12 CTX	3/4	3/4	1
51394	2103-16-12	12-16 CTX	3/4	1	1
51397	2103-12-16	16-12 CTX	1	3/4	1
51395	2103-16-16	16 CTX	1	1	1
51399	2103-20-16	16-20 CTX	1	1-1/4	1
51398	2103-16-20	20-16 CTX	1-1/4	1	1
51400	2103-20-20	20 CTX	1-1/4	1-1/4	1
51396	2103-24-24	24 CTX	1-1/2	1-1/2	1

**90° MALE
ELBOW
2103 (CTX)**

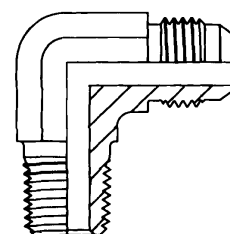

J&B #	HOSE FITTING PART #	TUBE FITTING PART #	MALE JIC SIZE	MALE PIPE THREAD	QTY
54049	3103-2-4	4 VTX	1/4	1/8	1
52494	3103-4-4	4-4 VTX	1/4	1/4	1
54050	3103-6-4	4-6 VTX	1/4	3/8	1
52496	3103-4-6	6 VTX	3/8	1/4	1
52501	3103-6-6	6-6 VTX	3/8	3/8	1
52502	3103-8-6	6-8 VTX	3/8	1/2	1
52498	3103-6-8	8 VTX	1/2	3/8	1
52500	3103-8-8	8-8 VTX	1/2	1/2	1
52780	3103-12-8	8-12 VTX	1/2	3/4	1
52503	3103-8-10	10 VTX	5/8	1/2	1
52505	3103-12-10	10-12 VTX	5/8	3/4	1
52499	3103-8-12	12-8 VTX	3/4	1/2	1
52504	3103-12-12	12 VTX	3/4	3/4	1
54052	3103-16-12	12-16 VTX	3/4	1	1
52510	3103-16-16	16 VTX	1	1	1
54053	3103-20-20	20 VTX	1-1/4	1-1/4	1
54054	3103-24-24	24 VTX	1-1/2	1-1/2	1

**45° MALE
ELBOW
3103 (VTX)**

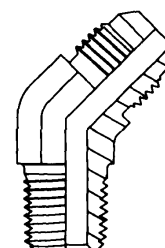

ADAPTERS

37° FLARE STEEL ADAPTERS

J&B #	HOSE FITTING PART #	TUBE FITTING PART #	JIC TUBE SIZE	STRAIGHT THREAD	QTY
54324	06B-4	4 BTX	1/4	7/16-20	1
54326	06B-6	6 BTX	3/8	9/16-18	1
54328	06B-8	8 BTX	1/2	3/4-16	1
54329	06B-10	10 BTX	5/8	7/8-14	1
54330	06B-12	12 BTX	3/4	1-1/16-12	1
54332	06B-16	16 BTX	1	1-5/16-12	1
54333	06B-20	20 BTX	1-1/4	1-5/8-12	1
54331	06B-24	24 BTX	1-1/2	1-7/8-12	1

**NUT
06B (BTX)**

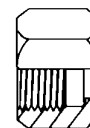

J&B #	HOSE FITTING PART #	TUBE FITTING PART #	JIC TUBE SIZE	QTY
54334	06S-4	4 TX	1/4	1
54336	06S-6	6 TX	3/8	1
54338	06S-8	8 TX	1/2	1
54339	06S-10	10 TX	5/8	1
54340	06S-12	12 TX	3/4	1
54342	06S-16	16 TX	1	1

**INCH SLEEVE
06S (TX)**

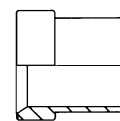

J&B #	HOSE FITTING PART #	TUBE FITTING PART #	MALE JIC SIZE S	QTY
55980	2353-4-4	4 WETX-WLN	1/4	1
55982	2353-6-6	6 WETX-WLN	3/8	1
55983	2353-8-8	8 WETX-WLN	1/2	1
55984	2353-10-10	10 WETX-WLN	5/8	1
55985	2353-12-12	12 WETX-WLN	3/4	1

**BULKHEAD UNION
90° ELBOW
2353 (WETX-WLN)**

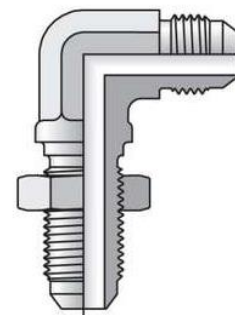

ADAPTERS

37° FLARE STEEL ADAPTERS

J&B #	HOSE FITTING PART #	TUBE FITTING PART #	MALE JIC SIZE	SWIVEL JIC NUT	QTY
54284	3903-4-4	4 C6X	1/4	1/4	1
54285	3903-5-5	5 C6X	5/16	5/16	1
54286	3903-6-6	6 C6X	3/8	3/8	1
54288	3903-8-8	8 C6X	1/2	1/2	1
54289	3903-10-10	10 C6X	5/8	5/8	1
54290	3903-12-12	12 C6X	3/4	3/4	1
54291	3903-16-16	16 C6X	1	1	1
54293	3903-20-20	20 C6X	1-1/4	1-1/4	1

**SWIVEL NUT
90° ELBOW
3903 (C6X)**

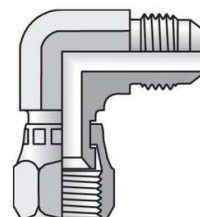

J&B #	HOSE FITTING PART #	TUBE FITTING PART #	MALE JIC SIZE	FEMALE PIPE THREAD	QTY
52364	2203-4-4	4-4 DTX	1/4	1/4	1
52366	2203-6-6	6-6 DTX	3/8	3/8	1
52368	2203-8-8	8-8 DTX	1/2	1/2	1

**FEMALE
90° ELBOW
2203 (DTX)**

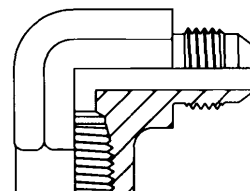

J&B #	HOSE FITTING PART #	TUBE FITTING PART #	MALE JIC SIZE	FEMALE PIPE THREAD	QTY
52593	0203-4-4	4-4 GTX	1/4	1/4	1
52594	0203-6-6	6-6 GTX	3/8	3/8	1
52595	0203-8-8	8-8 GTX	1/2	1/2	1

**FEMALE
CONNECTOR
0203 (GTX)**

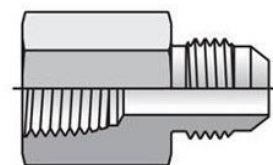

ADAPTERS

37° FLARE STEEL ADAPTERS

**TUBE END
REDUCER
1 PIECE**

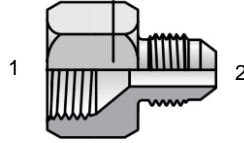

0603 (TRTXN)

**TUBE END
REDUCER
INSERT ONLY**

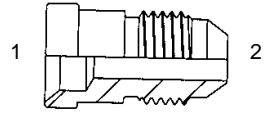

0603 (TRTX)

J&B #	HOSE FITTING PART #	TUBE FITTING PART #	TUBE O.D. REDUCTION	(2) TUBE END UN/UNF-2A	(1) TUBE END UN/UNF-2B	QTY
52961	0603-6-4	6-4 TRTX	3/8 to 1/4	7/16-20	9/16-18	1
52958	0603-8-4	8-4 TRTX	1/2 to 1/4	7/16-20	3/4-16	1
52962	0603-8-6	8-6 TRTX	1/2 to 3/8	9/16-18	3/4-16	1
*52964	*0603-10-8	10-8 TRTXN	5/8 to 1/2	3/4-16	7/8-14	1
52960	0603-12-6	12-6 TRTX	3/4 to 3/8	9/16-18	1-1/16-12	1
52965	0603-12-8	12-8 TRTX	3/4 to 1/2	3/4-16	1-1/16-12	1
*52966	*0603-12-10	12-10 TRTXN	3/4 to 5/8	7/8-14	1-1/16-12	1
*52963	*0603-14-12	14-12 TRTXN	7/8 to 3/4	1-1/16-12	1-3/16-12	1
52968	0603-16-12	16-12 TRTX	1 to 3/4	1-1/16-12	1-5/16-12	1
52972	0603-20-12	20-12 TRTX	1-1/4 to 3/4	1-1/16-12	1-5/8-12	1
52967	0603-20-16	20-16 TRTX	1-1/4 to 1	1-5/16-12	1-5/8-12	1
52969	0603-24-20	24-20 TRTX	1-1/2 to 1-1/4	1-5/8-12	1-7/8-12	1

* Comes with an O6B(BTX) nut attached. For all other sizes, order O6B(BTX) nut separately on page 770A.

J&B #	HOSE FITTING PART #	TUBE FITTING PART #	MALE JIC SIZE	QTY
55450	0353-4-4	4 WTX	1/4	1
55452	0353-6-6	6 WTX	3/8	1
55454	0353-8-8	8 WTX	1/2	1
55480	0353-10-10	10 WTX	5/8	1
55456	0353-12-12	12 WTX	3/4	1

**BULKHEAD UNION
0353 (WTX-WLN)**

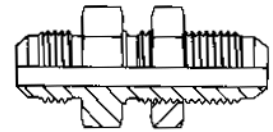

J&B #	HOSE FITTING PART #	TUBE FITTING PART #	JIC TUBE SIZES	SWIVEL JIC NUT	QTY
55500	393T-4-4	4 S6X	1/4	1/4	1
55502	393T-6-6	6 S6X	3/8	3/8	1
55504	393T-8-8	8 S6X	1/2	1/2	1
55506	393T-10-10	10 S6X	5/8	5/8	1
55508	393T-12-12	12 S6X	3/4	3/4	1

**SWIVEL NUT
BRANCH TEE
393T (S6X-S)**

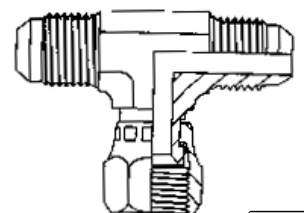

ADAPTERS

37° FLARE STEEL ADAPTERS

J&B #	HOSE FITTING PART #	TUBE FITTING PART #	JIC TUBE SIZE	QTY
54103	03CP-3	3 PTNX	3/16	1
54104	03CP-4	4 PTNX	1/4	1
54105	03CP-5	5 PTNX	5/16	1
54106	03CP-6	6 PTNX	3/8	1
54108	03CP-8	8 PTNX	1/2	1
54110	03CP-10	10 PTNX	5/8	1
54112	03CP-12	12 PTNX	3/4	1
54114	03CP-14	14 PTNX	7/8	1
54116	03CP-16	16 PTNX	1	1
54118	03CP-20	20 PTNX	1-1/4	1
54119	03CP-24	24 PTNX	1-1/2	1

PLUG
03CP (PNTX)

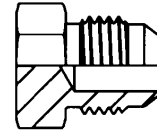

J&B #	HOSE FITTING PART #	TUBE FITTING PART #	JIC TUBE SIZE	QTY
54123	06CP-3	3 FNTX	3/16	1
54124	06CP-4	4 FNTX	1/4	1
54125	06CP-5	5 FNTX	5/16	1
54126	06CP-6	6 FNTX	3/8	1
54128	06CP-8	8 FNTX	1/2	1
54130	06CP-10	10 FNTX	5/8	1
54132	06CP-12	12 FNTX	3/4	1
54131	06CP-14	14 FNTX	7/8	1
54133	06CP-16	16 FNTX	1	1
54135	06CP-20	20 FNTX	1-1/4	1
54137	06CP-24	24 FNTX	1-1/2	1

CAP
06CP (FNTX)

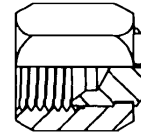

J&B #	HOSE FITTING PART #	TUBE FITTING PART #	SWIVEL JIC NUT	SWIVEL JIC NUT	QTY
56530	0606-4-4	4 HX6	1/4	1/4	1
56531	0606-6-6	6 HX6	3/8	3/8	1
56532	0606-8-8	8 HX6	1/2	1/2	1
56533	0606-10-10	10 HX6	5/8	5/8	1
56534	0606-12-12	12 HX6	3/4	3/4	1
56535	0606-16-16	16 HX6	1	1	1

SWIVEL NUT UNION

0606 (HX6)

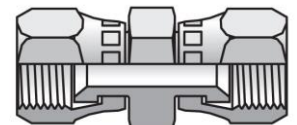

ADAPTERS

37° FLARE STEEL ADAPTERS

J&B #	HOSE FITTING PART #	TUBE FITTING PART #	SWIVEL JIC NUT	MALE PIPE THREAD	QTY
56360	0106-4-4	4-4 F6X	1/4	1/4	1
56362	0106-4-5	5-4 F6X	5/16	1/4	1
56364	0106-4-6	6 F6X	3/8	1/4	1
56366	0106-6-6	6-6 F6X	3/8	3/8	1
56368	0106-6-8	8 F6X	1/2	3/8	1
56369	0106-8-8	8-8 F6X	1/2	1/2	1
56370	0106-8-10	10 F6X	5/8	1/2	1
56372	0106-12-12	12 F6X	3/4	3/4	1
56373	0106-12-16	16-12 F6X	1"	3/4	1
56374	0106-16-16	16 F6X	1"	1"	1

**SWIVEL NUT
MALE
CONNECTOR
0106 (F6X-S)**

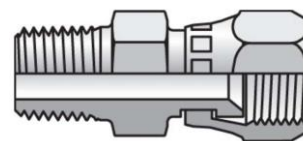

J&B #	HOSE FITTING PART #	TUBE FITTING PART #	MALE JIC SIZE	SWIVEL JIC NUT	QTY
56340	3703-4-4	4 V6X	1/4	1/4	1
56342	3703-5-5	5 V6X	5/16	5/16	1
56344	3703-6-6	6 V6X	3/8	3/8	1
56346	3703-8-8	8 V6X	1/2	1/2	1
56348	3703-10-10	10 V6X	5/8	5/8	1
56350	3703-12-12	12 V6X	3/4	3/4	1
56352	3703-16-16	16 V6X	1	1	1

**SWIVEL NUT
45° ELBOW
3703 (V6X-S)**

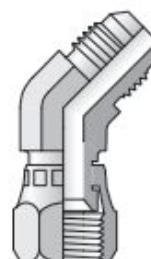

J&B #	HOSE FITTING PART #	TUBE FITTING PART #	SWIVEL JIC NUT	FEMALE PIPE THREAD	QTY
57440	0206-4-4	4-4 G6X	1/4	1/4	1
56320	0206-6-6	6-6 G6X	3/8	3/8	1
56322	0206-6-8	8 G6X	1/2	3/8	1
56324	0206-8-8	8-8 G6X	1/2	1/2	1
56326	0206-8-10	10 G6X	5/8	1/2	1
56328	0206-12-12	12 G6X	3/4	3/4	1
57441	0206-16-16	16 G6X	1	1	1

**SWIVEL NUT
FEMALE
CONNECTOR
0206 (G6X)**

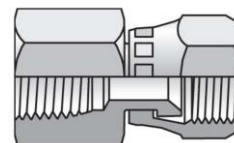

ADAPTERS

37° FLARE STEEL ADAPTERS

J&B #	HOSE FITTING PART #	TUBE FITTING PART #	SWIVEL JIC NUT	MALE PIPE THREAD	QTY
58157	2106-4-4	4-4 X6EF	1/4	1/4	1
58158	2106-4-6	6 X6EF	3/8	1/4	1
58159	2106-6-6	6-6 X6EF	3/8	3/8	1
58160	2106-6-8	8 X6EF	1/2	3/8	1
58161	2106-8-8	8-8 X6EF	1/2	1/2	1
58162	2106-8-10	10 X6EF	5/8	1/2	1
58163	2106-12-12	12 X6EF	3/4	3/4	1
58164	2106-16-16	16 X6EF	1"	1"	1

**SWIVEL NUT
90° ELBOW**

2106 (X6EF-S)

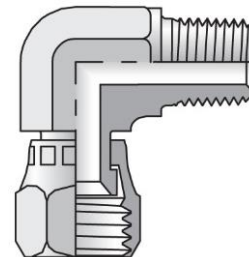

ADAPTERS

37° FLARE STEEL ADAPTERS

J&B #	HOSE FITTING PART #	TUBE FITTING PART #	MALE JIC SIZE	MALE JIC SIZE	QTY
51365	0303-3-3	3 HTX	3/16	3/16	1
51402	0303-4-4	4 HTX	1/4	1/4	1
51403	0303-5-5	5 HTX	5/16	5/16	1
51401	0303-4-6	6-4 HTX	3/8	1/4	1
51404	0303-6-6	6 HTX	3/8	3/8	1
51405	0303-6-8	8-6 HTX	1/2	3/8	1
51406	0303-8-8	8 HTX	1/2	1/2	1
51407	0303-10-10	10 HTX	5/8	5/8	1
51411	0303-10-12	12-10 HTX	3/4	5/8	1
51408	0303-12-12	12 HTX	3/4	3/4	1
51413	0303-14-12	14-12 HTX	7/8	3/4	1
51409	0303-12-16	16-12 HTX	1	3/4	1
51410	0303-16-16	16 HTX	1	1	1
51412	0303-20-20	20 HTX	1-1/4	1-1/4	1

UNION
0303 (HTX-S)

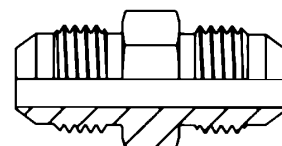

J&B #	HOSE FITTING PART #	TUBE FITTING PART #	MALE JIC SIZES	QTY
51420	033T-4-4	4 JTX	1/4	1
51422	033T-6-6	6 JTX	3/8	1
51424	033T-8-8	8 JTX	1/2	1
51426	033T-10-10	10 JTX	5/8	1
51429	033T-12-12	12 JTX	3/4	1
51431	033T-16-16	16 JTX	1	1

UNION TEE
033T (JTX-S)

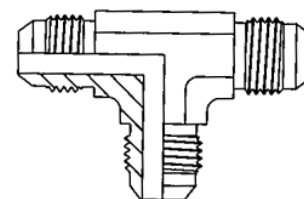

J&B #	HOSE FITTING PART #	TUBE FITTING PART #	MALE JIC SIZES	SWIVEL JIC NUT	QTY
51428	063T-4-4	4 R6X	1/4	1/4	1
51430	063T-6-6	6 R6X	3/8	3/8	1
51432	063T-8-8	8 R6X	1/2	1/2	1
51434	063T-10-10	10 R6X	5/8	5/8	1
51436	063T-12-12	12 R6X	3/4	3/4	1
51438	063T-16-16	16 R6X	1	1	1

SWIVEL NUT
RUN TEE
063T (R6X-S)

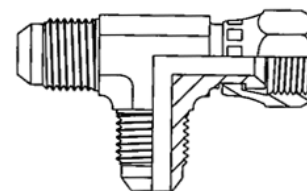

J&B #	HOSE FITTING PART #	TUBE FITTING PART #	MALE JIC SIZES	QTY
52566	2303-4-4	4 ETX	1/4	1
52567	2303-6-6	6 ETX	3/8	1
52568	2303-8-8	8 ETX	1/2	1
52569	2303-10-10	10 ETX	5/8	1
52571	2303-12-12	12 ETX	3/4	1

UNION ELBOW
2303 (ETX-S)

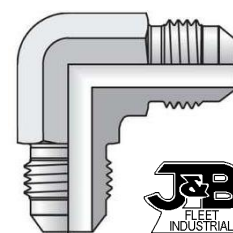

ADAPTERS

STAINLESS STEEL 37° FLARE STEEL ADAPTERS

J&B #	HOSE FITTING PART #	TUBE SIZE	PIPE THREAD	QTY
V53090	0103-4-4C	1/4	1/4	1
V53091	0103-6-6C	3/8	3/8	1
V53092	0103-8-8C	1/2	1/2	1
V53094	0103-12-12C	3/4	3/4	1
V53095	0103-16-16C	1	1	1
V53096	0103-20-20C	1-1/4	1-1/4	1

MALE CONNECTOR 0103 (FTX)

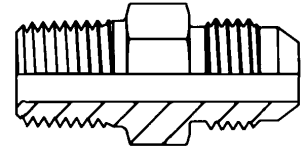

J&B #	HOSE FITTING PART #	TUBE SIZE	PIPE THREAD	QTY
V53098	2103-4-4C	1/4	1/4	1
V53099	2103-6-6C	3/8	3/8	1
V53100	2103-8-8C	1/2	1/2	1
V53102	2103-12-12C	3/4	3/4	1
V53104	2103-16-16C	1	1	1

MALE ELBOW 2103 (CTX)

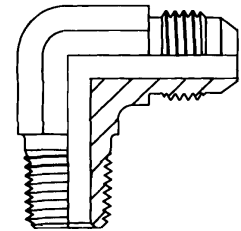

ADAPTERS

37° FLARE STEEL ADAPTERS "WITH O-RING"

J&B #	HOSE FITTING PART #	TUBE FITTING PART #	MALE JIC SIZE	O-RING BOSS THREAD	QTY
52385	0503-2-2	2 F5OX	1/8	5/16-24	1
55956	0503-3-3	3 F5OX	3/16	3/8-24	1
55954	0503-2-4	4-2 F5OX	1/4	5/16-24	1
55955	0503-3-4	4-3 F5OX	1/4	3/8-24	1
52388	0503-4-4	4 F5OX	1/4	7/16-20	1
55957	0503-5-4	4-5 F5OX	1/4	1/2-20	1
52389	0503-6-4	4-6 F5OX	1/4	9/16-18	1
55958	0503-8-4	4-8 F5OX	1/4	3/4-16	1
57181	0503-10-4	4-10 F5OX	1/4	7/8-14	1
57182	0503-4-5	5-4 F5OX	5/16	7/16-20	1
52395	0503-5-5	5 F5OX	5/16	1/2-20	1
55959	0503-6-5	5-6 F5OX	5/16	9/16-18	1
52396	0503-4-6	6-4 F5OX	3/8	7/16-20	1
55960	0503-5-6	6-5 F5OX	3/8	1/2-20	1
52390	0503-6-6	6 F5OX	3/8	9/16-18	1
52397	0503-8-6	6-8 F5OX	3/8	3/4-16	1
52399	0503-10-6	6-10 F5OX	3/8	7/8-14	1
57184	0503-12-6	6-12 F5OX	3/8	1-1/16-12	1
57185	0503-4-8	8-4 F5OX	1/2	7/16-20	1
52401	0503-6-8	8-6 F5OX	1/2	9/16-18	1
52392	0503-8-8	8 F5OX	1/2	3/4-16	1
52403	0503-10-8	8-10 F5OX	1/2	7/8-14	1
54218	0503-12-8	8-12 F5OX	1/2	1-1/16-12	1
57186	0503-16-8	8-16 F5OX	1/2	1-5/16-12	1
57187	0503-6-10	10-6 F5OX	5/8	9/16-18	1
52422	0503-8-10	10-8 F5OX	5/8	3/4-16	1
52393	0503-10-10	10 F5OX	5/8	7/8-14	1
55961	0503-12-10	10-12 F5OX	5/8	1-1/16-12	1
57188	0503-16-10	10-16 F5OX	5/8	1-5/16-12	1
52405	0503-8-12	12-8 F5OX	3/4	3/4-16	1
52398	0503-10-12	12-10 F5OX	3/4	7/8-14	1
52394	0503-12-12	12 F5OX	3/4	1-1/16-12	1
55962	0503-14-12	12-14 F5OX	3/4	1-3/16-12	1
54217	0503-16-12	12-16 F5OX	3/4	1-5/16-12	1
57189	0503-20-12	12-20 F5OX	3/4	1-5/8-12	1
52407	0503-14-14	14 F5OX	7/8	1-3/16-12	1
55963	0503-16-14	14-16 F5OX	7/8	1-5/16-12	1
55964	0503-10-16	16-10 F5OX	1	7/8-14	1
55965	0503-12-16	16-12 F5OX	1	1-1/16-12	1
55966	0503-14-16	16-14 F5OX	1	1-3/16-12	1
52409	0503-16-16	16 F5OX	1	1-5/16-12	1
54220	0503-20-16	16-20 F5OX	1	1-5/8-12	1
55967	0503-16-20	20-16 F5OX	1-1/4	1-5/16-12	1
54221	0503-20-20	20 F5OX	1-1/4	1-5/8-12	1

**STRAIGHT
THREAD
CONNECTOR
0503 (F5OX)**

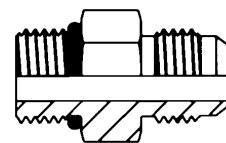

ADAPTERS

37° FLARE STEEL ADAPTERS "WITH O-RING"

J&B #	HOSE FITTING PART #	TUBE FITTING PART #	SWIVEL JIC NUT	O-RING BOSS THREAD	QTY
51440	0506-4-4	4 F65OX	1/4	7/16-20	1
51442	0506-5-5	5 F65OX	5/16	1/2-20	1
51443	0506-6-6	6 F65OX	3/8	9/16-18	1
51446	0506-8-8	8 F65OX	1/2	3/4-16	1
51449	0506-10-10	10 F65OX	5/8	7/8-14	1
51452	0506-12-12	12 F65OX	3/4	1-1/16-14	1
51455	0506-16-16	16 F65OX	1	1-5/16-12	1
51457	0506-20-20	20 F65OX	1-1/4	1-5/8-12	1

**SWIVEL STRAIGHT
THREAD
CONNECTOR
JIC SWIVEL /
ORB
0506 (F65OX)**

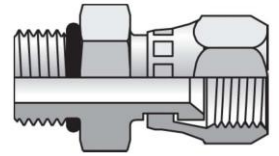

J&B #	HOSE FITTING PART #	TUBE FITTING PART #	SWIVEL JIC NUT	O-RING BOSS THREAD	QTY
57227	2506-4-4	4 AOEX6	1/4	7/16-20	1
57229	2506-6-6	6 AOEX6	3/8	9/16-18	1
57336	2506-8-8	8 AOEX6	1/2	3/4-16	1
57337	2506-10-10	10 AOEX6	5/8	7/8-14	1
57344	2506-12-12	12 AOEX6	3/4	1-1/16-14	1
57345	2506-16-16	16 AOEX6	1	1-5/16-12	1

**SWIVEL 90
THREAD
CONNECTOR
JIC SWIVEL /
ORB
2506 (AOEX6)**

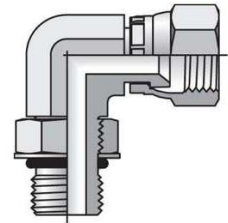

J&B #	HOSE FITTING PART #	TUBE FITTING PART #	O-RING BOSS THREAD	QTY
54640	05CP-2	2 P5ON	5/16-24	1
54641	05CP-3	3 P5ON	3/8-24	1
54642	05CP-4	4 P5ON	7/16-20	1
54643	05CP-5	5 P5ON	1/2-20	1
54644	05CP-6	6 P5ON	9/16-18	1
54645	05CP-8	8 P5ON	3/4-16	1
54646	05CP-10	10 P5ON	7/8-14	1
54647	05CP-12	12 P5ON	1-1/16-12	1
54650	05CP-14	14 P5ON	1-3/16-12	1
54648	05CP-16	16 P5ON	1-5/16-12	1
54649	05CP-20	20 P5ON	1-5/8-12	1

**HEX HEAD PLUG
05CP (P5ON-S)**

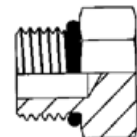

ADAPTERS

37° FLARE STEEL ADAPTERS "WITH O-RING"

J&B #	HOSE FITTING PART #	TUBE FITTING PART #	MALE JIC SIZE	O-RING BOSS THREAD	QTY
57197	2503-3-3	3 C5OX	3/16	3/8-24	1
57198	2503-2-4	4-2 C5OX	1/4	5/16-24	1
52370	2503-4-4	4 C5OX	1/4	7/16-20	1
52371	2503-6-4	4-6 C5OX	1/4	9/16-18	1
57199	2503-8-4	4-8 C5OX	1/4	3/4-16	1
57200	2503-4-5	5-4 C5OX	5/16	7/16-20	1
52372	2503-5-5	5 C5OX	5/16	1/2-20	1
57201	2503-6-5	5-6 C5OX	5/16	9/16-18	1
52383	2503-4-6	6-4 C5OX	3/8	7/16-20	1
57202	2503-5-6	6-5 C5OX	3/8	1/2-20	1
52380	2503-6-6	6 C5OX	3/8	9/16-18	1
52377	2503-8-6	6-8 C5OX	3/8	3/4-16	1
57203	2503-10-6	6-10 C5OX	3/8	7/8-14	1
52362	2503-4-8	8-4 C5OX	1/2	7/16-20	1
52378	2503-6-8	8-6 C5OX	1/2	9/16-18	1
52384	2503-8-8	8 C5OX	1/2	3/4-16	1
52414	2503-10-8	8-10 C5OX	1/2	7/8-14	1
52379	2503-12-8	8-12 C5OX	1/2	1-1/16-12	1
57204	2503-16-8	8-16 C5OX	1/2	1-5/16-12	1
52382	2503-8-10	10-8 C5OX	5/8	3/4-16	1
52381	2503-10-10	10 C5OX	5/8	7/8-14	1
57206	2503-12-10	10-12 C5OX	5/8	1-1/16-12	1
57208	2503-8-12	12-8 C5OX	3/4	3/4-16	1
52363	2503-10-12	12-10 C5OX	3/4	7/8-14	1
52386	2503-12-12	12 C5OX	3/4	1-1/16-12	1
57209	2503-14-12	12-14 C5OX	3/4	1-3/16-12	1
52415	2503-16-12	12-16 C5OX	3/4	1-5/16-12	1
57211	2503-20-12	12-20 C5OX	3/4	1-5/8-12	1
52387	2503-16-16	16 C5OX	1	1-5/16-12	1
52417	2503-20-20	20 C5OX	1-1/4	1-5/8-12	1

90° STRAIGHT
THREAD ELBOW
2503 (C5OX)

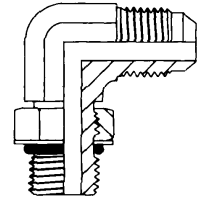

ADAPTERS

37° FLARE STEEL ADAPTERS "WITH O-RING"

J&B #	HOSE FITTING PART#	TUBE FITTING PART #	MALE JIC SIZE	O-RING BOSS THREAD	QTY
52512	3503-4-4	4 V5OX	1/4	7/16-20	1
52514	3503-5-5	5 V5OX	5/16	1/2-20	1
52516	3503-6-6	6 V5OX	3/8	9/16-18	1
52520	3503-8-8	8 V5OX	1/2	3/4-16	1
52522	3503-10-10	10 V5OX	5/8	7/8-14	1
52524	3503-12-12	12 V5OX	3/4	1-1/16-14	1
52525	3503-16-16	16 V5OX	1	1-5/16-12	1

**45° STRAIGHT
THREAD ELBOW
3503 (V5OX)**

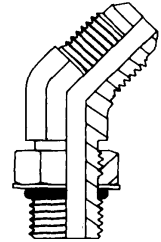

J&B #	HOSE FITTING PART #	TUBE FITTING PART #	MALE JIC SIZE	O-RING BOSS THREAD	QTY
54605	5503-4-4	4 CC5OX	1/4	7/16-20	1
54606	5503-6-6	6 CC5OX	3/8	9/16-18	1
54607	5503-8-8	8 CC5OX	1/2	3/4-16	1
54608	5503-12-12	12 CC5OX	3/4	1-1/16-12	1

**90° LONG STR.
THREAD ELBOW
5503 (CC5OX-S)**

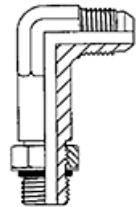

J&B #	HOSE FITTING PART #	TUBE FITTING PART #	MALE JIC SIZE	O-RING BOSS THREAD	QTY
52540	253T-6-6	6 S5OX	3/8	9/16-18	1
52553	253T-8-8	8 S5OX	1/2	3/4-16	1

**STRAIGHT
THREAD BRANCH
TEE
253T (S5OX)**

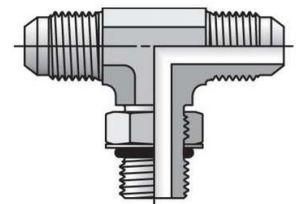

ADAPTERS

SAE STRAIGHT THREAD PORT O-RING

90 Durometer Nitrile

J&B #	PARKER #	HPD#S	DASH SIZE	END SIZE	WIDTH	I.D.	QTY
56260	3-904 N0552	711509-1	-4	1/4	0.07	0.35	1
56262	3-905 N0552	711509-2	-5	5/16	0.07	0.41	1
56264	3-906 N0552	711509-3	-6	3/8	0.08	0.47	1
56266	3-908 N0552	711509-4	-8	1/2	0.09	0.64	1
56268	3-910 N0552	711509-5	-10	5/8	0.10	0.76	1
56270	3-912 N0552	711509-6	-12	3/4	0.12	0.92	1
56271	3-914 N0552	711509-11	-14	7/8	0.12	1.05	1
56272	3-916 N0552	711509-7	-16	1	0.12	1.17	1
56274	3-920 N0552	711509-8	-20	1-1/4	0.12	1.48	1

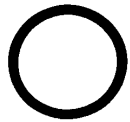

O-RING

J&B #	HOSE FITTING PART #	TUBE FITTING PART #	FEMALE PIPE THREAD	O-RING BOSS THREAD	QTY
54627	0502-4-4	4-1/4 F5OG	1/4-18	7/16-20	1
54628	0502-5-4	5-1/4 F5OG	1/4-18	1/2-20	1
54630	0502-6-4	6-1/4 F5OG	1/4-18	9/16-18	1
55937	0502-8-4	8-1/4 F5OG	1/4-18	3/4-16	1
54631	0502-6-6	6-3/8 F5OG	3/8-18	9/16-18	1
54632	0502-8-6	8-3/8 F5OG	3/8-18	3/4-16	1
54633	0502-10-6	10-3/8 F5OG	3/8-18	7/8-14	1
55938	0502-6-8	6-1/2 F5OG	1/2-14	9/16-18	1
54635	0502-8-8	8-1/2 F5OG	1/2-14	3/4-16	1
54634	0502-10-8	10-1/2 F5OG	1/2-14	7/8-14	1
54636	0502-12-8	12-1/2 F5OG	1/2-14	1-1/16-12	1
55939	0502-10-12	10-3/4 F5OG	3/4-14	7/8-14	1
54639	0502-12-12	12-3/4 F5OG	3/4-14	1-1/16-12	1
54637	0502-14-12	14-3/4 F5OG	3/4-14	1-3/16-12	1
54638	0502-16-12	16-3/4 F5OG	3/4-14	1-5/16-12	1

FEMALE PIPE ADAPTER
0502 (F5OG-S)

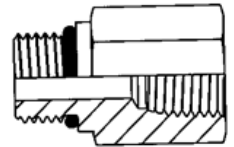

J&B #	HOSE FITTING PART #	TUBE FITTING PART #	FEMALE STRAIGHT THREAD	MALE PIPE THREAD	QTY
51416	1/4-6 FHG5	1/4-6 FHG5	9/16-18	1/4-18	1
51417	3/8-6 FHG5	3/8-6 FHG5	9/16-18	3/8-18	1
51418	3/8-8 FHG5	3/8-8 FHG5	3/4-16	3/8-18	1
51419	1/2-6 FHG5	1/2-6 FHG5	9/16-18	1/2-14	1
51421	1/2-8 FHG5	1/2-8 FHG5	3/4-16	1/2-14	1
51423	1/2-10 FHG5	1/2-10 FHG5	7/8-14	1/2-14	1
51425	3/4-8 FHG5	3/4-8 FHG5	3/4-16	3/4-16	1
51427	3/4-12 FHG5	3/4-12 FHG5	1-1/16-12	3/4-16	1

FEMALE STRAIGHT THREAD ADAPTER
0110 (FHG5-S)

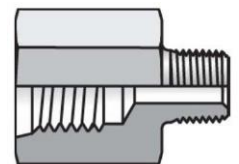

ADAPTERS

J&B #	TUBE FITTING PART #	MALE PIPE THREAD	O-RING BOSS THREAD	QTY
55385	5-1/4 F5OF	1/4	1/2-20	1
55448	6-1/4 F5OF	1/4	9/16-18	1
55449	6-3/8 F5OF	3/8	9/16-18	1
55389	8-3/8 F5OF	3/8	3/4-16	1
55390	8-1/2 F5OF	1/2	3/4-16	1
55391	10-1/2 F5OF	1/2	7/8-14	1
55392	12-1/2 F5OF	1/2	1-1/16-12	1
55393	12-3/4 F5OF	3/4	1-1/16-12	1
55394	16-3/4 F5OF	3/4	1-5/16-12	1

MALE PIPE/ ORB F5OF

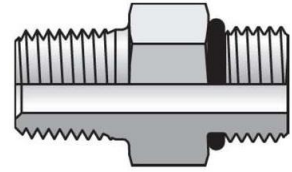

CODE 61 FLANGE HEAD PLUG FITTING

- Used to plug up where code 61 flange head fittings are installed.



(bottom view)



(top view)

J&B #	PARKER #	FLANGE SIZE	FLANGE O.D.	FLANGE HEIGHT	QTY
55990	12PQ1SX	3/4	1-1/2	.265"	1
55991	16PQ1SX	1"	1-3/4	.315"	1
55992	20PQ1SX	1-1/4	2	.315"	1

* O-rings not included. They are located on page 744.

METRIC ADAPTERS

37° FLARE STEEL ADAPTERS

J&B #	PARKER #	INCH SIZE JIC 37°(1)	MALE METRIC STRAIGHT THREAD (2)	QTY
^53020	4M10C8OMXS	1/4	M10 x 1	1
^55557	5M12C8OMXS	5/16	M12 x 1.5	1
^53022	6M14C8OMXS	3/8	M14 x 1.5	1
^53023	8M16C8OMXS	1/2	M16 x 1.5	1

**Male Elbow
Metric Straight
Thread (C8OMXS)**

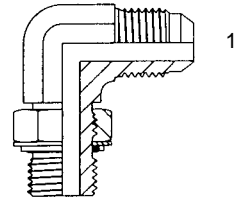

J&B #	PARKER #	INCH SIZE JIC 37°(1)	MALE METRIC STRAIGHT THREAD (2)	QTY
^53010	4M10F8OMXS	1/4	M10 x 1	1
^55558	5M12F8OMXS	5/16	M12 x 1.5	1
^53012	6M14F8OMXS	3/8	M14 x 1.5	1
^53013	8M16F8OMXS	1/2	M16 x 1.5	1

**Male Connector
Metric Straight
Thread (F8OMXS)**

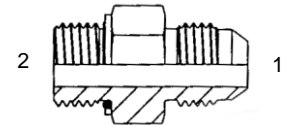

J&B #	PARKER #	INCH SIZE JIC 37°(1)	BSPP MALE PIPE THREAD (2)	QTY
^52985	4-4C4OMXS	1/4	1/4	1
^52987	6C4OMXS	3/8	1/4	1
^52988	6-6C4OMXS	3/8	3/8	1
^52991	8-8C4OMXS	1/2	1/2	1

**Male Elbow
BSPP (C4OMXS)**

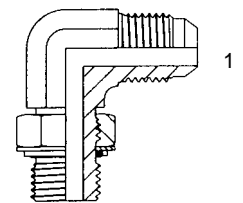

J&B #	PARKER #	INCH SIZE JIC 37°(1)	BSPP MALE PIPE THREAD (2)	QTY
^52970	4F4OMXS	1/4	1/8	1
^52971	4-4F4OMXS	1/4	1/4	1
^52976	6F4OMXS	3/8	1/4	1
^52977	6-6F4OMXS	3/8	3/8	1
^52980	8-8F4OMXS	1/2	1/2	1

**Male Connector
BSPP (F4OMXS)**

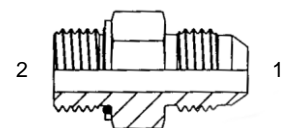

* Numbers with a "A" are not necessarily stocked in large quantities

METRIC ADAPTERS

37° FLARE STEEL ADAPTERS

J&B #	PARKER #	INCH SIZE JIC 37°(1)	BSPT MALE PIPE THREAD (2)	QTY
53060	4-4C3MXS	1/4	1/4	1
53063	6C3MXS	3/8	1/4	1
53064	6-6C3MXS	3/8	3/8	1
53068	8-8C3MXS	1/2	1/2	1

Male Elbow
BSPT (C3MXS)

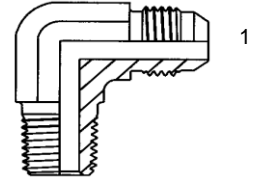

2

J&B #	PARKER #	INCH SIZE JIC 37°(1)	BSPT MALE PIPE THREAD (2)	QTY
53040	4F3MXS	1/4	1/8	1
53041	4-4F3MXS	1/4	1/4	1
53044	6F3MXS	3/8	1/4	1
53045	6-6F3MXS	3/8	3/8	1
53049	8-8F3MXS	1/2	1/2	1

Male
Connector
BSPT (F3MXS)

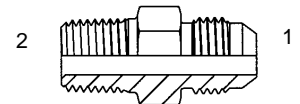

J&B #	PARKER #	BSPT MALE	NPT FEMALE	QTY
55481	3/8X3/8F3HG-S	3/8	3/8	1
55484	3/4X3/4F3HG-S	3/4	3/4	1

Conversion
Adapter
BSPT (F3HG)

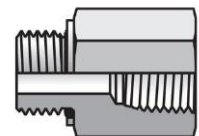

J&B #	PARKER #	BSPP MALE	NPT FEMALE	QTY
55567	1/4X1/4F4OHG-S	1/4	1/4	1
55490	3/8X3/8F4OHG-S	3/8	3/8	1
55568	1/2X1/2F4OHG-S	1/2	1/2	1
55566	1/2X3/4F4OHG-S	3/4	1/2	1
55494	3/4X3/4F4OHG-S	3/4	3/4	1

Conversion
Adapter
BSPP (F4OHG)

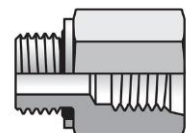

METRIC ADAPTERS

METRIC STRAIGHT THREAD PLUG 7408

J&B #	MFG #	MALE METRIC STRAIGHT THREAD	QTY
55496	7408-14	M14 x 1.50	1
55497	7408-16	M16 x 1.50	1
55499	7408-18	M18 x 1.50	1
55498	7408-20	M20 x 1.50	1

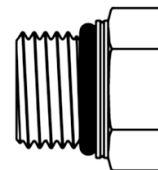

J&B #	PARKER #	METRIC STRAIGHT MALE	NPT FEMALE	QTY
55560	M12-1/4F8OHG-S	M12x1.5	1/4	1
55561	M14-1/4F8OHG-S	M14x1.5	1/4	1
55562	M16-3/8F8OHG-S	M16x1.5	3/8	1
55563	M16-1/2F8OHG-S	M16x1.5	1/2	1
55564	M18-3/8F8OHG-S	M18x1.5	3/8	1
55565	M18-1/2F8OHG-S	M18x1.5	1/2	1

Conversion Adapter METRIC-ORR (F8OHG)

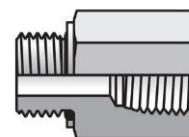

ADAPTERS

STEEL PIPE (HYDRAULIC)

- Parker steel adapters are furnished cadmium plated and are made from close grained non-porous steel forgings or steel bar stock.
- These adapters have Dryseal American (National Standard) taper (N.P.T.F.) pipe threads and unified class 2A male and 2B female straight threads.

J&B #	HOSE FITTING PART #	PIPE THREAD	QTY
54152	01CP-2	1/8	1
54154	01CP-4	1/4	1
54156	01CP-6	3/8	1
54158	01CP-8	1/2	1
54160	01CP-12	3/4	1
54161	01CP-16	1	1
54162	01CP-20	1-1/4	1

HEX HEAD PLUG

01CP (HP)

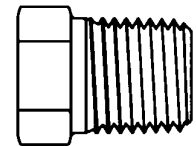

J&B #	HOSE FITTING PART #	FEMALE PIPE	FEMALE PIPE	QTY
54083	0202-2-2	1/8	1/8	1
54087	0202-2-4	1/4	1/8	1
54084	0202-4-4	1/4	1/4	1
54185	0202-4-6	3/8	1/4	1
54086	0202-6-6	3/8	3/8	1
54189	0202-6-8	1/2	3/8	1
54088	0202-8-8	1/2	1/2	1
54191	0202-8-12	3/4	1/2	1
54092	0202-12-12	3/4	3/4	1
54093	0202-16-16	1	1	1
54193	0202-20-20	1-1/4	1-1/4	1

PIPE COUPLING

0202 (GG)

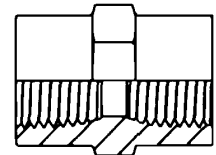

J&B #	HOSE FITTING PART #	MALE PIPE	FEMALE PIPE	QTY
52781	2102-2-2	1/8	1/8	1
52782	2102-4-4	1/4	1/4	1
52783	2102-6-6	3/8	3/8	1
52784	2102-8-8	1/2	1/2	1
54260	2102-12-12	3/4	3/4	1
54262	2102-16-16	1	1	1
54261	2102-20-20	1-1/4	1-1/4	1

STREET ELBOW

2102 (CD)

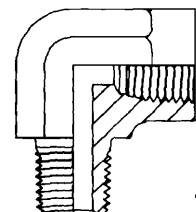

ADAPTERS

STEEL PIPE (HYDRAULIC)

J&B #	HOSE FITTING PART #	MALE PIPE	MALE PIPE	QTY
52577	0101-2-2	1/8	1/8	1
52579	0101-2-4	1/4	1/8	1
52581	0101-4-4	1/4	1/4	1
52583	0101-4-6	3/8	1/4	1
52582	0101-6-6	3/8	3/8	1
52589	0101-6-8	1/2	3/8	1
52584	0101-8-8	1/2	1/2	1
52591	0101-8-12	3/4	1/2	1
52586	0101-12-12	3/4	3/4	1
52587	0101-16-16	1	1	1
55972	0101-20-20	1-1/4	1-1/4	1

PIPE NIPPLE

0101 (FF)

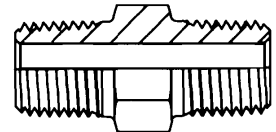

J&B #	HOSE FITTING PART #	PIPE THREAD	QTY
55900	2202-2-2	1/8	1
54184	2202-4-4	1/4	1
54186	2202-6-6	3/8	1
54188	2202-8-8	1/2	1
54190	2202-12-12	3/4	1
54192	2202-16-16	1	1
54195	2202-20-20	1-1/4	1

FEMALE PIPE ELBOW

2202 (DD)

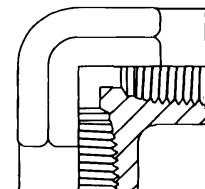

J&B #	HOSE FITTING PART #	PIPE THREAD	QTY
55902	022T-2-2	1/8	1
54194	022T-4-4	1/4	1
54196	022T-6-6	3/8	1
54198	022T-8-8	1/2	1
54200	022T-12-12	3/4	1
54201	022T-16-16	1	1
55974	022T-20-20	1-1/4	1

FEMALE PIPE TEE

022T (MMO)

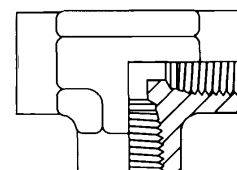

ADAPTERS

STEEL PIPE (HYDRAULIC)

J&B #	HOSE FITTING PART #	PIPE THREAD	QTY
55968	212T-2-2	1/8	1
55904	212T-4-4	1/4	1
55905	212T-6-6	3/8	1
55906	212T-8-8	1/2	1
55907	212T-12-12	3/4	1

MALE BRANCH TEE

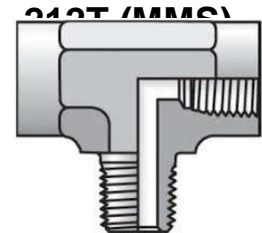

J&B #	HOSE FITTING PART #	PIPE THREAD	QTY
55969	012T-2-2	1/8	1
55910	012T-4-4	1/4	1
55911	012T-6-6	3/8	1
55912	012T-8-8	1/2	1
55913	012T-12-12	3/4	1

MALE RUN TEE

012T (MRO)

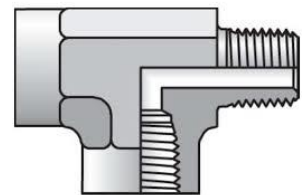

J&B #	HOSE FITTING PART #	PIPE THREAD	QTY
55916	4202-4-4	1/4	1
55917	4202-6-6	3/8	1
55918	4202-8-8	1/2	1
55919	4202-12-12	3/4	1

FEMALE PIPE ELBOW

4202 (DD45)

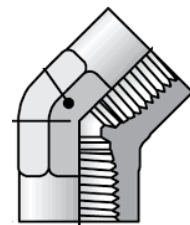

J&B #	HOSE FITTING PART #	PIPE THREAD	QTY
55921	2101-2-2	1/8	1
55922	2101-4-4	1/4	1
55923	2101-6-6	3/8	1
55924	2101-8-8	1/2	1
55925	2101-12-12	3/4	1
58168	2101-16-16	1	1
58169	2101-20-20	1-1/4	1

MALE PIPE ELBOW

2101 (CR)

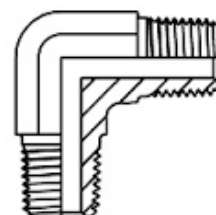

ADAPTERS

STEEL PIPE (HYDRAULIC)

J&B #	HOSE FITTING PART #	MALE PIPE	FEMALE PIPE	QTY
52900	0102-4-2	1/4	1/8	1
58170	0102-6-2	3/8	1/8	1
52901	0102-6-4	3/8	1/4	1
52902	0102-8-4	1/2	1/4	1
52903	0102-8-6	1/2	3/8	1
52909	0102-12-6	3/4	3/8	1
52906	0102-12-8	3/4	1/2	1
52911	0102-16-8	1	1/2	1
52912	0102-16-12	1	3/4	1
58172	0102-20-12	1-1/4	3/4	1
52915	0102-20-16	1-1/4	1	1
58174	0102-24-16	1-1/2	1	1
52916	0102-24-20	1-1/2	1-1/4	1

PIPE THREAD REDUCER
0102 (PTR)

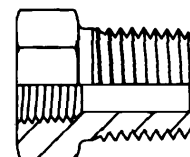

J&B #	HOSE FITTING PART #	MALE PIPE	FEMALE PIPE	QTY
56219	3102-2-2	1/8	1/8	1
56220	3102-4-4	1/4	1/4	1
56222	3102-6-6	3/8	3/8	1
53070	3102-8-8	1/2	1/2	1
53071	3102-12-12	3/4	3/4	1
58183	3102-16-16	1	1	1
58184	3102-20-20	1-1/4	1-1/4	1

45° STREET ELBOW
3102 (CD45)

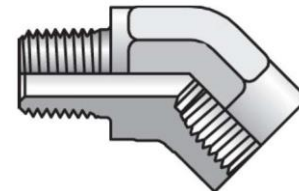

J&B #	HOSE FITTING PART #	MALE PIPE	FEMALE PIPE	QTY
53703	0201-4-2	1/8	1/4	1
56244	0201-6-4	1/4	3/8	1
56246	0201-8-6	3/8	1/2	1
56248	0201-12-8	1/2	3/4	1
56250	0201-16-12	3/4	1	1
53705	0201-20-16	1	1-1/4	1

Expander/ Adapter
0201 (FG)

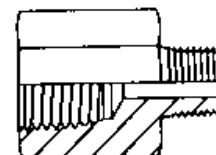

J&B #	TUBE FITTING PART #	PIPE THREAD	QTY
55457	1/8 HPC	1/8	1
55458	1/4 HPC	1/4	1
55459	3/8 HPC	3/8	1
55477	1/2 HPC	1/2	1
55478	3/4 HPC	3/4	1

HEX PIPE CAP
HPC

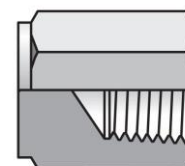

ADAPTERS

FEMALE PIPE SWIVEL

- Parker steel adapters are furnished cadmium plated and are made from close grained non-porous steel forgings or steel bar stock.
- The female swivel end of these adapters is a straight pipe thread (NPSM) with a 30 degree seat. All male pipe fittings that are used with these female pipe swivel adapters must have a 30 degree seat in order to effect a proper seal. Parker male pipe hose fittings and male by female pipe swivel adapters contain this 30 degree seat.

J&B #	HOSE FITTING PART #	MALE PIPE	FEMALE PIPE	QTY
52918	0107-2-2	1/8	1/8	1
52919	0107-2-4	1/8	1/4	1
52920	0107-4-4	1/4	1/4	1
52921	0107-4-6	1/4	3/8	1
52923	0107-6-4	3/8	1/4	1
52922	0107-6-6	3/8	3/8	1
52924	0107-6-8	3/8	1/2	1
52925	0107-8-6	1/2	3/8	1
52926	0107-8-8	1/2	1/2	1
52927	0107-8-12	1/2	3/4	1
52929	0107-12-8	3/4	1/2	1
52928	0107-12-12	3/4	3/4	1
52931	0107-12-16	3/4	1	1
52930	0107-16-16	1	1	1
52933	0107-16-20	1	1-1/4	1
52935	0107-20-20	1-1/4	1-1/4	1

MALE PIPE ADAPTER

0107

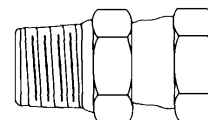

J&B #	HOSE FITTING PART #	PIPE THREAD	QTY
52932	0207-4-4	1/4	1
52934	0207-6-6	3/8	1
52936	0207-8-8	1/2	1
52938	0207-12-12	3/4	1
52940	0207-16-16	1	1
58176	0207-20-20	1-1/4	1-1/4

FEMALE PIPE ADAPTER

0207

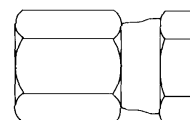

ADAPTERS

FEMALE PIPE SWIVEL

J&B #	PARKER #	T1 PORT THREAD	T2 FEMALE PIPE THREAD	QTY
^ 52365	0507-4-4	7/16	1/4	1
^ 52367	0507-6-4	9/16	1/4	1
52374	0507-6-6	9/16	3/8	1
^ 52369	0507-8-6	3/4	3/8	1
^ 52373	0507-6-8	9/16	1/2	1
52376	0507-8-8	3/4	1/2	1
^ 52375	0507-10-8	7/8	1/2	1
^ 52391	0507-12-12	1-1/16	3/4	1

STRAIGHT THREAD ADAPTER

0507

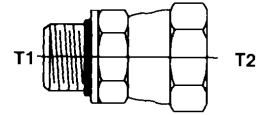

J&B #	HOSE FITTING PART #	MALE PIPE	FEMALE PIPE	QTY
51414	2107-2-2	1/8	1/8	1
52942	2107-4-4	1/4	1/4	1
52943	2107-6-4	3/8	1/4	1
52945	2107-4-6	1/4	3/8	1
52944	2107-6-6	3/8	3/8	1
52947	2107-8-6	1/2	3/8	1
52949	2107-6-8	3/8	1/2	1
52946	2107-8-8	1/2	1/2	1
52951	2107-8-12	1/2	3/4	1
52948	2107-12-12	3/4	3/4	1
52950	2107-16-16	1	1	1
51415	2107-20-20	1-1/4	1-1/4	1

MALE PIPE 90° ELBOW

2107

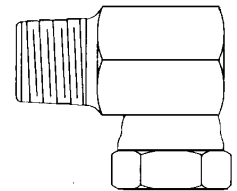

J&B #	HOSE FITTING PART #	FEMALE PIPE	QTY
56180	2207-4-4	1/4	1
56182	2207-6-6	3/8	1
56184	2207-8-8	1/2	1
56186	2207-12-12	3/4	1

FEMALE PIPE 90° ELBOW

2207

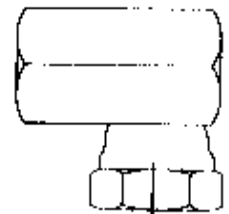

ADAPTERS

FEMALE PIPE SWIVEL

J&B #	HOSE FITTING PART #	MALE PIPE	FEMALE PIPE	QTY
52953	3107-2-2	1/8	1/8	1
52952	3107-4-4	1/4	1/4	1
52954	3107-6-6	3/8	3/8	1
52956	3107-6-8	3/8	1/2	1
52955	3107-8-8	1/2	1/2	1
52957	3107-12-12	3/4	3/4	1
52959	3107-16-16	1	1	1
52565	3107-20-20	1-1/4	1-1/4	1

**MALE PIPE
45° ELBOW**

3107

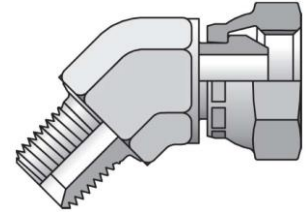

STRAIGHT THREAD

90° ELBOW

2507

J&B #	HOSE FITTING PART #	SAE STRAIGHT THREAD WITH O-RING	FEMALE PIPE	QTY
56160	2507-4-4	7/16	1/4	1
56162	2507-6-6	9/16	3/8	1
56164	2507-8-6	3/4	3/8	1
56166	2507-8-8	3/4	1/2	1
56168	2507-10-8	7/8	1/2	1
56170	2507-12-8	1-1/16	1/2	1
56172	2507-12-12	1-1/16	3/4	1



ADAPTERS

SEAL LOK FITTINGS

J&B #	HOSE FITTING PART #	END SIZE (1) & (2)	TUBE END (1)	TUBE END (2)	QTY
55460	4 XHLO-S	1/4	7/16-20	9/16-18	1
55462	6 XHLO-S	3/8	9/16-18	11/16-16	1
55467	8 XHLO-S	1/2	3/4-16	13/16-16	1
55465	10 XHLO-S	5/8	7/8-14	1-14	1
55466	12 XHLO-S	3/4	1-1/16-12	1-3/16-12	1
55468	16 XHLO-S	1	1-5/16-12	1-7/16-12	1

ORFS MALE END ADAPTER (XHLO-S)

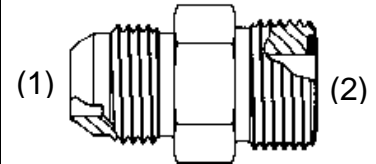

ORFS TUBE END REDUCER (TRLON-S)

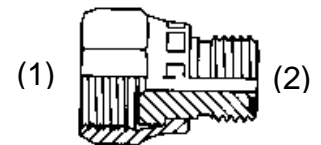

J&B #	HOSE FITTING PART #	END SIZE (1)	FEMALE END (1)	END SIZE (2)	MALE END (2)		QTY
*55464	6-4 TRLON-S	3/8	11/16-16	1/4	9/16-18		1
55470	10-8 TRLON-S	5/8	1-14	1/2	13/16-16	2 pieces	1
55472	12-8 TRLON-S	3/4	1-3/16-12	1/2	13/16-16	2 pieces	1
*55474	12-10 TRLON-S	3/4	1-3/16-12	5/8	1-14		1
*55476	20-16 TRLON-S	1-1/4	1-11/16-12	1"	1-7/16-12		1

* These sizes come manufactured with a crimp style nut on the large end.

ADAPTERS

SEAL LOK FITTINGS

J&B #	PARKER #	END SIZE (1) & (2)	JIC TUBE END (1)	ORFS END (2)	QTY
52542	4 LOHX6-S	1/4	7/16-20	9/16-18	1
52543	6 LOHX6-S	3/8	9/16-18	11/16-16	1
52544	8 LOHX6-S	1/2	3/4-16	13/16-16	1
52545	10 LOHX6-S	5/8	7/8-14	1-14	1
52546	12 LOHX6-S	3/4	1-1/16-12	1-3/16-12	1
52547	16 LOHX6-S	1	1-5/16-12	1-7/16-12	1

**SWIVEL ADAPTER
JIC TUBE SWIVEL /
ORFS
(LOHX6-S)**

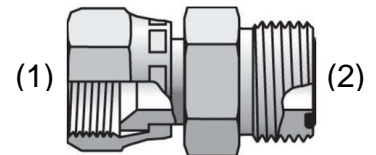

J&B #	PARKER #	END SIZE (1) & (2)	JIC TUBE END (1)	ORFS END (2)	QTY
52554	4 XHL6-S	1/4	7/16-20	9/16-18	1
52555	6 XHL6-S	3/8	9/16-18	11/16-16	1
52556	8 XHL6-S	1/2	3/4-16	13/16-16	1
52557	10 XHL6-S	5/8	7/8-14	1-14	1
52558	12 XHL6-S	3/4	1-1/16-12	1-3/16-12	1
52559	16 XHL6-S	1	1-5/16-12	1-7/16-12	1

**MALE SWIVEL
ADAPTER
JIC TUBE /
ORFS SWIVEL
(XHL6-S)**

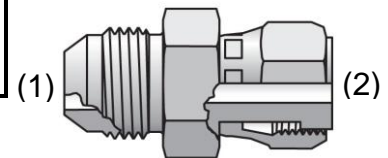

J&B #	PARKER #	ORFS END (1)	ORFS END (1)	PIPE THREAD (2)	QTY
54621	4 F6L	1/4	9/16-18	1/8	1
54622	4-4 F6L	1/4	9/16-18	1/4	1
54623	6 F6L	3/8	11/16-16	1/4	1
54624	6-6 F6L	3/8	11/16-16	3/8	1
54625	8 F6L	1/2	13/16-16	3/8	1
54626	8-8 F6L	1/2	13/16-16	1/2	1

**PIPE THREAD
SWIVEL CONN
ORFS SWIVEL /
NPTF
(F6L)**

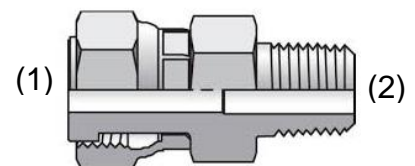

ADAPTERS

SEAL LOK FITTINGS

J&B #	PARKER #	O-RING BOSS (1)	ORFS END (2)	ORFS THREAD (2)	QTY
58100	4 F5OLO	7/16-20	1/4	9/16-18	1
58102	4-6 F5OLO	9/16-18	1/4	9/16-18	1
58104	6-4 F5OLO	7/16-20	3/8	11/16-16	1
58105	6 F5OLO	9/16-18	3/8	11/16-16	1
57444	6-8 F5OLO	3/4-16	3/8	11/16-16	1
58111	6-12 F5OLO	1-1/16-12	3/8	11/16-16	1
58110	8 F5OLO	3/4-16	1/2	13/16-16	1
57445	8-4 F5OLO	7/16-20	1/2	13/16-16	1
57446	8-6 F5OLO	9/16-18	1/2	13/16-16	1
57447	8-10 F5OLO	7/8-14	1/2	13/16-16	1
57448	8-12 F5OLO	1-1/16-12	1/2	13/16-16	1
57449	10 F5OLO	7/8-14	5/8	1-14	1
57450	12-8 F5OLO	3/4-16	3/4	1-3/16-12	1
57451	12-10 F5OLO	7/8-14	3/4	1-3/16-12	1
57452	12 F5OLO	1-1/16-12	3/4	1-3/16-12	1
57453	12-16 F5OLO	1-5/16-12	3/4	1-3/16-12	1
57454	16 F5OLO	1-5/16-12	1	1-7/16-12	1

STRAIGHT THREAD CONNECTOR ORB / ORFS (F5OLO)

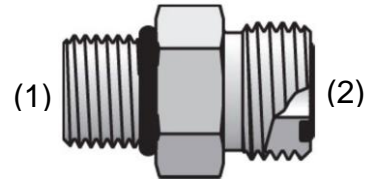

J&B #	PARKER #	O-RING BOSS (1)	ORFS END (2)	ORFS THREAD (2)	QTY
58120	4 C5OLO	7/16-20	1/4	9/16-18	1
58123	6 C5OLO	9/16-18	3/8	11/16-16	1
58126	8 C5OLO	3/4-16	1/2	13/16-16	1
57455	10 C5OLO	7/8-14	5/8	1-14	1
57456	12 C5OLO	1-1/16-12	3/4	1-3/16-12	1
57457	16 C5OLO	1-5/16-12	1	1-7/16-12	1

STRAIGHT THREAD ELBOW ORB / ORFS (C5OLO)

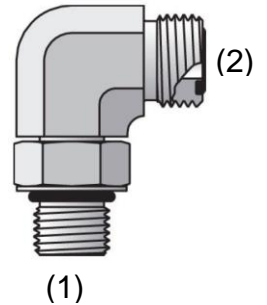

J&B #	PARKER #	O-RING BOSS (1)	ORFS END (2)	ORFS THREAD (2)	QTY
58178	6 F65OL	9/16-18	3/8	11/16-16	1
58179	8 F65OL	3/4-16	1/2	13/16-16	1
58181	12 F65OL	1-1/16-12	3/4	1-3/16-12	1
58182	16 F65OL	1-5/16-12	1"	1-7/16-12	1

STRAIGHT THREAD SWIVEL CONNECTOR ORB / ORFS (F65OL)

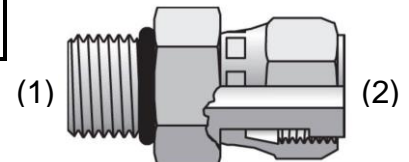

ADAPTERS

SEAL LOK FITTINGS

J&B #	PARKER #	ORFS END (1)	ORFS END (1)	PIPE THREAD (2)	QTY
57459	4 FLO	1/4	9/16-18	1/8	1
57460	4-4 FLO	1/4	9/16-18	1/4	1
57461	4-6 FLO	1/4	9/16-18	3/8	1
57462	6 FLO	3/8	11/16-16	1/4	1
57463	6-6 FLO	3/8	11/16-16	3/8	1
57464	6-8 FLO	3/8	11/16-16	1/2	1
57465	8 FLO	1/2	13/16-16	3/8	1
57466	8-8 FLO	1/2	13/16-16	1/2	1
57467	8-12 FLO	1/2	13/16-16	3/4	1
57468	10 FLO	5/8	1-14	1/2	1
57469	12 FLO	3/4	1-3/16-12	3/4	1
57470	12-16 FLO	3/4	1-3/16-12	1	1
57471	16-12 FLO	1	1-7/16-12	3/4	1
57472	16 FLO	1	1-7/16-12	1	1

**MALE PIPE
CONNECTOR
ORFS /
NPTF
(FLO-S)**

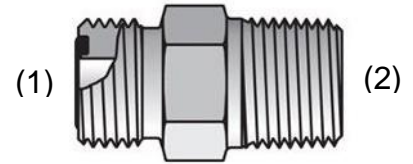

ADAPTERS

CAPS & PLUGS FOR SEAL LOK FITTINGS

Plugs for Seal Loks

J&B #	HOSE FITTING PART #	TUBE SIZE	QTY
^ 54275	4 PNLO-S	1/4	1
^ 54276	6 PNLO-S	3/8	1
^ 54277	8 PNLO-S	1/2	1
^ 54278	10 PNLO-S	5/8	1
^ 54279	12 PNLO-S	3/4	1
^ 54280	16 PNLO-S	1	1
54281	20 PNLO-S	1-1/4	1

ORFS TUBE END PLUG

PNLO-S

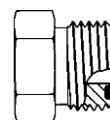

Caps for Seal Loks

J&B #	HOSE FITTING PART #	TUBE SIZE	QTY
^ 54265	4 FNL-S	1/4	1
^ 54266	6 FNL-S	3/8	1
^ 54267	8 FNL-S	1/2	1
^ 54268	10 FNL-S	5/8	1
^ 54269	12 FNL-S	3/4	1
^ 54270	16 FNL-S	1	1
^ 54271	20 FNL-S	1-1/4	1

ORFS TUBE END CAP

FNL-S

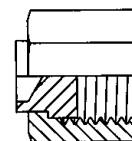

* Numbers with a “^” are not necessarily stocked in large quantities

ORFS O-RING 90 Durometer Nitrile

J&B #	PARKER #	DASH SIZE	END SIZE	WIDTH	I.D.	QTY
56230	2-011 N0552	-4	1/4	0.07	0.30	1
56231	2-012 N0552	-6	3/8	0.07	0.36	1
56232	2-014 N0552	-8	1/2	0.07	0.49	1
56233	2-016 N0552	-10	5/8	0.07	0.61	1
56234	2-018 N0552	-12	3/4	0.07	0.74	1
56235	2-020 N0552	-14	7/8	0.07	0.86	1
56236	2-021 N0552	-16	1	0.07	0.93	1
56237	2-025 N0552	-20	1-1/4	0.07	1.18	1
56238	2-029 N0552	-24	1-1/2	0.07	1.49	1

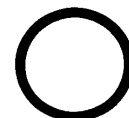

FERULOK FITTINGS

J&B #	PARKER #	TUBE O.D.	THREAD	QTY
55770	3 BU-S	3/16	3/8-24	1
55771	4 BU-S	1/4	7/16-20	1
55773	6 BU-S	3/8	9/16-18	1
55774	8 BU-S	1/2	3/4-16	1

**NUT
(BU)**



J&B #	PARKER #	TUBE O.D.	QTY
55780	3 TU-S	3/16	1
55781	4 TU-S	1/4	1
55783	6 TU-S	3/8	1
55784	8 TU-S	1/2	1

**FERRULE
(TU)**



J&B #	PARKER #	TUBE O.D.	TUBE ENDS	QTY
55790	3 HBU-S	3/16	3/8-24	1
55792	4 HBU-S	1/4	7/16-20	1
55794	6 HBU-S	3/8	9/16-18	1
55796	8 HBU-S	1/2	3/4-16	1

**UNION
(HBU)**



* 1200 PSI Working Pressure

J&B #	PARKER #	JIC TUBE SIZE (2)	FERULOK TUBE END (1)	QTY
56516	4 XHBU-S	1/4	7/16-20	1
56517	6 XHBU-S	3/8	9/16-18	1
56518	8 XHBU-S	1/2	3/4-16	1
56519	10 XHBU-S	5/8	7/8-14	1

**UNION ADAPTER
SAE FLARELESS /
37° FLARE**



J&B #	PARKER #	TUBE O.D.	FERULOK TUBE END (1)	PIPE THREAD (2)	QTY
52617	3 FBU-S	3/16	3/8-24	1/8	1
52618	4 FBU-S	1/4	7/16-20	1/8	1
52619	4-4 FBU-S	1/4	7/16-20	1/4	1
52623	6 FBU-S	3/8	9/16-18	1/4	1
52625	6-6 FBU-S	3/8	9/16-18	3/8	1
52627	8 FBU-S	1/2	3/4-16	3/8	1
52629	8-8 FBU-S	1/2	3/4-16	1/2	1

**MALE
CONNECTOR
(FU)**



Hydraulic Quick Couplers

FEM Series (Steel)

- Flush, non-spilling valving. Blow-out resistant seal.
- Coupler & nipple bodies have a modular design with increased flexibility for end port options.
- Protective zinc plating with clear trivalent chromate finish.
- Global interchangeability with other ISO 16028 compliant fittings.

J&B #	BODY SIZE	PORT THREAD	PARKER #	QTY
58140	1/4	1/4-18 NPSF	FEM-251-4FP-NL	1
58143	3/8	3/4-16 UNF	FEM-371-8FO	1
58144	1/2	1/2-14 NPSF	FEM-501-8FP	1
58146	1/2	7/8-14 UNF	FEM-501-10FO	1
58147	1/2	1-1/16-12 UNF	FEM-501-12FO	1
58148	3/4	3/4-14 NPSF	FEM-751-12FP-NL	1

**FEMALE THREAD
COUPLER**



J&B #	BODY SIZE	PORT THREAD	PARKER #	QTY
58150	1/4	1/4-18 NPSF	FEM-252-4FP	1
58152	3/8	3/4-16 UNF	FEM-372-8FO	1
58153	1/2	1/2-14 NPSF	FEM-502-8FP	1
58154	1/2	7/8-14 UNF	FEM-502-10FO	1
58155	1/2	1-1/16-12 UN	FEM-502-12FO	1
58156	3/4	3/4-14 NPSF	FEM-752-12FP	1

**FEMALE THREAD
NIPPLE**



Hydraulic Quick Couplers

6100 Series

- Connect and disconnect under pressure.
- Use a threaded union connection.
- Have a connection indicator that shows when fully connected.
- Handles pressures up to 3000 psi.

J&B #	BODY SIZE	THREAD SIZE	PARKER #	QTY
^56095	3/4	3/4-14	6125-12	1
^ 56090	1"	1-11 1/2	6125-16	1
^ 56091	1-1/4	1-1/4-11 1/2	6125-20	1

WING NUT COUPLER

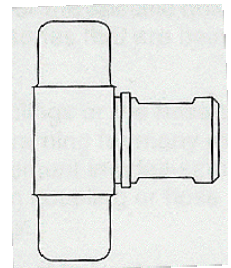

J&B #	BODY SIZE	PIPE THREAD	PARKER #	QTY
^56094	3/4	3/4-14	6105-12	1
^ 56092	1"	1-11 1/2	6105-16	1
^ 56093	1-1/4	1-1/4-11 1/2	6105-20	1

FEMALE THREAD NIPPLE

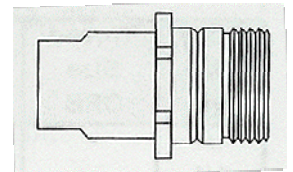

* Numbers with a “^” are not necessarily stocked in large quantities.

Hydraulic Quick Couplers

20 Series (Steel)

- Rated pressure 300 psi.
- Sleeve type couplers will interchange push-type couplers and other manufacturers' couplers which accept Industrial Interchange & nipples that conform to MIL-C4109.
- Temperature range is -40 F. to +250 F.
- Vacuum data 27.4Hg connected. Disconnected not recommended.

J&B #	BODY SIZE	PIPE THREAD	STEEL PARKER #	QTY
^ 55551	1/4	1/4-18	B23	1
^ 55555	3/8	3/8-18	B25	1
^ 55556	1/2	1/2-14	B17	1

FEMALE THREAD COUPLER

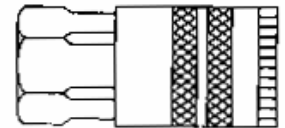

J&B #	BODY SIZE	PIPE THREAD	STEEL PARKER #	QTY
^ 55540	1/4	1/4-18	H3C	1
^ 55544	3/8	3/8-18	H3E	1

FEMALE THREAD NIPPLE

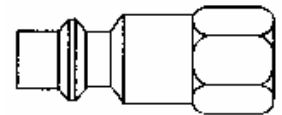

J&B #	BODY SIZE	PIPE THREAD	STEEL PARKER #	QTY
^ 55547	1/2	1/2-14	2F	1

MALE THREAD NIPPLE

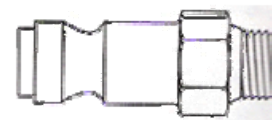

* Numbers with a “^” are not necessarily stocked in large quantities.

Hydraulic Quick Couplers

60 Series (Steel)

- Recommended where high cycle rates and pressure surges are encountered.
- “Industrial Interchange” design meets the dimensional requirements of Series B in ISO 7241-1.
- Temperature range is -40 F. to +250 F.
- Vacuum data 27.4Hg, both disconnected and connected

J&B #	BODY SIZE	PIPE THREAD	STEEL PARKER #	QTY
^ 55510	1/4	1/4-18	H2-62	1
^ 54618	3/8	3/8-18	H3-62	1
^ 55520	1/2	1/2-14	H4-62	1
^ 55530	3/4	3/4-14	H6-62	1
^ 55531	1”	1-11-1/2	H8-62	1

FEMALE THREAD COUPLER

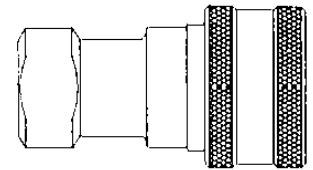

J&B #	BODY SIZE	PIPE THREAD	STEEL PARKER #	QTY
^ 55512	1/4	1/4-18	H2-63	1
^ 54620	3/8	3/8-18	H3-63	1
^ 55522	1/2	1/2-14	H4-63	1
^ 55533	3/4	3/4-14	H6-63	1
^55532	1”	1-11-1/2	H8-63	1

FEMALE THREAD NIPPLE

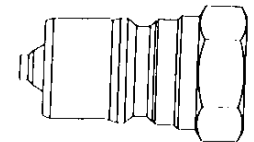

* Numbers with a “^” are not necessarily stocked in large quantities.

Hydraulic Quick Couplers

ADAPTERS

4000 Series (Steel)

- Plated to resist severe work and weather conditions.
- Metal to metal seal provides **positive shut-off**.
- Swivel action saves on hose twist wear.
- Interchangeable with most "Economy" type couplers.
- Temperature range -40 F. to +250 F.
- Rated pressure 3000 psi.

J&B #	BODY SIZE	THREAD SIZE	STEEL PARKER #	QTY
52691	1/4	1/4	4010-2	1
52687	3/8	3/8	4010-3	1
52689	1/2	1/2	8010-4	1

FEMALE THREAD NIPPLE

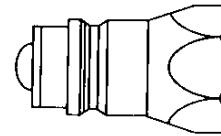

J&B #	BODY SIZE	THREAD SIZE	STEEL PARKER #	QTY
52690	1/4	1/4	4050-2	1
52686	3/8	3/8	4050-3	1
52688	1/2	1/2	4050-4	1

FEMALE THREAD COUPLER

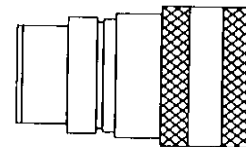

Hydraulic Quick Couplers

FF Series (Steel)

- Operating pressure is 3000 psi.
- The 3/8" size conforms to HTMA (Hydraulic Tool Manufacturers Association) standards.
- All sizes incorporate **flush face** mating surfaces.

J&B #	BODY SIZE	THREAD SIZE	PARKER PART #	QTY
54609	1/4	1/4-1/8 NPSF	FF-251-4FP	1
54610	3/8	3/8-18 NPSF	FF-371-6FP	1
54614	3/8	1/2-14 NPSF	FF-371-8FP	1
54611	1/2	1/2-14 NPSF	FF-501-8FP	1
54615	3/4	3/4-14 NPSF	FF-751-12FP	1

FF SERIES
COUPLER



* **CAUTION:** These products are not to be used as swivels. Rotation under pressure will result in excessive and premature wear.

J&B #	BODY SIZE	THREAD SIZE	PARKER PART #	QTY
54604	1/4	1/4-18 NPSF	FF-252-4FP	1
54612	3/8	3/8-18 NPSF	FF-372-6FP	1
54616	3/8	1/2-14 NPSF	FF-372-8FP	1
^ 54613	1/2	1/2-14 NPSF	FF-502-8FP	1
54617	3/4	3/4-1/4 NPSF	FF752-12FP	1

FF SERIES
NIPPLE



^ 54613 is a longer series.

* **CAUTION:** These products are not to be used as swivels. Rotation under pressure will result in excessive and premature wear.

HOSE ACCESSORIES

PARTEK SLEEVE

- Parker's Partek Nylon Protective Sleeving gives you Tough hose abrasion protection.
- The weave gives an exceptionally smooth interior wall, allowing rubber hose to move freely inside the sleeve, providing easy installation and prevents any internal abrasion problems.
- Per the ISO 6945 specification, Partek has a unique tubular weave nylon construction strong enough to withstand greater than 200,000 abrasion cycles without wearing the fabric at any location.
- Temperature Range: -67 deg F to + 248 deg F (-53 deg C to +120 deg C).
- Color is **BLACK**.



J&B #	INSIDE DIA. FLAT	INSIDE DIA. ROUND	SS25UL 201	285	302	426 351TC 451TC 471TC	772TC	782TC	811 881	PARKER #	QTY
50100	1.07"	0.69"	-4	-4		-3/-4				AS-B-11	50/FT
50101	1.34"	0.86"	-5/-6	-5/-6	-4/-5	-5/-6				AS-B-13	50/FT
50102	1.66"	1.06"	-8	-8/-10	-6	-8	-6			AS-B-15	50/FT
50103	1.92"	1.22"	-10	-12	-8/-10	-10	-8			AS-B-17	50/FT
50104	2.12"	1.35"	-12		-12	-12	-10	-8		AS-B-19	50/FT
50105	2.24"	1.42"	-16	-16			-12	-10	-12	AS-B-22	50/FT
50107	2.55"	1.63"				-16		-12		AS-B-27	50/FT

*** All sizes sold by the roll. Can break a roll and can be sold by the foot (must be in multiples of feet and cannot be broken down to inches).

HOSE ACCESSORIES

STRAIN RELIEVERS

- Resistant to chemicals, weather and abrasion
- Excellent for pressure washer hoses.
- Reduces cracking at hose/fitting connection.

***Strain relief fits over hose & fitting**

J&B #	SIZE	QTY
38901	3/8	1
38902	1/2	1



Strain relief

HOSE PROTECTORS

- Protects hose & wire abrasion caused by points of contact wear with frames or other abrasive surfaces.
- Material is very durable and has a high wear factor.
- Molded in grooves prevent the slipping and wear of cable ties.
- Easy to assemble and remove.
- Typically used on hydraulic hoses, fuel and oil lines, brake systems, wiring harnesses and battery cables.



***Cable ties not included.**

J&B #	COLOR	LENGTH	QTY
V21133	BLACK	4"	1
V21134	BLACK	6"	1
V21135	BLACK	8"	1

CAPPLUGS

SERIES T TAPERED CAPPLUGS

- Tapered caplugs can be used as either **caps** or **plugs**.
- Because they are tapered in design and made from highly flexible Polyethylene, they cannot only be applied to fit **snugly** but are readily **removable**...whether used for capping or plugging.
- Especially recommended for use on MIL Std. and SAE-type tube and hydraulic fittings and for threaded external and internal N.P.T. fittings.

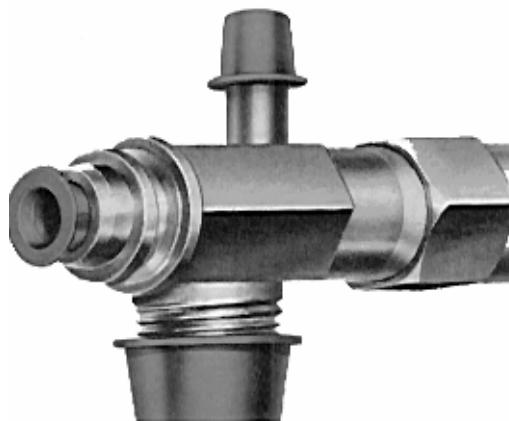
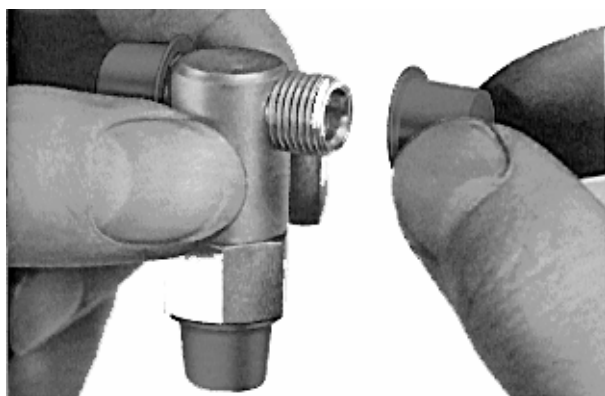

J&B #	CAPLUG #	QTY
41800	1	25
41801	2	25
41802	2-x	25
41803	3	25
41804	3-x	25
41805	4	25
41806	4-x	25
41807	5	25
41808	6	25
41809	6-x	25
41810	7	25
41811	8	25
41812	8-x	25
41813	9	25
41814	9-x	25
41815	10	25

J&B #	CAPLUG #	QTY
41816	11	25
41817	11-x	25
41818	12-x	10
41819	13	10
41820	13-x	10
41821	14	10
41822	14-x	10
41823	15-x	5
41824	16	5
41825	17	5
41826	17-s	5
41827	18	5
41828	19	5
41829	20	5
41830	20-s	5



Series T Tapered Caplugs

***Selection Charts are on page 797**

CAPPLUGS

SERIES T TAPERED CAPPLUGS

Selection Charts

Recommended closures for tube and hydraulic fittings

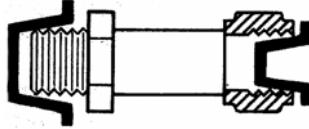

DASH #	TUBING O.D #	THREAD	CAPLUG # AS PLUGS	CAPLUG # AS CAPS
-2	1/8	5/16-24	1	2
-3	3/16	3/8-24	2	3-x
-4	1/4	7/16-20	3	4-x
-5	5/16	1/2-20	4	5
-6	3/8	9/16	5	6-x
-6	3/8	5/8-18	6	7
-8	1/2	3/4-16	8	9-x
-10	5/8	7/8-14	10	11-x
-12	3/4	1-1/16-12	12-x	13-x
-16	1	1-5/16-12	14-x	15-x
-20	1-1/4	1-5/8-12	17-s	18
-24	1-1/2	1-7/8-12	19	20

Recommended closures for threaded external and internal N.P.T. fittings

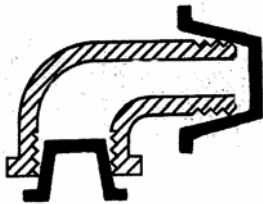

SIZE	CAPLUG # AS PLUGS	CAPLUG # AS CAPS
1/8	2-x	4
1/4	4	6
3/8	6-x	8-x
1/2	9	11
3/4	12-x	13-x
1	14	15-x
1-1/4	17-s	18
1-1/2	20-s	20

Recommended closures for unthreaded standard weight pipe

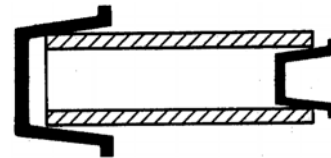

SIZE	CAPLUG # AS PLUGS	CAPLUG # AS CAPS
1/8	1	4
1/4	2-x	6-x
3/8	5	8-x
1/2	7	11
3/4	10	13-x
1	13	16
1-1/4	16	18-x
1-1/2	18	

HOSE

PRESSURE WASHER HOSE

- Each hose is pre-assembled with 50 feet of hose, a strain relief on each end, and a male pipe fitting on each end.
- Also available in custom lengths.



J&B #	HOSE I.D.	PIPE THREAD	MAXIMUM WORKING PRESSURE (PSI)	HOSE	QTY
38905	3/8	3/8	4,000	436	1 EA
38906	1/2	1/2	2,000	426	1 EA

O-RING ASSORTMENTS

PARKER O-RING KITS



J&B #	STYLE	QTY
54490	SAE STRAIGHT THREAD	EA

54490 SAE O-RING KIT Includes...

10 EA -2 (5/16-24)	10 EA -10 (7/8-14)
10 EA -3 (3/8-24)	15 EA -12 (1-1/16-12)
15 EA -4 (7/16-20)	10 EA -14 (1-3/16-12)
10 EA -5 (1/2-20)	15 EA -16 (1-5/16-12)
15 EA -6 (9/16-18)	10 EA -20 (1-5/8-12)
15 EA -8 (3/4-16)	10 EA -24 (1-7/8-12)

J&B #	STYLE	QTY
54492	SEAL LOK	EA

54492 SEAL LOK O-RING KIT Includes...

25 EA -4 (1/4'')	10 EA -12 (3/4'')
25 EA -6 (3/8'')	10 EA -16 (1'')
25 EA -8 (1/2'')	10 EA -20 (1-1/4'')
25 EA -10 (5/8'')	10 EA -24 (1-1/2'')

J&B #	STYLE	QTY
54494	CODE 61 & CODE62	EA

54494 CODE 61 & 62 O-RING KIT Includes...

10 EA -8 (1/2'')	15 EA -24 (1-1/2'')
10 EA -12 (3/4'')	8 EA -32 (2'')
15 EA -16 (1'')	6 EA -40 (2-1/2'')
15 EA -20 (1-1/4'')	6 EA -48 (3'')

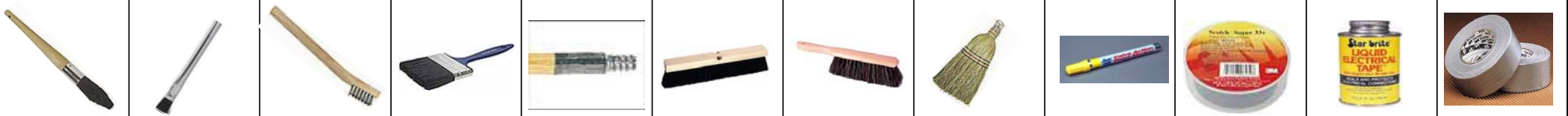

















J&B Fleet - Industrial Supply

22428 Harrisburg-Westville Rd. Alliance, Ohio 44601 Phone: (330) 821-6342 Fax: (330) 821-0411

www.jbfleet.com

PART # 2114

ADAPTERS SAE (JIC) 1/4 – 1/2

 54104 ¹ 1/4 PLUG ₃	 54106 ² 3/8 PLUG ₃	 54108 ³ 1/2 PLUG ₂	 54124 ⁴ 1/4 CAP ₃	 54126 ⁵ 3/8 CAP ₃	 54128 ⁶ 1/2 CAP ₂
 51406 ⁷ 1/2 UNION ₁	 52772 ⁹ 1/2 T X 3/8 P MALE CONNECTOR ₂	 51374 ¹⁰ 1/2 T X 1/2 P MALE CONNECTOR ₂	 51383 ¹¹ 1/2 T X 3/8 P 90 MALE CONNECTOR ₁	 51384 ¹² 1/2 T X 1/2 P 90 MALE CONNECTOR ₁	
 51404 ¹³ 3/8 UNION ₂	 52770 ¹⁵ 3/8 T X 1/4 P MALE CONNECTOR ₂	 51372 ¹⁶ 3/8 T X 3/8 P MALE CONNECTOR ₂	 51381 ¹⁷ 3/8 T X 1/4 P 90 MALE CONNECTOR ₂	 51382 ¹⁸ 3/8 T X 3/8 P 90 MALE CONNECTOR ₂	
 51402 ¹⁹ 1/4 UNION ₂	 52769 ²¹ 1/4 T X 1/8 P MALE CONNECTOR ₂	 51370 ²² 1/4 T X 1/4 P MALE CONNECTOR ₂	 51380 ²³ 1/4 T X 1/4 P 90 MALE CONNECTOR ₂	 	



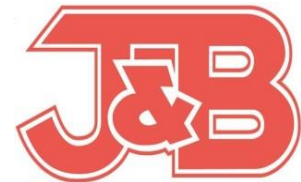



PART# 2834

J&B Fleet - Industrial Supply

22428 Harrisburg-Westville Rd. Alliance, Ohio 44601 Phone: (330) 821-6342 Fax: (330) 821-0411

www.jbfleet.com

FLAT FACE CAP & PLUG

<p>54275</p>  <p>1/4"</p> <p>2</p>	<p>54265</p>  <p>1</p>	<p>54278</p>  <p>5/8"</p> <p>2</p>	<p>54280</p>  <p>1"</p> <p>3</p>
<p>54276</p>  <p>3/8"</p> <p>2</p>	<p>54266</p>  <p>4</p>	<p>54268</p>  <p>5/8"</p> <p>2</p>	<p>54270</p>  <p>1"</p> <p>6</p>
<p>54277</p>  <p>1/2"</p> <p>1</p>	<p>54279</p>  <p>3/4"</p> <p>2</p>	<p>54281</p>  <p>1-1/4"</p> <p>2</p>	<p>54281</p>  <p>9</p>
<p>54267</p>  <p>1/2"</p> <p>2</p>	<p>54269</p>  <p>3/4"</p> <p>2</p>	<p>54271</p>  <p>1-1/4"</p> <p>1</p>	<p>54271</p>  <p>12</p>

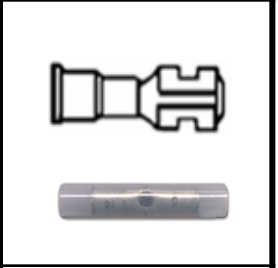

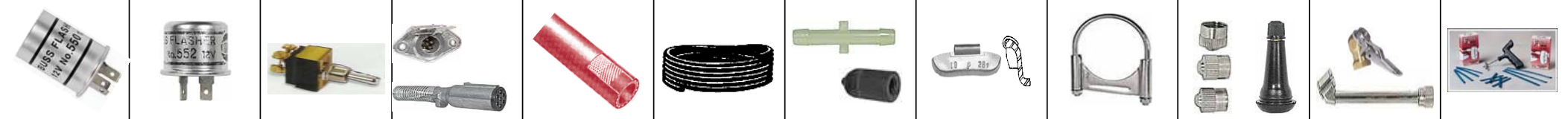















J&B Fleet - Industrial Supply

www.jbfleet.com

22428 Harrisburg-Westville Rd. Alliance, Ohio 44601 Phone: (330) 821-6342 Fax: (330) 821-0411

PART # 2110

ADAPTERS SAE (JIC) 5/8 – 1”

 52775 1 5/8 TUBE X 1/2 PIPE MALE CONNECTOR 2	 52778 2 3/4 TUBE X 1/2 PIPE MALE CONNECTOR 2	 51376 3 3/4 TUBE X 3/4 PIPE MALE CONNECTOR 1	 51378 4 1” TUBE X 1” PIPE MALE CONNECTOR 1
 51407 5 5/8 UNION 2	 51408 6 3/4 UNION 2	 51410 7 1” UNION 1	 51395 8 1” TUBE X 1 PIPE 90 MALE CONNECTOR 1
 54110 9 5/8 PLUG 2	 54112 10 3/4 PLUG 2	 54116 11 1” PLUG 2	 51386 12 3/4 TUBE X 3/4 PIPE 90 MALE CONNECTOR 1
 54130 13 5/8 CAP 2	 54132 14 3/4 CAP 2	 54133 15 1” CAP 2	16

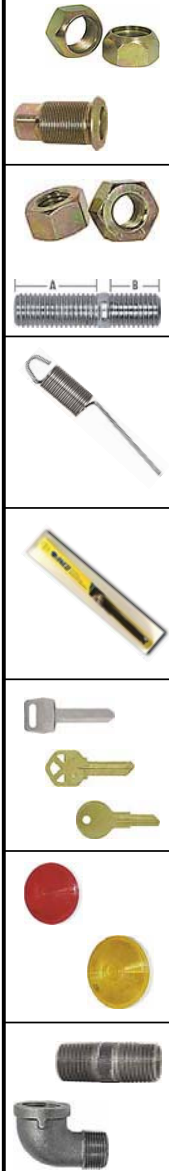

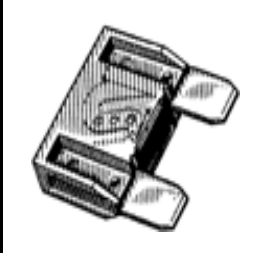









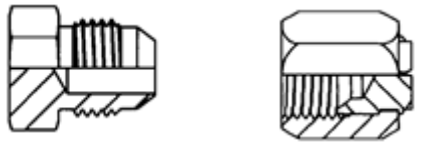

J&B Fleet - Industrial Supply

22428 Harrisburg-Westville Rd. Alliance, Ohio 44601 Phone: (330) 821-6342 Fax: (330) 821-0411

www.jbfleet.com

PART#2816

JIC PLUG & CAP

<p>54105 & 54125</p>  <p>#5 5/16" 37° FLARE PLUG & CAP</p> <p>2 2</p>	<p>54110 & 54130</p>  <p>#10 5/8" 37° FLARE PLUG & CAP</p> <p>2 2</p>	<p>54114 & 54131</p>  <p>#14 7/8" 37° FLARE PLUG & CAP</p> <p>2 2</p>	<p>54118 & 54135</p>  <p>#20 1-1/4" 37° FLARE PLUG & CAP</p> <p>2 2</p>
<p>54104 & 54124</p>  <p>#4 1/4" 37° FLARE PLUG & CAP</p> <p>2 2</p>	<p>54108 & 54128</p>  <p>#8 1/2" 37° FLARE PLUG & CAP</p> <p>2 2</p>	<p>54112 & 54132</p>  <p>#12 3/4" 37° FLARE PLUG & CAP</p> <p>2 2</p>	<p>54116 & 54133</p>  <p>#16 1" 37° FLARE PLUG & CAP</p> <p>2 2</p>
<p>54103 & 54123</p>  <p>#3 3/16" 37° FLARE PLUG & CAP</p> <p>2 2</p>	<p>54106 & 54126</p>  <p>#6 3/8" 37° FLARE PLUG & CAP</p> <p>2 2</p>		



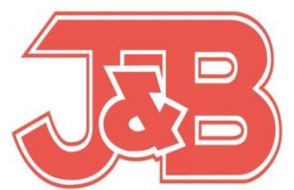
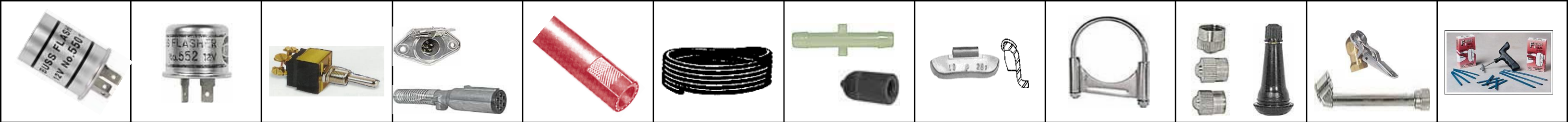









J&B Fleet - Industrial Supply

22428 Harrisburg-Westville Rd. Alliance, Ohio 44601 Phone: (330) 821-6342 Fax: (330) 821-0411

www.jbfleet.com

O-RING FACE SEAL O-RING 90 DUROMETER NITRILE

PART # 2810

<p>56230</p>  <p>-4 1/4" END SIZE</p> <p>10</p>	<p>56233</p>  <p>-10 5/8" END SIZE</p> <p>10</p>	<p>56236</p>  <p>-16 1" END SIZE</p> <p>5</p>	
<p>56231</p>  <p>-6 3/8" END SIZE</p> <p>10</p>	<p>56234</p>  <p>-12 3/4" END SIZE</p> <p>5</p>	<p>56237</p>  <p>-20 1-1/4" END SIZE</p> <p>5</p>	
<p>56232</p>  <p>-8 1/2" END SIZE</p> <p>10</p>	<p>56235</p>  <p>-14 7/8" END SIZE</p> <p>5</p>	<p>56238</p>  <p>-24 1-1/2" END SIZE</p> <p>5</p>	



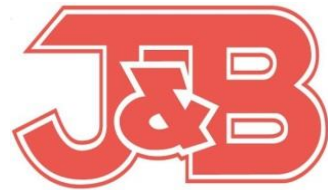
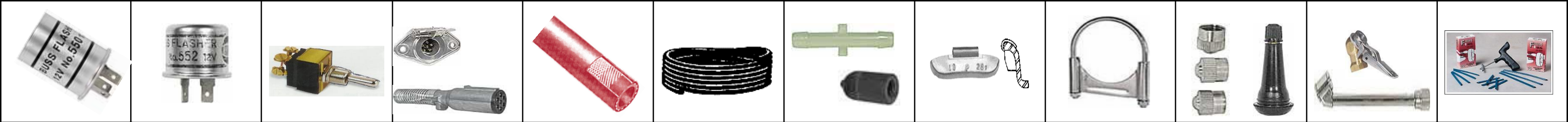









J&B Fleet - Industrial Supply

22428 Harrisburg-Westville Rd. Alliance, Ohio 44601 Phone: (330) 821-6342 Fax: (330) 821-0411

www.jbfleet.com

**SAE STRAIGHT THREAD PORT O-RINGS
90 DUROMETER NITRILE**

PART # 2811

<p>56260</p>  <p>-4 1/4" END SIZE</p> <p>20</p>	<p>56266</p>  <p>-8 1/2" END SIZE</p> <p>15</p>	<p>56272</p>  <p>-16 1" END SIZE</p> <p>10</p>	
<p>56262</p>  <p>-5 5/16" END SIZE</p> <p>20</p>	<p>56268</p>  <p>-10 5/8" END SIZE</p> <p>10</p>	<p>56274</p>  <p>-20 1-1/4" END SIZE</p> <p>5</p>	
<p>56264</p>  <p>-6 3/8" END SIZE</p> <p>20</p>	<p>56270</p>  <p>-12 3/4" END SIZE</p> <p>10</p>		

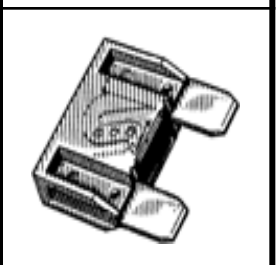









LET US HELP YOU MAKE THE CONNECTION



J & B FLEET-INDUSTRIAL SUPPLY
PHONE: 330-821-6342

PART#3107

**SAE STRAIGHT THREAD PORT O-RINGS
90 DUROMETER NITRILE**

<p>56260</p>  <p>-4 1/4" END SIZE</p> <p>12</p>	<p>56262</p>  <p>-5 5/16" END SIZE</p> <p>12</p>	<p>56264</p>  <p>-6 3/8" END SIZE</p> <p>12</p>	<p>56266</p>  <p>-8 1/2" END SIZE</p> <p>12</p>	<p>56268</p>  <p>-10 5/8" END SIZE</p> <p>12</p>	<p>56270</p>  <p>-12 3/4" END SIZE</p> <p>12</p>
<p>56272</p>  <p>-16 1" END SIZE</p> <p>12</p>		<p>56274</p>  <p>-20 1-1/4" END SIZE</p> <p>12</p>			

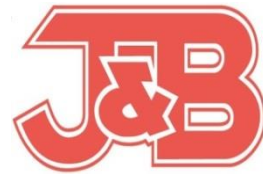
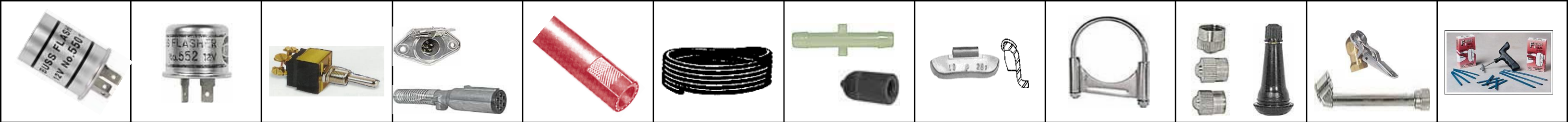



J&B Fleet - Industrial Supply

www.jbfleet.com

22428 Harrisburg-Westville Rd. Alliance, Ohio 44601 Phone: (330) 821-6342 Fax: (330) 821-0411

PART# 2815

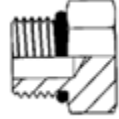
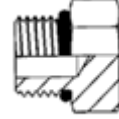
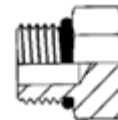
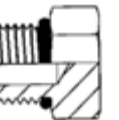
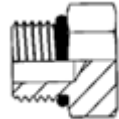
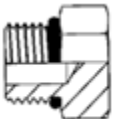
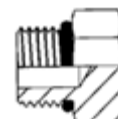
HEX O-RING PLUG

<p>54642</p>  <p>#4 7/16-20 HEX O-RING PLUG</p> <p>4</p>	<p>54645</p>  <p>#8 3/4-16 HEX O-RING PLUG</p> <p>4</p>	<p>54647</p>  <p>#12 1-1/16-12 HEX O-RING PLUG</p> <p>4</p>	
<p>54641</p>  <p>#3 3/8-24 HEX O-RING PLUG</p> <p>4</p>	<p>54644</p>  <p>#6 9/16-18 HEX O-RING PLUG</p> <p>4</p>	<p>54646</p>  <p>#10 7/8-14 HEX O-RING PLUG</p> <p>4</p>	<p>54648</p>  <p>#16 1-5/16-12 HEX O-RING PLUG</p> <p>2</p>
<p>54640</p>  <p>#2 5/16-24 HEX O-RING PLUG</p> <p>4</p>	<p>54643</p>  <p>#5 1/2-20 HEX O-RING PLUG</p> <p>4</p>		

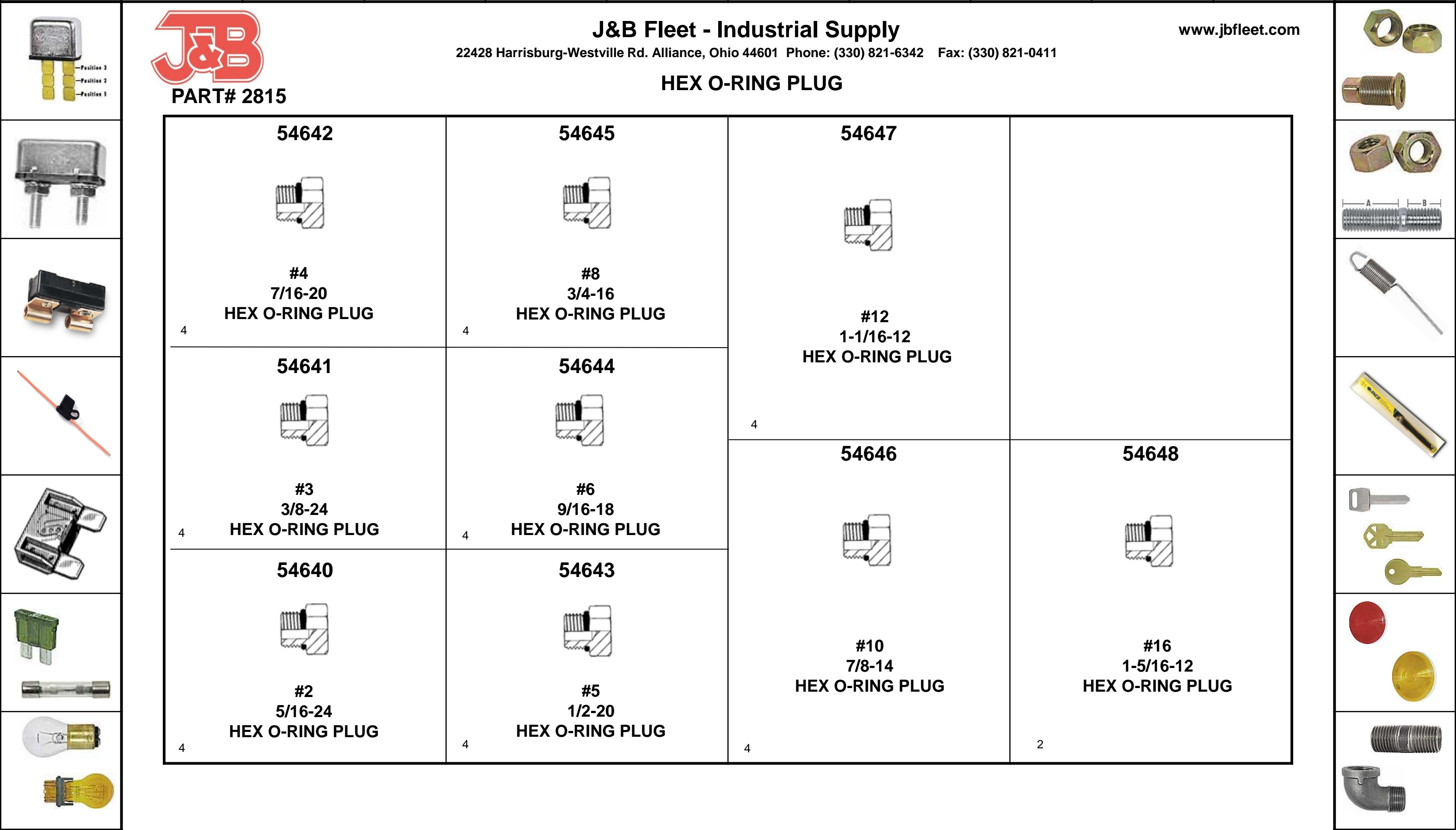



J&B Fleet - Industrial Supply





22428 Harrisburg-Westville Rd. Alliance, Ohio 44601 Phone: (330) 821-6342 Fax: (330) 821-0411

www.jbfleet.com

PART # 2116

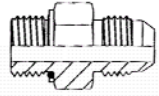
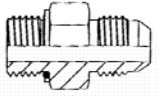
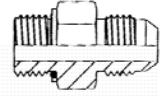
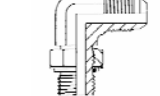
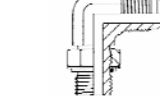
METRIC HYDRAULIC ADAPTERS

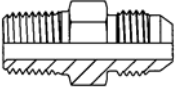
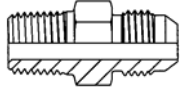
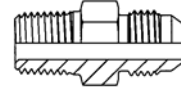
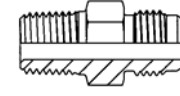
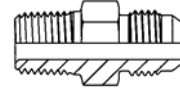
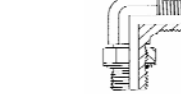
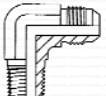
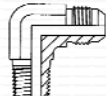
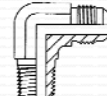
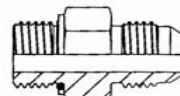
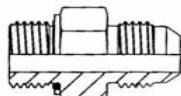
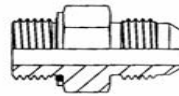
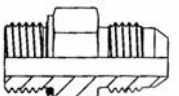
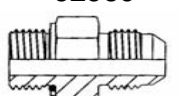
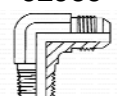

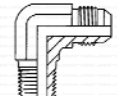
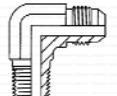
<p>53010 ¹</p>  <p>1/4 TUBE OD M10 X 1 STRAIGHT</p> <p>¹</p>	<p>53012 ²</p>  <p>3/8 TUBE OD M14 X 1.5 STRAIGHT</p> <p>¹</p>	<p>53013 ³</p>  <p>1/2 TUBE OD M16 X 1.5 STRAIGHT</p> <p>¹</p>	<p>53020 ⁴</p>  <p>1/4 TUBE OD M10 X 1 STRAIGHT</p> <p>¹</p>	<p>53022 ⁵</p>  <p>3/8 TUBE OD M14 X 1.5 STRAIGHT</p> <p>¹</p>	<p>53023 ⁶</p>  <p>1/2 TUBE OD M16 X 1.5 STRAIGHT</p> <p>¹</p>
<p>53040 ⁷</p>  <p>1/4 TUBE OD 1/8 BSPT PIPE</p> <p>¹</p>	<p>53041 ⁸</p>  <p>1/4 TUBE OD 1/4 BSPT PIPE</p> <p>¹</p>	<p>53044 ⁹</p>  <p>3/8 TUBE OD 1/4 BSPT PIPE</p> <p>¹</p>	<p>53045 ¹⁰</p>  <p>3/8 TUBE OD 3/8 BSPT PIPE</p> <p>¹</p>	<p>53049 ¹¹</p>  <p>1/2 TUBE OD 1/2 BSPT PIPE</p> <p>¹</p>	<p>53060 ¹²</p>  <p>1/4 TUBE OD 1/4 BSPT PIPE</p> <p>¹</p>
<p>53063 ¹³</p>  <p>3/8 TUBE OD 1/4 BSPT PIPE</p> <p>¹</p>	<p>53064 ¹⁴</p>  <p>3/8 TUBE OD 3/8 BSPT PIPE</p> <p>¹</p>	<p>53068 ¹⁵</p>  <p>1/2 TUBE OD 1/2 BSPT PIPE</p> <p>¹</p>	<p>52970 ¹⁶</p>  <p>1/4 TUBE OD 1/8 BSPP PIPE</p> <p>¹</p>	<p>52971 ¹⁷</p>  <p>1/4 TUBE OD 1/4 BSPP PIPE</p> <p>¹</p>	<p>52976 ¹⁸</p>  <p>3/8 TUBE OD 1/4 BSPP PIPE</p> <p>¹</p>
<p>52977 ¹⁹</p>  <p>3/8 TUBE OD 3/8 BSPP PIPE</p> <p>¹</p>	<p>52980 ²⁰</p>  <p>1/2 TUBE OD 1/2 BSPP PIPE</p> <p>¹</p>	<p>52985 ²¹</p>  <p>1/4 TUBE OD 1/4 BSPP PIPE</p> <p>¹</p>	<p>52987 ²²</p>  <p>3/8 TUBE OD 1/4 BSPP PIPE</p> <p>¹</p>	<p>52988 ²³</p>  <p>3/8 TUBE OD 3/8 BSPP PIPE</p> <p>¹</p>	<p>52991 ²⁴</p>  <p>1/2 TUBE OD 1/2 BSPP PIPE</p> <p>¹</p>



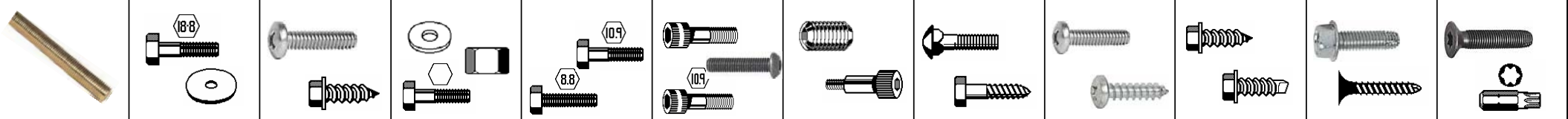

J&B Fleet - Industrial Supply

22428 Harrisburg-Westville Rd. Alliance, Ohio 44601 Phone: (330) 821-6342 Fax: (330) 821-0411

www.jbfleet.com

PART # 2117

METRIC HYDRAULIC ADAPTERS

<p>53010 1</p> <p>1/4 TUBE OD M10 X 1 STRAIGHT</p> <p>1</p>	<p>53012 2</p> <p>3/8 TUBE OD M14 X 1.5 STRAIGHT</p> <p>1</p>				
<p>7</p>	<p>53041 8</p> <p>1/4 TUBE OD 1/4 BSPT PIPE</p> <p>1</p>	<p>9</p>	<p>53045 10</p> <p>3/8 TUBE OD 3/8 BSPT PIPE</p> <p>1</p>	<p>11</p>	<p>53060 12</p> <p>1/4 TUBE OD 1/4 BSPT PIPE</p> <p>1</p>
<p>13</p>	<p>53064 14</p> <p>3/8 TUBE OD 3/8 BSPT PIPE</p> <p>1</p>	<p>15</p>	<p>16</p>	<p>52971 17</p> <p>1/4 TUBE OD 1/4 BSP9 PIPE</p> <p>1</p>	<p>18</p>
<p>52977 19</p> <p>3/8 TUBE OD 3/8 BSPP PIPE</p> <p>1</p>	<p>20</p>	<p>21</p>	<p>22</p>	<p>23</p>	<p>24</p>

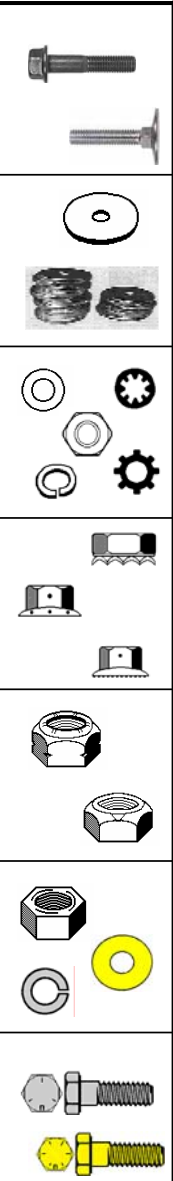

LET US HELP YOU MAKE THE CONNECTION

PART# 3108



**90 Durometer
Nitrile**

O-RING FACE SEAL



J & B FLEET-INDUSTRIAL SUPPLY
PHONE: 330-821-6342

56230 -4 2-011 25	56231 -6 2-012 25	56232 -8 2-014 25	56233 -10 2-016 25	56234 -12 2-018 25	56235 -14 2-020 10
56236 -16 2-021 10	56237 -20 2-025 10	56238 -24 2-029 10			



J&B Fleet - Industrial Supply

22428 Harrisburg-Westville Rd. Alliance, Ohio 44601 Phone: (330) 821-6342 Fax: (330) 821-0411

www.jbfleet.com

PART # 2121

CAP PLUGS



<p>41800 ¹</p> <p>#1</p> <p>10</p>	<p>41801 ²</p> <p>#2</p> <p>10</p>	<p>41802 ³</p> <p>#2-X</p> <p>10</p>	<p>41803 ⁴</p> <p>#3</p> <p>10</p>	<p>41804 ⁵</p> <p>#3-X</p> <p>10</p>	<p>41805 ⁶</p> <p>#4</p> <p>10</p>	<p>41806 ⁷</p> <p>#4-X</p> <p>10</p>	<p>41807 ⁸</p> <p>#5</p> <p>10</p>
<p>41808 ⁹</p> <p>#6</p> <p>10</p>	<p>41809 ¹⁰</p> <p>#6-X</p> <p>10</p>	<p>41810 ¹¹</p> <p>#7</p> <p>10</p>	<p>41811 ¹²</p> <p>#8</p> <p>10</p>	<p>41812 ¹³</p> <p>#8-X</p> <p>10</p>	<p>41813 ¹⁴</p> <p>#9</p> <p>10</p>	<p>41814 ¹⁵</p> <p>#9-X</p> <p>10</p>	<p>41815 ¹⁶</p> <p>#10</p> <p>10</p>
<p>41816 ¹⁷</p> <p>#11</p> <p>10</p>	<p>41817 ¹⁸</p> <p>#11-X</p> <p>10</p>	<p>41818 ¹⁹</p> <p>#12-X</p> <p>5</p>	<p>41819 ²⁰</p> <p>#13</p> <p>5</p>	<p>41820 ²¹</p> <p>#13-X</p> <p>5</p>	<p>41821 ²²</p> <p>#14</p> <p>5</p>	<p>41822 ²³</p> <p>#14-X</p> <p>5</p>	<p>41823 ²⁴</p> <p>#15-X</p> <p>2</p>
<p>41824 ²⁵</p> <p>#16</p> <p>2</p>	<p>41825 ²⁶</p> <p>#17</p> <p>2</p>	<p>41826 ²⁷</p> <p>#17-S</p> <p>2</p>	<p>41827 ²⁸</p> <p>#18</p> <p>2</p>	<p>41828 ²⁹</p> <p>#19</p> <p>2</p>	<p>41829 ³⁰</p> <p>#20</p> <p>2</p>	<p>41830 ³¹</p> <p>#20-S</p> <p>2</p>	<p>41830 ³²</p>

