

details

Moulding Collection

Southern Edition



EL & EL Wood Products

Millwork that creates distinction.™

Bodyguard

MDF

Hardwoods

Pine

Redwood

Fir



details

EL & EL Wood Products
Moulding Collection
Southern Edition

4	Green Practices
5	Green Building
6	Product Information & Symbols
7	About Mouldings
9	Solid Pine
31	Raw & Primed FJ Pine
61	Hardwoods
119	Ultralight MDF & LDF
175	VG Doug Fir & Redwood
193	Bodyguard & Protected Trimboard



COMMITMENT

EL & EL is dedicated to making a positive environmental impact every day by realizing how vitally important it is to conserve our environment. Within our facilities we recycle cardboard, wood pallets, fluorescent light bulbs, plastic strapping, metal strapping, plastic bags, glass and plastic bottles, aluminum cans, and paper. We installed new technology lighting that reduced our kilowatt usage by 30%. We will continue our commitment to improving our world through new technologies and advancements and seek out improvements in the area of gas and petroleum usage. Our commitment is for a better world and a better life for all. We support those manufacturers and companies that practice sustainable forest management and integrate the world's economic and environmental needs. The following principles help to guide us in our actions and lead us down a path of sustainability.

FOREST MANAGEMENT

We believe in and endorse sustainable forestry principles which integrate the perpetual reforestation, growing and harvesting of trees with the protection of wildlife, plants, soil, air, and water quality.

ENVIRONMENTAL MANAGEMENT

We encourage sound environmental management practices of forests, processes and recycling to ensure that building materials are available to assist in providing better quality of life for future generations. We encourage manufacturers to embrace independent third party verification of forest practices or to strictly abide by requirements of certification ideals.

CERTIFICATION PROGRAMS & STANDARDS

We support and endorse the significant efforts being made within the forest products industry to satisfy the public's environmental concerns through scientifically based certification programs. However, we do not promote or endorse one certification program over another because no single system or policy is applicable or geographically available to all situations.

PRODUCTS

We promote companies that keep the vision of the environment as one of their primary focuses and that are committed to sustainable forestry practices. Products distributed from these facilities have been harvested from forests that meet stringent environmental, social and economic standards.

We support the protection and preservation of our natural resources. By acquiring our FSC Chain of Custody Certification, we are doing our part to ensure that our natural resources will be protected for future generations. We endorse the significant efforts being made to satisfy the public's environmental concerns, that are recognized as environmental standards, in all parts of the world through scientifically based certification programs such as FSC, SFI, CERTFOR and PEFC.

WHAT IS GREEN BUILDING?

Green building can be defined as a set of guiding principles, somewhat like a guardrail on a mountain road, to assist the building and design communities on the path to sustainability. Green built homes have improved energy efficiency, conserve water and other natural resources, lends themselves to improved indoor air quality, reduce pollution, are less dependent on fossil fuels, are more durable and more comfortable than homes built previously. The term green building is often interchanged with sustainable, high-performance or healthy.

THE "FIVE PILLARS" OF GREEN BUILDING

- Refers to an integrated approach to residential construction:
- Increasing Energy Efficiency
- Using Materials Appropriately
- Conserving and Reusing Water
- Providing a Healthful Living and Working Environment (air quality) Building Attractive Structures That Will Last



WHAT DOES SUSTAINABLE MEAN?

DEFINITION: Capable of being continued with minimal long-term effect on the environment. A means of configuring construction activity so that architects, builders and home purchasers are all able to meet their needs and express their greatest potential in the present while preserving biodiversity and natural ecosystems in the future.

UNDERSTAND “LIFE-CYCLE ASSESSMENT”

Life cycle assessments (LCAs) analyze a product’s environmental impact throughout its ‘cradle-to-grave’ life span. This involves a big picture examination of the energy consumed, the raw materials used, and the extent of environmental impact at various stages of a product’s manufacture, use and disposal. Builders and architects seek products with a low life-cycle impact on the environment.

WHAT ARE USGBC, LEED, FSC, SFI, PEFC, SCS, CERTFOR, AND VOC’S

United States Green Building Council is a non-profit organization, comprised of leaders from every sector of the building industry, united by a vision to transform the building marketplace to sustainability.

LEED (Leadership in Energy and Environmental Design), a green building rating system developed by the USGBC, is the nationally accepted benchmark for the design, construction and operation of high-performance green buildings.

Forest Stewardship Council (FSC) is an international network promoting responsible management of the world’s forests. Founded in 1990, they accredit independent, third-party organization (such as SCS) who can certify forest managers and forest producers to FSC standards. Over 200 million acres of forestlands are FSC-certified worldwide. FSC chain-of-custody certification provides a system for tracking certified wood from the forest, through production and distribution, to the point of sale.

SFI (Sustainable Forestry Initiative) is a forest product certification program promoting responsible forestry and sound business practices among forest product producers. Adopted by the American Forest & Paper Association (AF&PA) in 1994, SFI is a comprehensive system of principles, objectives and performance measures. Its membership plants 1.7 million trees every day. With over 150 million acres of certified forestland in North America, SFI is among the world’s largest sustainable forestry programs. Independent, third-party organizations are approved to perform certification audits to SFI standards once they’ve met procedure & qualification standards.

SCS (Scientific Certification Systems) is a leading third-party provider of certification, auditing & testing services and standards.

Volatile Organic Compounds (VOCs) are emitted as gasses from certain solids or liquids. VOCs include a variety of chemicals, some of which may have short-term and long-term adverse health effects.

PEFC is an “umbrella” made up of international standards and national forestry standards recognized by 149 nations. PEFC does not allow wood from controversial sources. 537 millions acres are managed under PEFC standards which includes CERTFOR.



Product Information & Symbols

PRODUCT INFORMATION & SYMBOLS

All items in our catalog have a corresponding part number.

We strive to use the same part # for like or similar items within each specie.

For example; the **2-1/2 Cape Cod Casing** is available in several species and will have the same part # within each specie with the correct specie code following to ensure you receive the correct profile in the correct specie.

EXAMPLE:

2-1/2 Cape Cod Casing is part number **150**

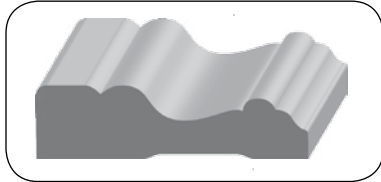

To order **150** in Solid Pine, the correct part number is **E150**
 ...Ultralight MDF is **150MUL**
 ...Oak is **150-O**
 ...Maple is **150MP**

Species Code Reference [used after each part #]

(Please note that any part # that begins with a PR indicates a primed product)

Standard Mouldings:	Hardwood Mouldings	Exterior Frames
E – Solid Pine	P – Poplar	No Code – FJ
A – FJ Pine Raw	O – Oak	F – Flat Grain Fir/Veneer VG Fir
PR – FJ Pine Primed	C – Cherry	P – Poplar
MUL – Ultralight MDF	MH – Mahogany	O – Oak
LDF – Lightweight MDF (Medium Density Fiberboard)	MP – Maple	M – Mahogany
VG – Vertical Grain Fir / Mixed Grain Douglas Fir	ALD – Alder	KA – Knotty Alder
No Code – Redwood	KA – Knotty Alder	
AR – FJ Redwood		

Interior Jambs:	ValuFlex™	Base or Chair Rail Bullnose Radius Corner
SP – Solid Pine	Use the entire part# and specie code with a "F" appended to the end	Use the entire part# and specie code with a "W" appended to the end
No Code – FJ Pine	F – ValuFlex	W – Standard 3/4" radius corner
P – Poplar		
M – Ultralight MDF		
O – Oak		
F – Vertical Grain Fir		
ALD – Superior Alder		
MH – Mahogany		



About Moulding

Mouldings are used to decorate a room by lending their decorative patterns to enhance doorways, windows, ceilings, walls, etc. Mouldings can be an extension of one's creative ideas or concepts giving an unlimited amount of uses to each and every item. Each individual's ideas are unique and personal and can be an expression of one's own taste and style that lend a home or office a special look and feel.

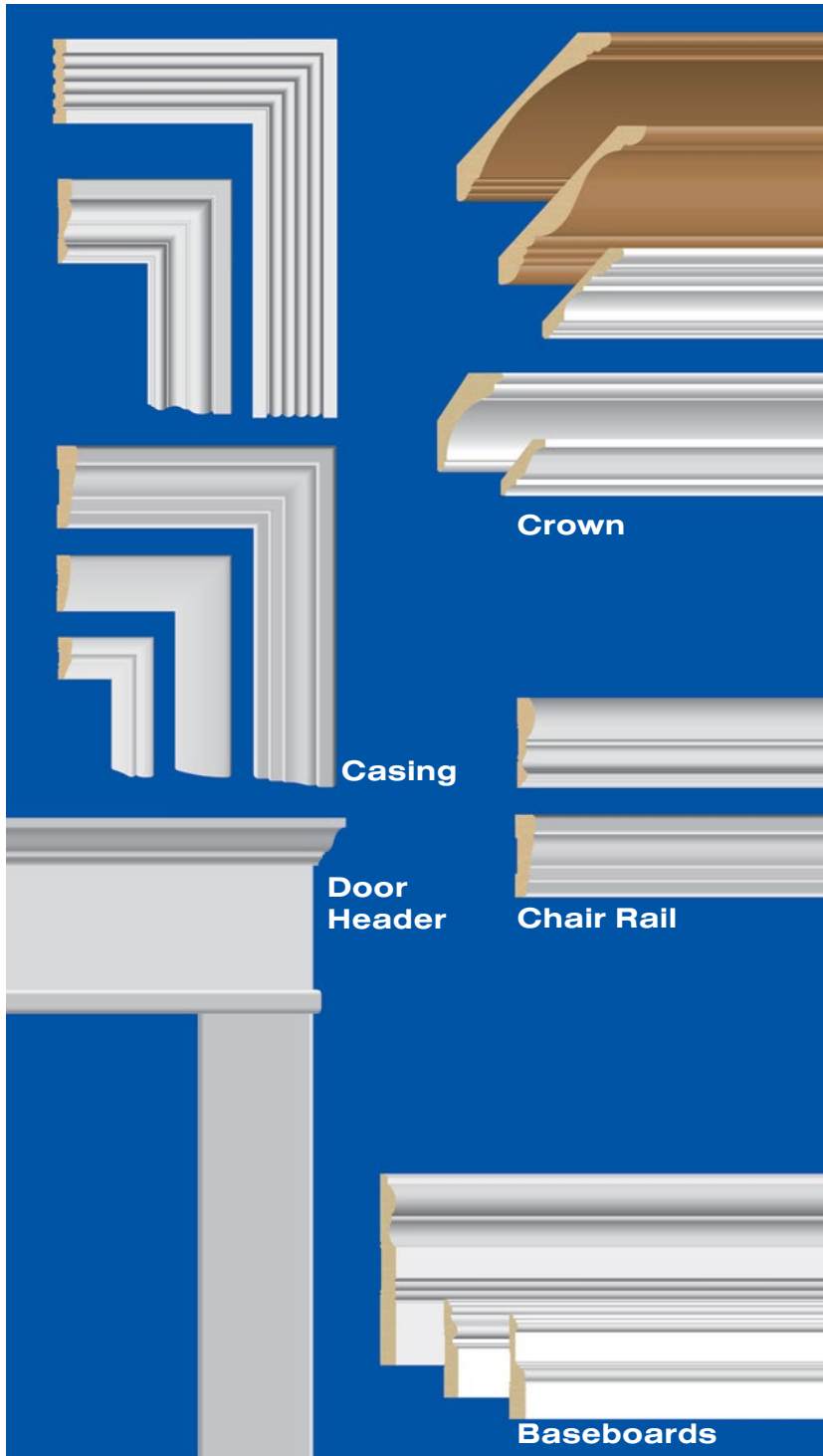

Crown and corner mouldings are used where the wall joins the ceiling. These can be used alone and will reveal tremendous depth. Crown mouldings can also be built up using lineal mouldings, baseboards, casings, chair rails, or panel moulding with taller ceilings. Large combination details are two or more pieces of mouldings installed together to create a unique, large detail.

Door headers and top caps are used to form a pediment above door and/or window openings. They run horizontally either on top of mitered casings to give height to the opening or they run horizontally at the head jamb of an opening with casing dying into the 27/32" flat bottom. Door headers can be used in fireplace applications (as wide casings or base).

Chair rails are used approximately 30" to 40" from the floor, running horizontally to form a "wainscot" look. Chair rail mouldings can also be used as panel mouldings to form panels on walls or ceilings. For larger chair rails, use casings with backbands installed horizontally.

Casings are used to trim around doors and windows (door mouldings can show more mass than windows). Casings can also be used as larger chair rails, or upper horizontal linear banding around rooms.

Baseboards are used where the wall joins the floor. Baseboard is excellent when turned upside-down and used with crown mouldings to form larger crown details and with the addition of panel moulding, baseboards can be made taller creating larger baseboard or larger crown details.



Examples of Moulding



Solid Pine

BEAUTIFULLY GRAINED AND EASY TO WORK WITH

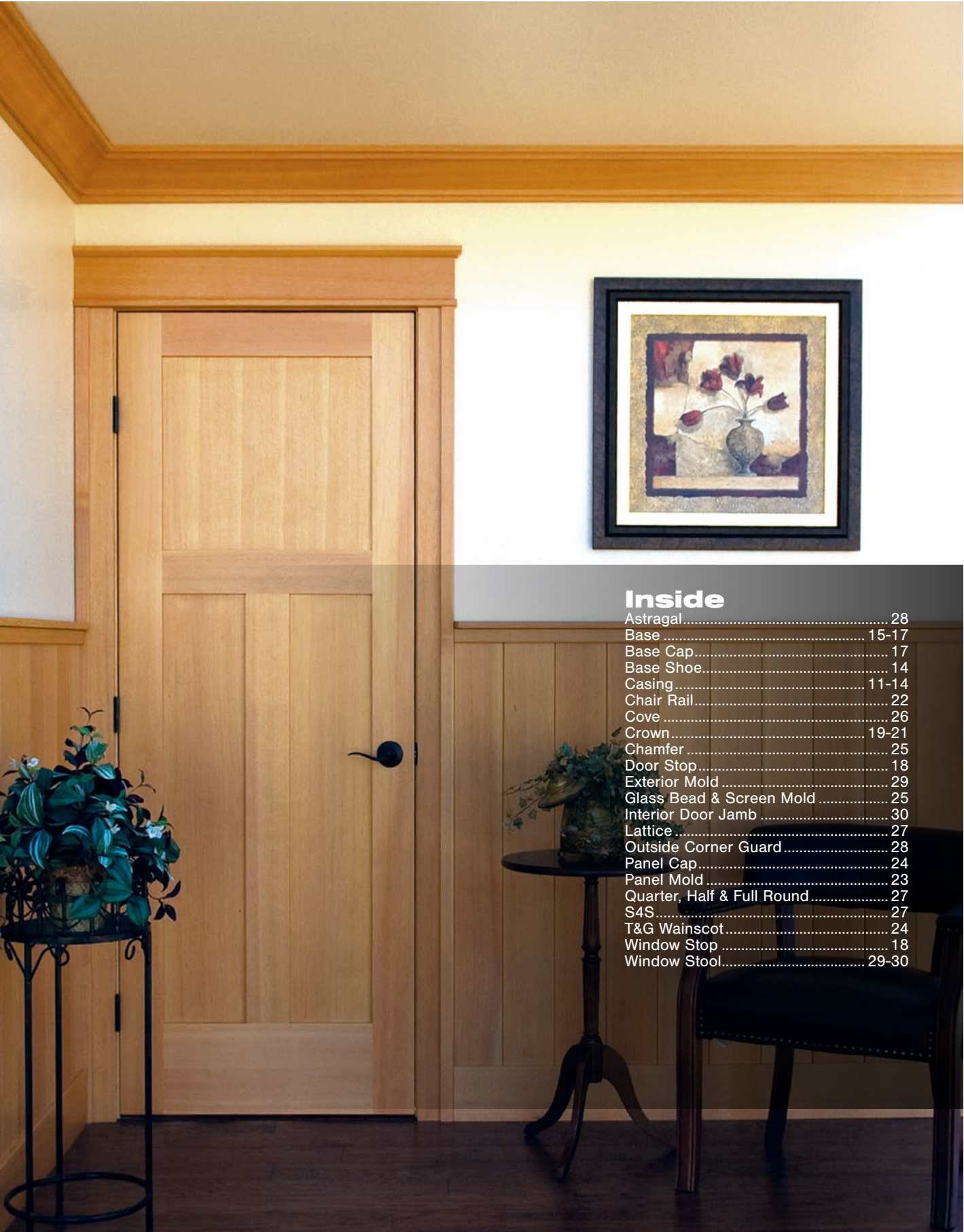

Inside

Astragal.....	28
Base	15-17
Base Cap.....	17
Base Shoe.....	14
Casing.....	11-14
Chair Rail.....	22
Cove	26
Crown.....	19-21
Chamfer	25
Door Stop.....	18
Exterior Mold	29
Glass Bead & Screen Mold	25
Interior Door Jamb	30
Lattice	27
Outside Corner Guard.....	28
Panel Cap.....	24
Panel Mold	23
Quarter, Half & Full Round.....	27
S4S.....	27
T&G Wainscot.....	24
Window Stop	18
Window Stool.....	29-30



Solid Pine

BEAUTIFULLY GRAINED AND EASY TO WORK WITH



Solid Pine, valued primarily for its appearance and workability, has long been the moulding stocked by most lumberyard and home centers.

There are many species of solid pine, including domestic Ponderosa and Sugar Pine, along with imported lumber from various countries such as Chile, Russia, and Brazil. With the concerns over deforestation and endangered species, domestic Ponderosa and Sugar Pine became limited in supply and sold at a premium price compared to other types of domestic or imported pine.

Solid Pine is beautifully grained and is easy to work with, and offers many choices for finishing. Pine can simply be clear coated to show its natural warmth, or it can be stained in a variety of colors, antiqued, or painted. Solid Pine often has a special place in the hearts of those who love wood.

LIGHTWEIGHT & DURABLE

CUTS & NAILS EASILY

PREMIUM STAIN OR PAINTGRADE

(items are approximate scale only)

1-1/8" to 2" CASING

Lengths Available: 6' thru 16'

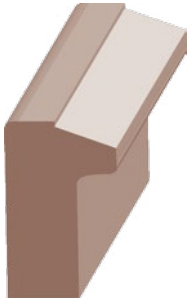

Back Band Casing
(Lips 5/8" casing)

11/16 x 1-1/8

E190

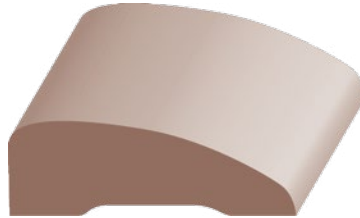

Oval Streamline Casing

1/2 x 1-1/2

E104

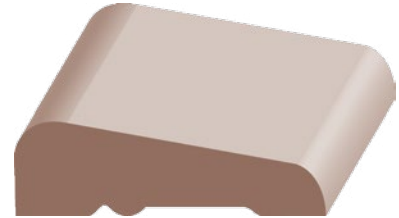

Flat Streamline Casing

1/2 x 1-5/8

E101

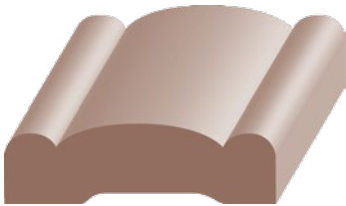

Bead & Barrel Casing

1/2 x 1-5/8

E111

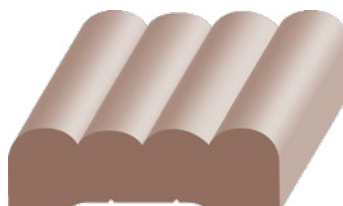

4-Bead Casing

1/2 x 1-5/8

E112

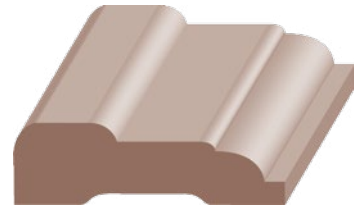

#1550 Casing

1/2 x 1-5/8

E113



Flat Streamline Casing

5/8 x 1-5/8

E102

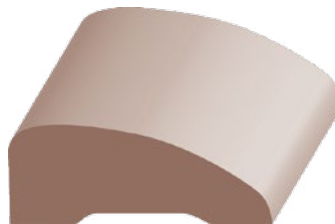

Oval Streamline Casing

5/8 x 1-5/8

E105

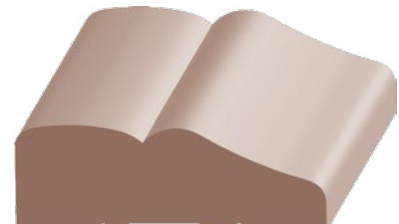

#711 Casing

5/8 x 1-5/8

E107

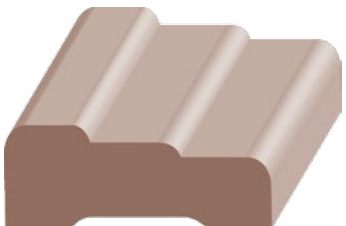

3-Step Casing

5/8 x 1-5/8

E109



Clamshell Casing

5/8 x 2

E121



2-1/4" to 2-1/2" CASING

Lengths Available: 6' thru 16'

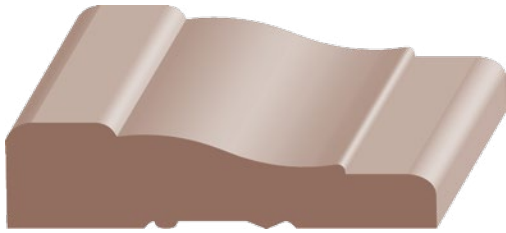

#356 Casing 11/16 x 2-1/4
E152

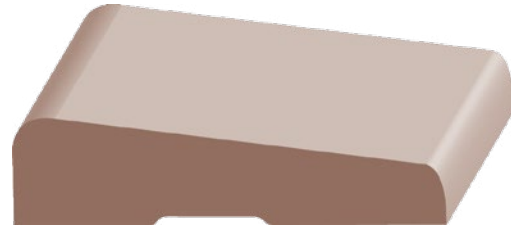

Flat Streamline Casing 5/8 x 2-1/2
E103

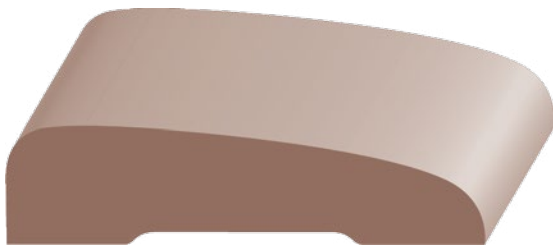

Oval Streamline Casing 5/8 x 2-1/2
E106

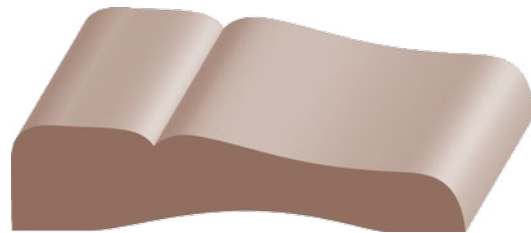

#711 Casing 5/8 x 2-1/2
E108

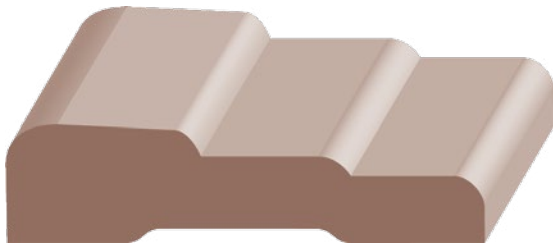

3-Step Casing 5/8 x 2-1/2
E110

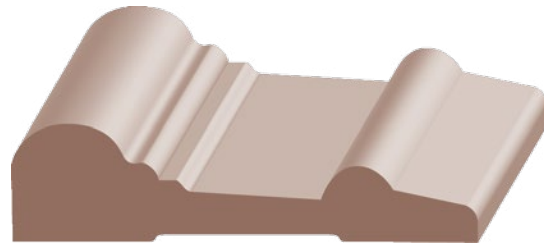

Universal Casing 5/8 x 2-1/2
E115

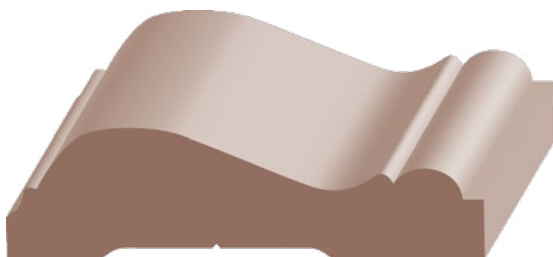

**Colonial Casing/
Chair Rail** 11/16 x 2-1/2
E116



2 Round Edge Casing 5/8 x 2-1/2
E120

(items are approximate scale only)

2-1/2" to 3-1/2" CASING

Lengths Available: 6' thru 16'

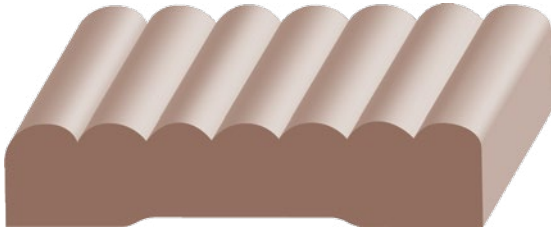

7-Bead Casing $5/8 \times 2-1/2$
E122

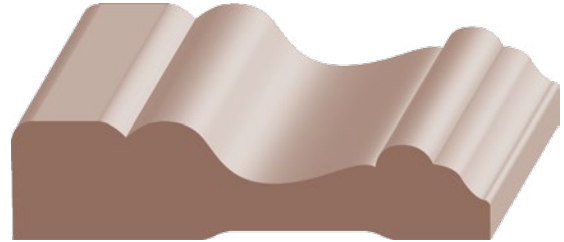

Cape Cod Casing $5/8 \times 2-1/2$
E150

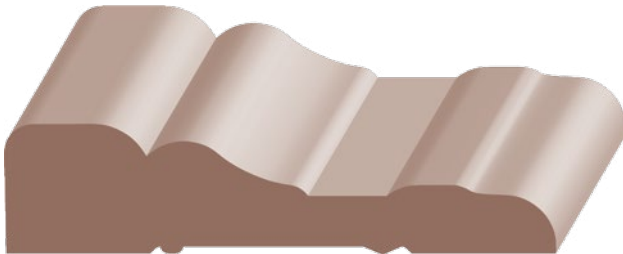

Colonial Casing $11/16 \times 2-7/8$
E119



Mullion Casing $1/4 \times 3-1/2$
E114

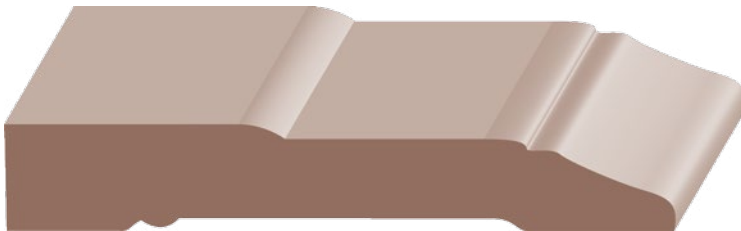

**Colonial Casing/
Base** $9/16 \times 3-1/2$
E117



3-1/2" to 4-1/4" CASING

Lengths Available: 6' thru 16'

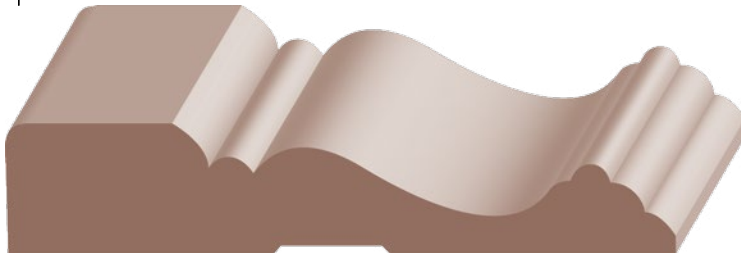

Cape Cod Casing 11/16 x 3-1/2
E155

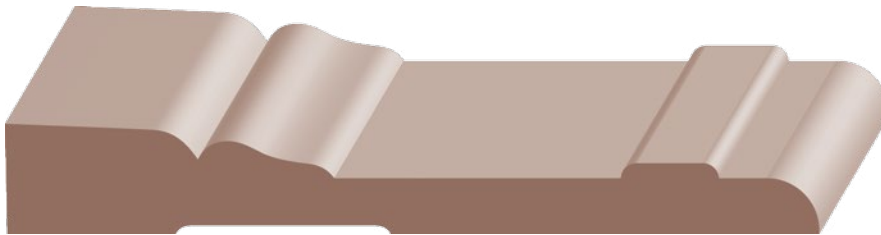

Colonial Casing/Base 9/16 x 4-1/4
E118

3/4" to 1-1/2" BASE & BASE SHOE

Lengths Available: 6' thru 16'

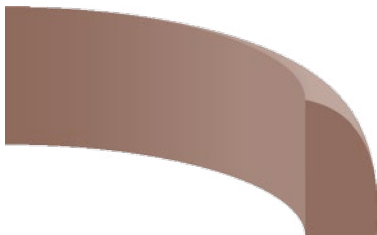

Base Shoe Corner

- E300W** 3/8 x 3/4
- E300BW** 1/2 x 3/4
- 3001W** 3/8 x 3/4 (goes over 3/8" or 7/16")
- 3002W** 3/8 x 3/4 (goes over 1/2" or 9/16")
- 3003W** 3/8 x 3/4 (goes over 5/8" or 7/16")
- 3001BW** 1/2 x 3/4 (goes over 3/8" or 7/16")
- 3002BW** 1/2 x 3/4 (goes over 1/2" or 9/16")
- 3003BW** 1/2 x 3/4 (goes over 5/8" or 7/16")

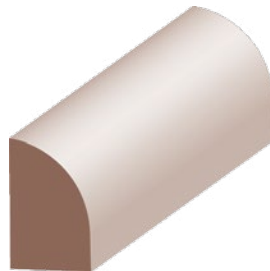

Base Shoe 3/8 x 3/4
E300

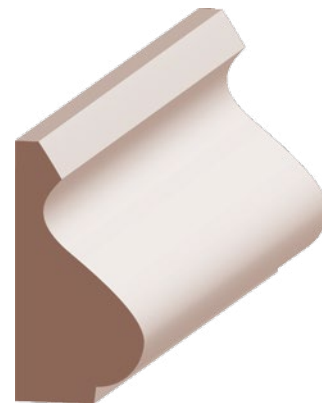

Base Cap 11/16 x 1-3/8
E614

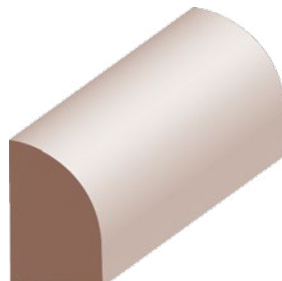

Base Shoe 1/2 x 3/4
E300B

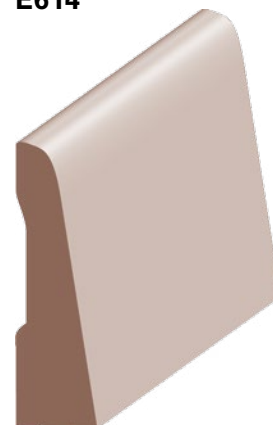

Flat Base 7/16 x 1-1/2
E301

1-9/16" to 2-1/2" BASE & BASE SHOE

Lengths Available: 6' thru 16'

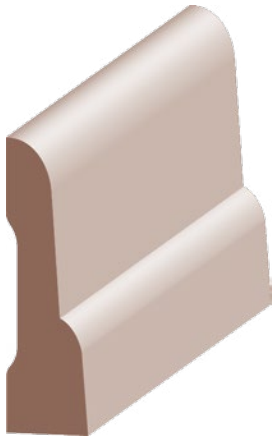

**Combination
Base & Shoe** $7/16 \times 1-9/16$
E308

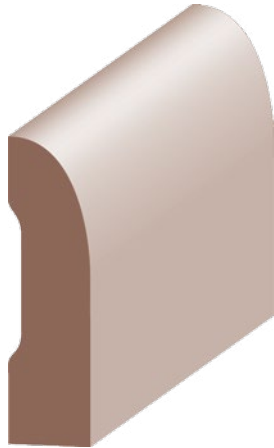

**Streamline
Base** $7/16 \times 1-5/8$
E302

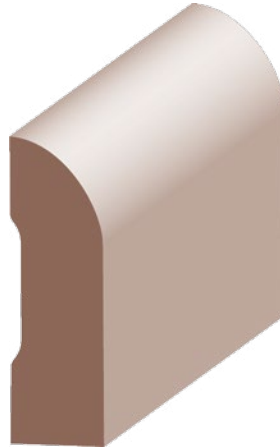

**Streamline
Base** $1/2 \times 1-5/8$
E303

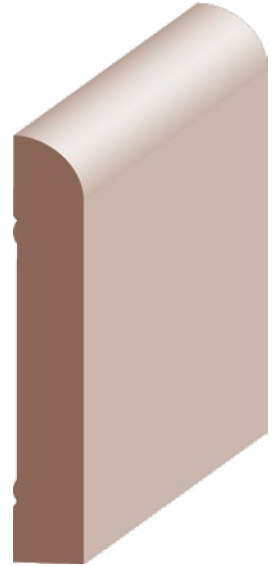

**Streamline
Base** $3/8 \times 2-1/4$
E304

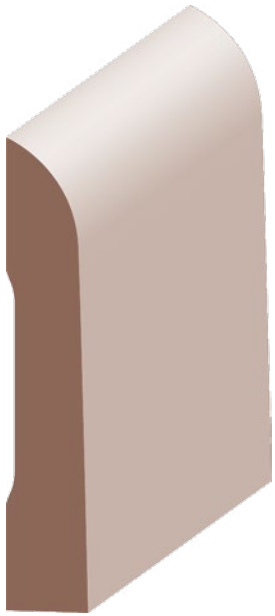

**Streamline
Base** $7/16 \times 2-1/2$
E305



#711 Base $7/16 \times 2-1/2$
E310S

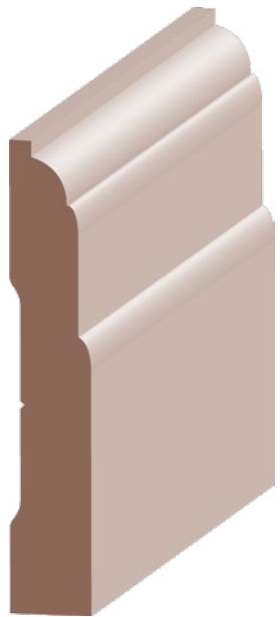

#1550 Base $7/16 \times 2-1/2$
E313

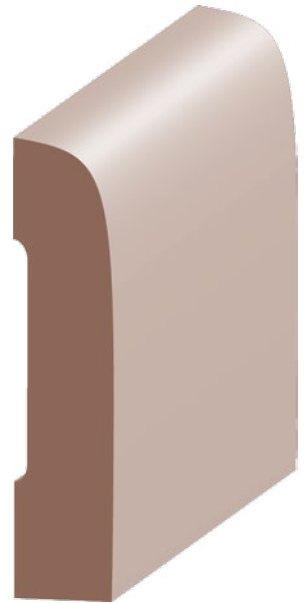

**Streamline
Base** $1/2 \times 2-1/2$
E306



2-1/2" to 3-1/2" BASE

Lengths Available: 6' thru 16'

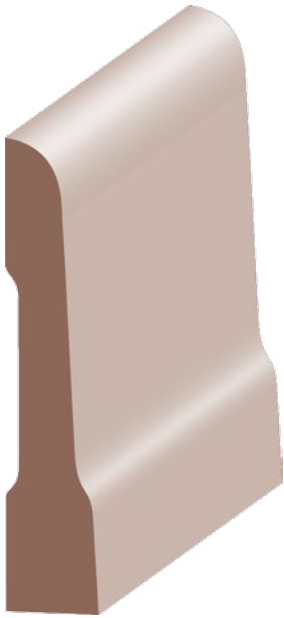

**Combination
Base & Shoe
E309**

1/2 x 2-1/2



**#711 Base
E310**

1/2 x 2-1/2

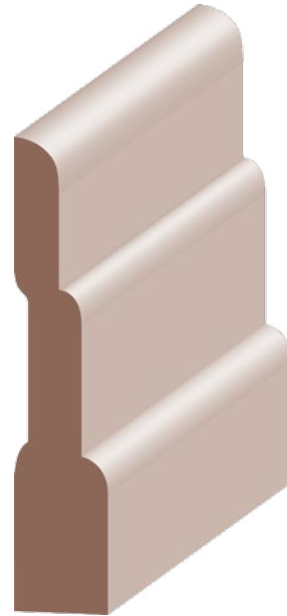

**3-Step Base
E312**

1/2 x 2-1/2

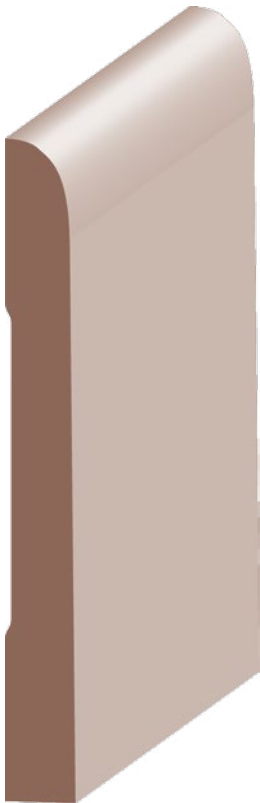

**Streamline Base
E307**

7/16 x 3-1/2

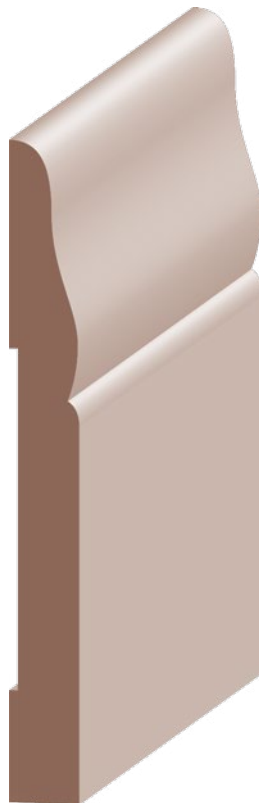

**#711 Base
E311**

7/16 x 3-1/2



**3-Step Base
E322**

1/2 x 3-1/2

(items are approximate scale only)

3-1/2" to 4-1/4" BASE

Lengths Available: 6' thru 16'

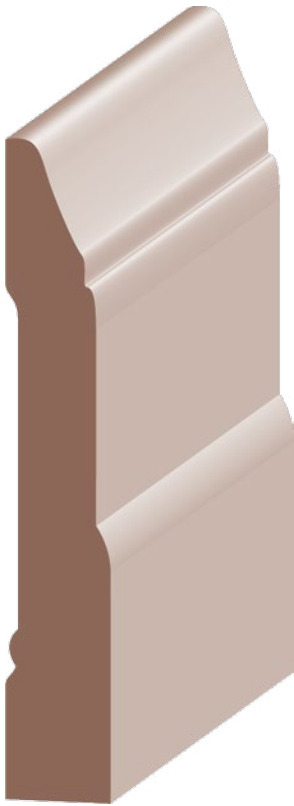

Colonial Base 9/16 x 3-1/2
E117



Cape Cod Base 9/16 x 4
E318

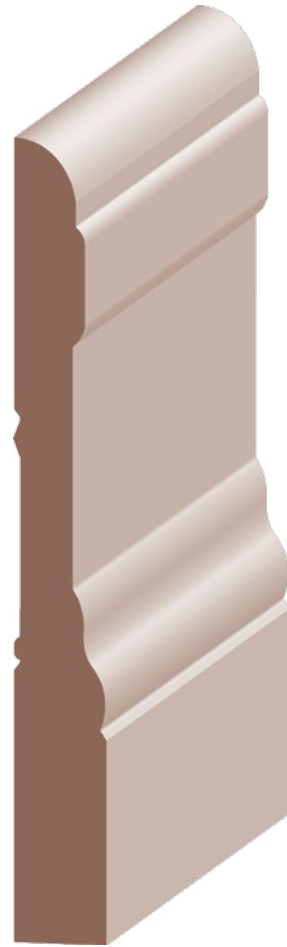

Colonial Base 9/16 x 4-1/4
E118



WINDOW & DOOR STOP

Lengths Available: 6" thru 16"

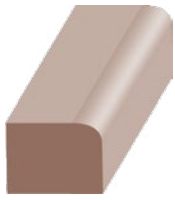

1 Round Edge Stop $3/8 \times 1/2$
E200

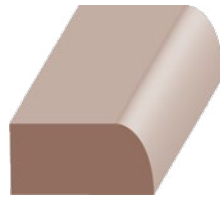

1 Round Edge Stop $3/8 \times 3/4$
E201

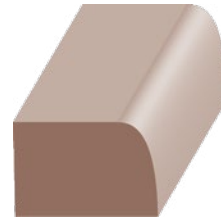

1 Round Edge Stop $1/2 \times 3/4$
E204

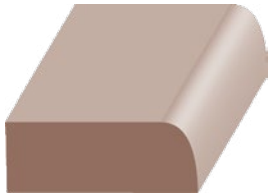

1 Round Edge Stop $3/8 \times 1$
E208

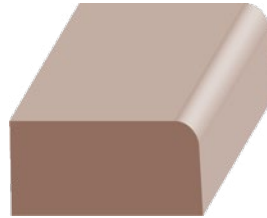

1 Round Edge Stop $1/2 \times 1$
E205



1 Round Edge Stop $3/8 \times 1-1/4$
E202



1 Round Edge Stop $1/2 \times 1-1/4$
E206



1 Round Edge Stop $3/8 \times 1-5/8$
E203



1 Round Edge Stop $1/2 \times 1-5/8$
E207

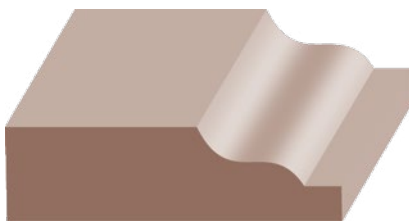

Ogee Stop $1/2 \times 1-3/4$
E210

(items are approximate scale only)

1-5/8" to 3-3/8" CROWN & CORNICE

Lengths Available: 6' thru 16'

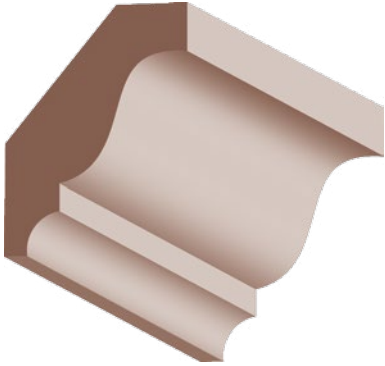

Colonial Crown 9/16 x 1-5/8
E400

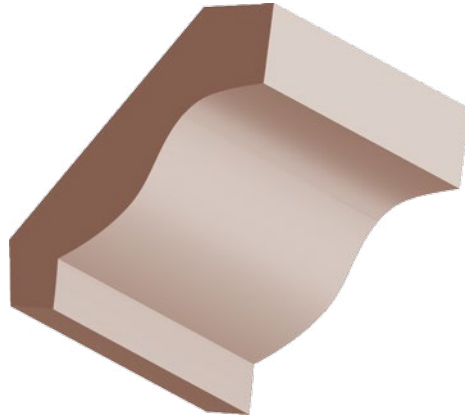

Colonial Crown 9/16 x 2-1/4
E401

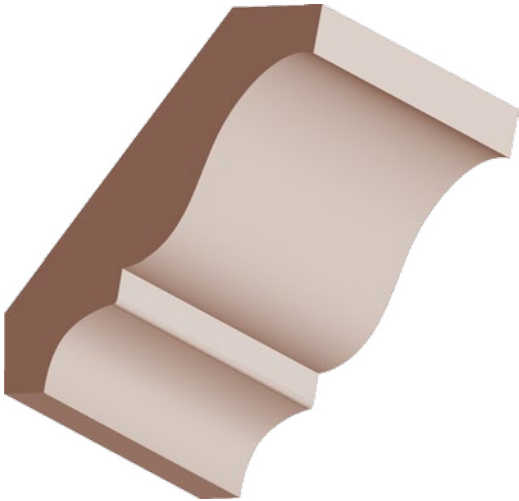

Colonial Crown 9/16 x 2-1/4
E418

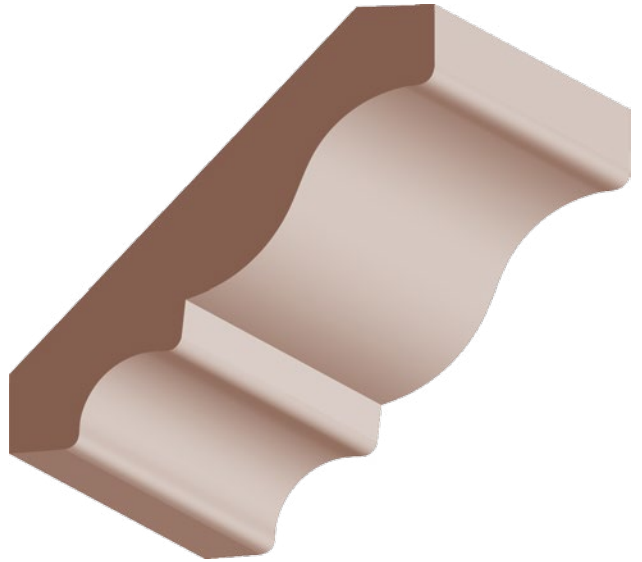

Colonial Crown 9/16 x 3-3/8
E405



3-1/2" to 4-1/2" CROWN & CORNICE

Lengths Available: 6' thru 16'

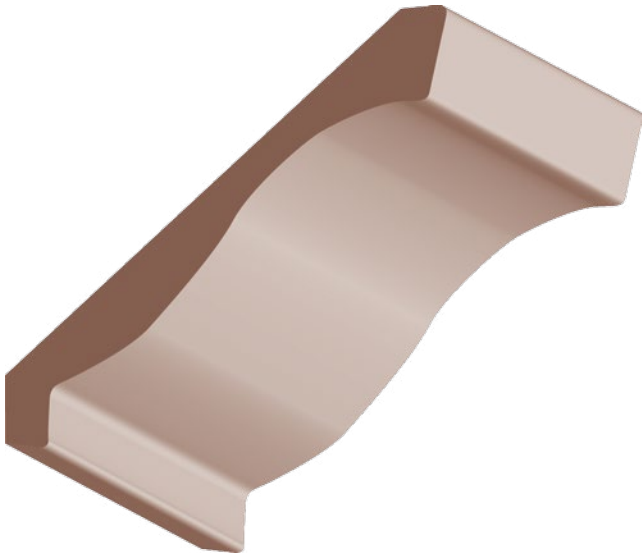

Crown
E402 9/16 x 3-1/2

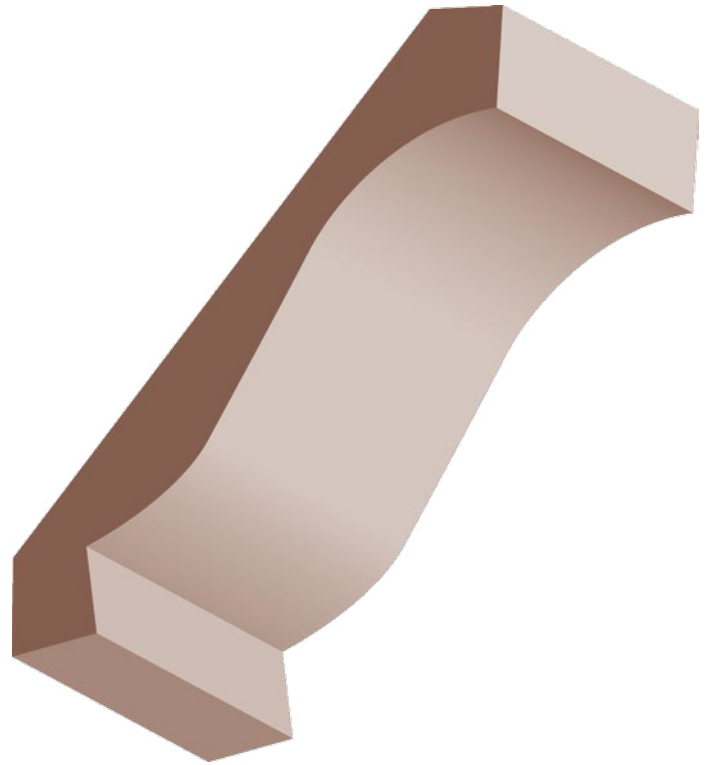

Crown
E403 9/16 x 4-1/4

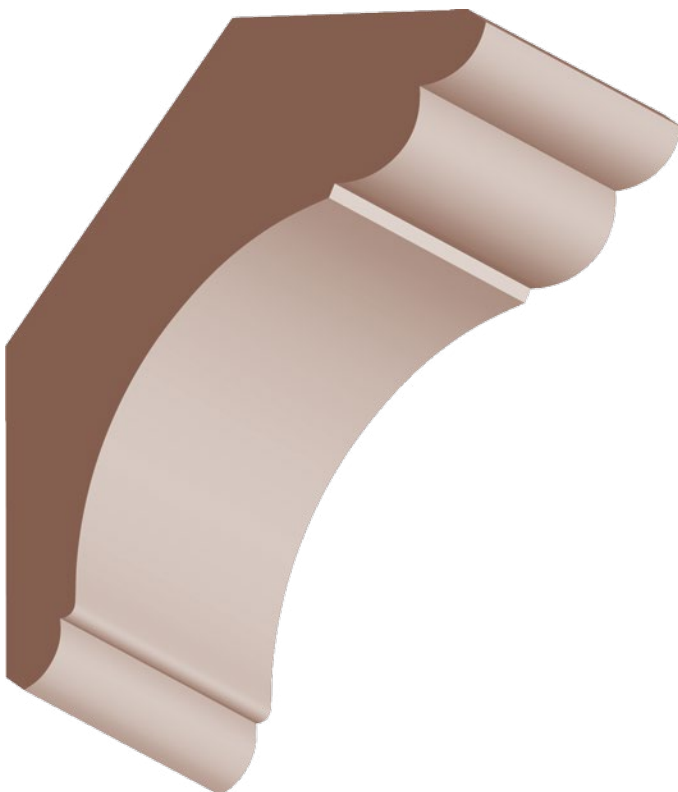

Cornice
E407 1-1/8 x 4-1/2

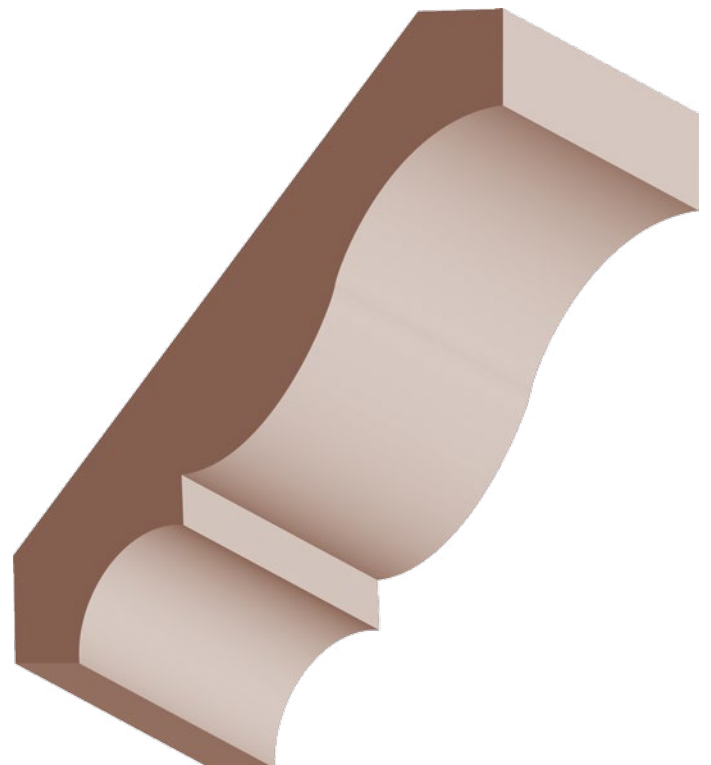

Colonial Crown
E406 9/16 x 4-1/2

(items are approximate scale only)

5-1/2" to 6" CROWN & CORNICE

Lengths Available: 6' thru 16'

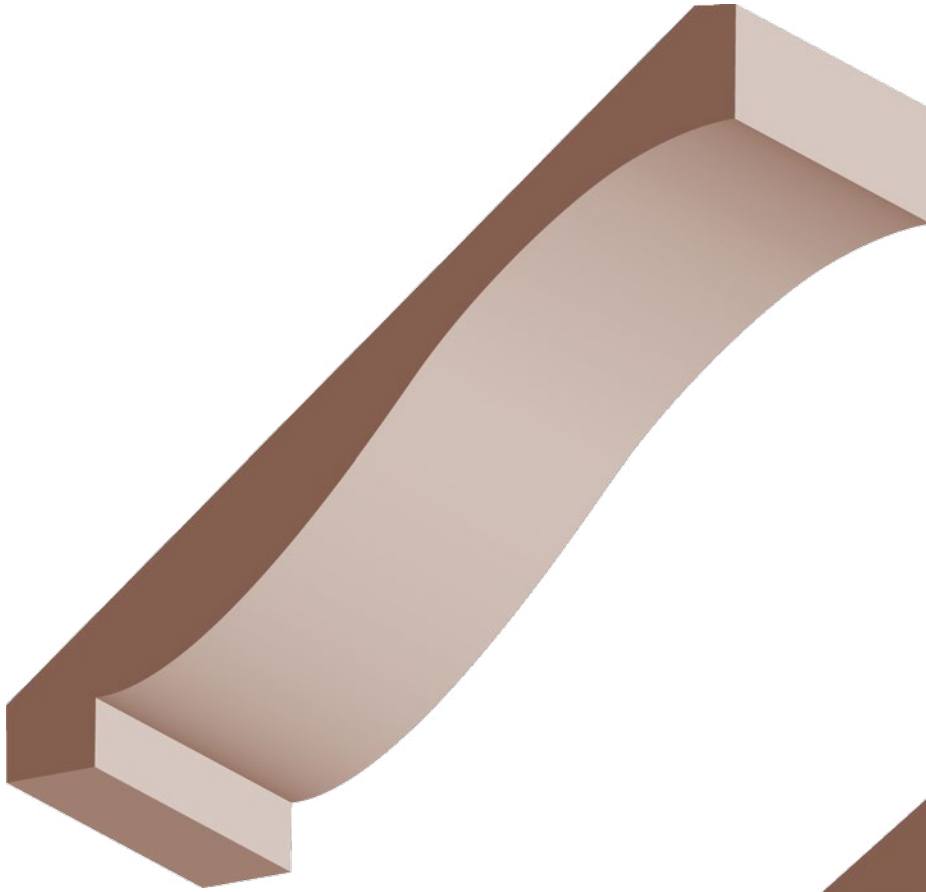

Crown 9/16 x 5-1/2
E404

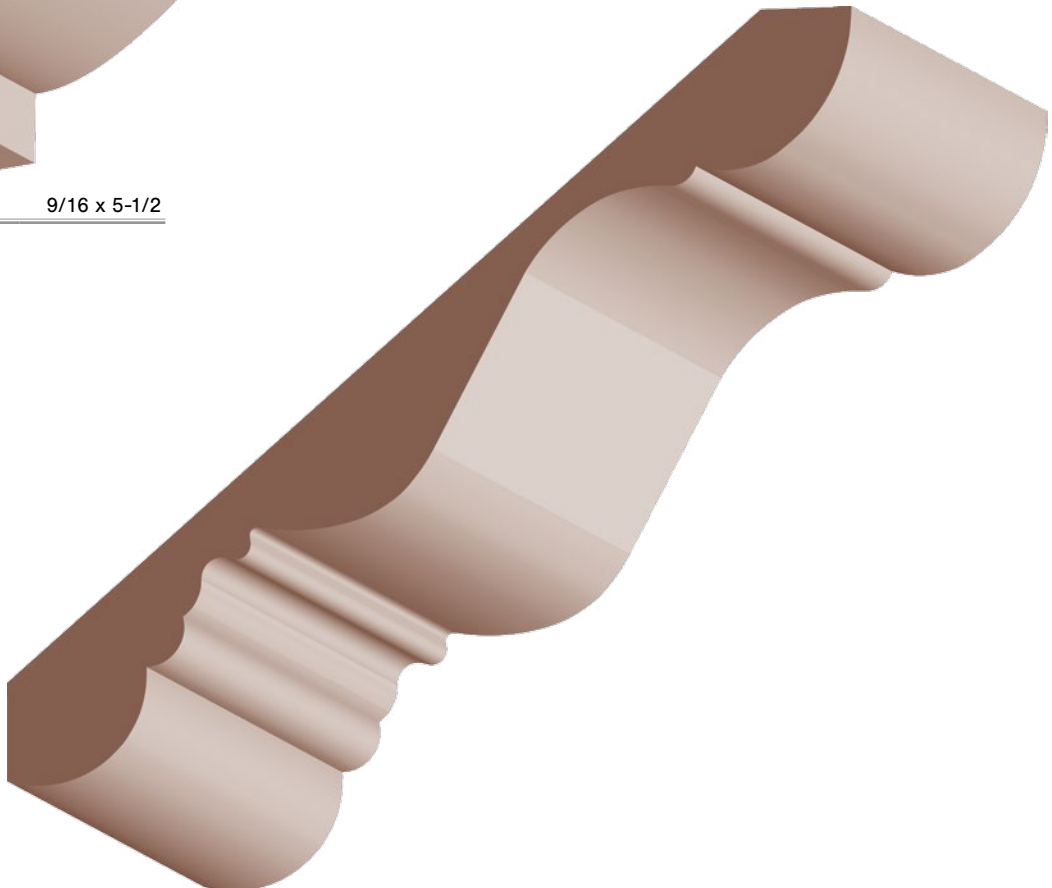

Crown 11/16 x 6
E410



CHAIR RAIL

Lengths Available: 6" thru 16"

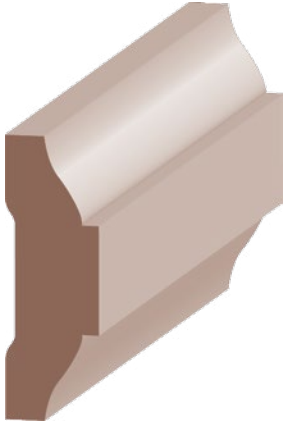

Chair Rail 1/2 x 1-1/2
E650



Chair Rail 9/16 x 2-1/2
E651

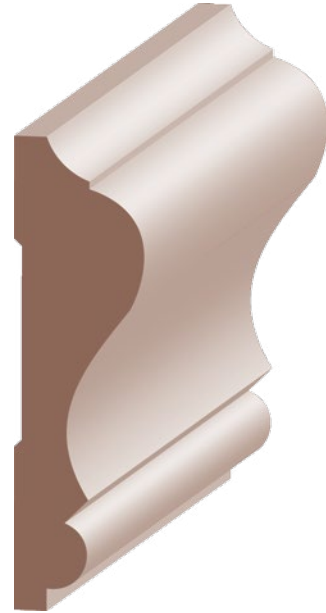

Colonial Chair Rail 11/16 x 2-1/2
E652

PANEL MOLD CORNERS

Sold as Each



Resin M-340
Corner 1-1/16 x 1-1/2
(Matches E607) 7' radius
607ARC



Resin M-400
Corner 3/4 x 1-7/8
(Matches E608/608-0) 7' radius
608ARC

(items are approximate scale only)

PANEL MOLD

Lengths Available: 6' thru 16'

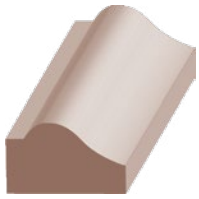

Panel Mold $3/8 \times 5/8$
E600

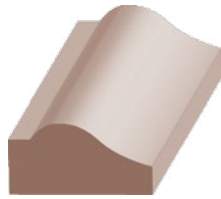

Panel Mold $5/8 \times 3/4$
E601

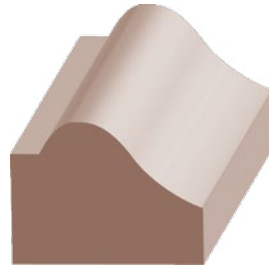

Panel Mold $3/4 \times 1$
E602

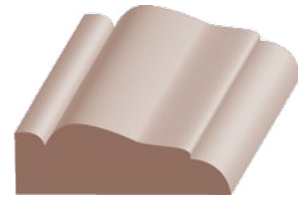

Panel Mold $3/8 \times 1-1/8$
E604

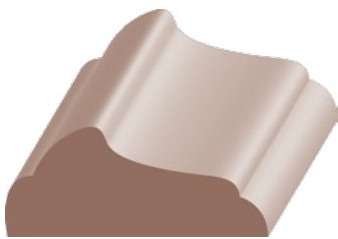

Panel Mold $9/16 \times 1-3/8$
E606

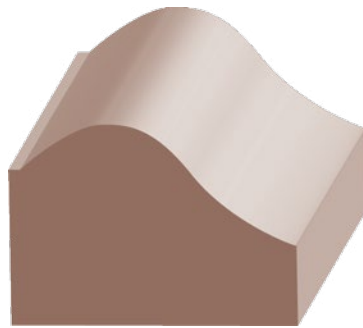

Panel / Brick Mold $1-1/16 \times 1-1/2$
E603

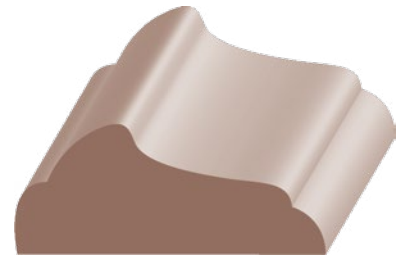

Beauty M-340
Panel Mold $1-1/16 \times 1-1/2$
E607

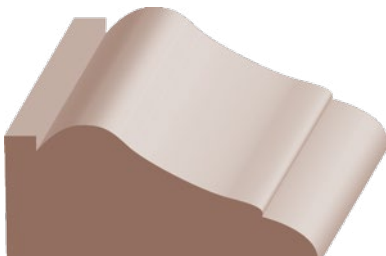

Panel Mold $3/4 \times 1-5/8$
E605

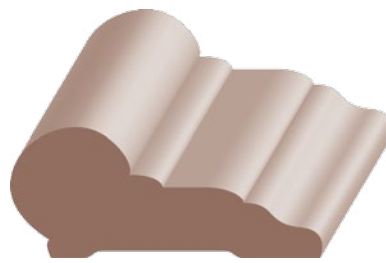

1139 Picture Mold
(Colonial Craftsman) $11/16 \times 1-5/8$
E905

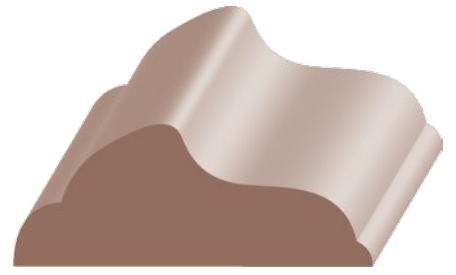

Beauty M-400
Panel Mold $3/4 \times 1-7/8$
E608

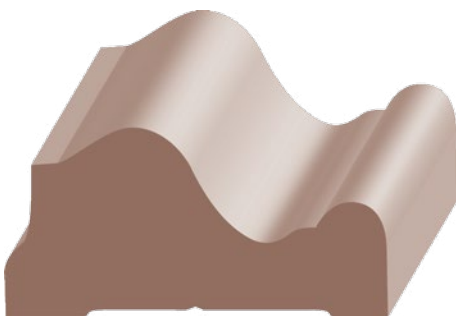

Decorative
Panel Mold 1×2
E610

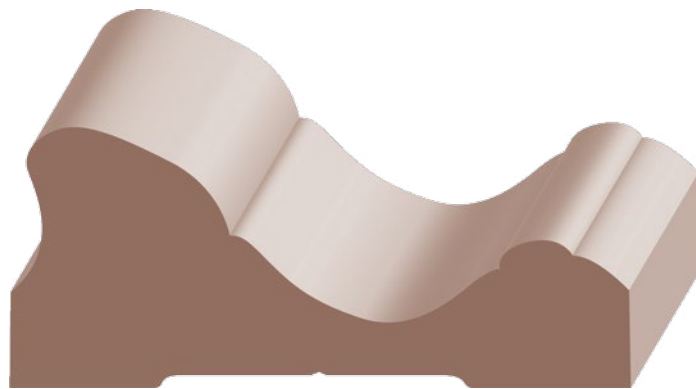

Decorative Panel
Mold $1-3/8 \times 3-1/4$
E611



PANEL CAP

Lengths Available: 6' thru 16'

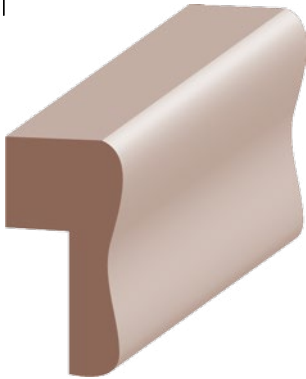

Wainscot Cap

(w/1/4" Rab't)

5/8 x 1-1/4

E731

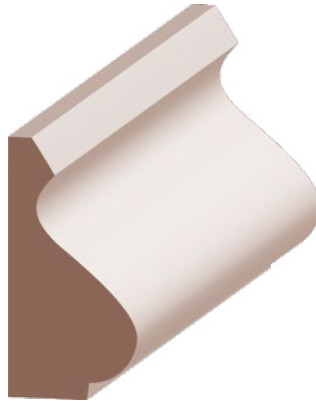

Panel Mold

11/16 x 1-3/8

E614

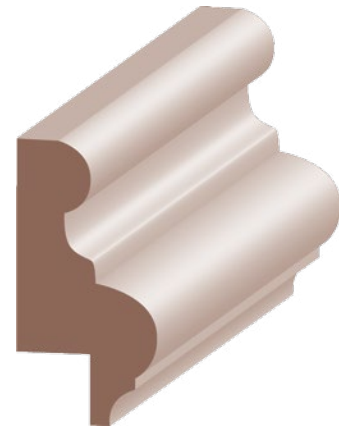

Panel Cap *(w/3/8" Rab't)*

3/4 x 1-1/2

E620

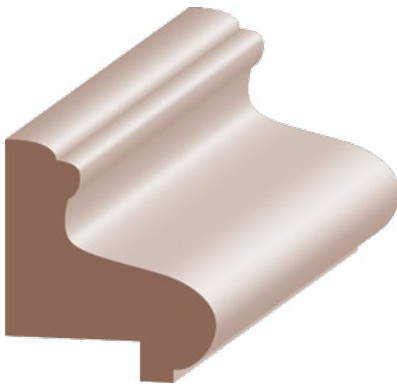

Raised Panel Cap

(w/3/4" Rab't)

1-1/8 x 1-1/4

E613

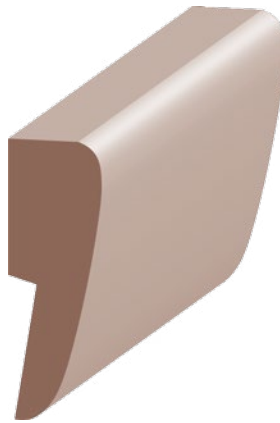

Panel Cap *(w/1/8" Rab't)*

1 x 1-1/2

E730

T&G WAINSCOT

Lengths Available: 6' thru 16'



Beaded T&G Wainscot

3/8 x 3-1/4

E2000

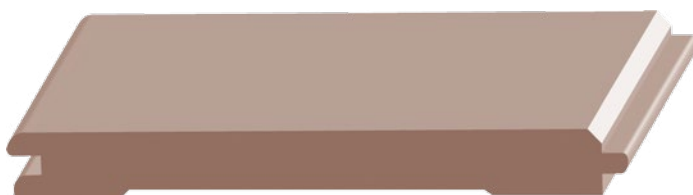

Flat T&G Wainscot

3/8 x 3-1/4

E2001

(items are approximate scale only)

BEAD & SCREEN MOLD

Lengths Available: 6' thru 16'



Glass Bead $3/8 \times 3/8$
E597



Glass Bead $1/4 \times 7/16$
E596

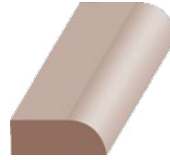

Insert $3/16 \times 1/2$
E590

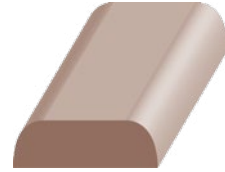

Flat Screen Mold $1/4 \times 3/4$
E591

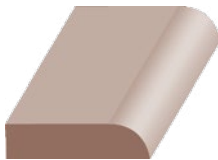

Scribe Mold $3/16 \times 3/4$
E593

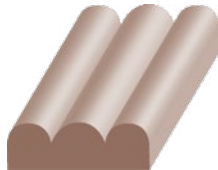

Beaded Screen $1/4 \times 3/4$
E592

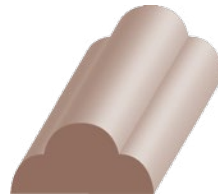

Cloverleaf $3/8 \times 3/4$
E594

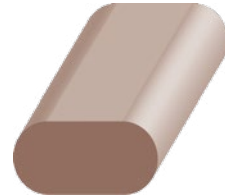

Parting Bead $3/8 \times 3/4$
E901

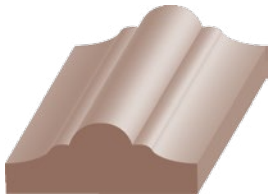

Flat Hoffco $3/8 \times 1$
E903

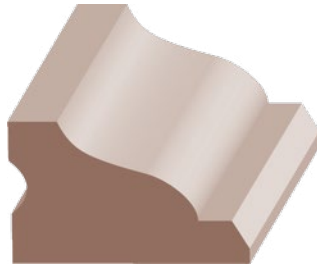

Drip Mold $3/4 \times 1-1/4$
E904

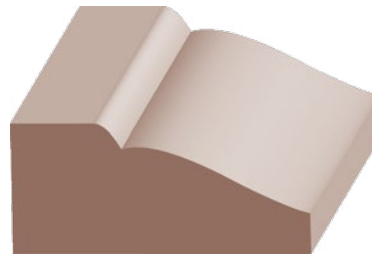

Band Mold $11/16 \times 1-9/16$
E900

CHAMFER

Lengths Available: 6' thru 16'



Chamfer $1/2 \times 1/2$
E906

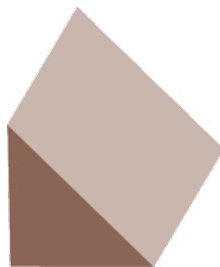

Chamfer $3/4 \times 3/4$
E907

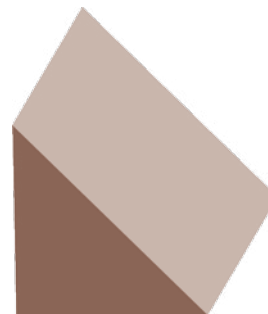

Chamfer 1×1
E908



NOSE & COVE

Lengths Available: 6' thru 16'



Cove $3/8 \times 3/8$
E520

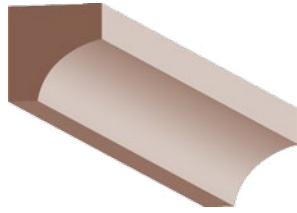

Cove $1/2 \times 1/2$
E521

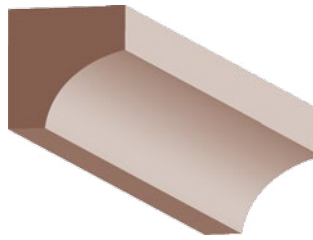

Cove $5/8 \times 5/8$
E522

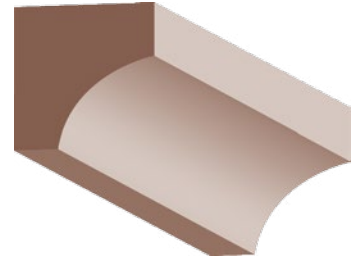

Cove $3/4 \times 3/4$
E523

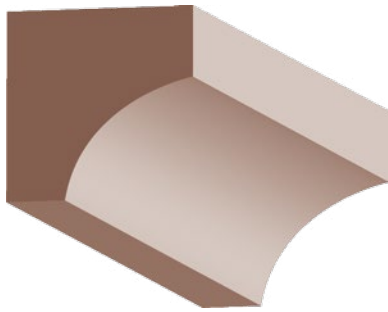

Cove 1×1
E524



Linoleum Cove $7/16 \times 1-1/4$
E527

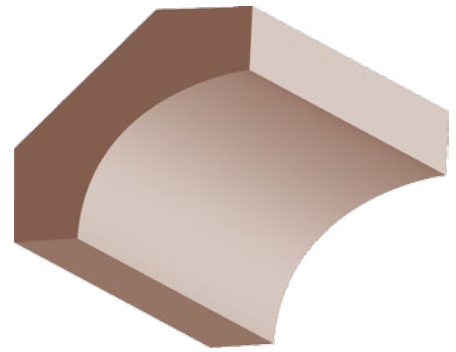

Sprung Cove $5/8 \times 1-5/8$
E525

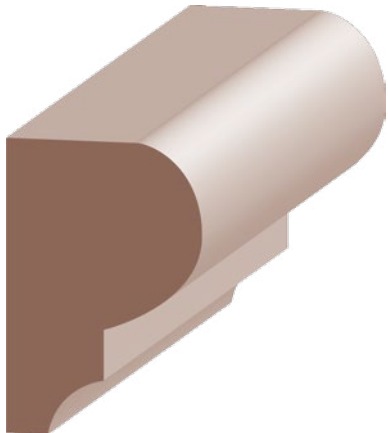

Nose & Cove $1 \times 1-5/8$
E909

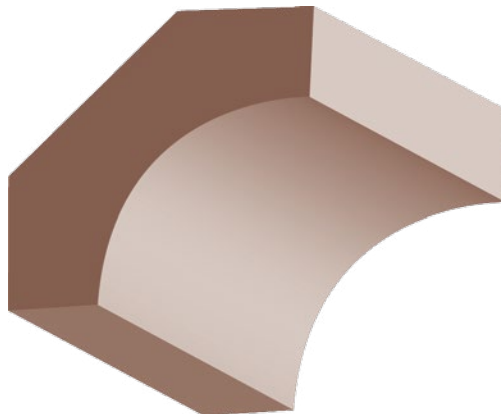

Sprung Cove $5/8 \times 2-1/4$
E526

QUARTER, HALF & FULL ROUND

Lengths Available: 6' thru 16'

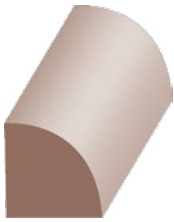

Quarter Round

E500	1/4 x 1/4
E501	3/8 x 3/8
E502	1/2 x 1/2
E503	5/8 x 5/8
E504	3/4 x 3/4
E505	1 x 1

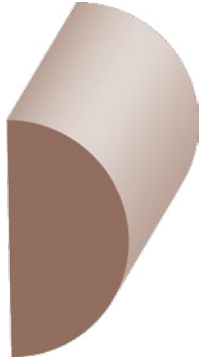

Half Round

E570	1/4 x 1/2
E571	5/16 x 5/8
E572	3/8 x 3/4
E573	1/2 x 1
E574	5/8 x 1-1/4

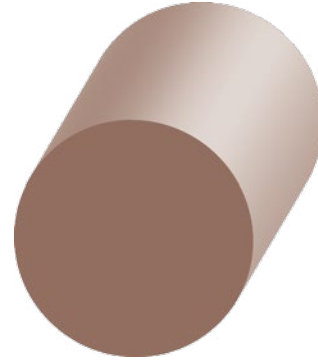

Full Round

802P	1-1/4
803P	1-3/8

S4S & LATTICE

Lengths Available: 6' thru 16'



S4S (Unprimed)

E705	1/2 x 1/2
E706	1/2 x 3/4
E707	1/2 x 1-1/2
E708	1/2 x 2-1/2
E709	1/2 x 3-1/2
E710	1/2 x 5-1/2
E711	3/4 x 3/4
E713	11/16 x 1-5/8 (1x2)
E714	11/16 x 2-1/2 (1x3)
E715	11/16 x 3-1/2 (1x4)
E716	1 x 1
E717	1-9/16 x 1-9/16 (2x2)
E719	1-1/2 x 1-1/2 (4EE)
E750	3/4 x 5-1/2 (1x6) C&BTR
E751	3/4 x 7-1/4 (1x8) C&BTR
E753	3/4 x 11-1/4 (1x12) C&BTR



Lattice

E700	1/4 x 1-1/8
E701	1/4 x 1-1/4
E702	1/4 x 1-5/8
E703	1/4 x 2-1/2
E704	1/4 x 3-1/2



OUTSIDE CORNER GUARD

Lengths Available: 6' thru 16'

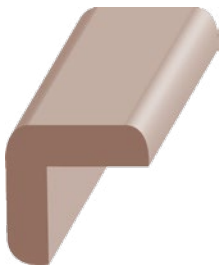

Outside Corner Guard

3/4 x 3/4

E720

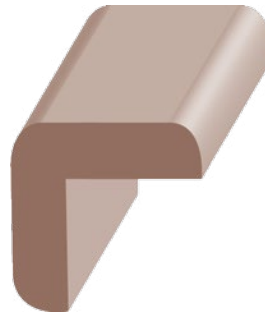

Outside Corner Guard

1 x 1

E721



Detail Outside Corner Guard

1-1/8 x 1-1/8

E723

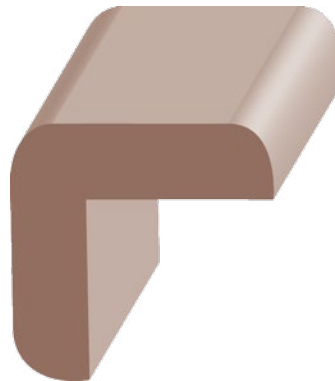

Outside Corner Guard

1-3/8 x 1-3/8

E722

ASTRAGAL

Lengths Available: 6' thru 16'

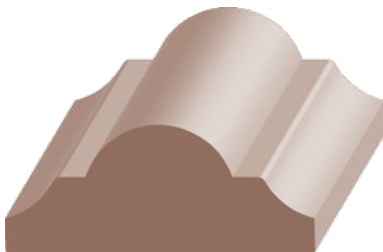

Flat Astragal

11/16 x 1-5/8

E660

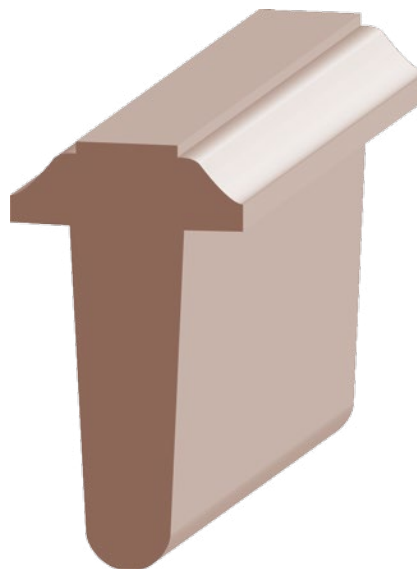

T-Astragal for 1-3/4" Doors

1-1/4 x 2-1/4

E661

(items are approximate scale only)

EXTERIOR MOLD

Lengths Available: 6' thru 16'

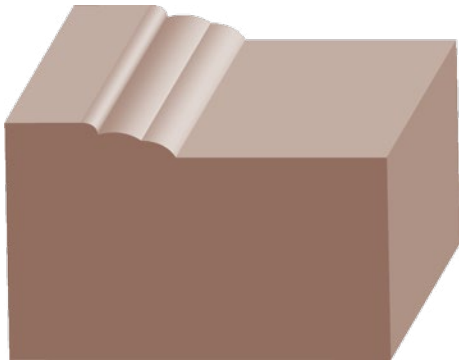

**180 Eastern
Brick Mold** 1-1/4 x 2
E612

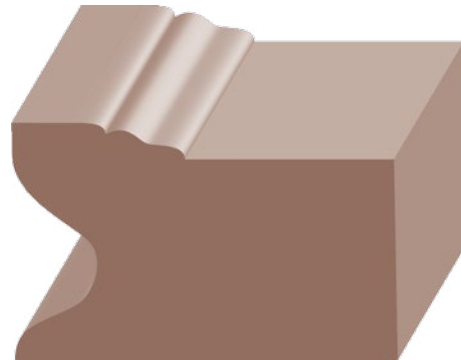

**180 Eastern Brick
Mold w/ Stucco Key** 1-1/4 x 2
B612

WINDOW STOOL

Lengths Available: 6' thru 16'



Flat Stool 11/16 x 4-3/4
E980



Flat Stool 11/16 x 5-1/2
E979



Flat Stool 11/16 x 7-1/4
E985



WINDOW STOOL

Lengths Available: 6' thru 16'



Rab't Stool 7/8 x 2-1/2
E981



Rab't Stool 7/8 x 3-1/2
E982



Rab't Stool 7/8 x 5-1/2
E984

INTERIOR DOOR JAMB

Interior Door Jamb

Kerfing for bullnose is available on all jamb sizes and species. Custom size odd wall widths available upon request.

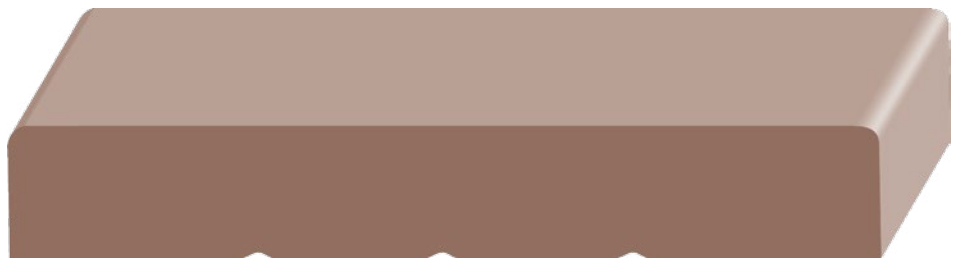

Specifications:

11/16" Thick
6/8 = 81" Below Dado
8/0 = 97" Below Dado

- Lineal - 17' = MDF, FJ Pine & Oak Veneer
- Solid Pine jambs may have a glue line where door stop is applied.
- Random Lengths only available in most solid wood species
- Dado depth = 3/8"
- Heads cut 3/4 over opening
- 5 pair per bundle

SIZE	6/8	8/0
4-9/16	4916SPI6	4916SPI8
4-3/4	434SPI6	434SPI8
5-1/4	514SPI6	514SPI8
7-1/4	714SPI6	714SPI8

Raw & Primed **FJ Pine**

THE ECONOMICAL CHOICE FOR PAINTED WOOD



Inside

Apron.....	55
Astragal.....	53
Base & Base Shoe.....	39-48
Casing.....	33-38
Chair Rail.....	51
Cleat.....	54
Cove.....	50
Crown & Cornice.....	47-50
Door Header & Skirt.....	38
Exterior Door Jambs & Frames.....	57-59
Exterior Molds.....	55
Full Round.....	50
Hook.....	54
Interior Door Jambs.....	56
Panel Mold & Panel Cap.....	53
Quarter Round.....	50
S1S & S4S (non-protected).....	56
Stool.....	54
Stop.....	46
T&G Wainscot.....	52



Raw & Primed **FJ Pine**

THE ECONOMICAL CHOICE FOR PAINTED WOOD

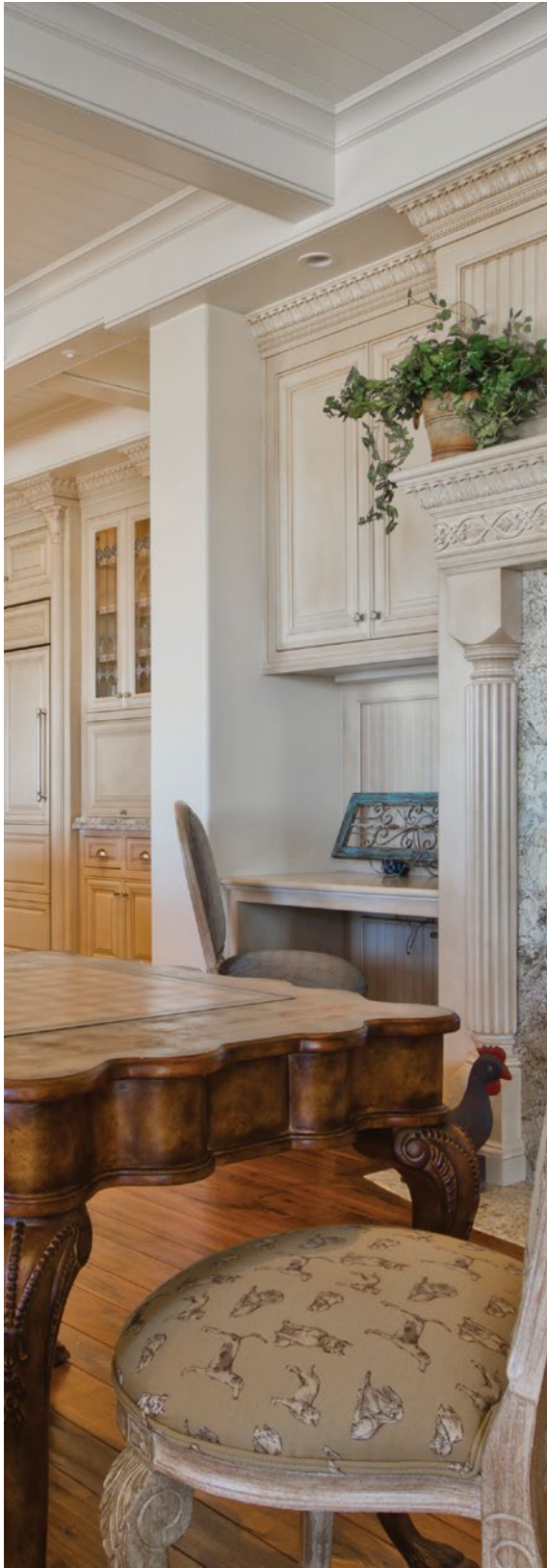

Finger-Joint (FJ) Pine consists of small pieces of wood that are recycled and jointed together to create lengths for door casings and 16' or 17' lengths for crowns, base and chair rails. This allows for ease of installation and less installation joints, typical of solid woods.

The advantages to FJ Pine mouldings are the definition of detail, much sharper than MDF, the workability, nailing ease and personal preference for wood.

Primed FJ moulding is coated with a water-based primer on four sides and fully protected from the elements. Each piece of moulding is ready for paint once prepping is complete. With the same properties as Raw FJ, Primed FJ millwork is receptive to paint, saving extra time and the cost of priming.

All FJ & Primed FJ mouldings have trimbacks. Trimbacks occur during manufacturing when the moulding comes through the molder at the correct long length, but a defect is spotted. Rather than throw the whole piece of moulding away, the defect is cut out, leaving varied lengths. Trimbacks (lengths other than those ordered) should not exceed 10% of the footage ordered.

ALL STYLES IN-STOCK

STANDARD WITH TRIMBACKS

LONG LENGTHS

(items are approximate scale only)

9/16" to 2-1/2" CASING

Lengths Available: 7' thru 17' with Trimbacks

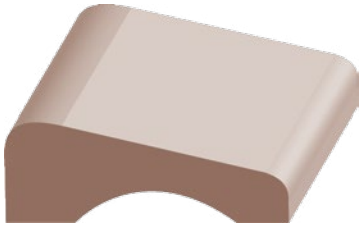

Pre-Fit Casing 9/16 x 1-1/2
151A

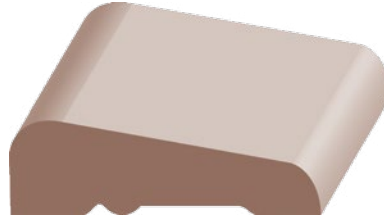

Flat Streamline Casing 1/2 x 1-5/8
101A

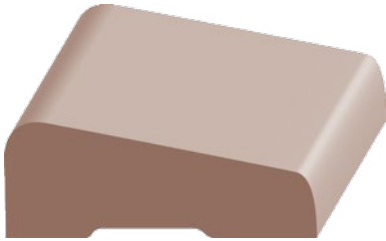

Flat Streamline Casing 5/8 x 1-5/8
102A

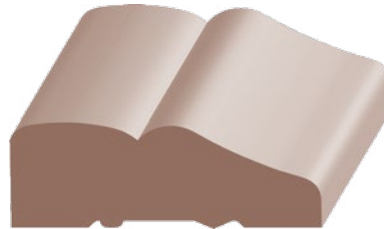

#711 Casing 5/8 x 1-5/8
107A

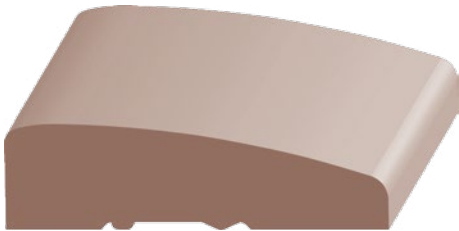

Clamshell Casing 11/16 x 2
121A

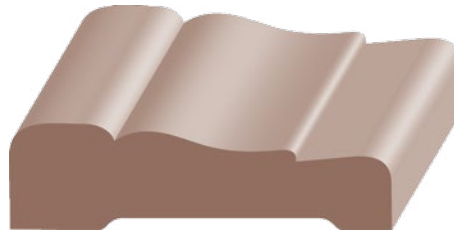

#356 Casing 9/16 x 2
153A

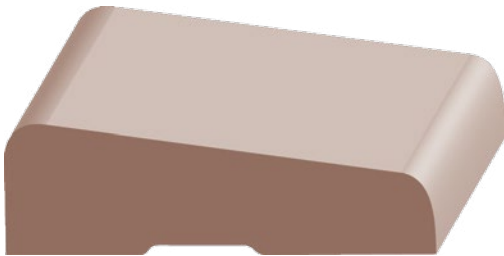

Flat Streamline Casing 11/16 x 2-1/4
103A

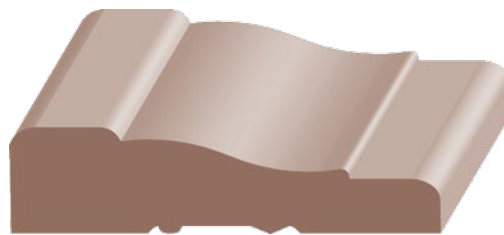

#356 Casing 11/16 x 2-1/4
PR152A Primed
152A

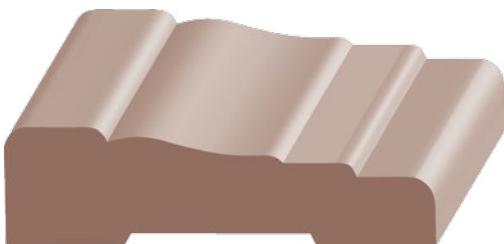

#366 Casing 11/16 x 2-1/4
162A



#711 Casing 5/8 x 2-1/2
PR108A Primed
108A



2-1/2" CASING

Lengths Available: 7' thru 17' with Trimbacks

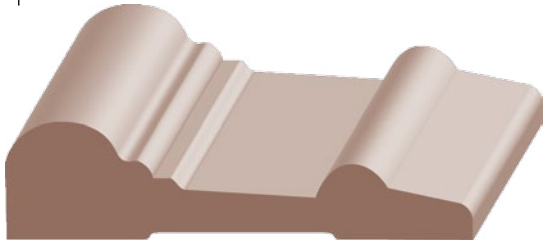

Universal Casing 5/8 x 2-1/2
115A

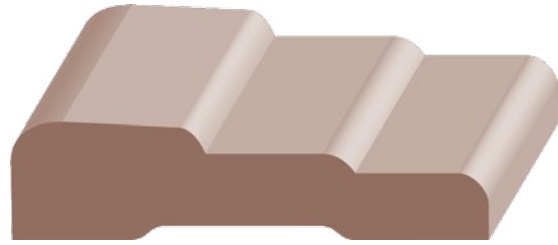

3-Step Casing 5/8 x 2-1/2
110A

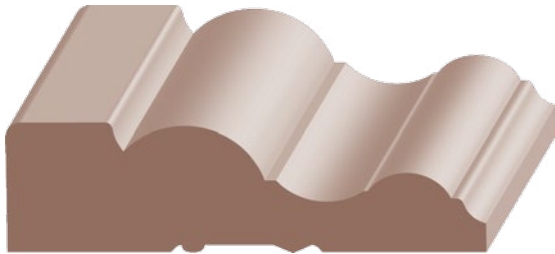

Bel-Air Casing 11/16 x 2-1/2
PR128A Primed
128A

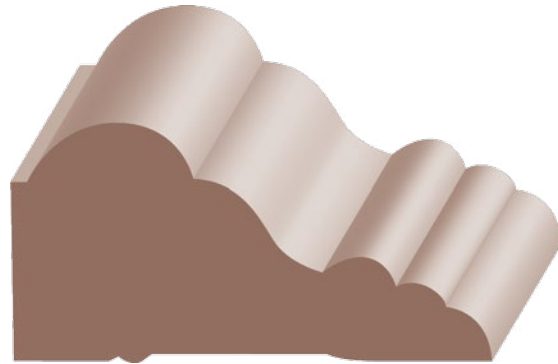

Coronado Casing 1-1/4 x 2-1/2
PR157A Primed
157A

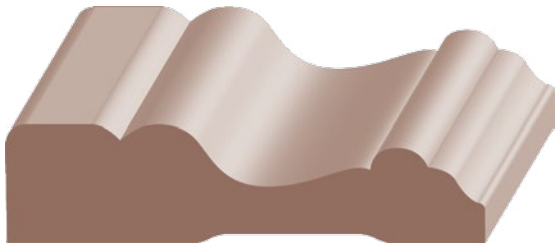

Cape Cod Casing 5/8 x 2-1/2
PR150A Primed
150A

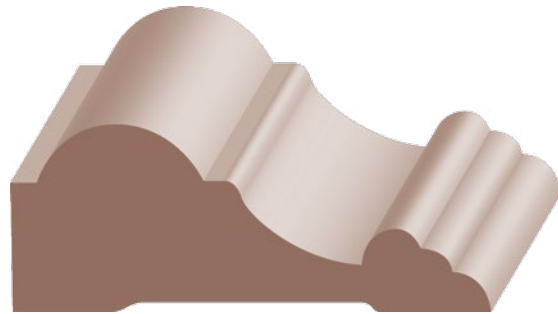

Hermosa Casing 1 x 2-1/2
PR159A Primed
159A

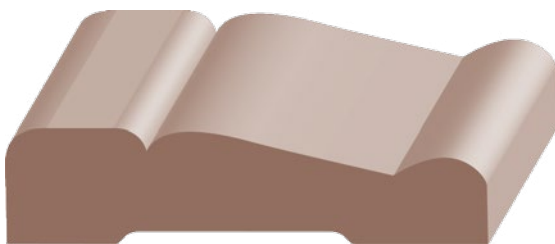

Monterey Casing 5/8 x 2-1/2
PR163A Primed
163A



Bell Court Casing 1-1/4 x 2-1/2
164A

(items are approximate scale only)

2-1/2" to 3" CASING

Lengths Available: 7' thru 17' with Trimbacks

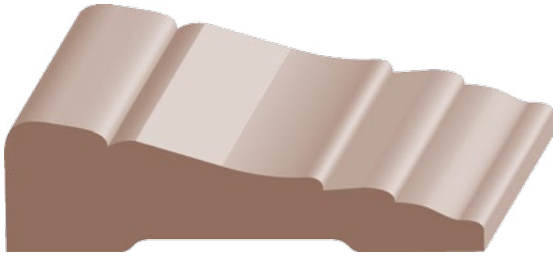

#366 Casing 11/16 x 2-1/2
162B

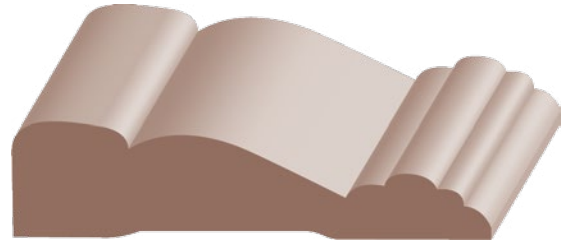

Tudor Casing 11/16 x 2-1/2
169A

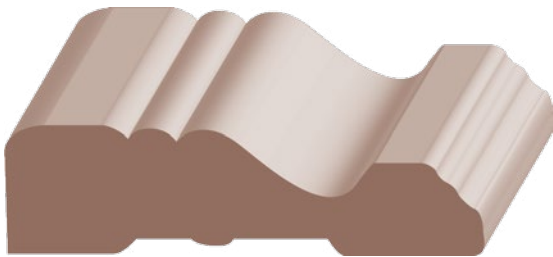

Palisade Casing 11/16 x 2-1/2
PR182A Primed

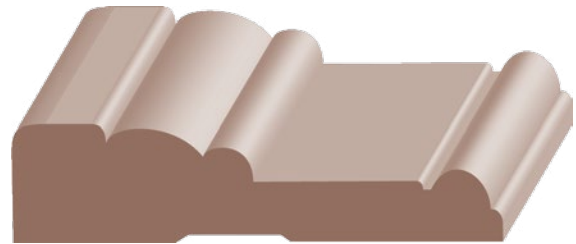

Montecito Casing 5/8 x 2-9/16
PR123A Primed

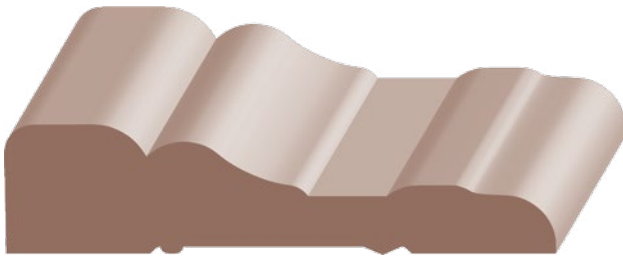

Colonial Casing 11/16 x 2-7/8
PR119A 119A Primed



#275 Casing 11/16 x 2-7/8
PR124A Primed

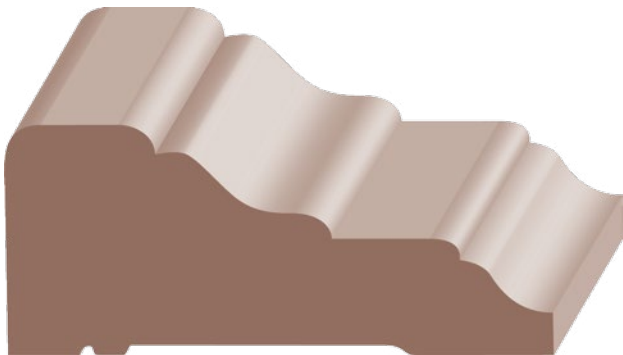

Palos Verdes Casing 1-3/16 x 2-7/8
167A

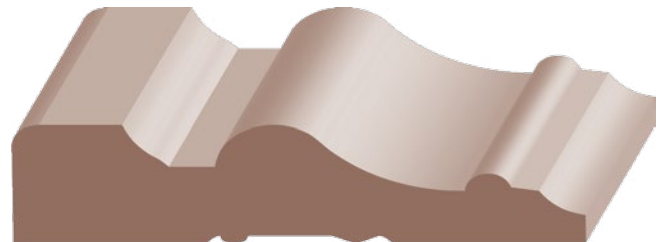

#275 Casing 5/8 x 3
165A



3" to 3-1/2" CASING

Lengths Available: 7' thru 17' with Trimbacks

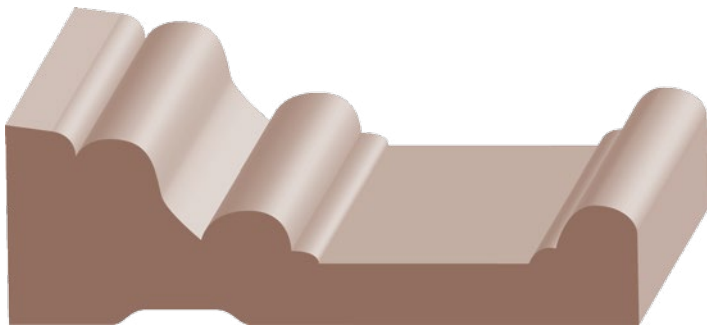

Howe Casing 11/16 x 3
PR177A Primed

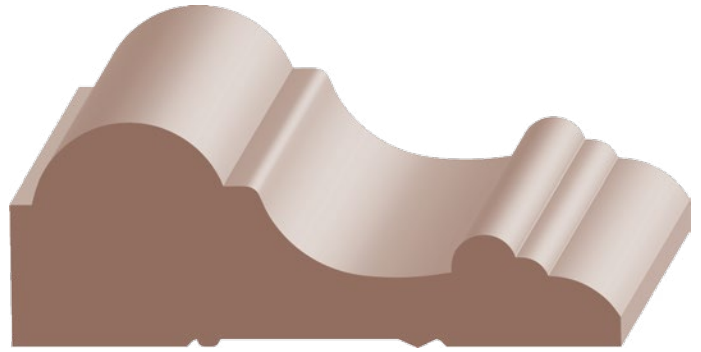

Hermosa Casing 1-1/4 x 3-1/4
160A

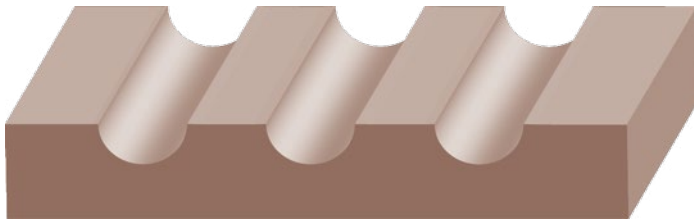

3-Flute Casing
(not reversible) 1/2 x 3-1/4
154A

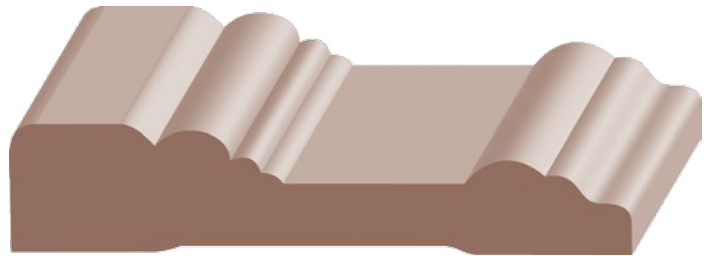

Crescent Casing 11/16 x 3-1/4
126A

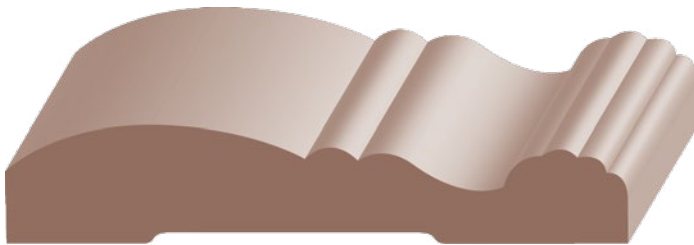

Cambridge Casing 5/8 x 3-1/4
161A

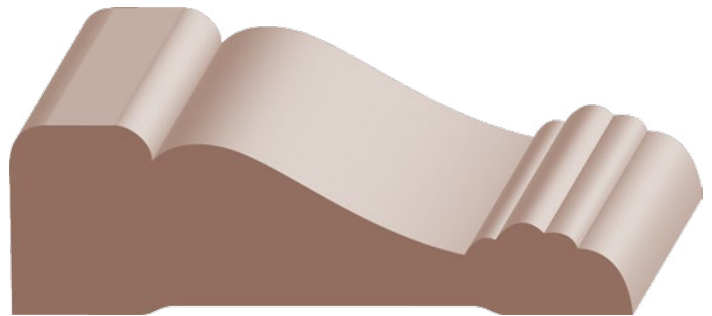

Tudor Casing 1 x 3-1/4
170A

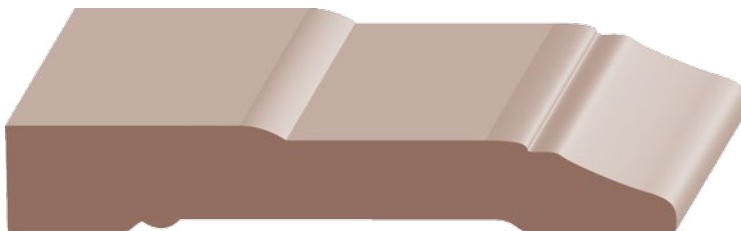

Colonial Casing 9/16 x 3-1/2
117A

3-1/2" to 3-9/16" CASING

Lengths Available: 7' thru 17' with Trimbacks

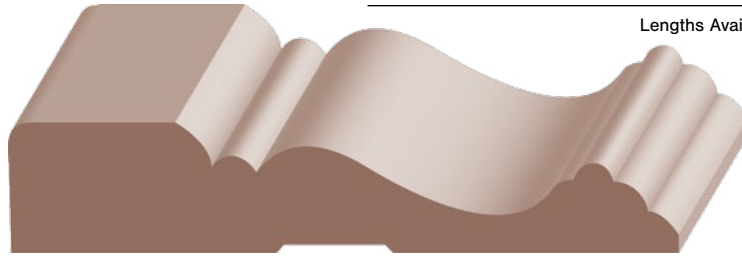

Cape Cod Casing 11/16 x 3-1/2
155A

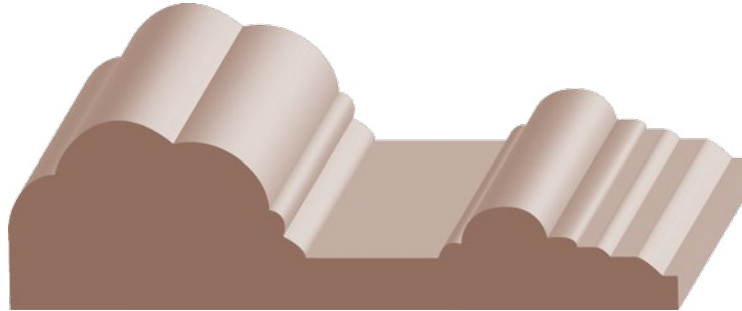

Crescent Casing 1 x 3-1/2
166A

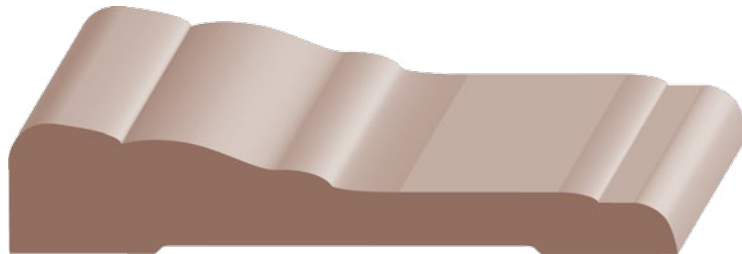

Chesapeake Casing 11/16 x 3-1/2
156A

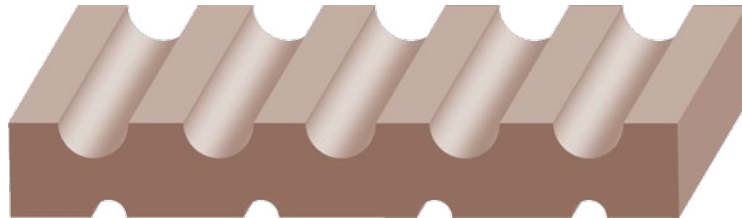

5-Flute Casing 1/2 x 3-1/2
158A

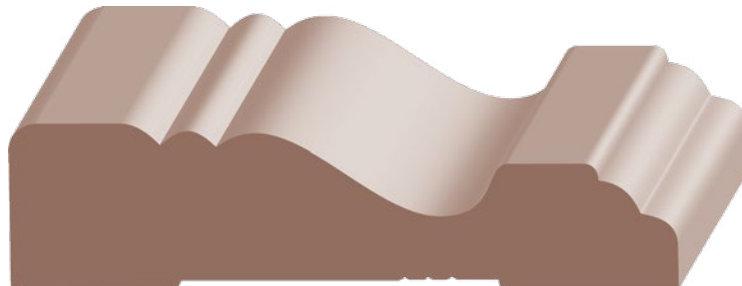

Palisade Casing 13/16 x 3-9/16
PR185A Primed



4" to 5-1/2" CASING

Lengths Available: 7' thru 17' with Trimbacks



**2 Eased Edge
Craftsman Casing** 11/16 x 4
PR186A Primed

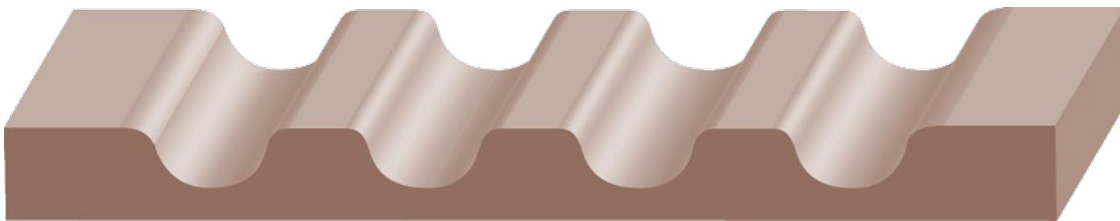

4-Flute Casing 1/2 x 5-1/2
172A

DOOR HEADER SKIRT

Lengths Available: 17' with Trimbacks

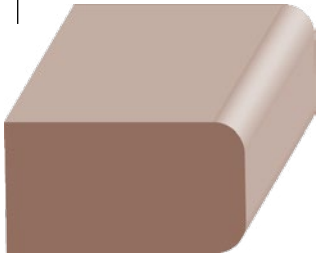

**2 Eased Edge
Header Skirt** 11/16 x 1-1/4
PR970A Primed

DOOR HEADER

Lengths Available: 16' with Trimbacks

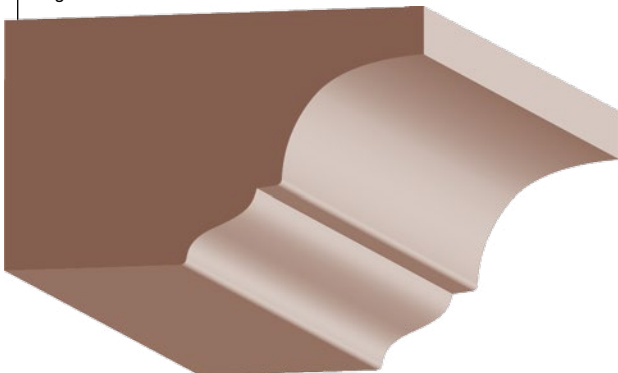

Craftsman Door Header 1-3/4 x 2-1/4
PRDH150A Primed

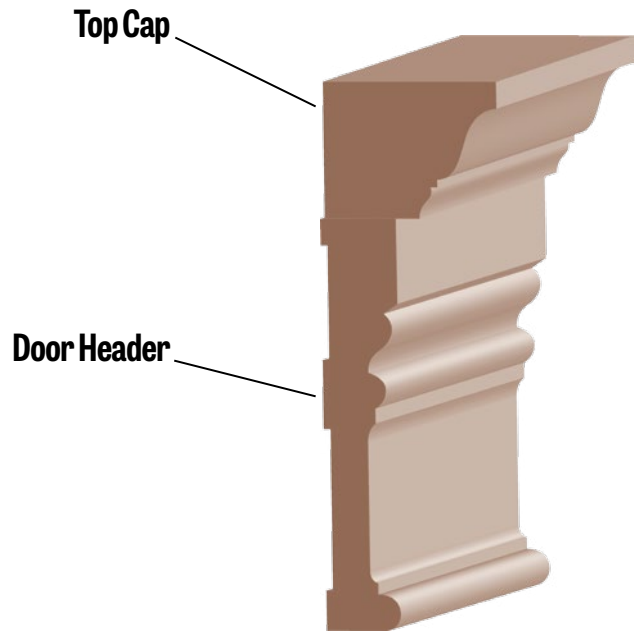

(items are approximate scale only)

3/4" to 2-1/2" BASE & BASE SHOE

Lengths Available: 16' with Trimbacks

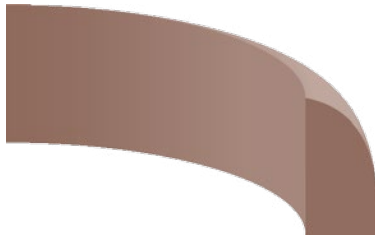

Base Shoe Corner

300AW 3/8 x 3/4
PR300BW 1/2 x 3/4
(Primed)

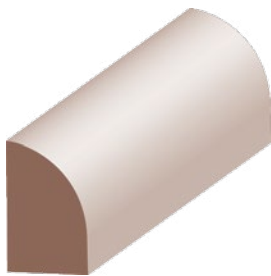

Base Shoe 3/8 x 3/4
PR300A Primed
300A

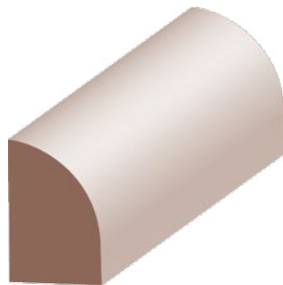

Base Shoe 1/2 x 3/4
PR300B Primed

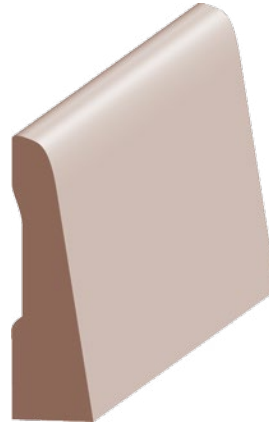

Flat Base 7/16 x 1-1/2
301A

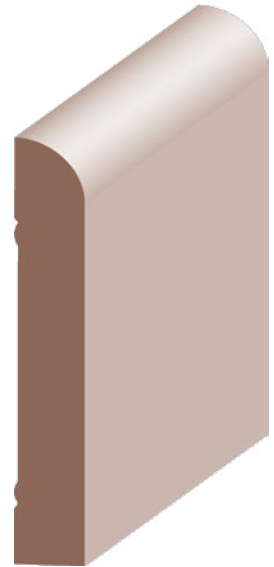

Streamline Base 3/8 x 2-1/4
304A

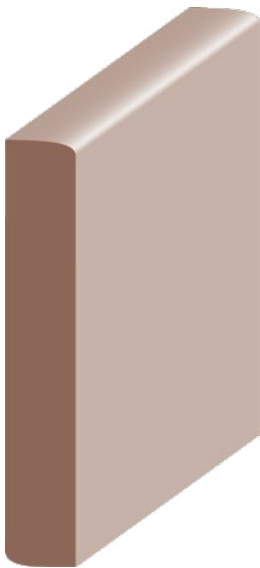

Reversible Shoe 3/8 x 2-1/4
PR304FJ-2 Primed



#711 Base 7/16 x 2-1/2
PR310A Primed
310A



#711 Base 5/8 x 2-1/2
310B

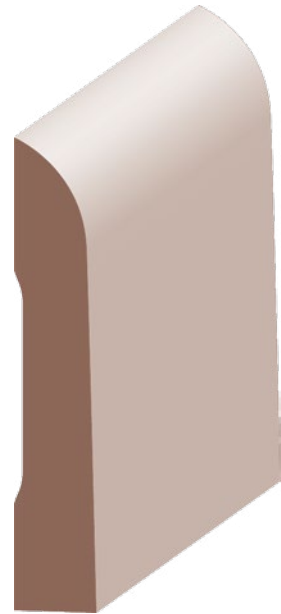

Streamline Base 7/16 x 2-1/2
305A

*Trimbacks are lengths other than standard. When a defect occurs during milling, the defect is removed leaving a length other than ordered. Trimbacks are considered any length 6' thru 15' and may represent up to 15% of a tally with 85% in the stocked length requested.



2-1/2" to 3-1/2" BASE

Lengths Available: 16' with Trimbacks

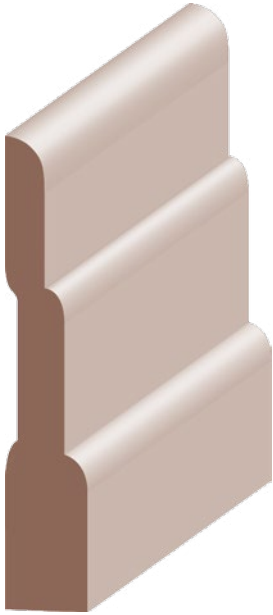

3-Step Base 7/16 x 2-1/2
312A

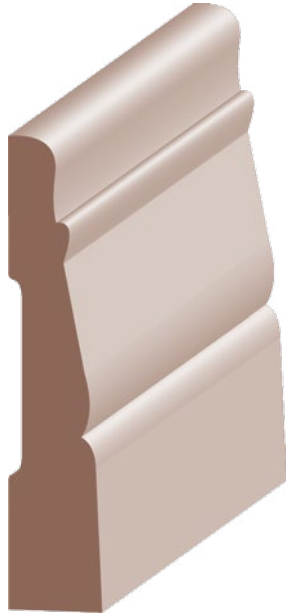

#356 Base 1/2 x 2-1/2
319A



#356 Base 7/16 x 3-1/4
PR320A Primed
320A

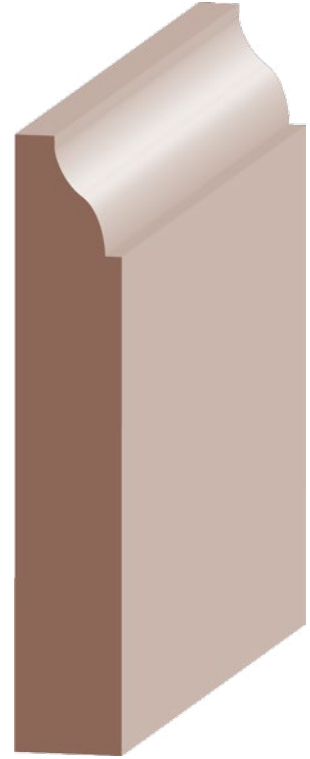

#623 Base 9/16 x 3-1/4
314A

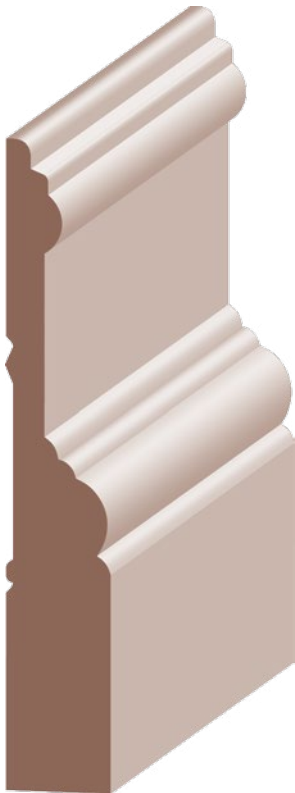

3-Crescent Base 9/16 x 3-7/16
339A

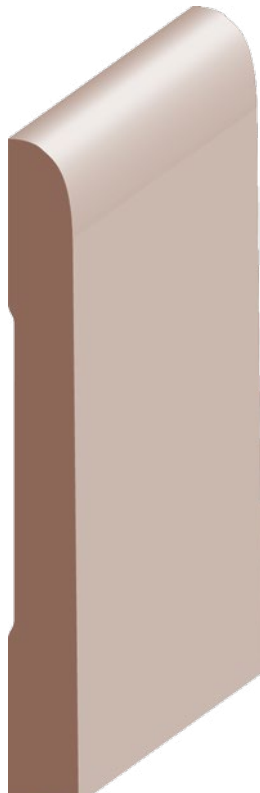

Streamline Base 7/16 x 3-1/2
307A



#711 Base 7/16 x 3-1/2
PR311A Primed
311A

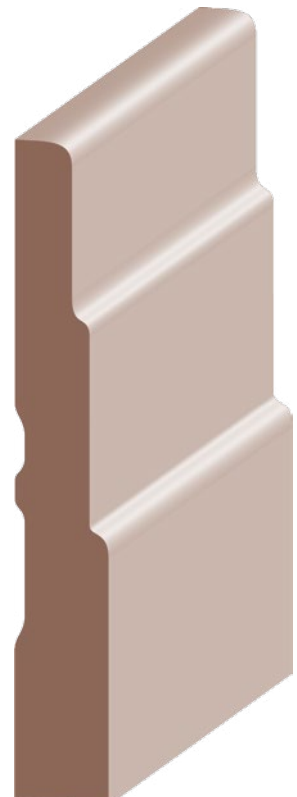

3-Step Base 1/2 x 3-1/2
322A

(items are approximate scale only)

3-1/2" BASE

Lengths Available: 16' with Trimbacks

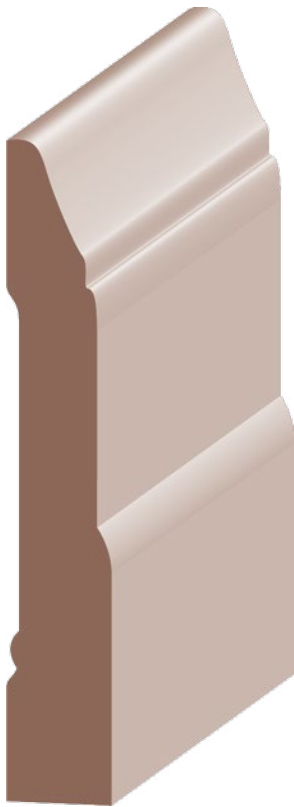

Colonial Base 9/16 x 3-1/2
117A

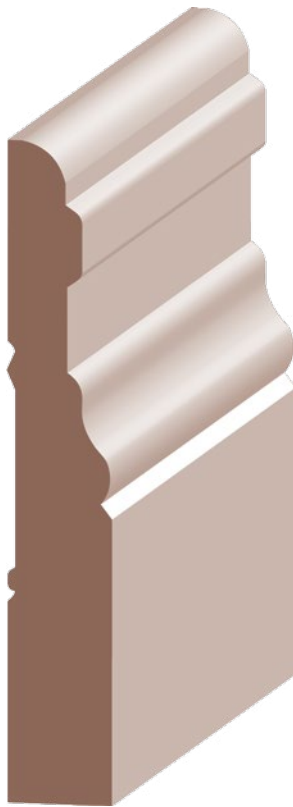

Colonial Base 9/16 x 3-1/2
PR118A-3 Primed

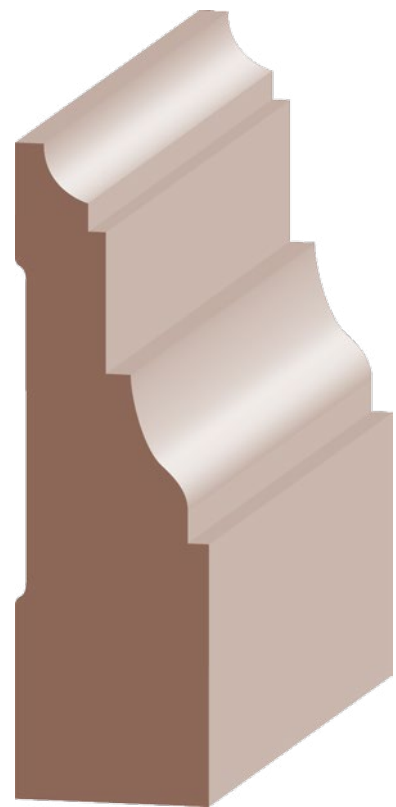

Palos Verdes Base 1 x 3-1/2
327A

*Trimbacks are lengths other than standard. When a defect occurs during milling, the defect is removed leaving a length other than ordered. Trimbacks are considered any length 6' thru 15' and may represent up to 15% of a tally with 85% in the stocked length requested.



3 -3/4" to 4-1/4" BASE

Lengths Available: 16' with Trimbacks

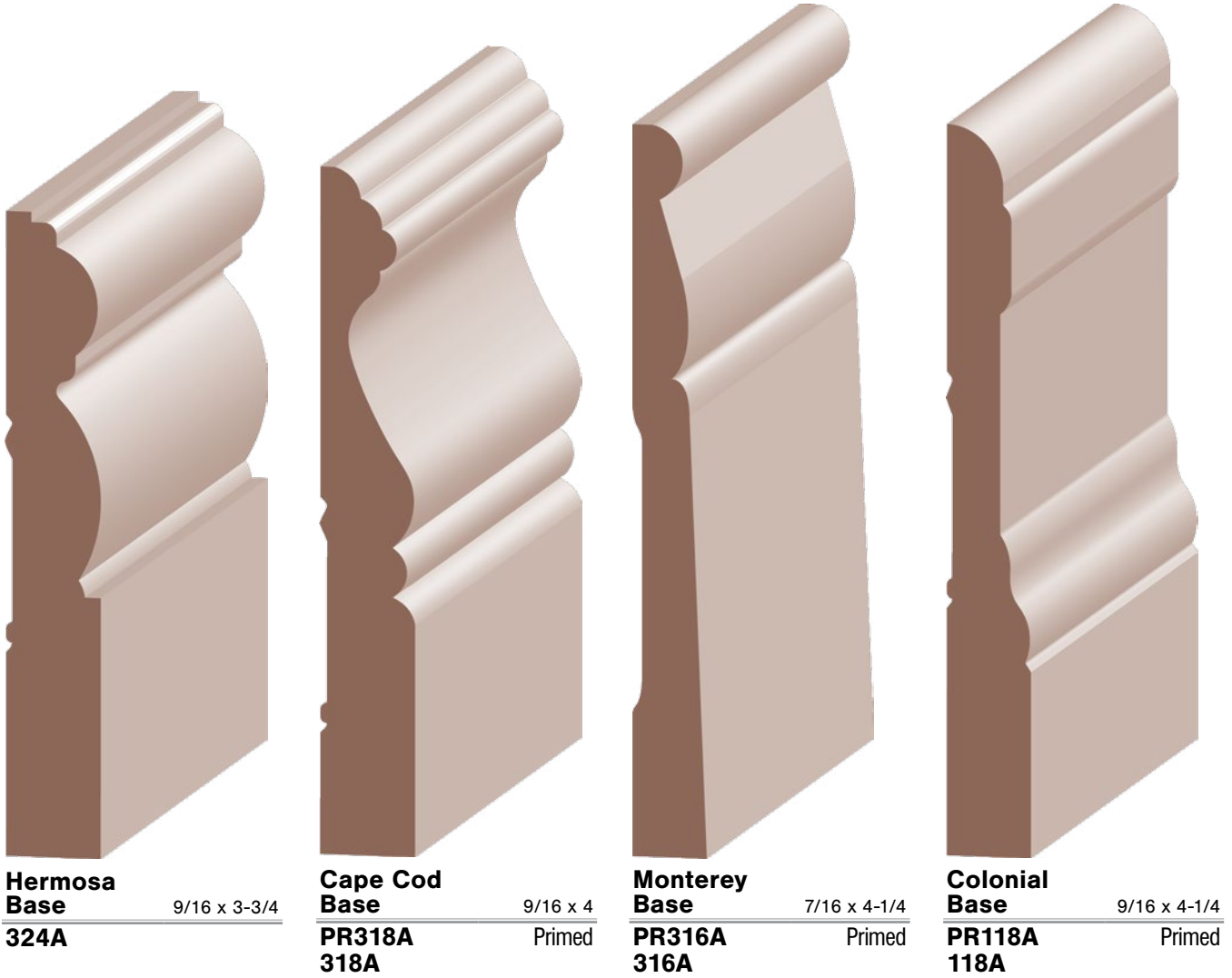

*Trimbacks are lengths other than standard. When a defect occurs during milling, the defect is removed leaving a length other than ordered. Trimbacks are considered any length 6' thru 15' and may represent up to 15% of a tally with 85% in the stocked length requested.

(items are approximate scale only)

4-1/4" to 4-1/2" BASE

Lengths Available: 16' with Trimbacks

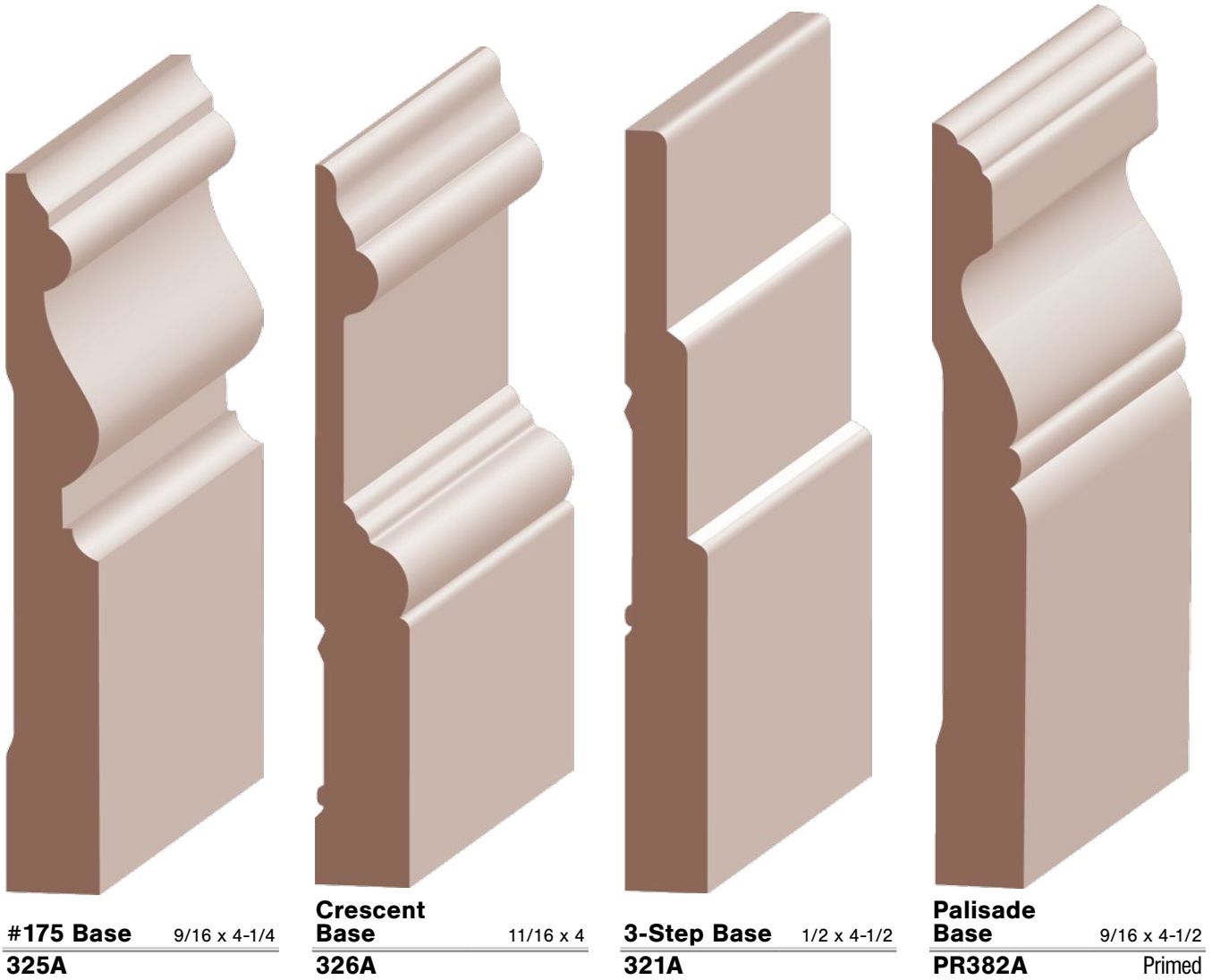

*Trimbacks are lengths other than standard. When a defect occurs during milling, the defect is removed leaving a length other than ordered. Trimbacks are considered any length 6' thru 15' and may represent up to 15% of a tally with 85% in the stocked length requested.



5" to 5-1/4" BASE

Lengths Available: 16' with Trimbacks



Hermosa Base 9/16 x 5
323A



Montecito Base 9/16 x 5
PR323A Primed
323A

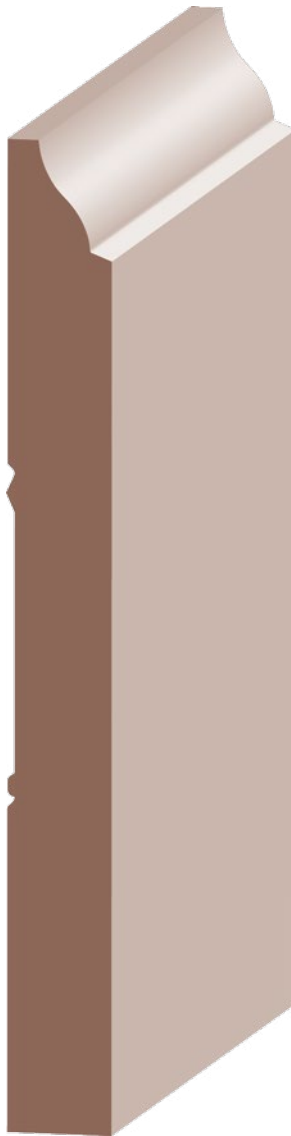

#618 Base 9/16 x 5-1/4
315A

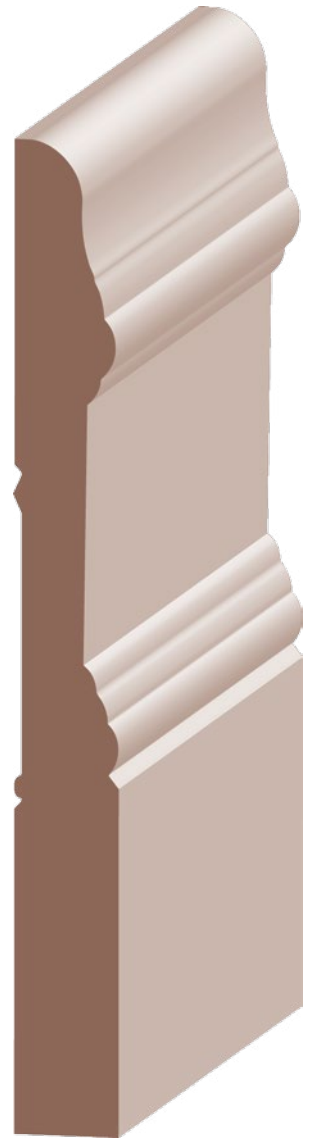

Crescent Base 9/16 x 5-1/4
317A

*Trimbacks are lengths other than standard. When a defect occurs during milling, the defect is removed leaving a length other than ordered. Trimbacks are considered any length 6' thru 15' and may represent up to 15% of a tally with 85% in the stocked length requested.

(items are approximate scale only)

5-1/4" to 5-3/8" BASE

Lengths Available: 16' with Trimbacks



**"B" Cape
Cod Base** 9/16 x 5-1/4
318B

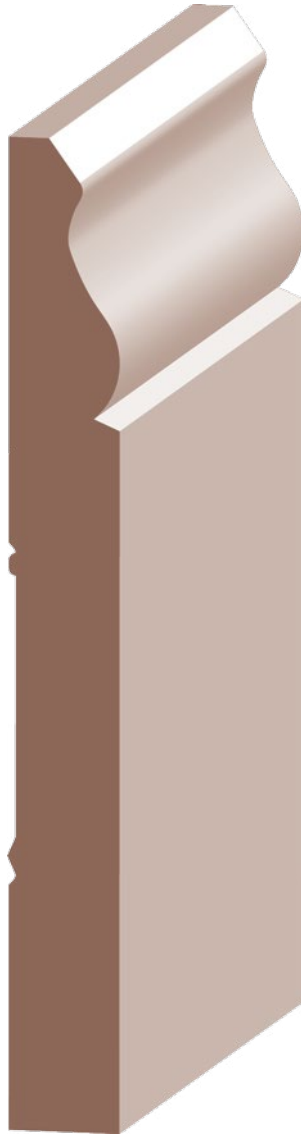

**Colonial
Base** 9/16 x 5-1/4
328A

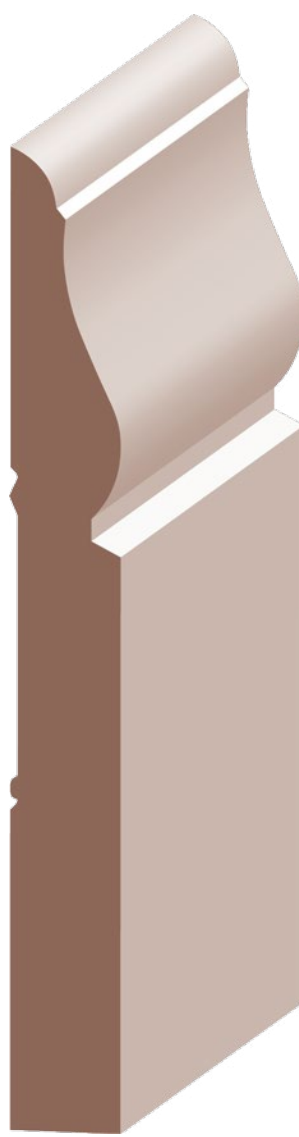

**Lancaster
Base** 5/8 x 5-1/4
365A

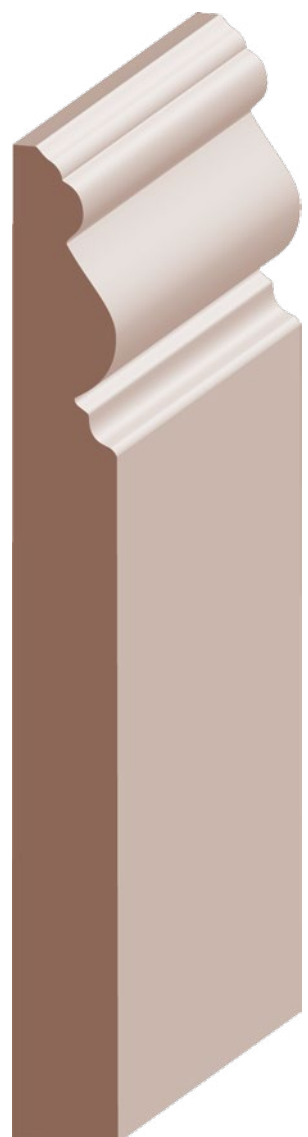

#175 Base 9/16 x 5-7/16
PR338A Primed
338A

*Trimbacks are lengths other than standard. When a defect occurs during milling, the defect is removed leaving a length other than ordered. Trimbacks are considered any length 6' thru 15' and may represent up to 15% of a tally with 85% in the stocked length requested.



6" BASE

Lengths Available: 16' with Trimbacks

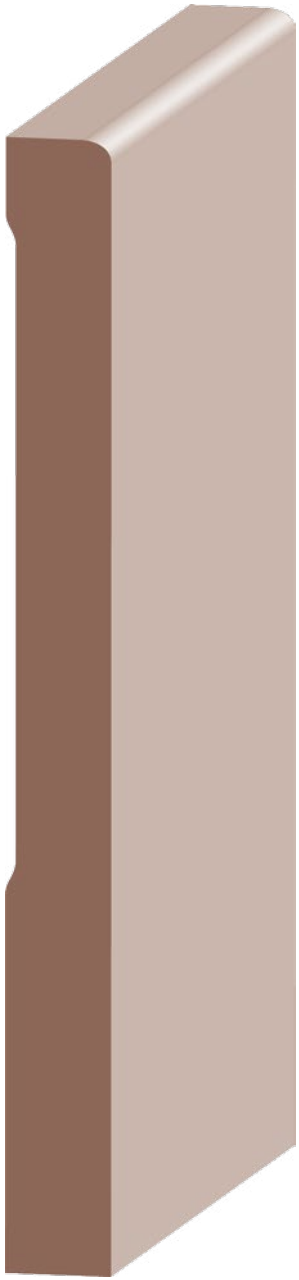

**1 Eased Edge
Craftsman
Base** 9/16 x 6
PR383A Primed

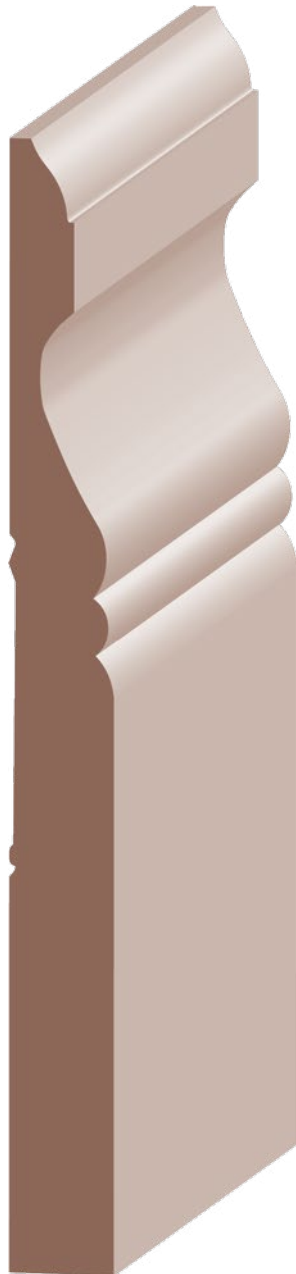

**Palisade
Base** 9/16 x 6
PR385A Primed

STOP

Lengths Available: 7' thru 17' with Trimbacks



**2 Round
Edge Stop** 3/8 x 1-1/4
202A

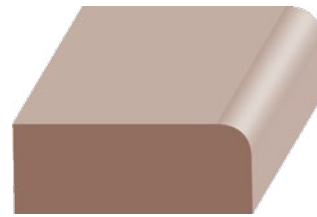

**1 Round
Edge Stop** 1/2 x 1-1/4
206A



Vinyl Stop
[Length Available: 7'] 1/2 x 1-1/2
211A



Ogee Stop 1/2 x 1-3/4
210A



**1 Round
Edge Stop** 1/2 x 1-1/2
PR209A Primed
209A

*Trimbacks are lengths other than standard. When a defect occurs during milling, the defect is removed leaving a length other than ordered. Trimbacks are considered any length 6' thru 15' and may represent up to 15% of a tally with 85% in the stocked length requested.

(items are approximate scale only)

2-1/2" to 3-1/4" CROWN & CORNICE

Lengths Available: 16' with Trimbacks

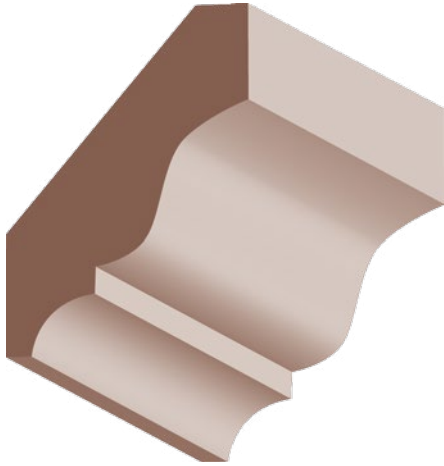

Colonial Crown 9/16 x 2-1/2
401A

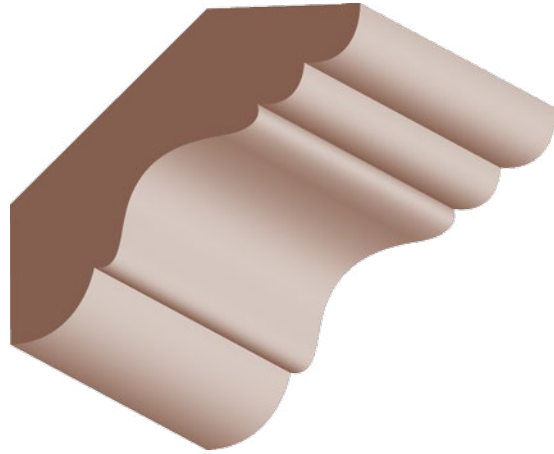

Cornice 11/16 x 2-1/2
402A

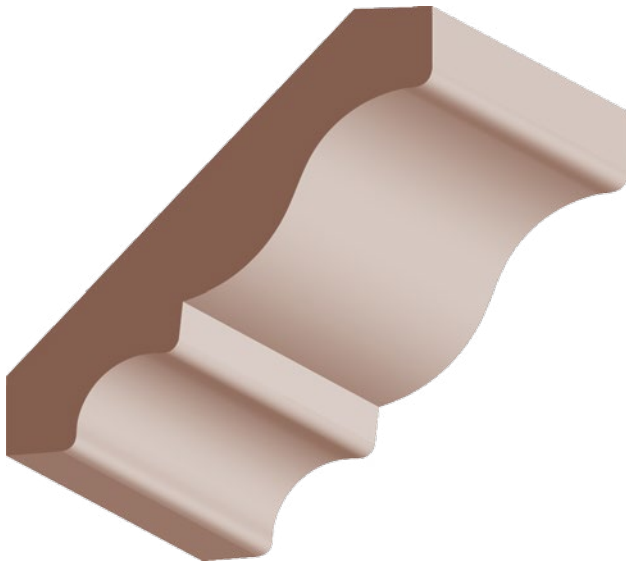

Colonial Crown 9/16 x 3-3/8
PR405A Primed
405A

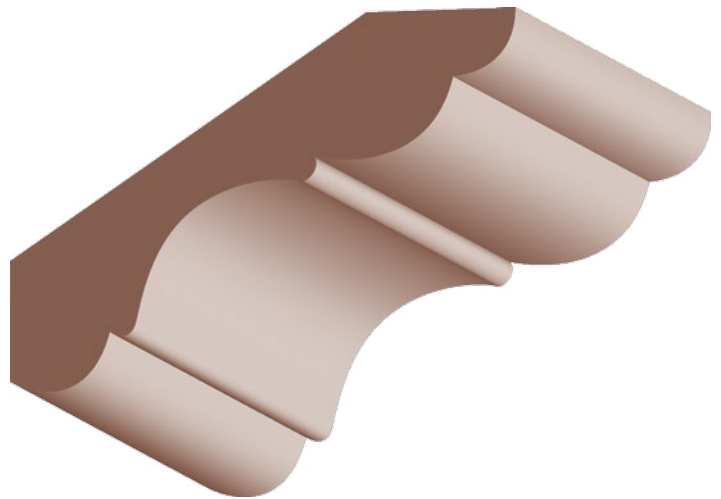

Cornice 11/16 x 3-1/4
413A

*Trimbacks are lengths other than standard. When a defect occurs during milling, the defect is removed leaving a length other than ordered. Trimbacks are considered any length 6' thru 15' and may represent up to 15% of a tally with 85% in the stocked length requested.



2-1/4" to 3-3/8" CROWN & CORNICE

Lengths Available: 16' with Trimbacks

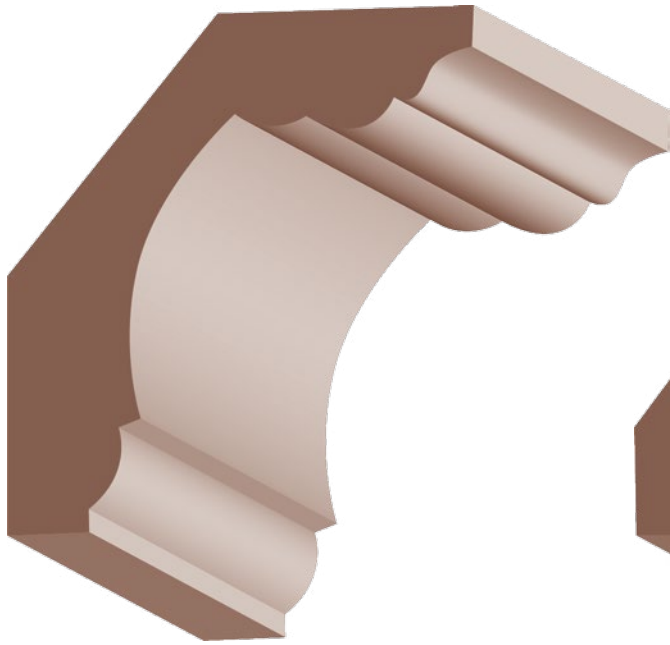

Cornice 1-1/4 x 3-9/16
411A

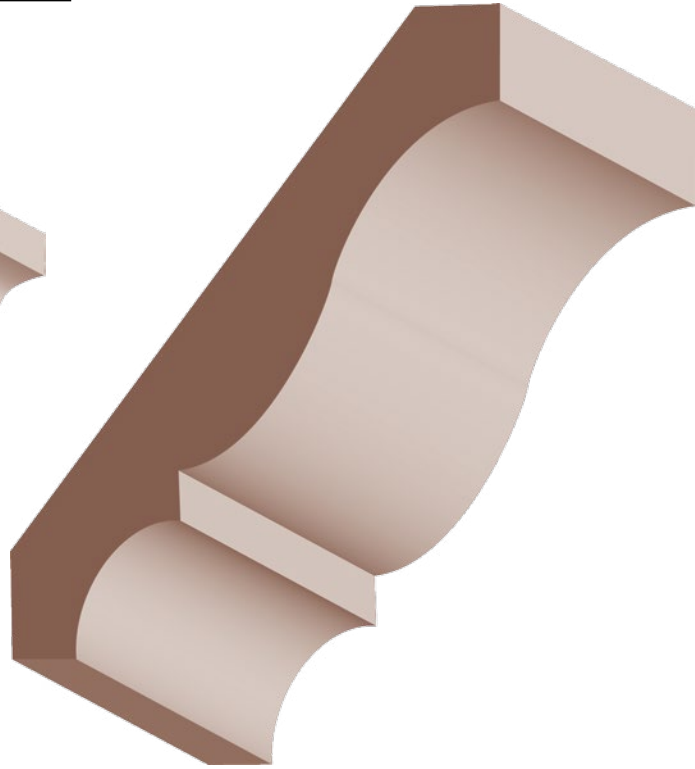

Colonial Crown 9/16 x 4-3/8
PR406A Primed
406A

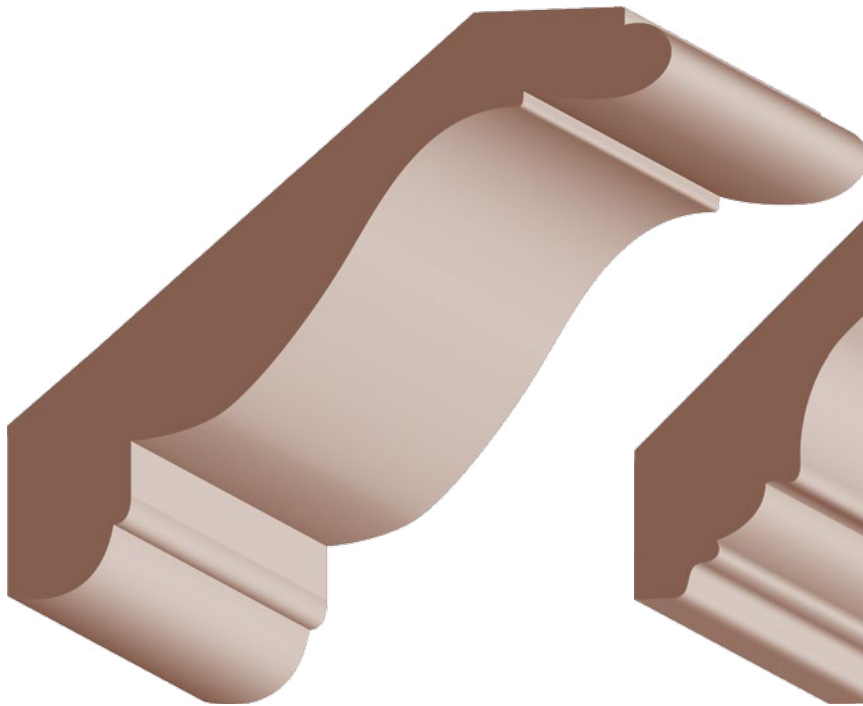

Cornice 11/16 x 4-5/8
409A

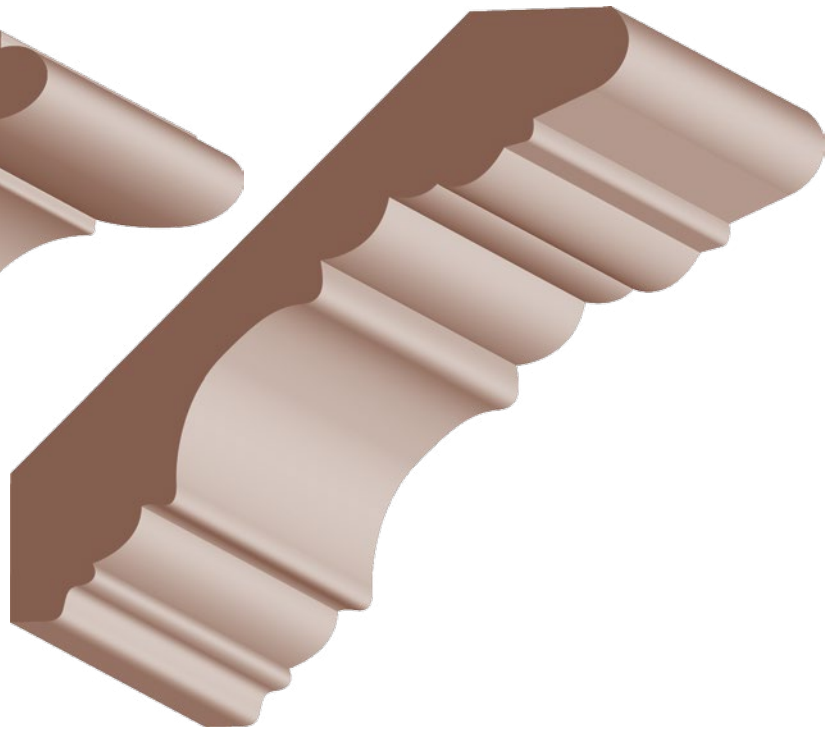

Georgian Crown 11/16 x 4-1/4
412A

*Trimbacks are lengths other than standard. When a defect occurs during milling, the defect is removed leaving a length other than ordered. Trimbacks are considered any length 6" thru 15" and may represent up to 15% of a tally with 85% in the stocked length requested.

(items are approximate scale only)

5-1/4" to 5-3/4" CROWN & CORNICE

Lengths Available: 16' with Trimbacks

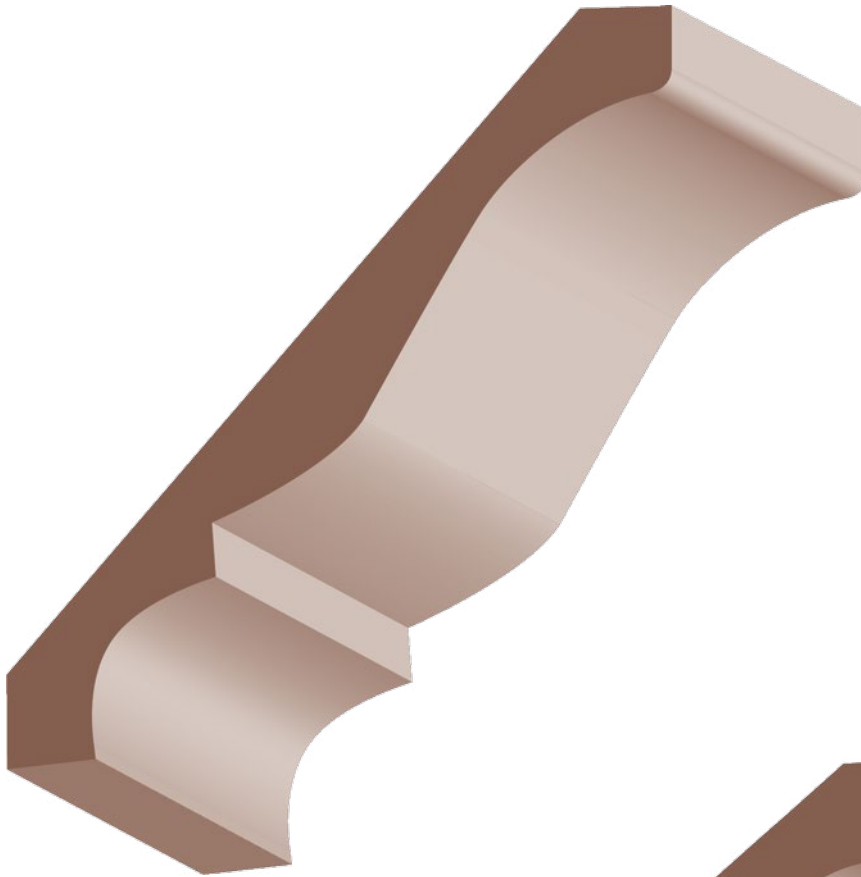

Colonial Crown 9/16 x 5-1/4
PR414A Primed
414A

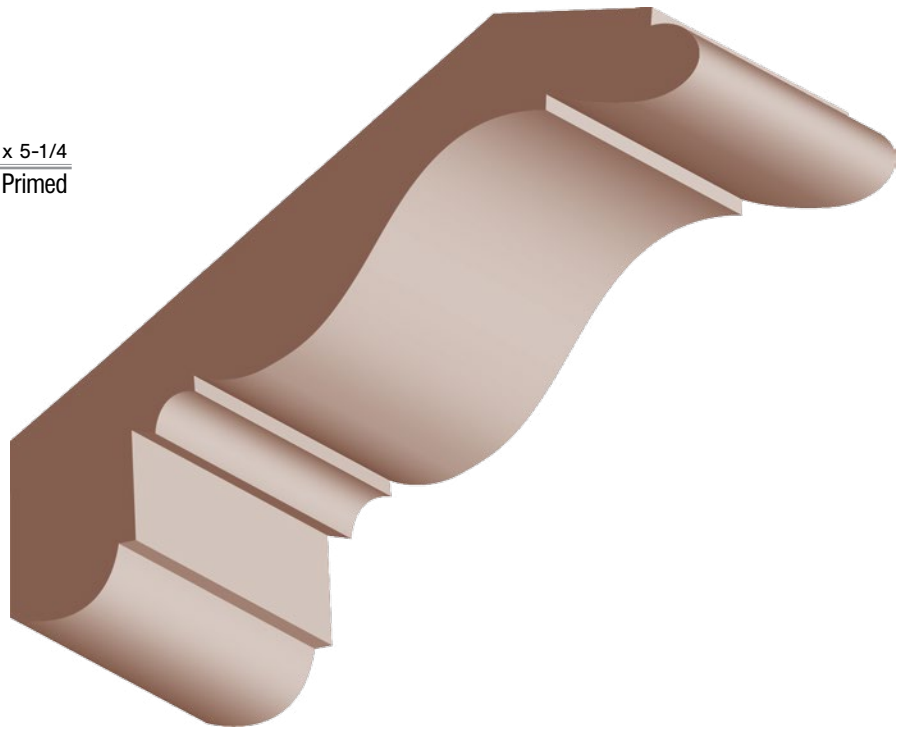

Cornice 1-1/4 x 5-3/4
408A

*Trimbacks are lengths other than standard. When a defect occurs during milling, the defect is removed leaving a length other than ordered. Trimbacks are considered any length 6' thru 15' and may represent up to 15% of a tally with 85% in the stocked length requested.



6" CROWN & CORNICE

Lengths Available: 16' with Trimbacks

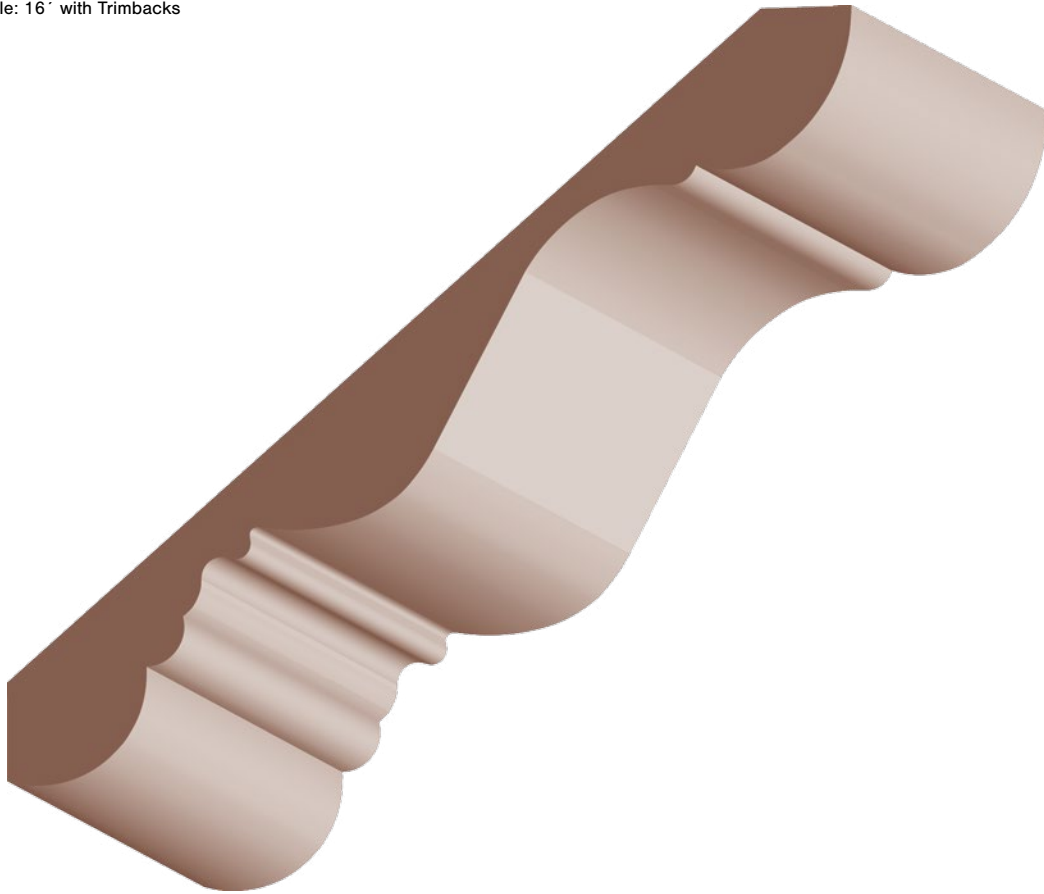

Crown 5/8 x 6
410A

COVE & ROUNDS

Lengths Available: 16' with Trimbacks

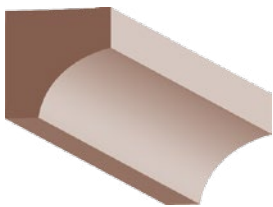

Cove 11/16 x 11/16
523A

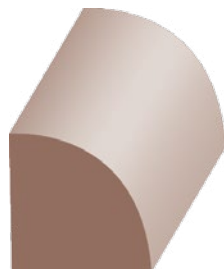

Quarter Round
504A 11/16 x 11/16
PR504A (Primed) 3/4 x 3/4

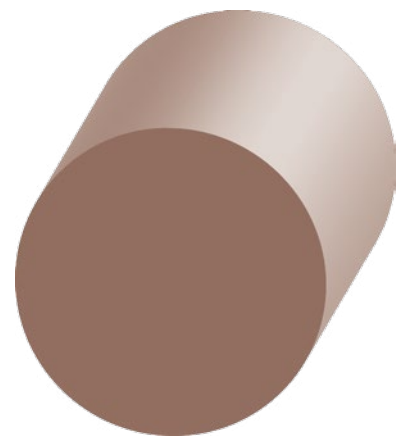

Full Round 1-5/16
[Lengths Available: 6'-16']
802A

*Trimbacks are lengths other than standard. When a defect occurs during milling, the defect is removed leaving a length other than ordered. Trimbacks are considered any length 6' thru 15' and may represent up to 15% of a tally with 85% in the stocked length requested.

(items are approximate scale only)

CHAIR RAIL

Lengths Available: 16' with Trimbacks

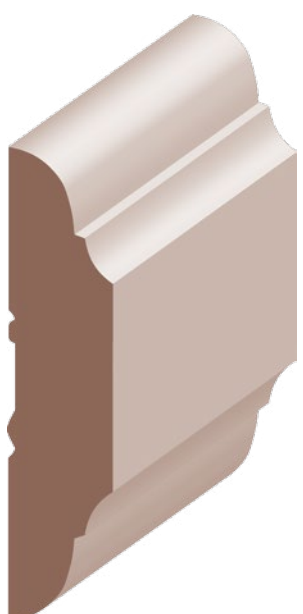

Chair Rail 9/16 x 2-1/2
PR651A Primed
651A



Bead & Barrel Chair Rail 11/16 x 3
649A

Beaded Chair Rail 11/16 x 3-1/4
PR655A Primed
(Use alone or w/ PR671A for a larger look)

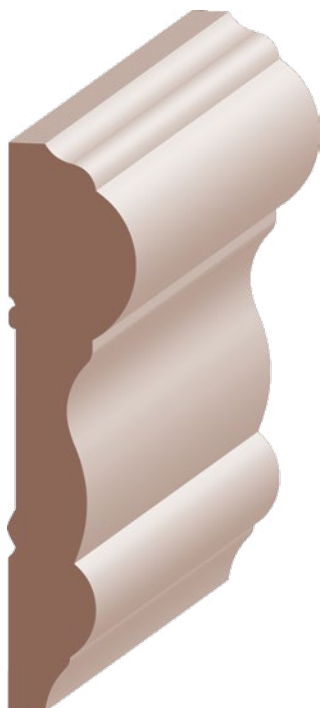
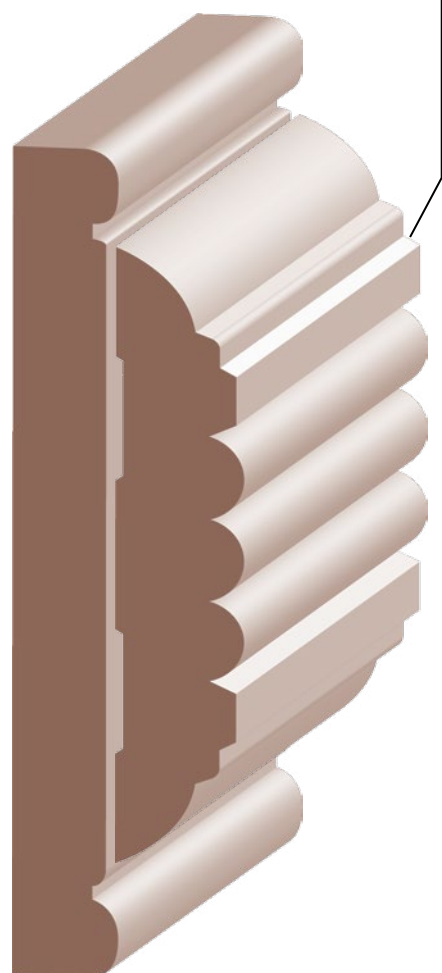

Colonial Chair Rail 11/16 x 3
653A

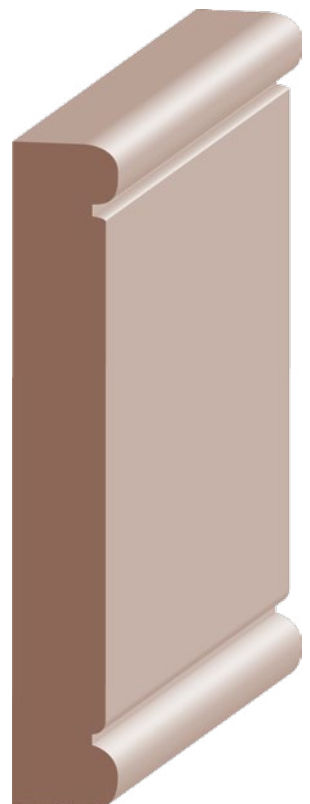

Chair Rail Backer 9/16 x 3-1/2
PR670A Primed

Chair Rail Backer 9/16 x 4-3/8
PR671A Primed

*Trimbacks are lengths other than standard. When a defect occurs during milling, the defect is removed leaving a length other than ordered. Trimbacks are considered any length 6' thru 15' and may represent up to 15% of a tally with 85% in the stocked length requested.



T&G WAINSCOT

Lengths Available: 16' with Trimbacks



Flat T&G Wainscot 3/8 x 3-1/4
2001A



Beaded T&G Wainscot 3/8 x 3-3/8
2000A

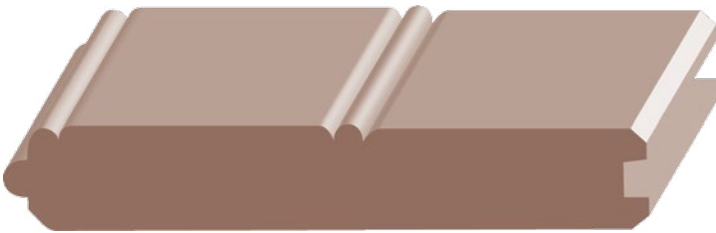

Beaded T&G Wainscot 9/16 x 3-3/8
PR2000A Primed

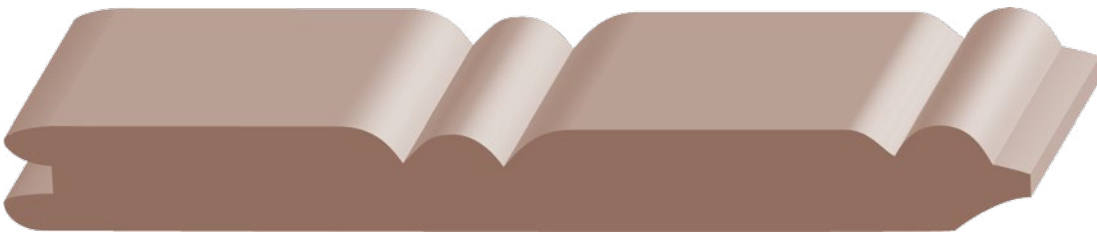

Beaded T&G Wainscot 9/16 x 5-3/8
PR2002A Primed



Untreated V-Groove T&G Wainscot 5/8 x 5-1/2
PR2003A Primed

*Trimbacks are lengths other than standard. When a defect occurs during milling, the defect is removed leaving a length other than ordered. Trimbacks are considered any length 6' thru 15' and may represent up to 15% of a tally with 85% in the stocked length requested.

(items are approximate scale only)

PANEL MOLDS & PANEL CAPS

Lengths Available: 16' with Trimbacks

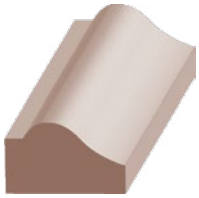

Panel Mold 3/4 x 1
PR602A Primed

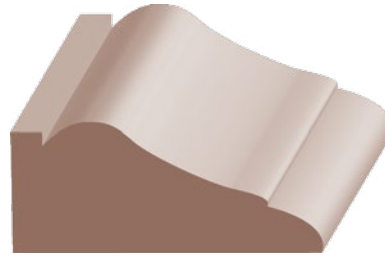

Panel Mold 11/16 x 1-5/8
PR605A Primed
605A

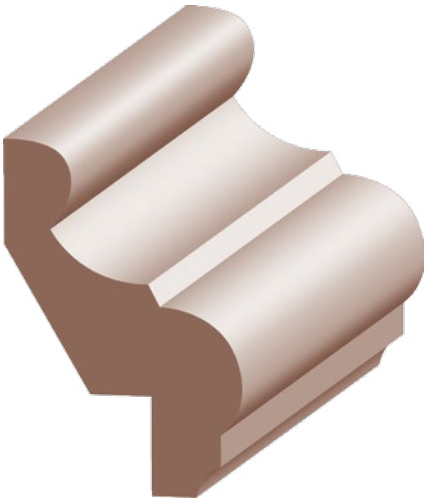

Panel Mold 3/4 x 2
(w/3/4" Rab't)
PR621A Primed

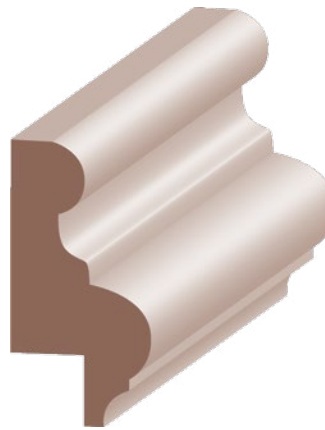

Panel Cap 3/4 x 1-1/2
(w/3/8" Rab't)
620A

ASTRAGAL

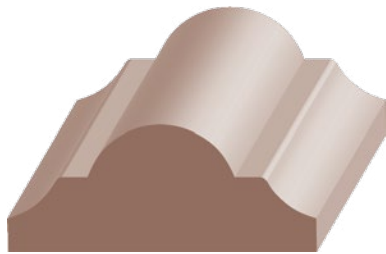

Flat Astragal 11/16 x 1-5/8
PR660A Primed
660A

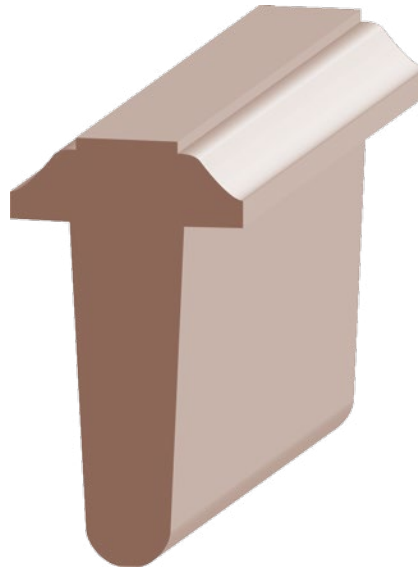

T-Astragal for 1-3/4\" Doors 1-1/4 x 2-1/4
661A

*Trimbacks are lengths other than standard. When a defect occurs during milling, the defect is removed leaving a length other than ordered. Trimbacks are considered any length 6' thru 15' and may represent up to 15% of a tally with 85% in the stocked length requested.



CLEAT & HOOK

Lengths Available: 16' with Trimbacks



**1 Eased Edge
Unprimed Cleat** 11/16 x 1-1/2
10FJ



1 Eased Edge Milled Hook 9/16 x 3-1/4
15FJ

STOOL

Lengths Available: 7' thru 17' with Trimbacks



Flat Stool 11/16 x 4-3/4
980A



Flat Stool 11/16 x 5-1/2
979A



Flat Stool 11/16 x 7-1/4
985A

*Trimbacks are lengths other than standard. When a defect occurs during milling, the defect is removed leaving a length other than ordered. Trimbacks are considered any length 6' thru 15' and may represent up to 15% of a tally with 85% in the stocked length requested.

(items are approximate scale only)

EXTERIOR MOLDS

Lengths Available: 7' & 17' with Trimbacks

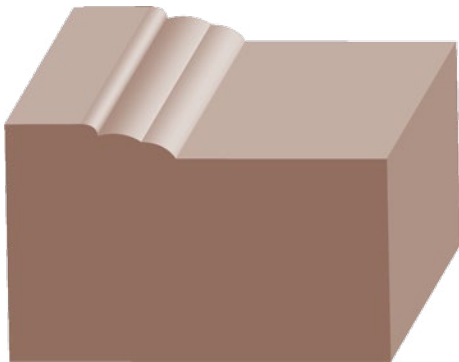

**180 Eastern
Brick Mold** 1-1/4 x 2
PR612A Primed
612A

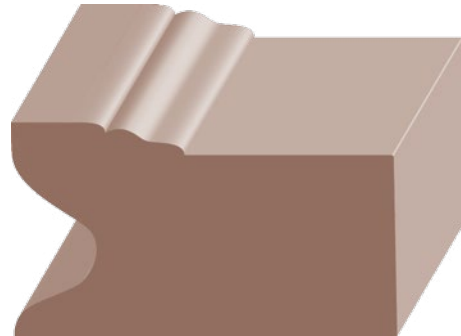

**180 Eastern Brick
Mold w/ Stucco Key** 1-1/4 x 2
PR612B Primed
612B

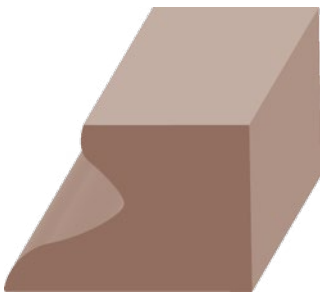

Flat Stucco Mold 7/8 x 1-3/16
953B

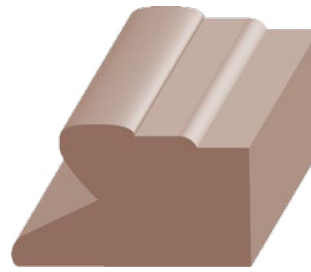

Stucco Mold 3/4 x 1-1/4
PR953A Primed
953A

APRON

Lengths Available: 16' with Trimbacks



Apron 3/8 x 1-1/2
902A

*Trimbacks are lengths other than standard. When a defect occurs during milling, the defect is removed leaving a length other than ordered. Trimbacks are considered any length 6' thru 15' and may represent up to 15% of a tally with 85% in the stocked length requested.



S1S & S4S

Lengths Available: 16' with Trimbacks



Non-Protected S1S2E Trimboards

Primed FJ Pine

ITEM	SIZE
PR760A	3/4x1-1/2
PR761A	3/4x2-1/2
PR762A	3/4x3-1/2
PR763A	3/4x5-1/2
PR764A	3/4x7-1/4
PR765A	3/4x9-1/4
PR766A	3/4x11-1/4
PR767A	1-1/16x3-1/2
PR768A	1-1/16x5-1/2
PR769A	1-1/16x7-1/4
PR770A	1-7/16x1-1/2
PR771A	1-7/16x3-1/2
PR772A	1-7/16x5-1/2
PR773A	1-7/16x7-1/4
PR774A	1-7/16x9-1/4
PR775A	1-7/16x11-1/4

Non-Protected S4SSE Trimboards

Primed FJ Pine

ITEM	SIZE
1X2S4S	3/4x1-1/2
1X3S4S	3/4x2-1/2
1X4S4S	3/4x3-1/2
1X5S4S	3/4x4-1/2
1X6S4S	3/4x5-1/2
1X8S4S	3/4x7-1/4
1X10S4S	3/4x9-1/4
1X12S4S	3/4x11-1/4



Interior S4S Boards

Primed FJ Pine

PR713A
PR715A
PR750A
PR751A
PR753A

FJ Pine

715A	11/16x3-1/2
750A	11/16x5-1/2
751A	11/16x7-1/4
753A	11/16x11-1/4

*Trimbacks are lengths other than standard. When a defect occurs during milling, the defect is removed leaving a length other than ordered. Trimbacks are considered any length 6' thru 15' and may represent up to 15% of a tally with 85% in the stocked length requested.

DOOR JAMBS & FRAMES

Lengths Available: 7' thru 17' with Trimbacks

Interior Door Jamb

Kerfing for bullnose is available on all jamb sizes and species. Custom size odd wall widths available upon request.



Specifications:

11/16" Thick
6/8 = 81" Below Dado
8/0 = 97" Below Dado

- Lineal = 17'
- Dado depth = 3/8"
- Heads cut 3/4 over opening
- 5 pair per bundle

SIZE	SPECIES	6/8	8/0	17' LINEAL
3-9/16	FJ Pine	391616	391618	3916IL
4-9/16	FJ Pine (Primed)	PR491616-81BD	PR491618-97BD	-
	FJ Pine	491616	491618	4916IL
4-3/4	FJ Pine (Primed)	PR43416-81BD	PR43418-97BD	-
	FJ Pine	43416	43418	4341IL
4-7/8	FJ Pine	47816	47818	4781IL
5-1/4	FJ Pine (Primed)	PR51416-81BD	PR51418-97BD	-
	FJ Pine	51416	51418	5141IL
5-1/2	FJ Pine	51216	51218	-
7-1/4	FJ Pine (Primed)	PR71416-81BD	PR71418-97BD	-
	FJ Pine	71416	71418	7141IL
7-1/2	FJ Pine	71216	71218	-
11-1/4	FJ Pine	111416	111418	1114IL

DOOR JAMBS & FRAMES



SIZE	SPECIES	6/8	17' LINEAL
4-1/8	FJ Pine	418SD6	418SDL
4-1/2	FJ Pine	412SD6	412SDL
4-3/4	FJ Pine	434SD6	434SDL
5-1/4	FJ Pine	514SD6	514SDL
6-1/8	FJ Pine	618SD6	618SDL
7-1/8	FJ Pine	714SD6	714SDL

**San Diego Exterior Door Jamb
1-1/4" Thick**

Kerfing for bullnose is available on all jamb sizes and species. Custom size odd wall widths available upon request.

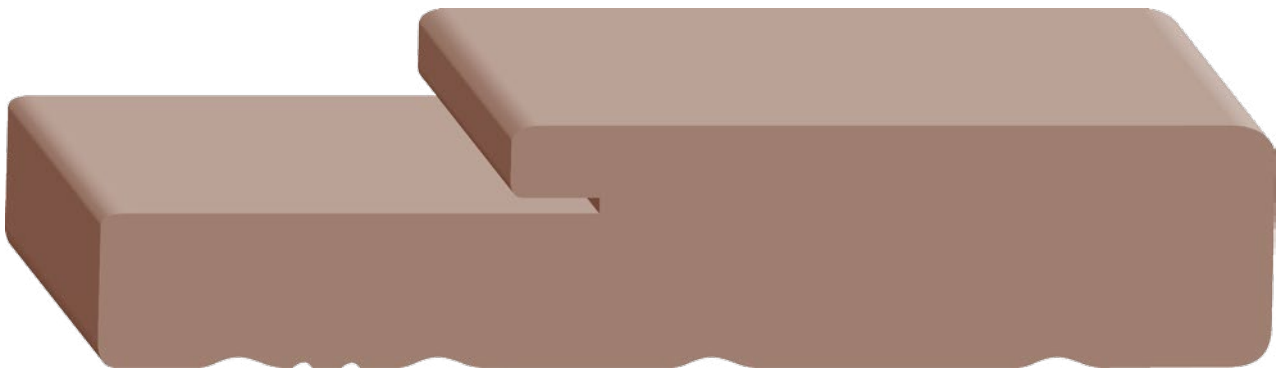

SIZE	SPECIES	6/8	8/0
4-1/8	FJ Pine (Primed)	PR418WSFR	PR418WS8FR
	FJ Pine	418WSFR	418WS8FR
4-3/4	FJ Pine (Primed)	PR434WSFR	PR434WS8FR
4-5/8	FJ Pine (Primed)	PR458WSFR	-
	FJ Pine	458WSFR	-
5-1/2	FJ Pine	PR514WSFR	PR514WS8FR
7-1/4	FJ Pine (Primed)	-	PR714WS8FR
	FJ Pine	PR714WSFR	714WS8FR

**20 Minute Fire-Rated Door Jamb
2-1/4" Thick**

Kerfed for Weatherstrip – w/ 2-1/8" Door Rab't

Kerfing for bullnose is available on all jamb sizes and species. Custom size odd wall widths available upon request.

** 20 Minute Fire-Rated Exterior Frames:
Sold in 3/0 sets only. Inquire for primed material in unprimed sizes.*



DOOR JAMBS & FRAMES

Lengths Available: 7' thru 17' with Trimbacks

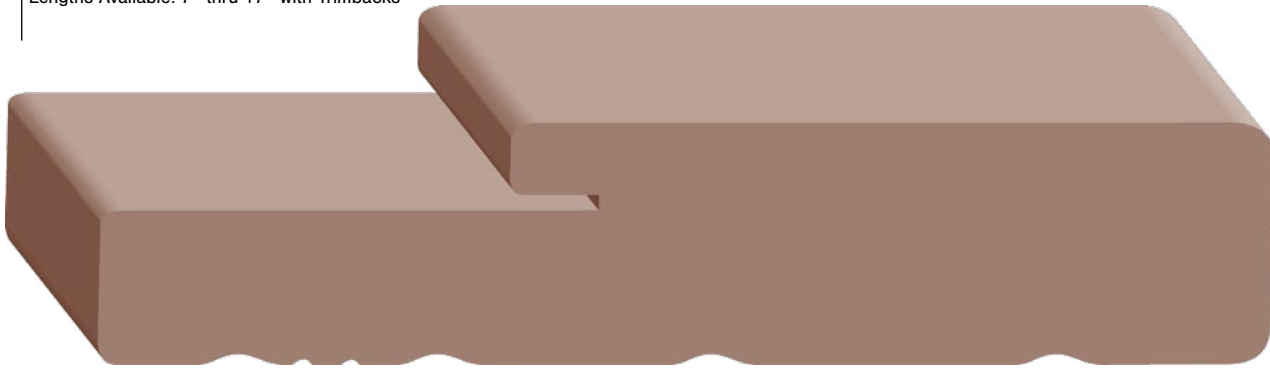

FJ Exterior Composite Door Jamb

Kerfed for Weatherstrip w/ 2-1/8" Door Rab't

SIZE	SPECIES	6/8	8/0	LINEAL
4-9/16	Primed Composite	PCF4916W6	PCF4916W8	-
	Primed FJ Frame Saver	FS4916W6	FS4916W8	-
5-1/4	Primed Composite	PCF514W6	PCF514W8	-
	Primed FJ Frame Saver	FS514W6	FS514W8	-
6-9/16	Primed Composite	PCF6916W6	PCF6916W8	-
	Primed FJ Frame Saver	FS6916W6	FS6916W8	-
	Primed FJ Frame Saver Dbl. Rab't	FS6916DR6	-	-
7-1/4	Primed Composite	PCF714W6	PCF714W8	PCF714W12 (12')
	Primed FJ Frame Saver	FS714W6	FS714W8	-
	Primed FJ Frame Saver Dbl. Rab't	FS714DR6	-	-

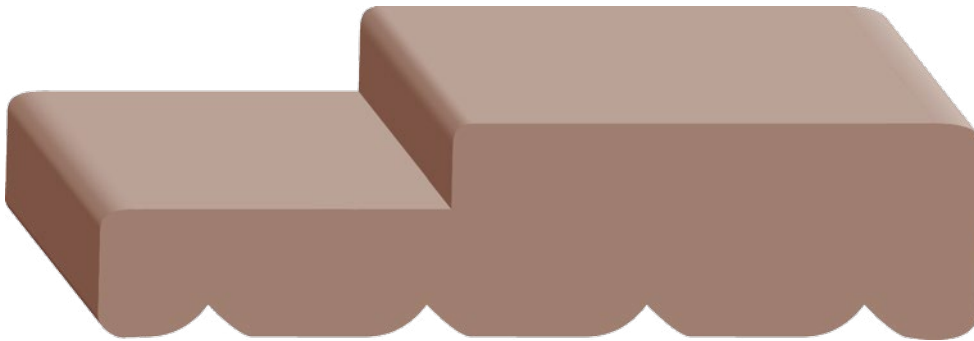

Standard Exterior Door Frame for 1-3/4" Doors

No kerf | With 1/2" x 1-3/8" Door Rab't

Specifications:

- 1-3/8" doors only
- 6/8 = 82-1/2" Below Dado
- 8/0 = 98-1/2" Below Dado

- No screen rab't
- Single end dado (except on lineal)
- 3 pairs per bundle
- Kerfing for Bullnose is available
- Custom widths available

SIZE	SPECIES	6/8	8/0	LINEAL
4-1/8	FJ Pine (Primed)	PR4186	PR4188	PR418L
	FJ Pine	4186	4188	418L
4-1/2	FJ Pine (Primed)	PR4126	PR4128	PR412L
	FJ Pine	4126	4128	412L
4-5/8	FJ Pine	4586	4588	458L
4-3/4	FJ Pine (Primed)	PR434E6	PR434E8	PR434EL
	FJ Pine	434E6	434E8	434EL
5-1/4	FJ Pine (Primed)	PR514E6	PR514E8	PR514EL
	FJ Pine	514E6	514E8	514EL
6-1/8	FJ Pine (Primed)	PR6186	PR6188	PR618L
	FJ Pine	6186	6188	618L
6-5/8	FJ Pine	6586	6588	658L
7-1/4	FJ Pine (Primed)	PR714E6	PR714E8	PR714EL
	FJ Pine	714E6	714E8	714EL

DOOR JAMBS & FRAMES

Lengths Available: 7' thru 17' with Trimbacks

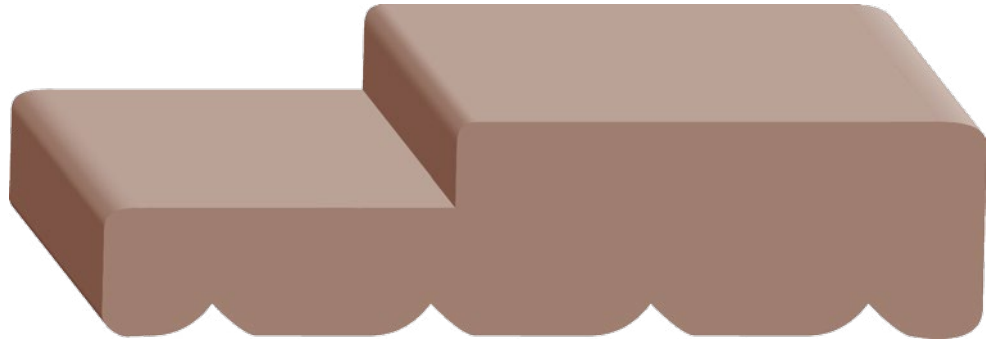

SIZE	SPECIES	6/8
4-1/8	FJ Pine (Primed)	418638
4-1/2	FJ Pine	PR412638-SR
4-3/4	FJ Pine (Primed)	434638
5-1/4	FJ Pine (Primed)	514638

Standard Exterior Door Frame for 1-3/4" Doors

No kerf | With 1/2" x 1-13/16" Door Rab't

Specifications:

1-3/8" doors only
 6/8 = 82-1/2" Below Dado
 8/0 = 98-1/2" Below Dado

- No screen rab't
- Single end dado (except on lineal)
- 3 pairs per bundle
- Kerfing for Bullnose is available
- Custom widths available



SIZE	SPECIES	6/8	8/0	17' LINEAL
4-1/8	FJ Pine (Primed)	PR418W6	PR418W8	PR418WL
	FJ Pine	418W6	418W8	418WL
4-1/2	FJ Pine	412W6	412W8	412WL
	FJ Pine (Primed)	PR458W6	PR458W8	PR458WL
4-5/8	FJ Pine (Primed)	PR458W6	PR458W8	PR458WL
	FJ Pine	458W6	458W8	458WL
4-3/4	FJ Pine (Primed)	PR434W6	PR434W8	PR434WL
	FJ Pine	434W6	434W8	434WL
5-1/4	FJ Pine (Primed)	PR514W6	PR514W8	PR514WL
	FJ Pine	514W6	514W8	514WL
5-1/2	FJ Pine	512W6	512W8	-
6-1/8	FJ Pine (Primed)	PR618W6	PR618W8	PR618WL
	FJ Pine	618W6	618W8	618WL
6-5/8	FJ Pine (Primed)	PR658W6	PR658W8	PR658WL
	FJ Pine	658W6	658W8	658WL
7-1/4	FJ Pine (Primed)	PR714W6	PR714W8	PR714WL
	FJ Pine	714W6	714W8	714WL
7-1/2	FJ Pine	712W6	712W8	-

Kerfed Exterior Door Frame for 1-3/4" Doors

for 1/2" x 2-1/8" Door Rab't

Specifications:

1-3/4" doors only
 6/8 = 82-1/2" Below Dado
 8/0 = 98-1/2" Below Dado

- No screen rab't
- Single end dado (except on lineal)
- 3 pairs per bundle
- Kerfing for Bullnose is available
- Custom widths available

Hardwoods

THE ENVIRONMENTALLY FRIENDLY CHOICE TO ADD BEAUTY AND VALUE



Inside

Astragal.....	109
Base, Base Cap, Base Shoe.....	72-80
Casing.....	63-70
Chair Rail.....	98-99
Crown & Cornice.....	81-96
Door Stop.....	51
Door Header & Top Cap.....	71
Door Jambs & Frames.....	115-116
Dental Moulding.....	97
Exterior Mold.....	112
Handrails.....	100-102
Interior Door Jamb.....	115
Nose & Cove.....	110
Outside Corner Guard.....	111
Panel Cap.....	104-106
Panel Mold.....	102-103
Quarter, Half & Full Round.....	108
Rope.....	106
S4S.....	113
Screen Mold.....	108
Sill.....	113
Stool & Lintel.....	111
T&G Wainscot & Base.....	107
Threshold.....	114
T-Mold & Reducer.....	112



Hardwoods

THE ENVIRONMENTALLY FRIENDLY CHOICE TO ADD BEAUTY AND VALUE



Hardwood mouldings add tremendous value to any residential or commercial project. In-stock and available for immediate delivery, you can choose from oak, maple, cherry, mahogany, alder and poplar.

All hardwoods, with the exception of poplar, are stain grade and come in 6' – 16' lengths – predominantly in 6' – 12' lengths. Alder is available up to 10' lengths only.

Green Choices

American hardwoods are the environmentally friendly choice whether your style is architecturally modern or traditional. Our temperate U.S. forests grow nearly twice as much hardwood as we harvest each year. This kind of sustainability is meeting today's needs, without compromising the ability to meet future generations' needs. With far more hardwood growth than there is harvesting, American hardwoods for moulding and millwork are the definition of environmentally friendly, green and sustainable, now and for future generations.

Hardwood Characteristics

Oak: Southern Oak is strong and durable with a beautiful grain that is easy to stain. Generally available in 6' - 12' lengths. Long lengths are rare.

Poplar: Little to no grain with light and dark color fluctuations. A green hue is also common. High-end paintgrade product. Can be professionally stained.

Alder: Stylish and rustic. Most profiles are Superior Alder grade. Knotty Alder is considered premium. Longest length available is 10' frame-grade.

Cherry: Spectacular in both color and grain. The sapwood in American Cherry adds a white variation to its pure red coloring. Cherry that's completely red is considered premium and is not typical of standard stock – it must be specially quoted when "all red" is required.

Mahogany: Deep rich coloration from pale reddish to dark brown. Flecking is typical.

Maple: Light in color. May be stained or clear coated. Available in hard or soft Maple. Check stock for availability when one or the other is specifically required.

LARGE PATTERN SELECTION

6' AND LONGER

STRONG AND DURABLE

(items are approximate scale only)

1-9/16" to 2-1/2" CASING

Lengths Available: 6' thru 16'

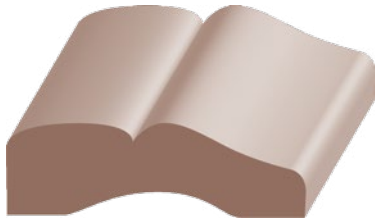

#711 Casing 1/2 x 1-9/16
107-O Oak



Flat Streamline Casing 5/8 x 1-5/8
102-O Oak

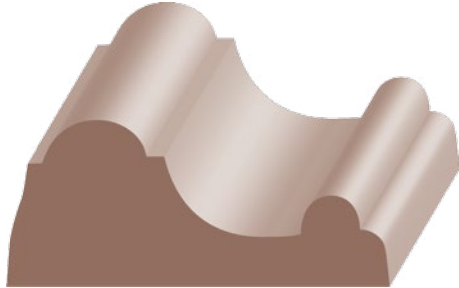

Malibu Casing 7/8 x 2
179-O Oak
179P Poplar
179ALD Alder
179C Cherry
179MH Mahogany
179MP Maple

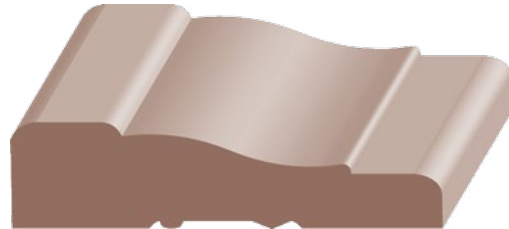

#356 Casing 5/8 x 1-5/8
152-O Oak

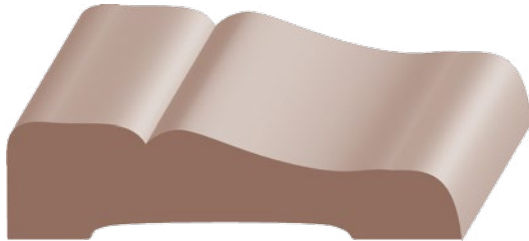

#711 Casing 5/8 x 2-3/8
108-O Oak
108P Poplar
108ALD Alder
108MH Mahogany

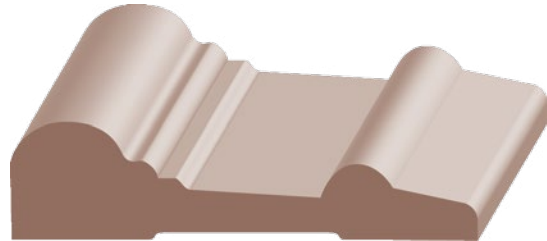

Universal Casing 5/8 x 2-7/16
115-O Oak

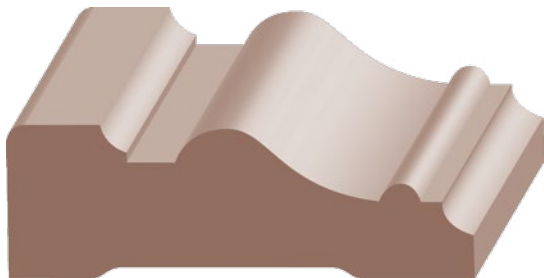

#275 Casing 13/16 x 2-7/16
183P Poplar
183C Cherry
183MH Mahogany
183MP Maple



2 Round Edge Casing 5/8 x 2-1/2
120-O Oak
120P Poplar
120ALD Alder
120C Cherry
120MH Mahogany
120MP Maple

*Hardwood mouldings generally are available in 12' and under. For lengths over 12', please check for availability.



2-1/2" to 2-7/8" CASING

Lengths Available: 6' thru 16'

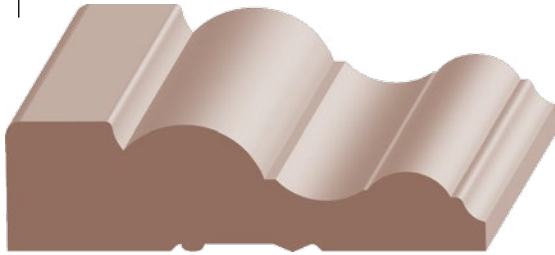

Bel-Air Casing 11/16 x 2-1/2

128-O	Oak
128P	Poplar
128ALD	Alder
128C	Cherry
128MH	Mahogany
128MP	Maple

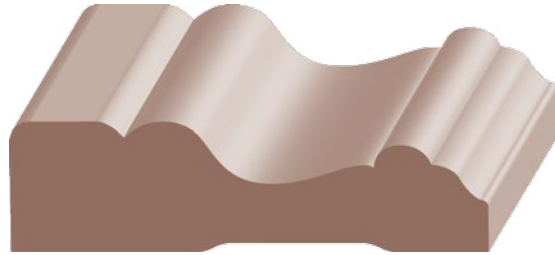

Cape Cod Casing 11/16 x 2-1/2

150-O	Oak
150P	Poplar
150ALD	Alder
150C	Cherry
150MH	Mahogany
150MP	Maple

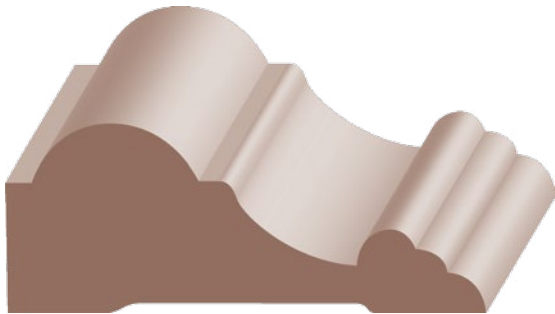

Hermosa Casing 1 x 2-1/2

159P	Poplar
-------------	--------

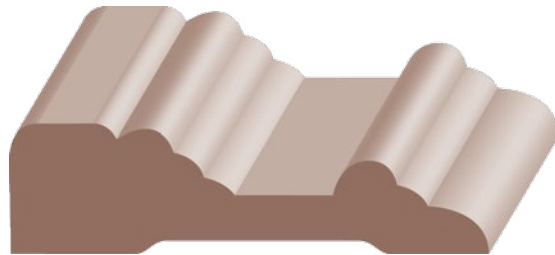

Crescent Casing 11/16 x 2-1/2

168-O	Oak
168P	Poplar

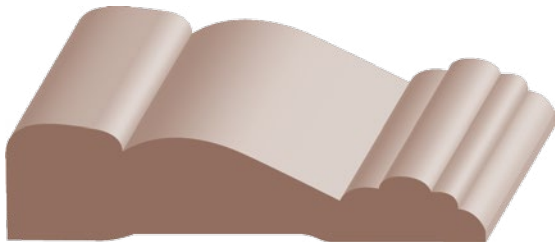

Tudor Casing 5/8 x 2-1/2

169-O	Oak
--------------	-----

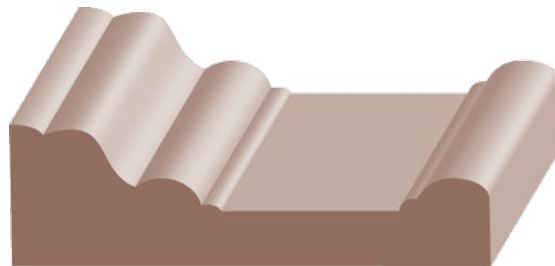

Howe Casing 3/4 x 2-1/2

176P	Poplar
-------------	--------

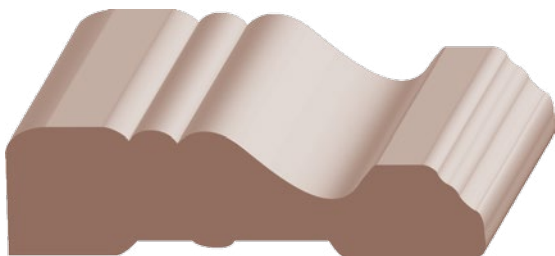

Palisade Casing 11/16 x 2-1/2

182ALD	Alder
---------------	-------

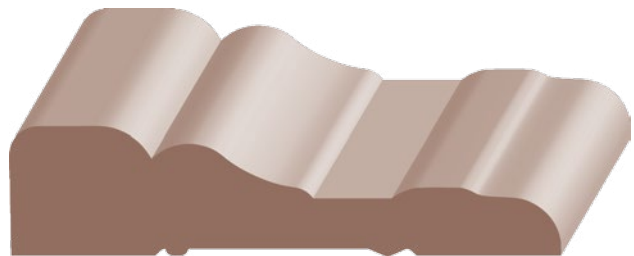

Colonial Casing 11/16 x 2-7/8

119-O	Oak
119P	Poplar

*Hardwood mouldings generally are available in 12' and under. For lengths over 12', please check for availability.

(items are approximate scale only)

2-7/8" to 3-1/4" CASING

Lengths Available: 6' thru 16'

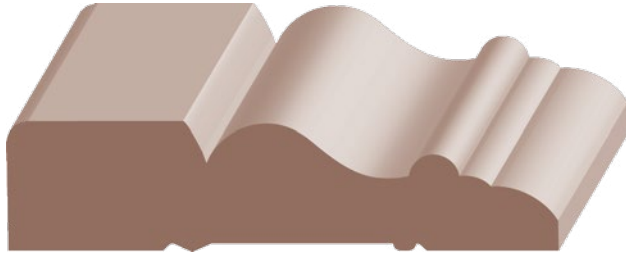

Newport Casing		11/16 x 2-7/8
125-O	Oak	
125P	Poplar	
125ALD	Alder	
125KA	Knotty Alder	
125C	Cherry	
125MH	Mahogany	
125MP	Maple	

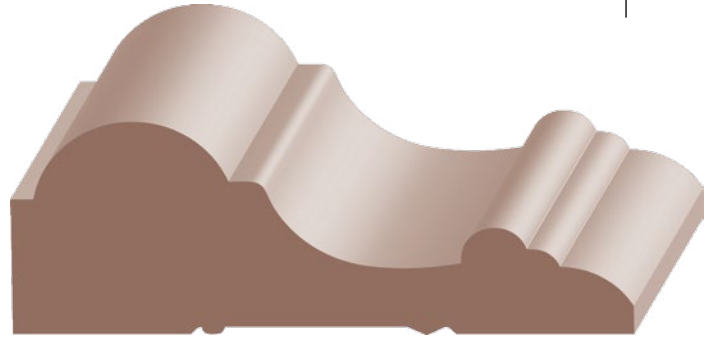

Hermosa Casing		1-1/8 x 3-1/4
160-O	Oak	
160P	Poplar	
160ALD	Alder	
160KA	Knotty Alder	
160C	Cherry	
160MH	Mahogany	
160MP	Maple	



Mullion Casing		5/16 x 3-1/4
114-O	Oak	

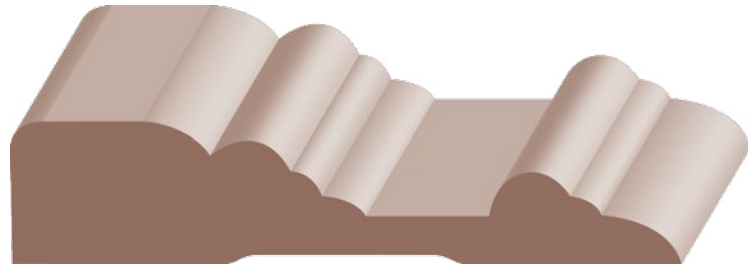

Crescent Casing		(3/4)" x 3-1/4
126-O	Oak	
126P	Poplar	

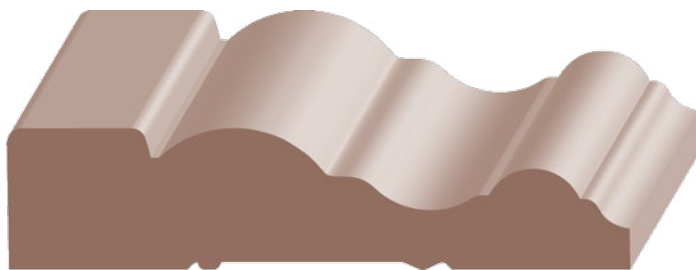

Bel-Air Casing		3/4 x 3-1/4
129-O	Oak	
129P	Poplar	
129ALD	Alder	
129KA	Knotty Alder	
129C	Cherry	
129MH	Mahogany	
129MP	Maple	



2 Round Edge Casing		13/16 x 3-1/4
139-O	Oak	
139P	Poplar	
139ALD	Alder	
139KA	Knotty Alder	
139C	Cherry	
139MH	Mahogany	
139MP	Maple	

*Hardwood mouldings generally are available in 12' and under. For lengths over 12', please check for availability.



3-1/4" to 3-3/8" CASING

Lengths Available: 6' thru 16'

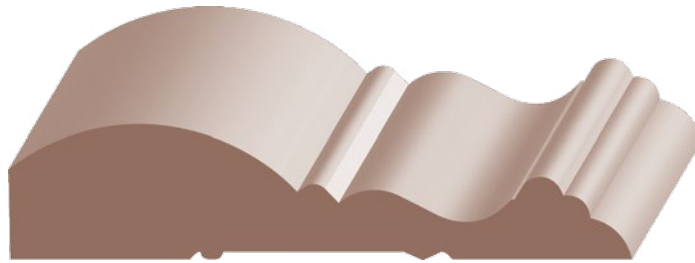

Cambridge Casing $1\frac{1}{16} \times 3\text{-}\frac{1}{4}$
161-O Oak

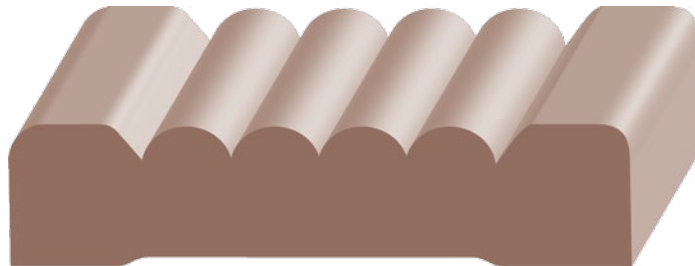

Reed Casing $\frac{3}{4} \times 3\text{-}\frac{1}{4}$
CA326-O Oak
CA326P Poplar

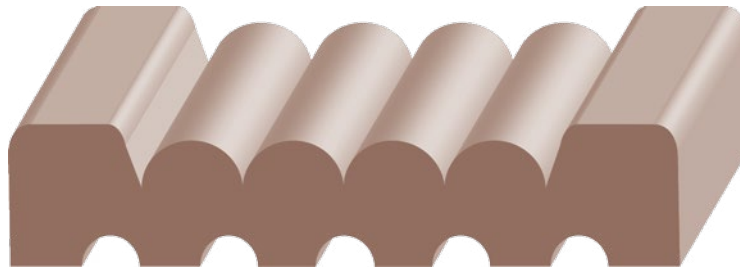

5-Flute & Reed Casing (Reversible) $\frac{3}{4} \times 3\text{-}\frac{1}{2}$
158-O Oak
158P Poplar
158ALD Alder
158C Cherry
158MH Mahogany
158MP Maple

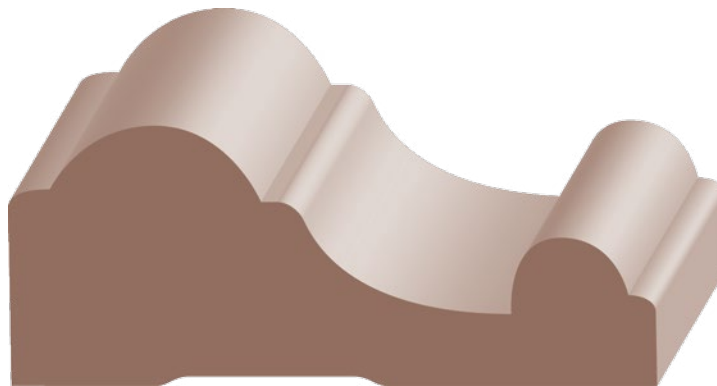

Malibu Casing $1\text{-}\frac{3}{8} \times 3\text{-}\frac{3}{8}$
180P Poplar

*Hardwood mouldings generally are available in 12' and under. For lengths over 12', please check for availability.

(items are approximate scale only)

3-1/2" CASING

Lengths Available: 6' thru 16'

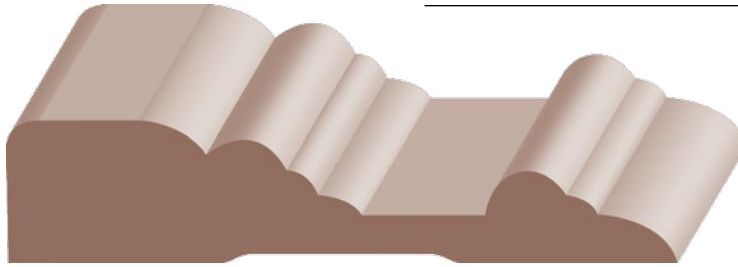

Crescent Casing $3/4 \times 3-1/2$
126-O Oak
126P Poplar

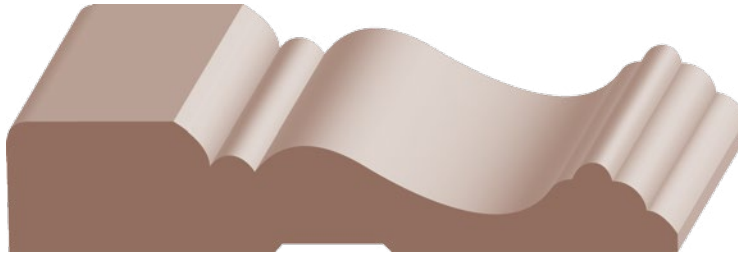

Cape Cod Casing $11/16 \times 3-1/2$
155-O Oak
155P Poplar
155ALD Alder

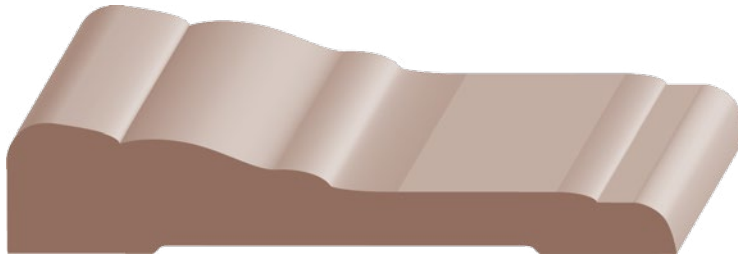

Colonial Casing $11/16 \times 3-1/2$
156-O Oak

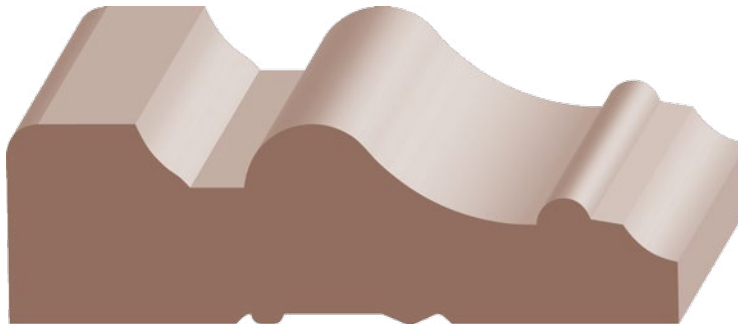

#275 Casing $1-1/16 \times 3-1/2$
165P Poplar
165ALD Alder
165KA Knotty Alder
165C Cherry
165MH Mahogany
165MP Maple

*Hardwood mouldings generally are available in 12' and under. For lengths over 12', please check for availability.



3-1/2" to 3-3/4" CASING

Lengths Available: 6' thru 16'

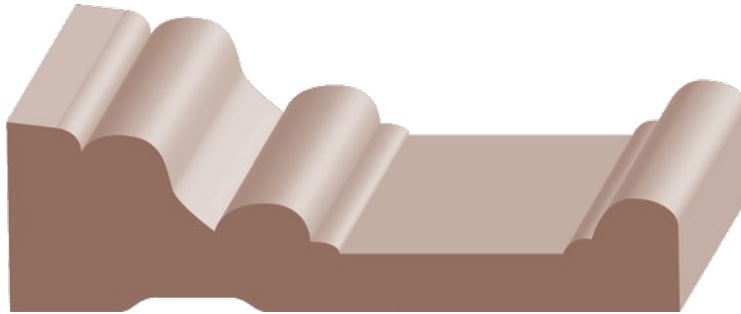

Howe Casing	1 x 3-1/2
177P	Poplar

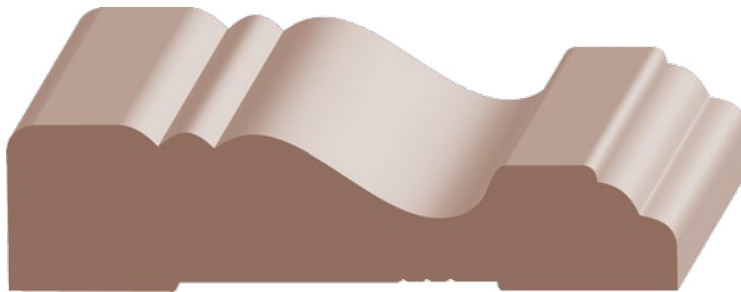

Palisade Casing	7/8 x 3-1/2
185ALD	Alder

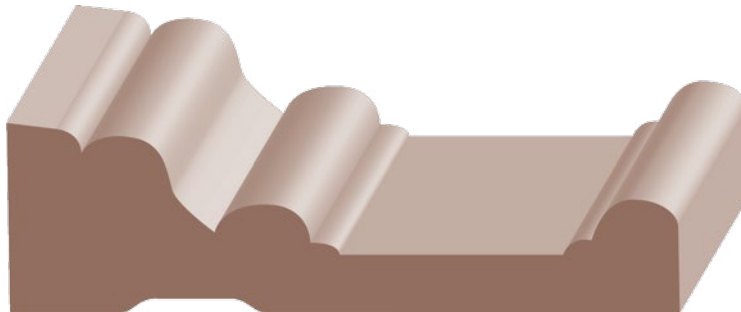

Tuscany Casing	13/16 x 3-1/2
CA364P	Poplar

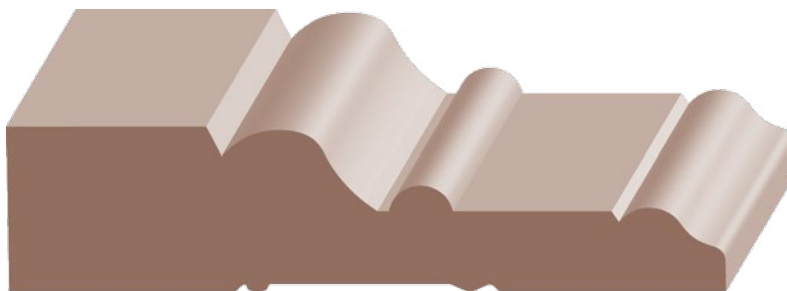

Tuscany Casing	7/8 x 3-3/4
175-O	Oak
175C	Cherry
175MH	Mahogany
175MP	Maple

*Hardwood mouldings generally are available in 12' and under. For lengths over 12', please check for availability.

(items are approximate scale only)

4" to 4-1/4" CASING

Lengths Available: 6' thru 16'



**2 Eased Edge
Craftsman Casing** $\frac{3}{4} \times 4$
186ALD Alder

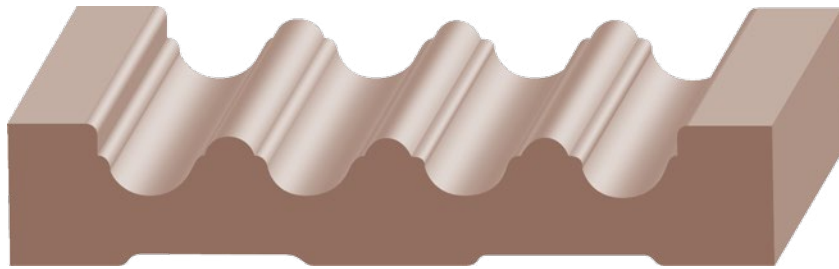

Fancy 4-Flute Casing $\frac{3}{4} \times 4$
CA327P Poplar

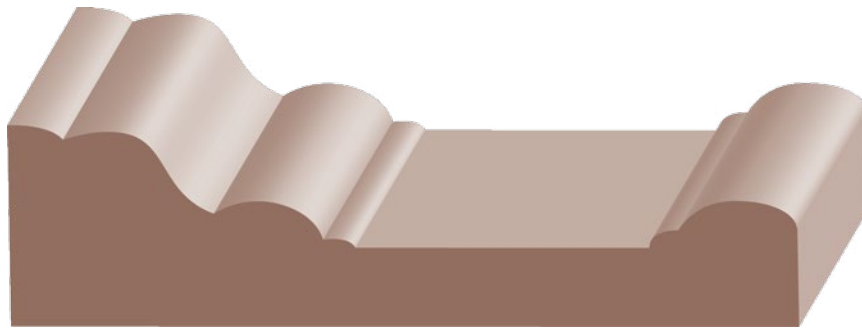

Howe Casing $1\text{-}\frac{1}{16} \times 4\text{-}\frac{1}{8}$
178P Poplar

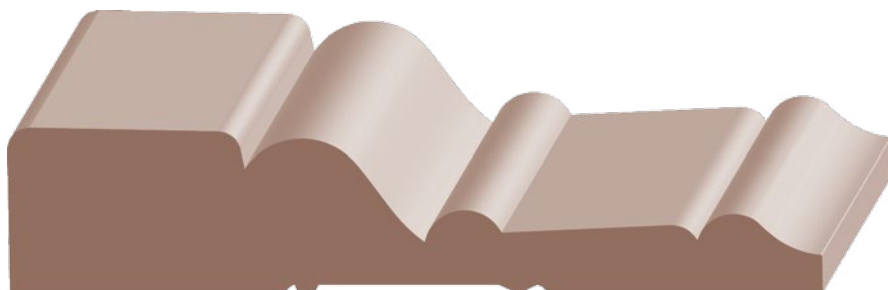

Tuscany Casing $\frac{7}{8} \times 4\text{-}\frac{1}{4}$
140P Poplar

*Hardwood mouldings generally are available in 12' and under. For lengths over 12', please check for availability.



4-1/4" to 5-1/2" CASING

Lengths Available: 6' thru 16'

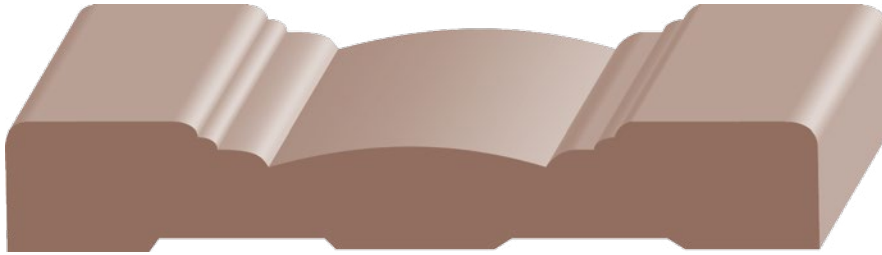

**Victorian Casing/
Chair Rail** 11/16 x 4-1/4
184-O Oak

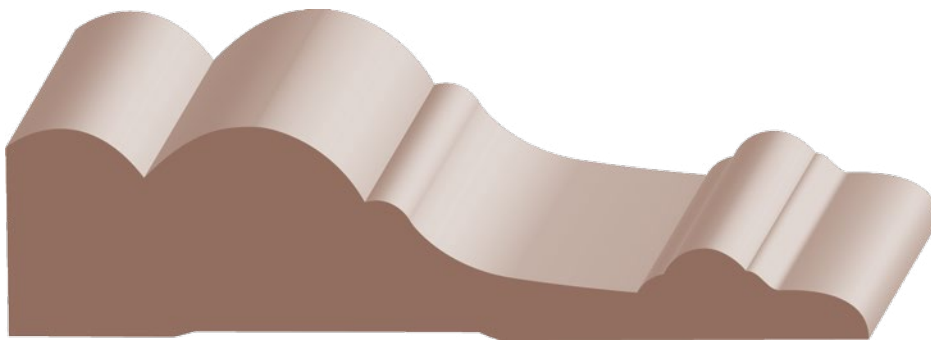

Sedona Casing 1-1/8 x 4-1/2
190P Poplar

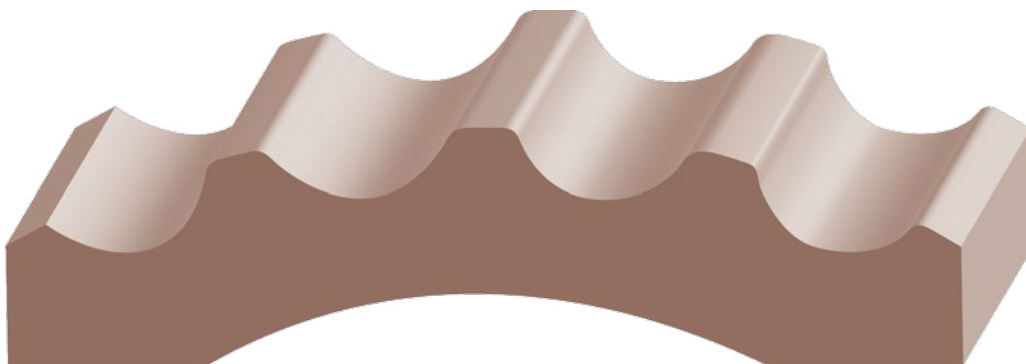

Fluted Radial Casing 1-1/4 x 5
191P Poplar

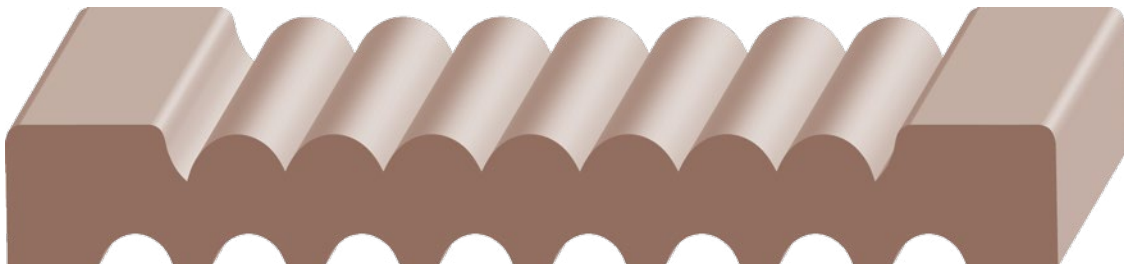

**8-Flute & Reed Cas-
ing (Reversible)** 3/4 x 5-1/2
171P Poplar

*Hardwood mouldings generally are available in 12' and under. For lengths over 12', please check for availability.

(items are approximate scale only)

DOOR HEADER & TOP CAP

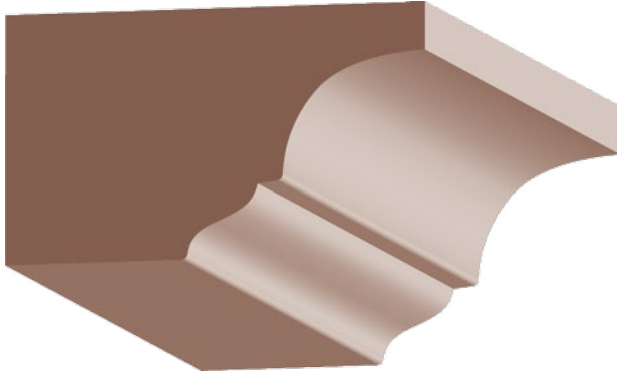

Craftsman Door Header
DH150ALD 1-3/4 x 2-1/4
Alder

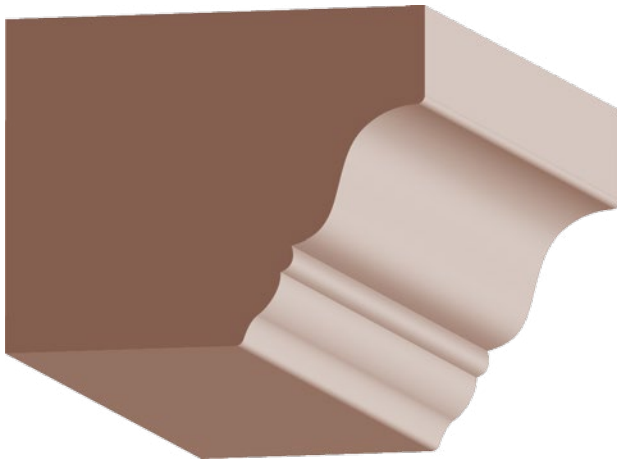

Top Cap
TC150-O
TC150P 1-3/4 x 2-1/4
Oak
Poplar

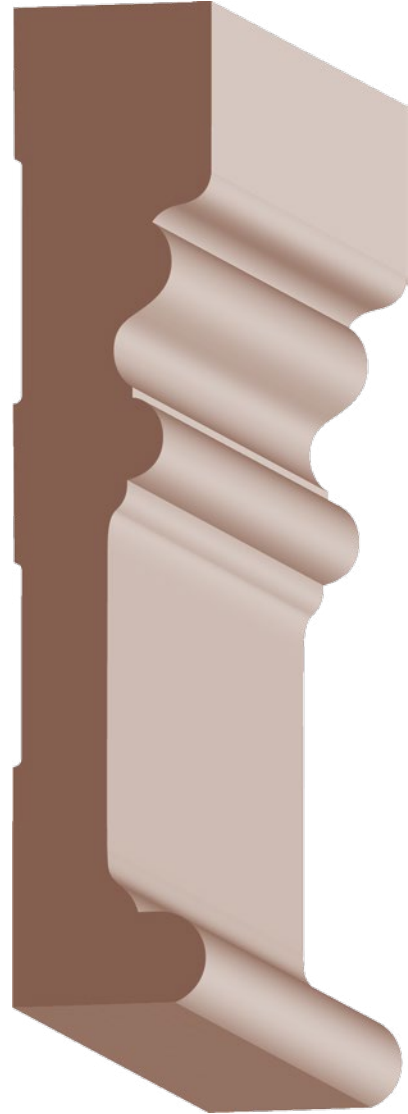

Door Header
DH190-O
DH190P 1-1/16 x 5-1/4
Oak
Poplar

*Hardwood mouldings generally are available in 12' and under. For lengths over 12', please check for availability.



3/4" to 3-1/2" BASE, BASE SHOE & BASE CAP

Lengths Available: 6' thru 16'

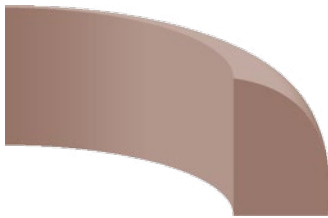

Base Shoe Corner

	3/8 x 3/4
300-OW	Oak
	1/2 x 3/4
300B-OW	Oak
300BPW	Poplar
300BALDW	Alder
300BCW	Cherry
300BMHW	Mahogany
300BMPW	Maple
	3/8 x 3/4 (goes over 3/8" or 7/16")
3001-OW	Oak
	3/8 x 3/4 (goes over 1/2" or 9/16")
3002-OW	Oak
	1/2 x 3/4 (goes over 3/8" or 7/16")
3001B-OW	Oak
3001BMPW	Maple
	1/2 x 3/4 (goes over 1/2" or 9/16")
3002B-OW	Oak
3002BPW	Poplar
3002BALDW	Alder
3002BMPW	Maple

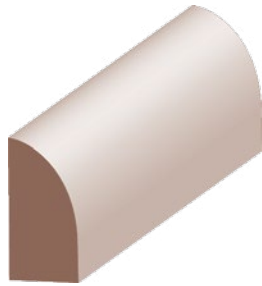

Base Shoe 3/8 x 3/4
300-O Oak

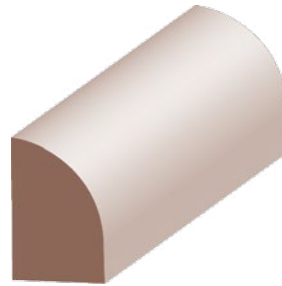

Base Shoe 1/2 x 3/4
300B-O Oak
300BP Poplar
300BALD Alder
300BC Cherry
300BMH Mahogany
300BMP Maple

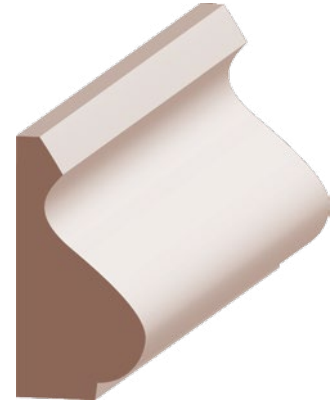

Base Cap 11/16 x 1-3/8
614-O Oak
614P Poplar
614C Cherry
614MH Mahogany
614MP Maple

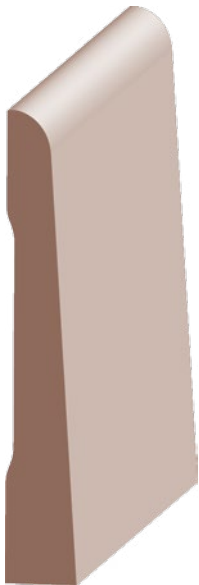

Streamline Base 3/8 x 2-1/2
306-O Oak



#711 Base 3/8 x 2-1/2
310-O Oak

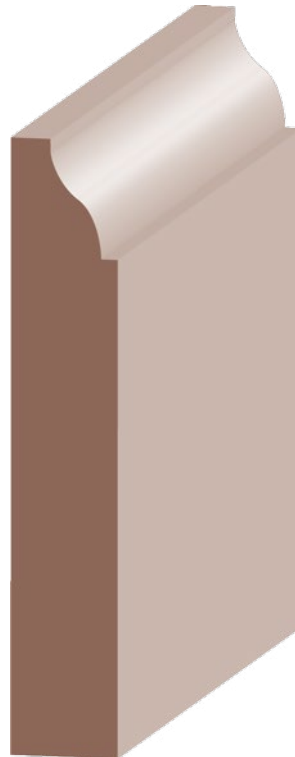

#623 Base 9/16 x 3-1/4
314ALD-3 Alder

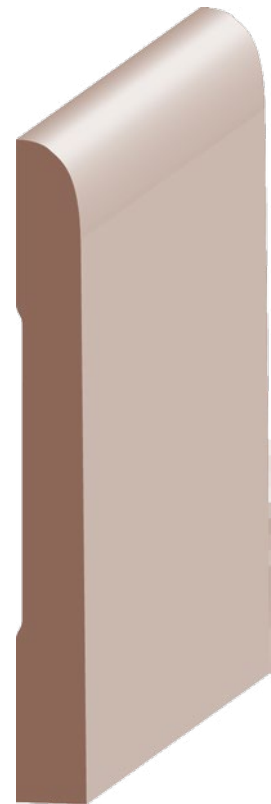

Streamline Base 3/8 x 3-1/2
307-O Oak

*Hardwood mouldings generally are available in 12' and under. For lengths over 12', please check for availability.

(items are approximate scale only)

3-1/2" to 3-7/8" BASE

Lengths Available: 6' thru 16'

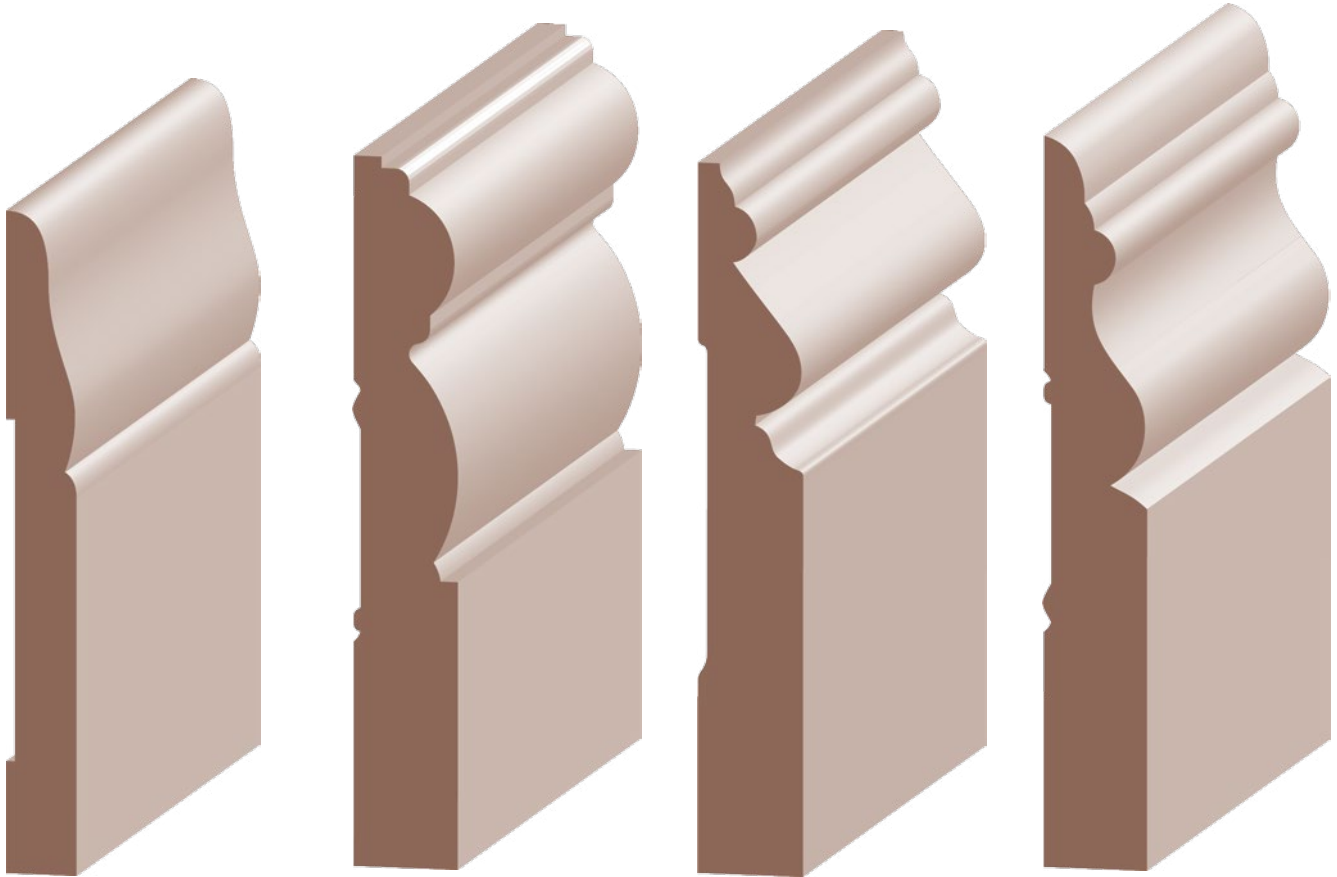

#711 Base 3/8 x 31/2
311-O Oak
311P Poplar
311ALD Alder
311MH Mahogany

Hermosa Base 9/16 x 3-3/4
324-O Oak
324P Poplar
324ALD Alder
324C Cherry
324MH Mahogany
324MP Maple

#175 Base 9/16 x 3-3/4
362P Poplar

Newport Base 9/16 x 3-7/8
329-O Oak
329P Poplar
329ALD Alder
329KA Knotty Alder
329C Cherry
329MH Mahogany
329MP Maple

*Hardwood mouldings generally are available in 12' and under. For lengths over 12', please check for availability.



4" to 4-1/4" BASE

Lengths Available: 6' thru 16'



Cape Cod Base

9/16 x 4

318-O	Oak
318P	Poplar
318ALD	Alder
318C	Cherry
318MH	Mahogany
318MP	Maple

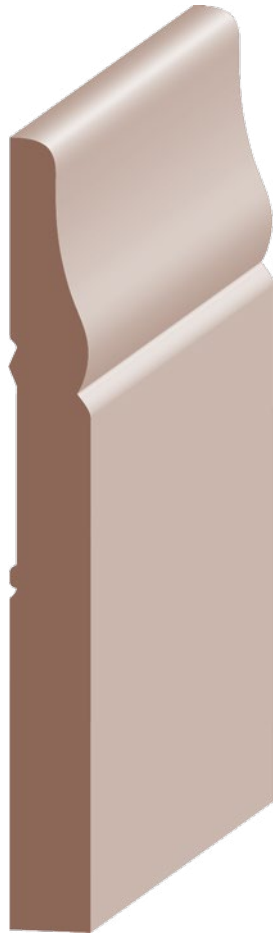

#711 Base

7/16 x 4-3/16

311P-4	Poplar
311ALD-4	Alder
311MH-4	Mahogany

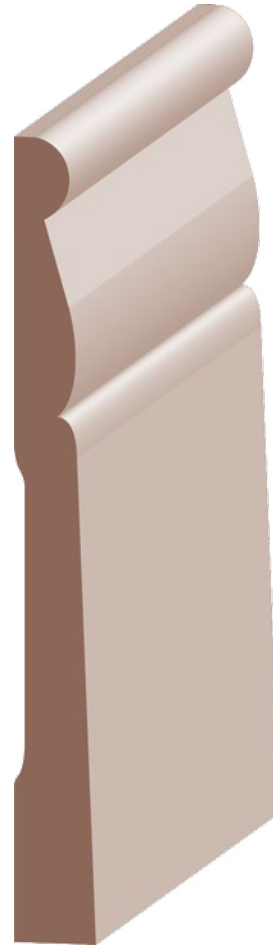

Monterey Base

7/16 x 4-1/4

316-O	Oak
--------------	-----

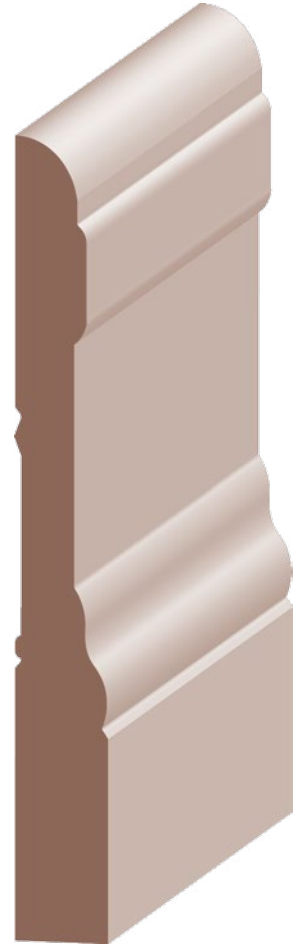

Colonial Base

1/2 x 4-1/4

118-O	Oak
118P	Poplar

*Hardwood mouldings generally are available in 12' and under. For lengths over 12', please check for availability.

(items are approximate scale only)

4-1/4" to 4-3/8" BASE

Lengths Available: 6' thru 16'

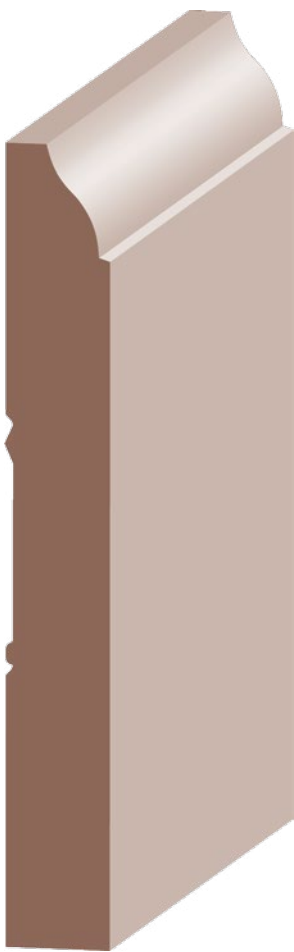

#620 Base 9/16 x 4-1/4
314ALD-4 Alder
314C-4 Cherry
314MH-4 Mahogany
314MP-4 Maple

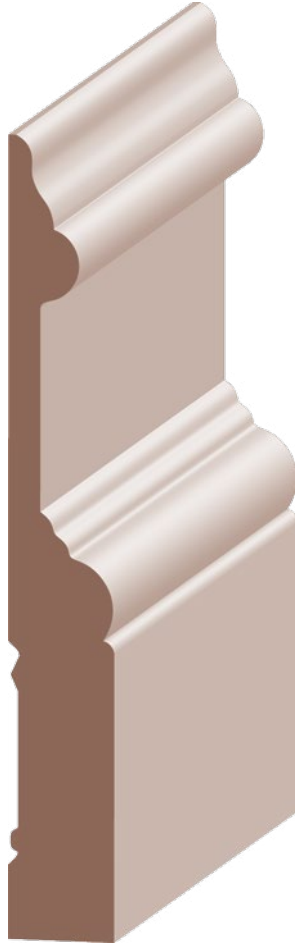

Crescent Base 9/16 x 4-1/4
326-O Oak
326P Poplar

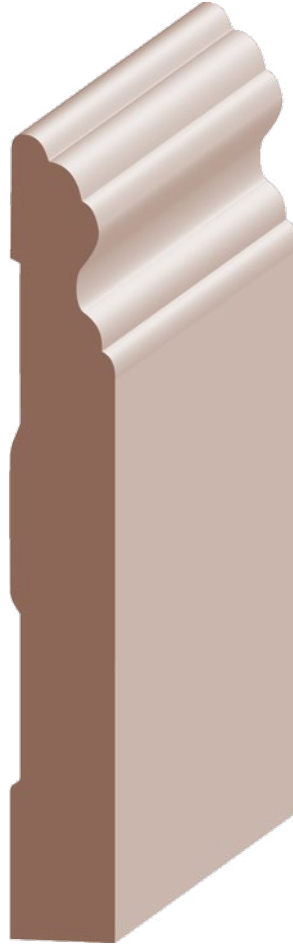

Mission Bay Base 9/16 x 4-1/4
361P Poplar

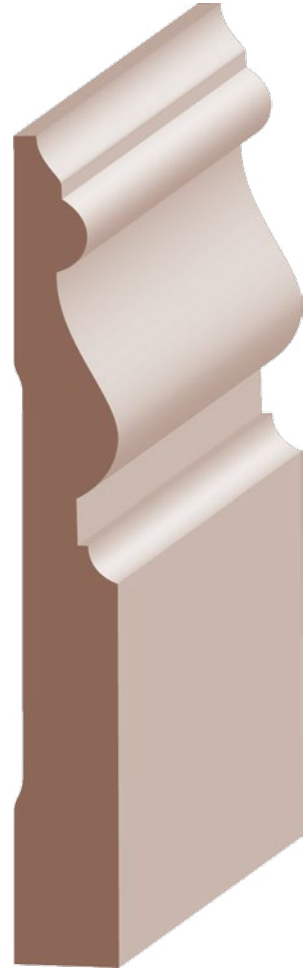

#175 Base 9/16 x 4-3/8
325P Poplar
325ALD Alder
325C Cherry
325MH Mahogany
325MP Maple

*Hardwood mouldings generally are available in 12' and under. For lengths over 12', please check for availability.



4-3/8" to 5-1/4" BASE

Lengths Available: 6' thru 16'

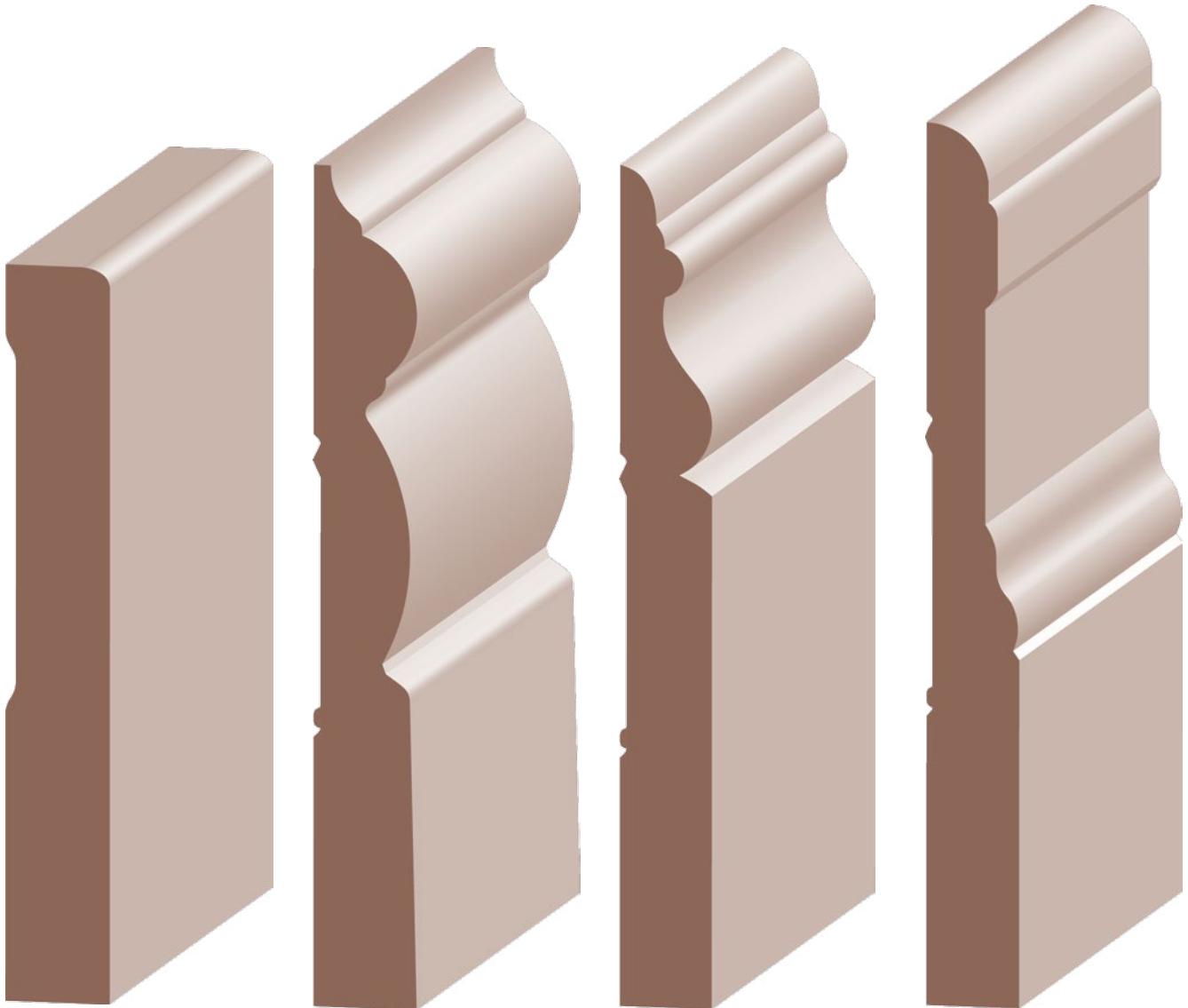

**1 Eased Edge
Craftsman
Base** 5/8 x 4-3/8

348-O	Oak
348P	Poplar
348ALD	Alder
348C	Cherry
348MH	Mahogany
348MP	Maple

**Hermosa
Base** 5/8 x 5

323-O	Oak
323P	Poplar
323C	Cherry
323MH	Mahogany
323MP	Maple

**Newport
Base** 9/16 x 5

330-O	Oak
330P	Poplar
330ALD	Alder
330KA	Knotty Alder
330C	Cherry
330MH	Mahogany
330MP	Maple

**Colonial
Base** 9/16 x 5-1/4

118P-5	Poplar
---------------	--------

*Hardwood mouldings generally are available in 12' and under. For lengths over 12', please check for availability.

(items are approximate scale only)

5-1/4" to 5-3/8" BASE

Lengths Available: 6' thru 16'

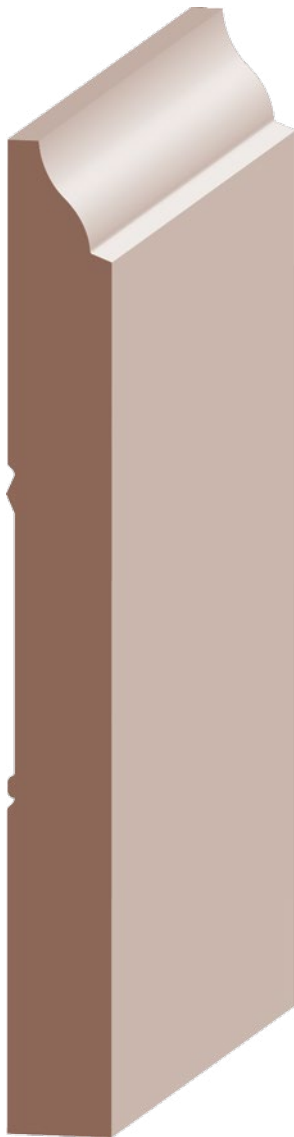

#618 Base 9/16 x 5-1/4
315P Poplar
315ALD Alder



"B" Cape Cod Base 9/16 x 5-1/4
318B-O Oak
318BP Poplar
318BALD Alder
318BC Cherry
318BMH Mahogany
318BMP Maple

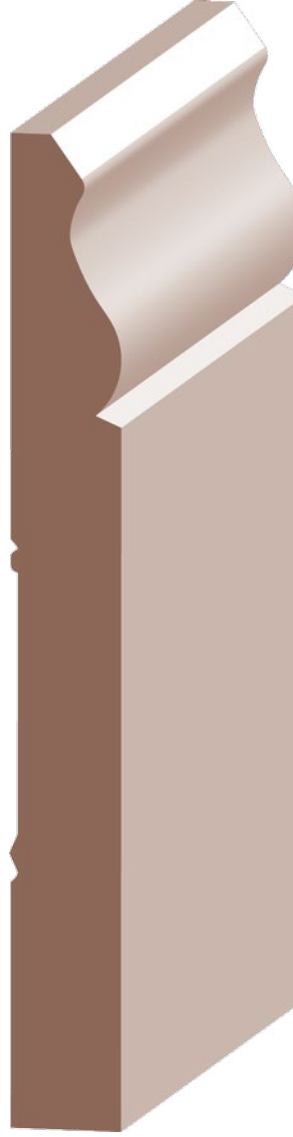

Colonial Base 9/16 x 5-1/4
328P Poplar
328ALD Alder

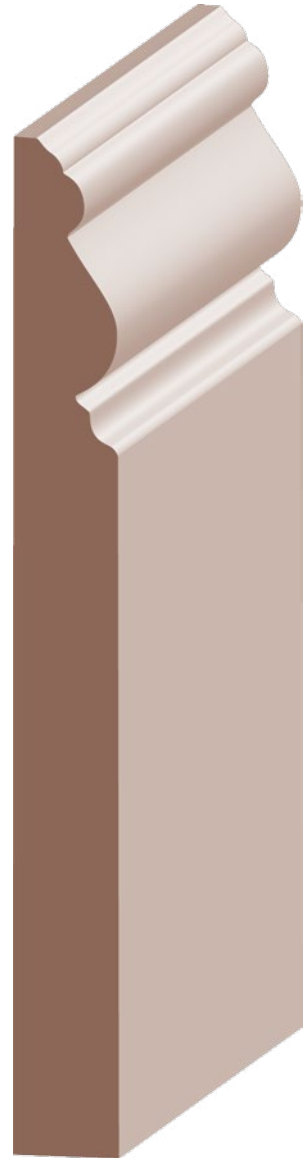

#175 Base 9/16 x 5-3/8
338P Poplar
338C Cherry
338MH Mahogany
338MP Maple

*Hardwood mouldings generally are available in 12' and under. For lengths over 12', please check for availability.



5-3/4" to 6" BASE

Lengths Available: 6' thru 16'

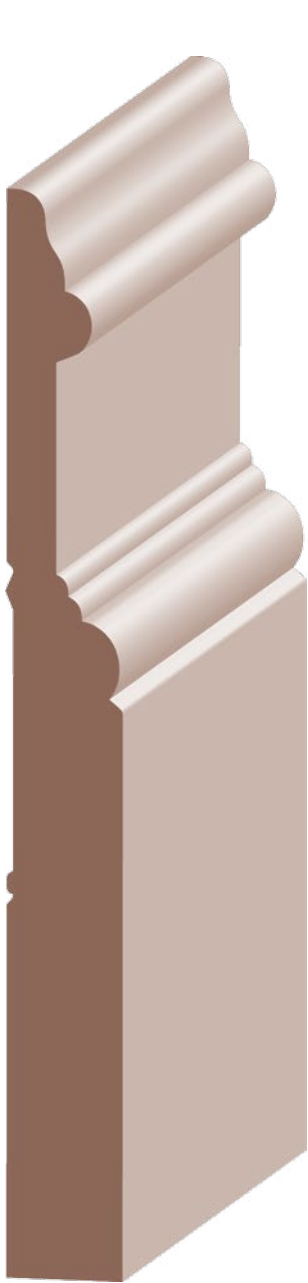

Crescent Base

5/8 x 5-3/4

332P

Poplar



#175 Base

5/8 x 6

342ALD
342KA

Alder
Knotty Alder

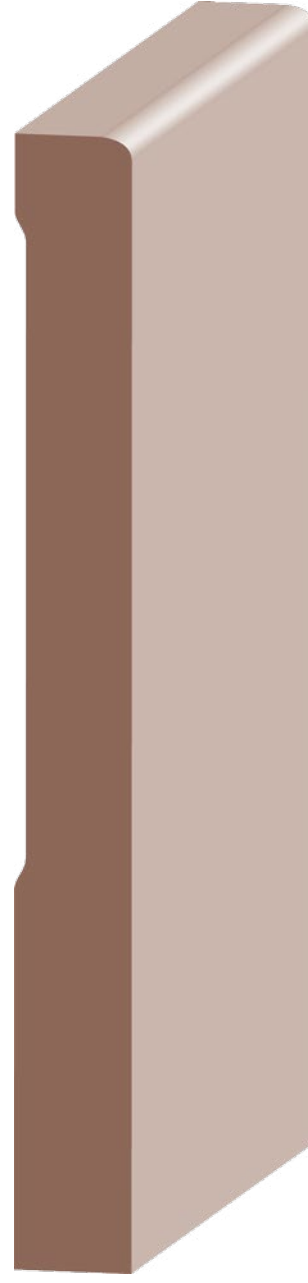

1 Eased Edge Craftsman Base

5/8 x 6

383-O
383P
383ALD
383KA
383C
383MH
383MP

Oak
Poplar
Alder
Knotty Alder
Cherry
Mahogany
Maple

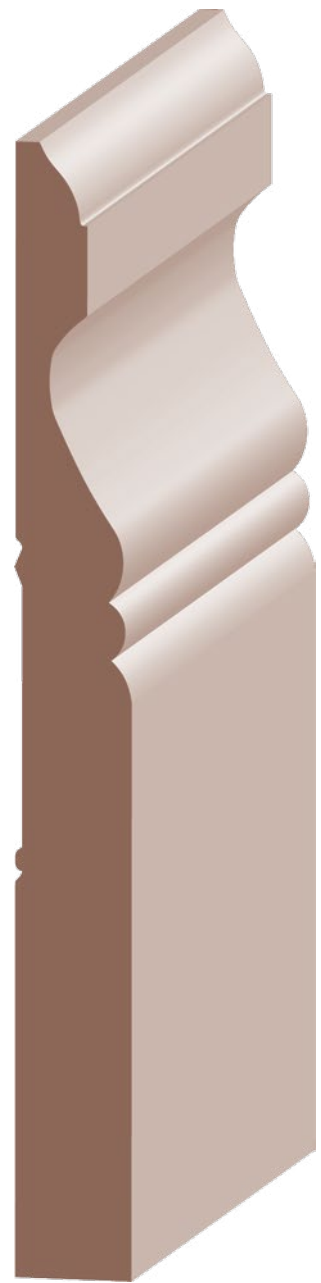

Palisade Base

5/8 x 6

385ALD

Alder

*Hardwood mouldings generally are available in 12' and under. For lengths over 12', please check for availability.

(items are approximate scale only)

6" to 6-1/4" BASE

Lengths Available: 6' thru 16'

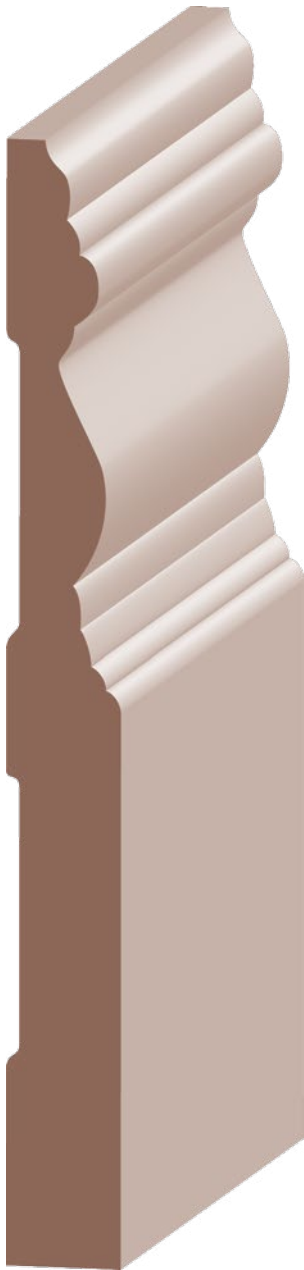

Cape Cod Base
360P 5/8 x 6
Poplar



Victorian Base
363P 1 1/16 x 6
Poplar



Tuscany Base
375-O 1 1/16 x 6 Oak
375C Cherry
375MH Mahogany
375MP Maple

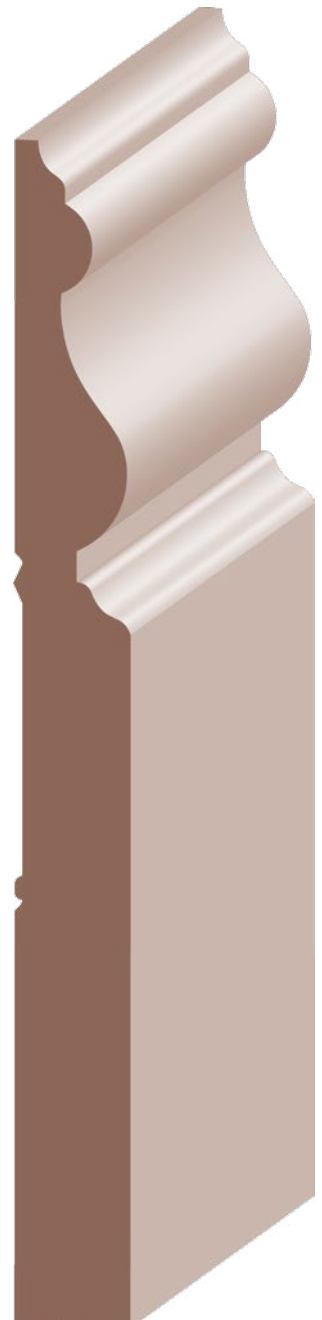

#175 Base 5/8 x 6-1/4
342P Poplar
342C Cherry
342MH Mahogany
342MP Maple

*Hardwood mouldings generally are available in 12' and under. For lengths over 12', please check for availability.



7-1/4" BASE

Lengths Available: 6' thru 16'

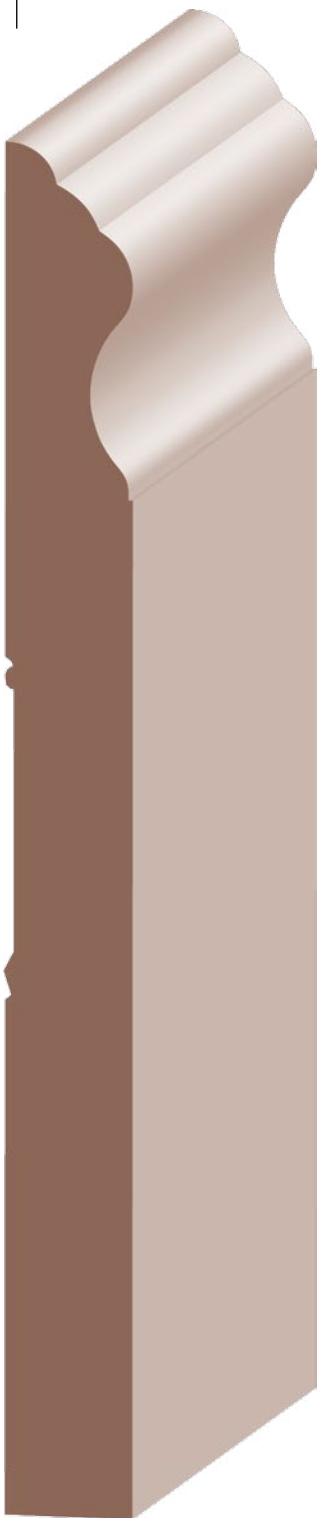

Mission Bay Base 11/16 x 7-1/4
333P Poplar

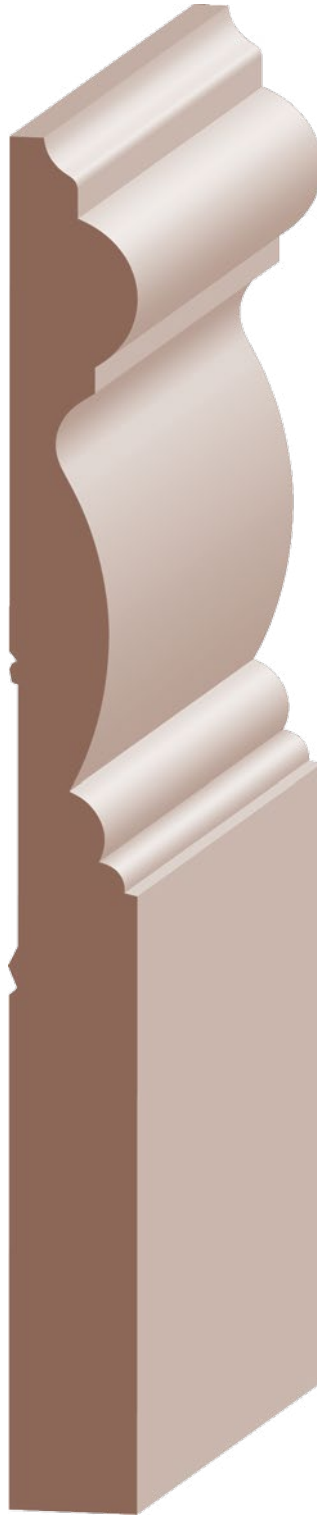

Hermosa Base 11/16 x 7-1/4
340P Poplar
340ALD Alder

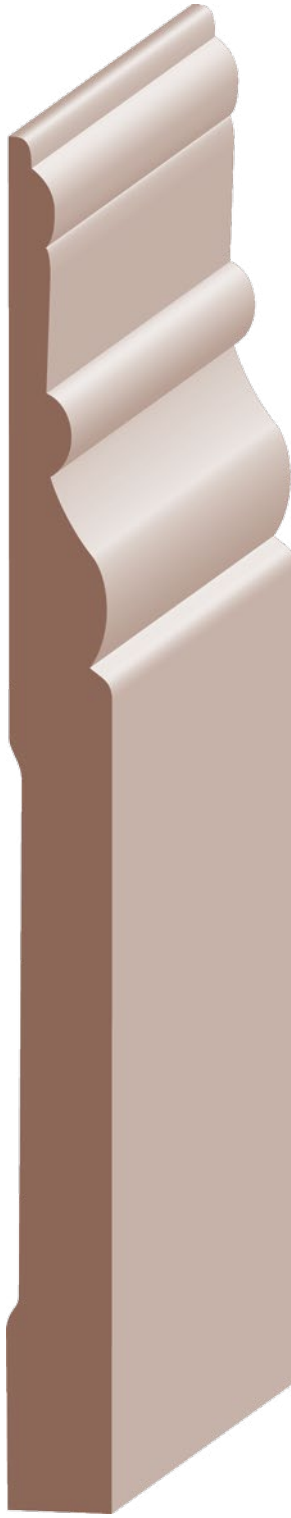

Tuscany Base 9/16 x 7-1/4
378P Poplar

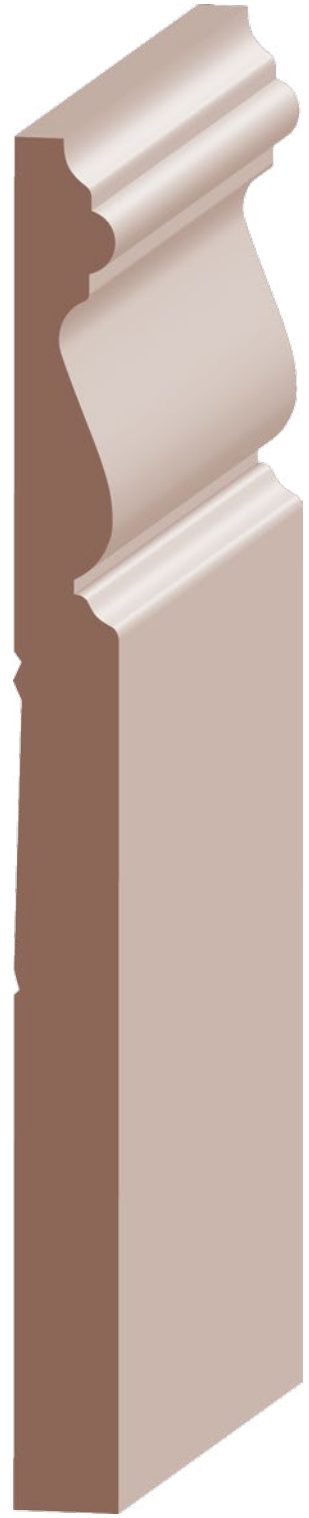

Sonoma Base 9/16 x 7-1/4
386P Poplar
386ALD Alder
386C Cherry
386MH Mahogany
386MP Maple

*Hardwood moulding is generally available in 12' and under. For lengths over 12', please check for availability.

(items are approximate scale only)

STOP



1 Round Edge Stop 3/8 x 1-1/4
202-O Oak
202P Poplar

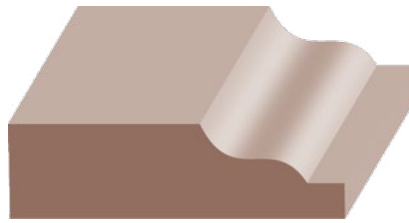

Ogee Stop 1/2 x 1-3/4
210-O Oak
210P Poplar
210ALD Alder



1 Round Edge Stop 1/2 x 1-1/2
209-O Oak
209P Poplar
209ALD Alder
209VG VG Fir
209C Cherry
209MH Mahogany
209MP Maple

1-5/8" to 2-1/4" CROWN & CORNICE

Lengths Available: 6' thru 16'

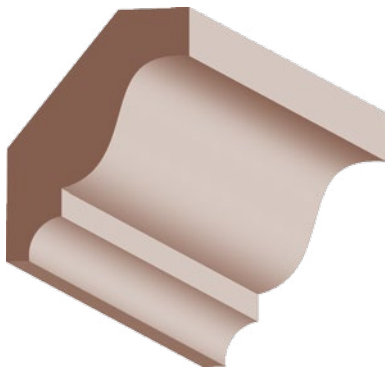

Colonial Crown 1/2 x 1-5/8
400-O Oak

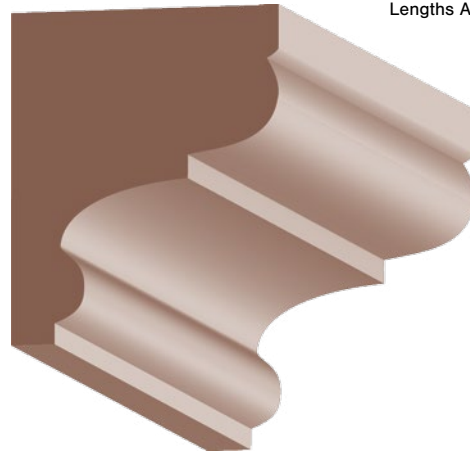

Cabinet Crown 1-7/16 x 1-3/4
403P Poplar

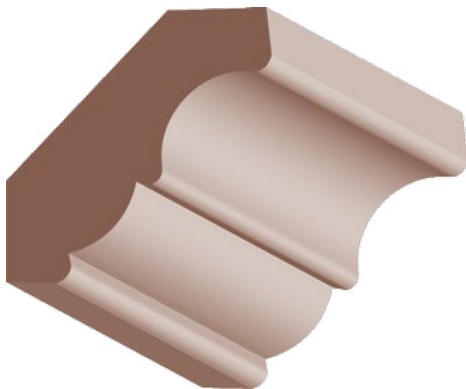

Bed Mold 9/16 x 1-7/8
420ALD Alder

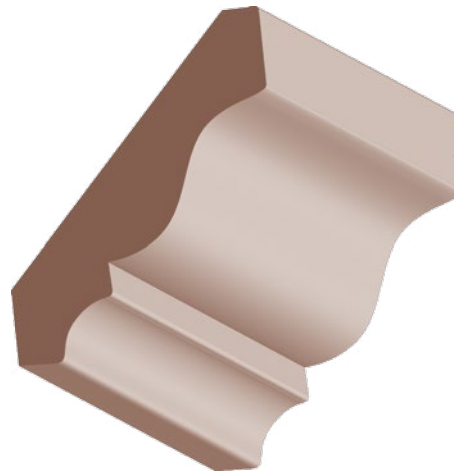

Colonial Crown 1/2 x 2-1/4
404-O Oak

*Hardwood mouldings generally are available in 12' and under. For lengths over 12', please check for availability.



2-1/4" to 3-1/4" CROWN & CORNICE

Lengths Available: 6' thru 16'

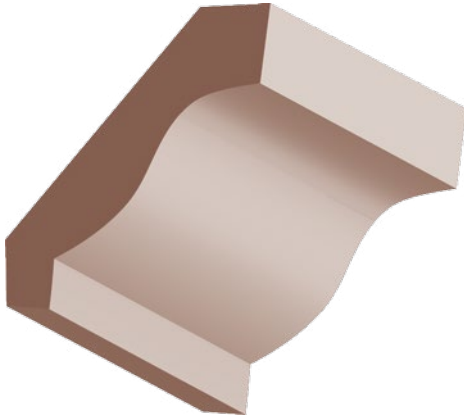

Colonial Crown	$1/2 \times 2-1/4$
401-O	Oak

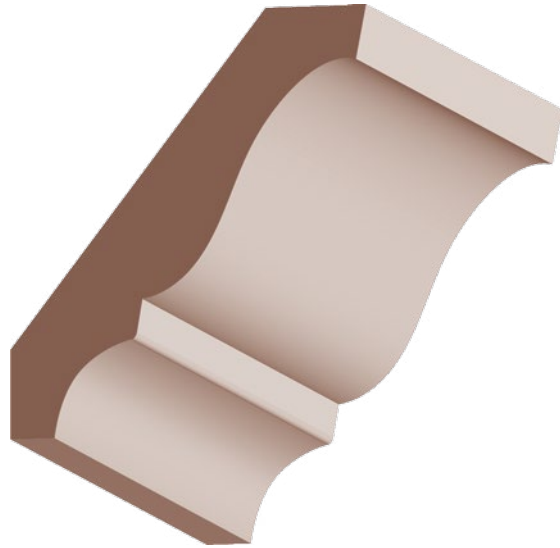

Colonial Crown	$1/2 \times 2-3/4$
436-O	Oak
436P	Poplar
436ALD	Alder
436C	Cherry
436MH	Mahogany
436MP	Maple

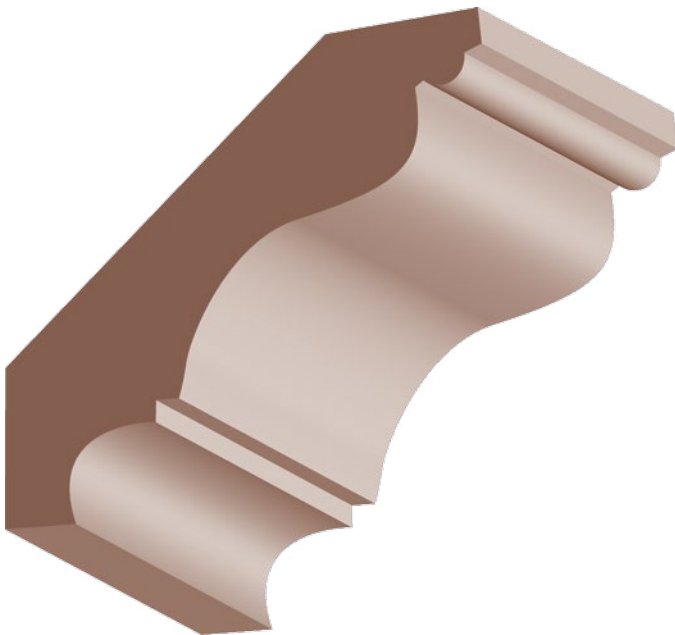

Beaded Colonial Crown	$1/2 \times 3-1/4$
405B-O	Oak
405BP	Poplar
405BC	Cherry
405BMH	Mahogany
405BMP	Maple

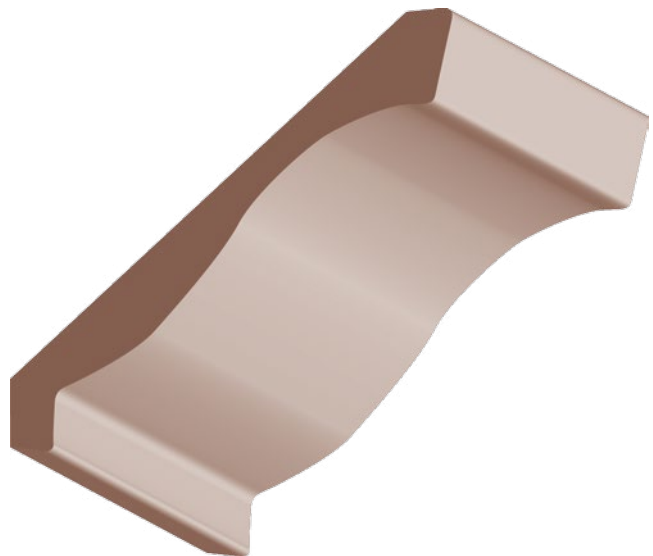

Crown	$1/2 \times 3-1/4$
402-O	Oak

*Hardwood mouldings generally are available in 12' and under. For lengths over 12', please check for availability.

(items are approximate scale only)

3-1/4" to 3-1/2" CROWN & CORNICE

Lengths Available: 6' thru 16'

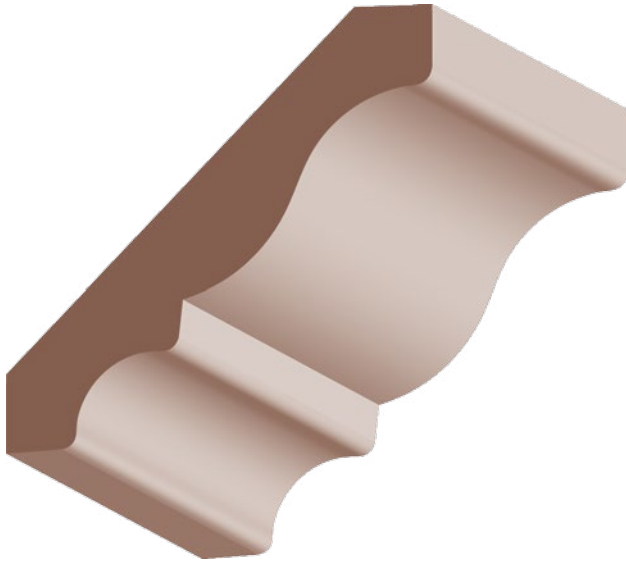

Colonial Crown	1/2 x 3-1/4
405-O	Oak
405P	Poplar
405ALD	Alder
405KA	Knotty Alder
405C	Cherry
405MH	Mahogany
405MP	Maple

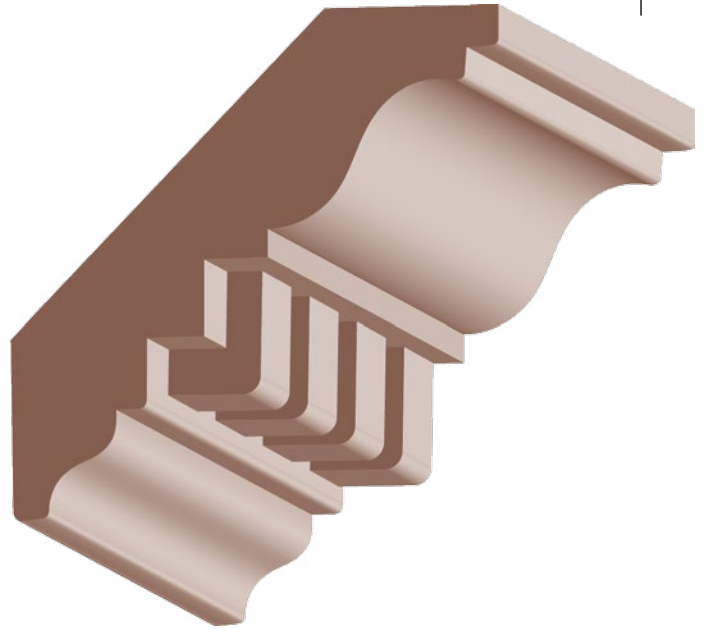

Dentil Crown	13/16 x 3-1/4
CM74-O	Oak
CM74P	Poplar
CM74ALD	Alder
CM74C	Cherry
CM74MH	Mahogany
CM74MP	Maple
405BMP	Maple

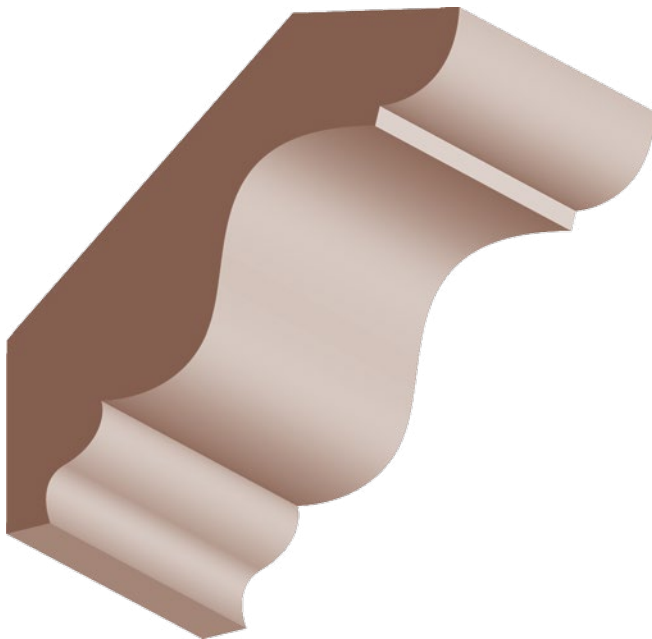

Crown	11/16 x 3-1/2
CR820P	Poplar

*Hardwood mouldings generally are available in 12' and under. For lengths over 12', please check for availability.



4-1/2" CROWN & CORNICE

Lengths Available: 6' thru 16'

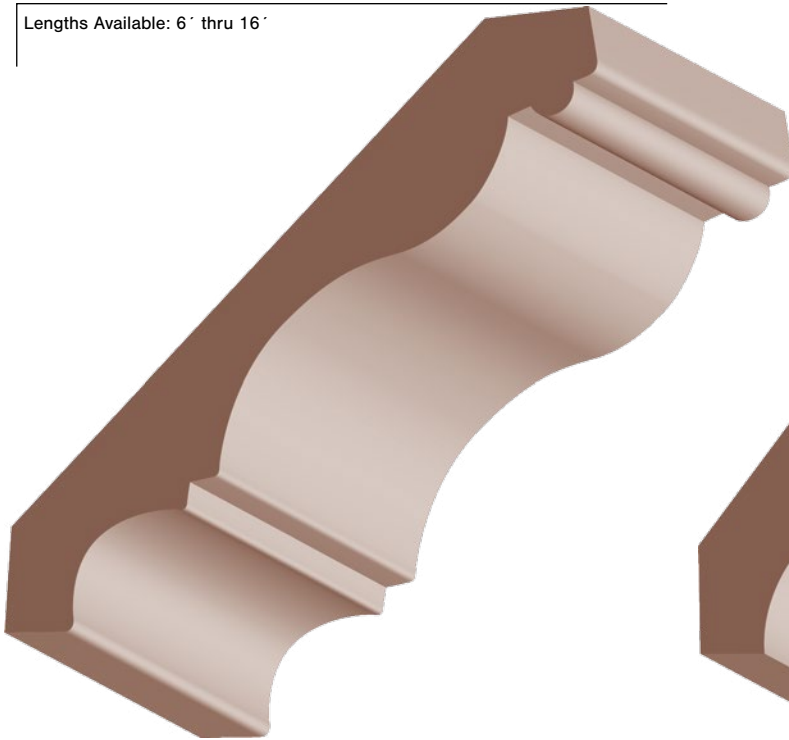

Beaded Colonial Crown

5/8 x 4-1/2

406B-O	Oak
406BP	Poplar
406BC	Cherry
406BMH	Mahogany
406BMP	Maple

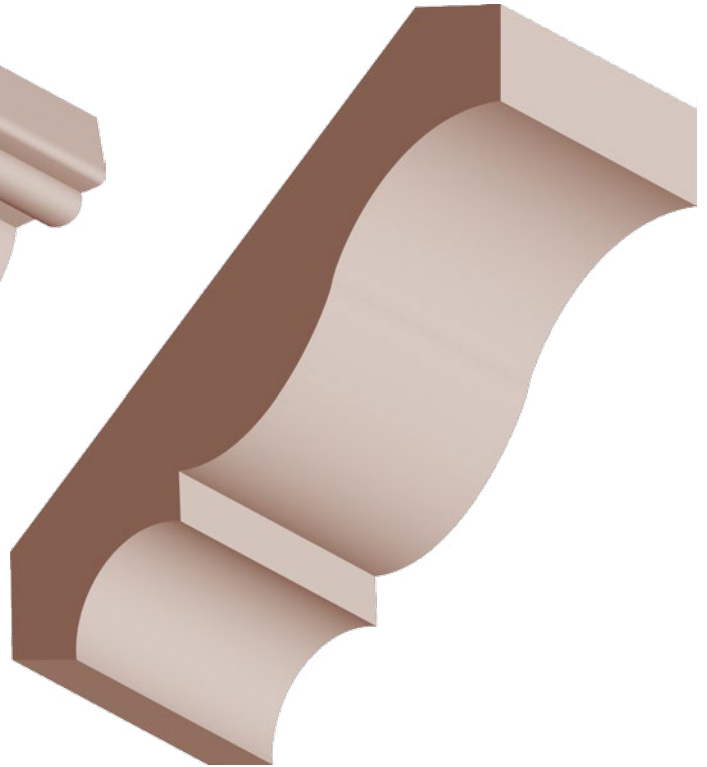

Colonial Crown

3/4 x 4-1/2

406-O	Oak
406P	Poplar
406ALD	Alder
406KA	Knotty Alder
406C	Cherry
406MH	Mahogany
406MP	Maple

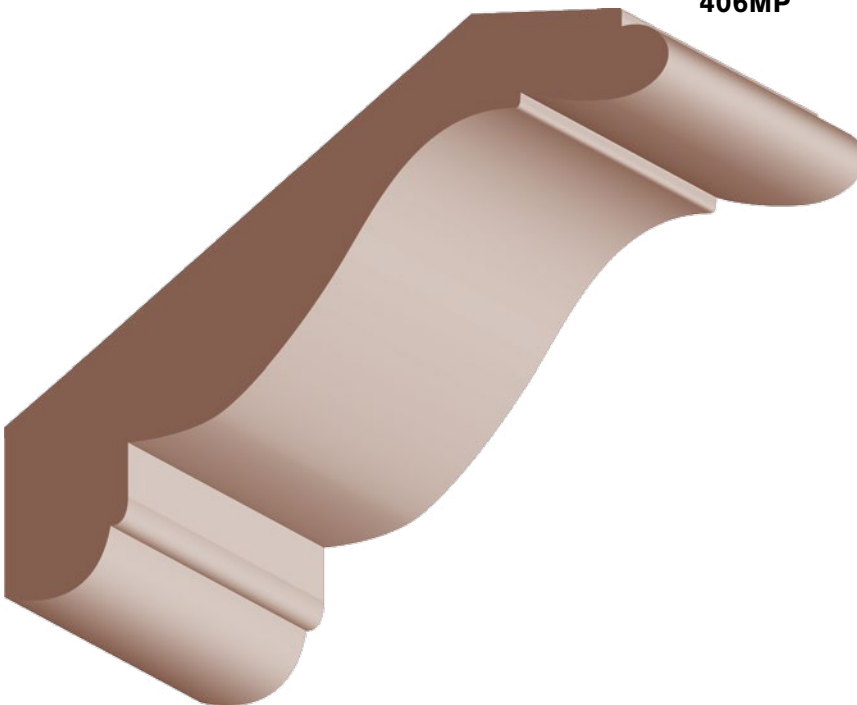

Cornice

3/4 x 4-1/2

409-O	Oak
--------------	-----

*Hardwood moulding is generally available in 12' and under. For lengths over 12', please check for availability.

(items are approximate scale only)

4-1/2" to 5" CROWN & CORNICE

Lengths Available: 6' thru 16'

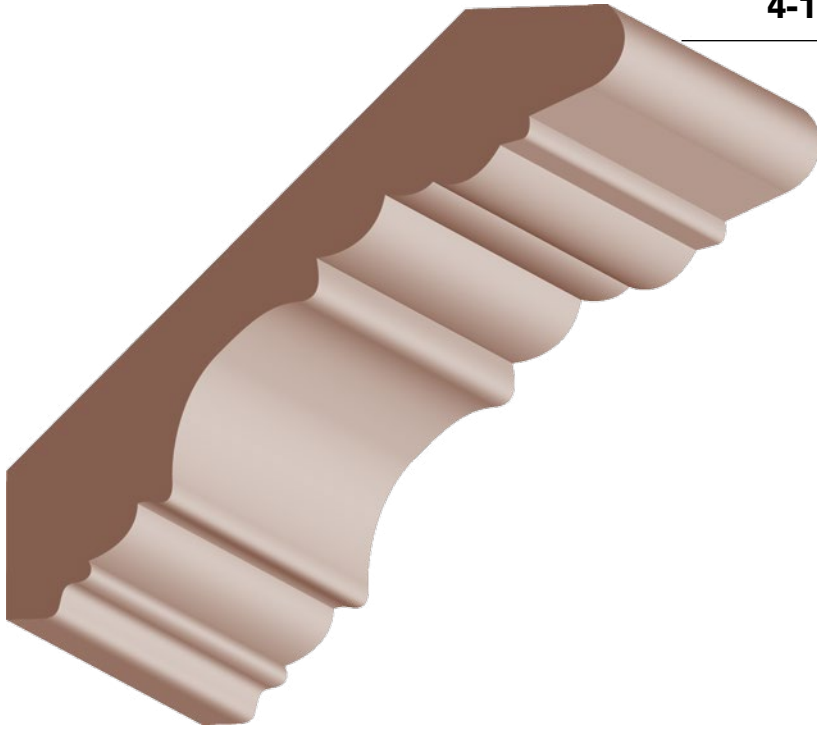

Georgian Crown	3/4 x 4-1/2
412-0	Oak
412P	Poplar
412ALD	Alder
412C	Cherry
412MH	Mahogany
412MP	Maple

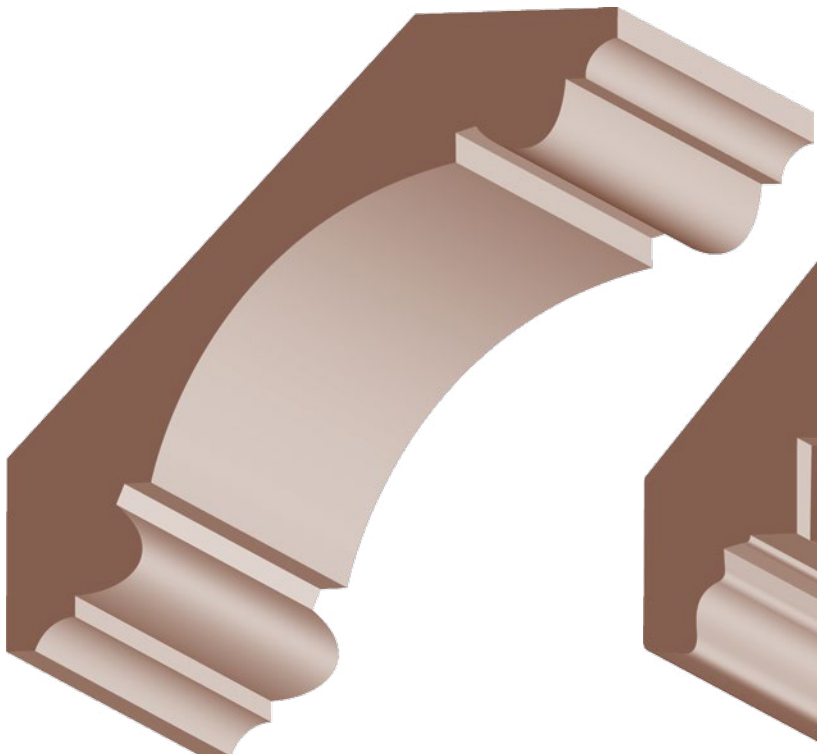

Carolina Crown	7/8 x 4-5/8
423P	Poplar
423ALD	Alder

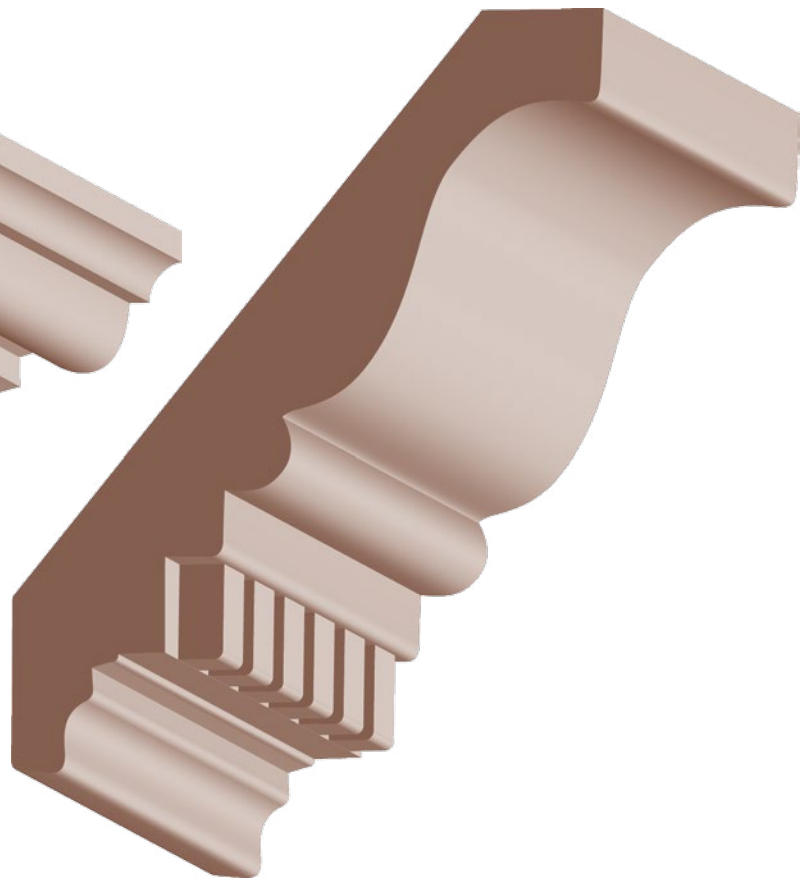

Dentil Crown	3/4 x 5
CR864P	Poplar



5-1/4" CROWN & CORNICE

Lengths Available: 6' thru 16'

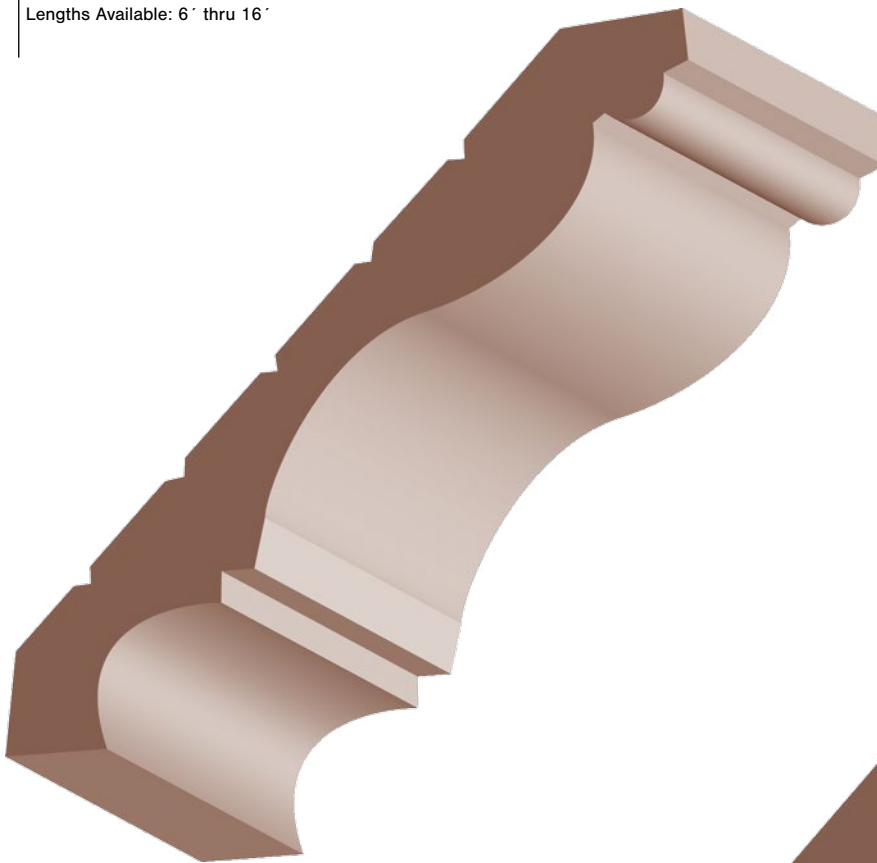

Beaded Colonial Crown

3/4 x 5-1/4

414B-O	Oak
414BP	Poplar
414BALD	Alder
414BC	Cherry
414BMH	Mahogany
414BMP	Maple

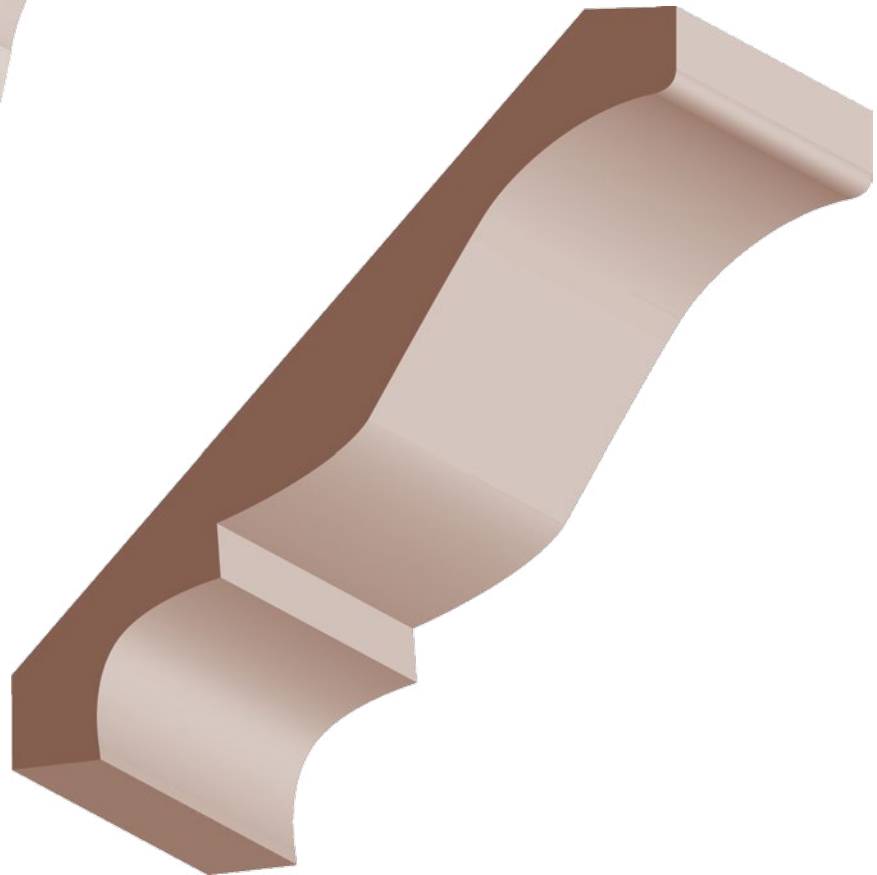

Colonial Crown

3/4 x 5-1/4

414-O	Oak
414P	Poplar
414ALD	Alder
414KA	Knotty Alder
414C	Cherry
414MH	Mahogany
414MP	Maple

*Hardwood mouldings generally are available in 12' and under. For lengths over 12', please check for availability.

(items are approximate scale only)

5-1/4" to 5-1/2" CROWN & CORNICE

Lengths Available: 6' thru 16'



Madison Crown 13/16 x 5-1/4
CO705P Poplar

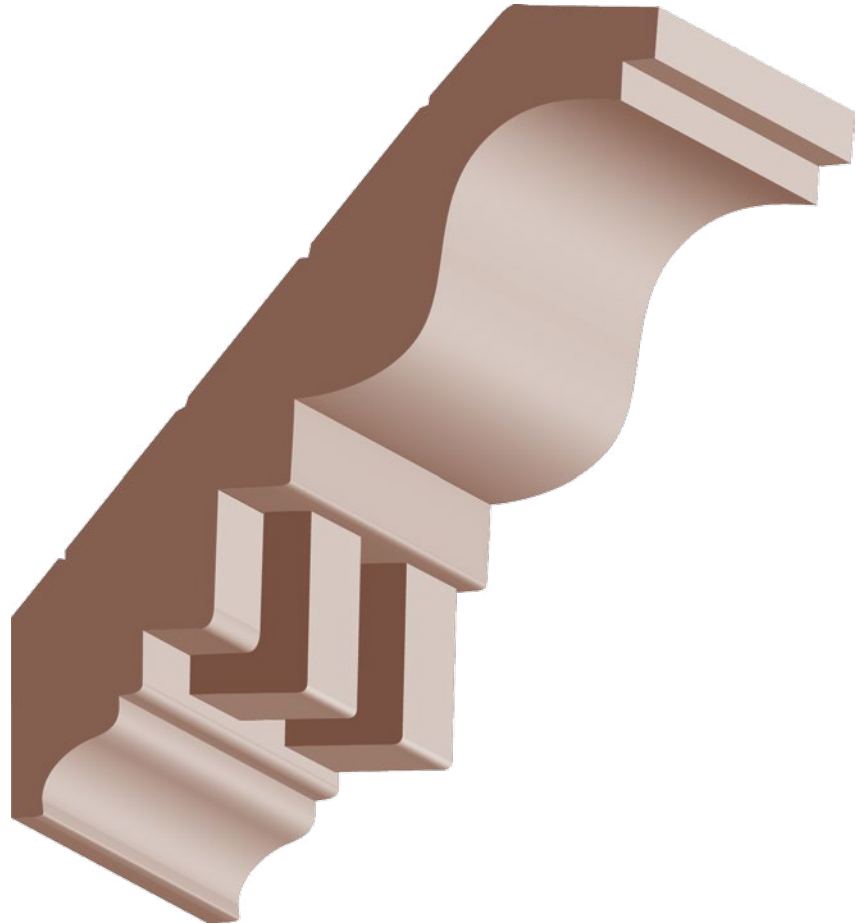

Dentil Crown 13/16 x 5-1/2
CM73-O Oak
CM73P Poplar
CM73ALD Alder
CM73C Cherry
CM73MH Mahogany
CM73MP Maple

*Hardwood mouldings generally are available in 12' and under. For lengths over 12', please check for availability.



5-1/2" CROWN & CORNICE

Lengths Available: 6' thru 16'

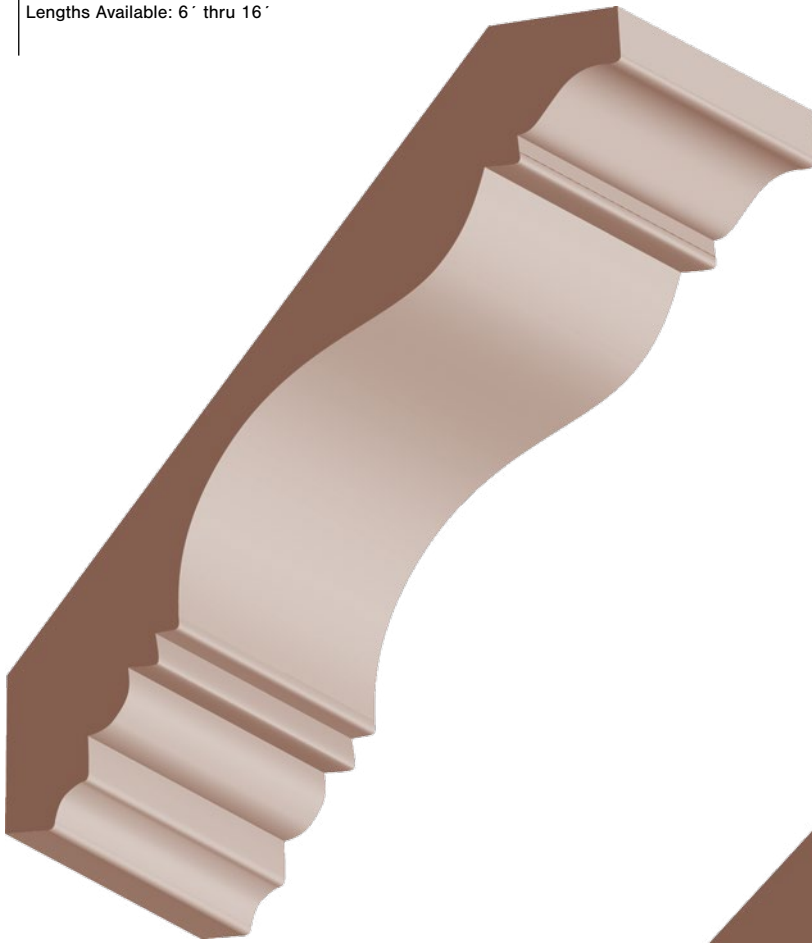

Covington Crown 11/16 x 5-1/2
CR806P Poplar

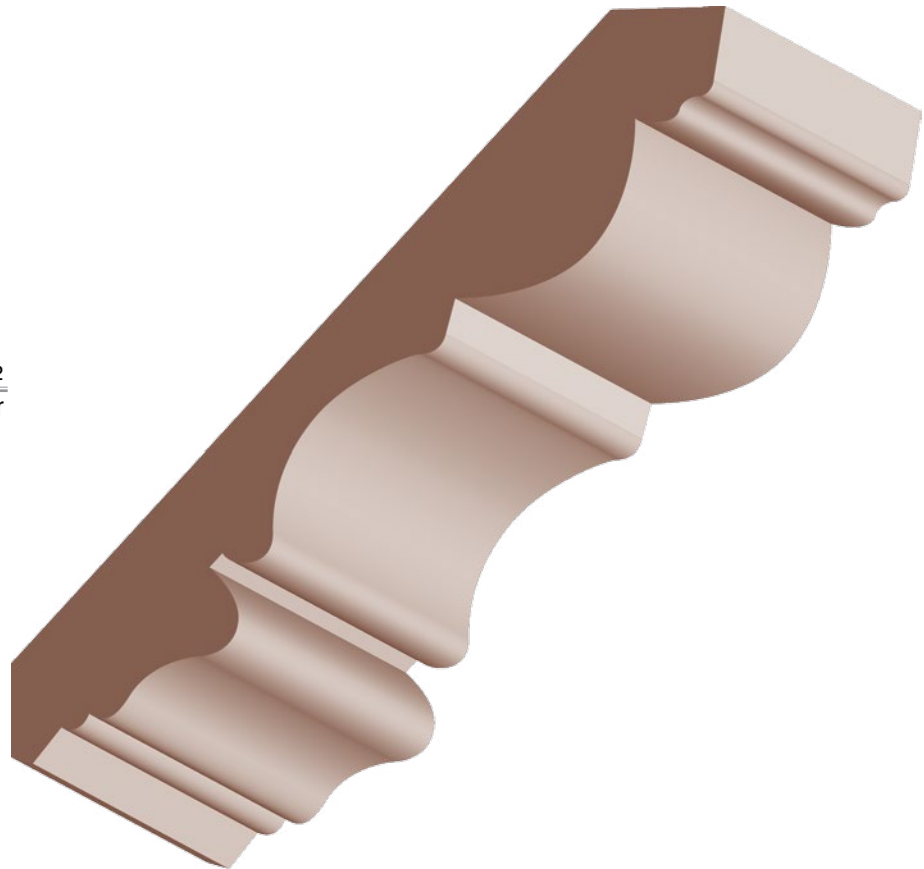

Lancaster Crown 13/16 x 5-1/2
CR830P Poplar

*Hardwood mouldings generally are available in 12' and under. For lengths over 12', please check for availability.

(items are approximate scale only)

5-1/2" to 6" CROWN & CORNICE

Lengths Available: 6' thru 16'

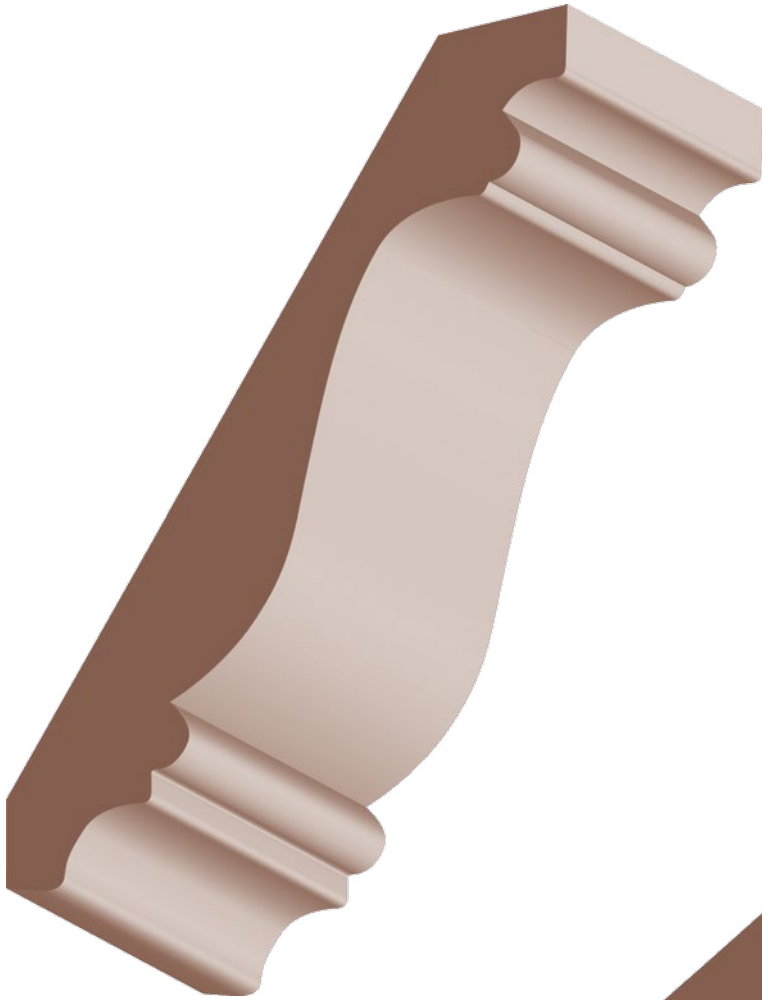

Pembroke Crown 1 1/16 x 5-1/2
CR880P Poplar

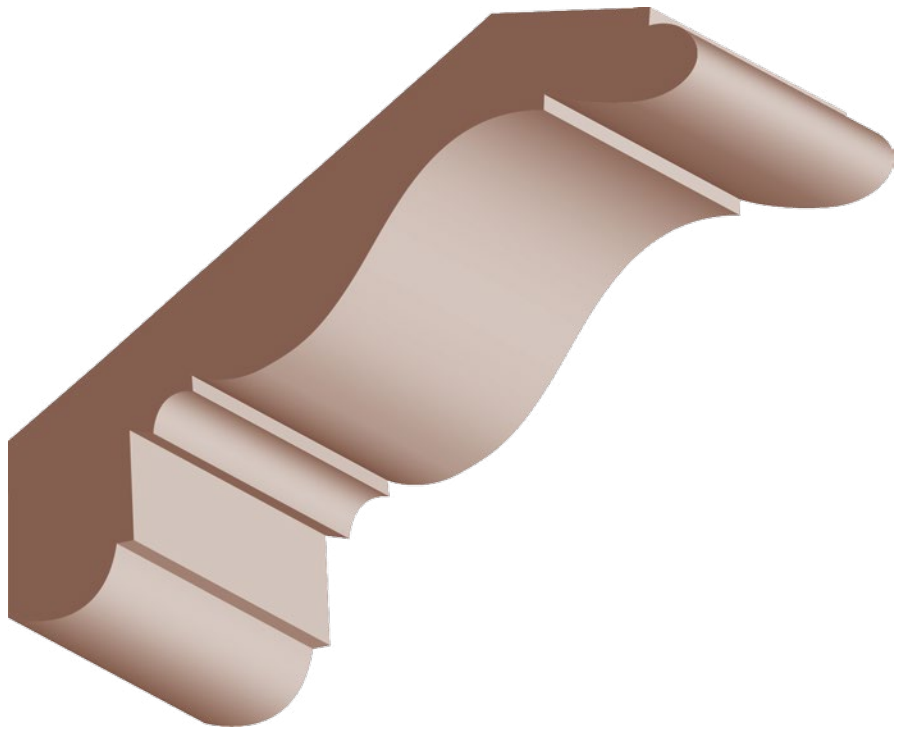

Cornice 1-1/8 x 6
408-O Oak
408P Poplar
408C Cherry
408MH Mahogany
408MP Maple

*Hardwood mouldings generally are available in 12' and under. For lengths over 12', please check for availability.



6" to 6-1/4" CROWN & CORNICE

Lengths Available: 6' thru 16'

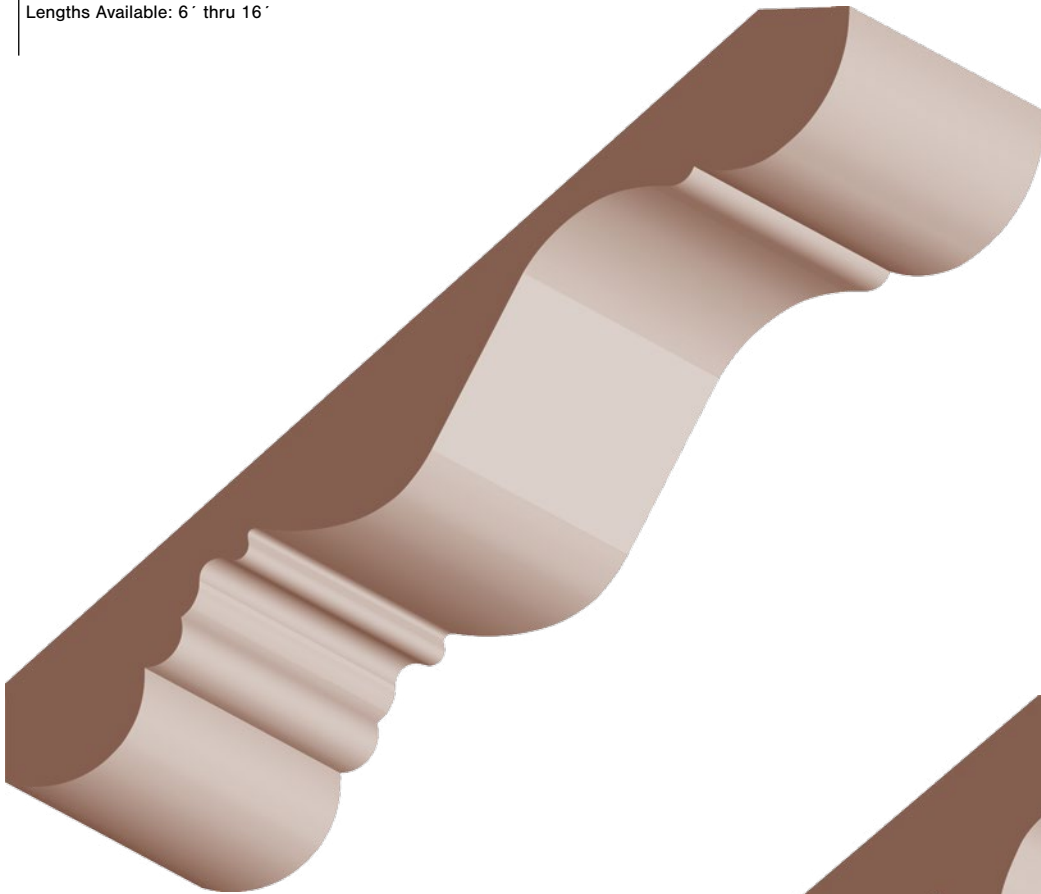

Crown	<u>3/4 x 6</u>
410-0	Oak
410P	Poplar
410ALD	Alder
410KA	Knotty Alder
410C	Cherry
410MH	Mahogany
410MP	Maple

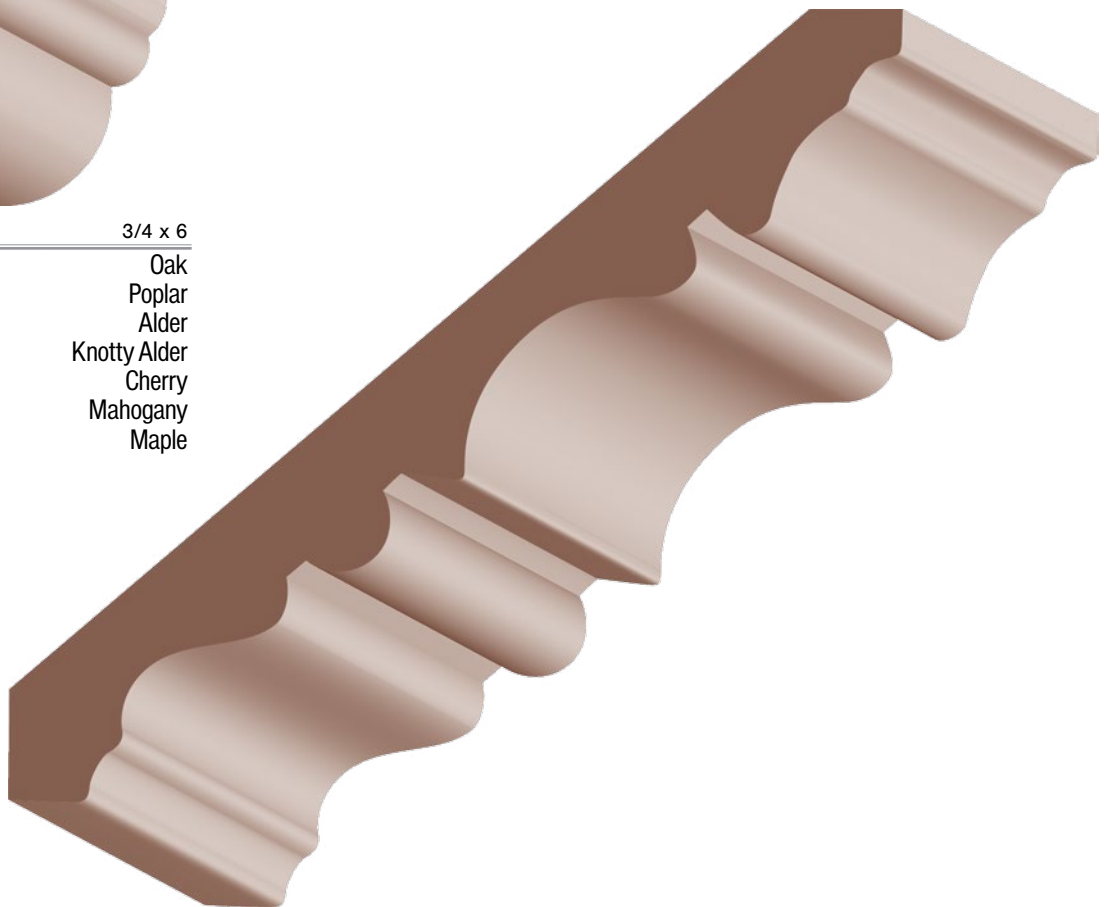

Fredericksburg Crown	<u>11/16 6 1/4</u>
CR841P	Poplar

*Hardwood mouldings generally are available in 12' and under. For lengths over 12', please check for availability.

(items are approximate scale only)

6-1/2" CROWN & CORNICE

Lengths Available: 6' thru 16'

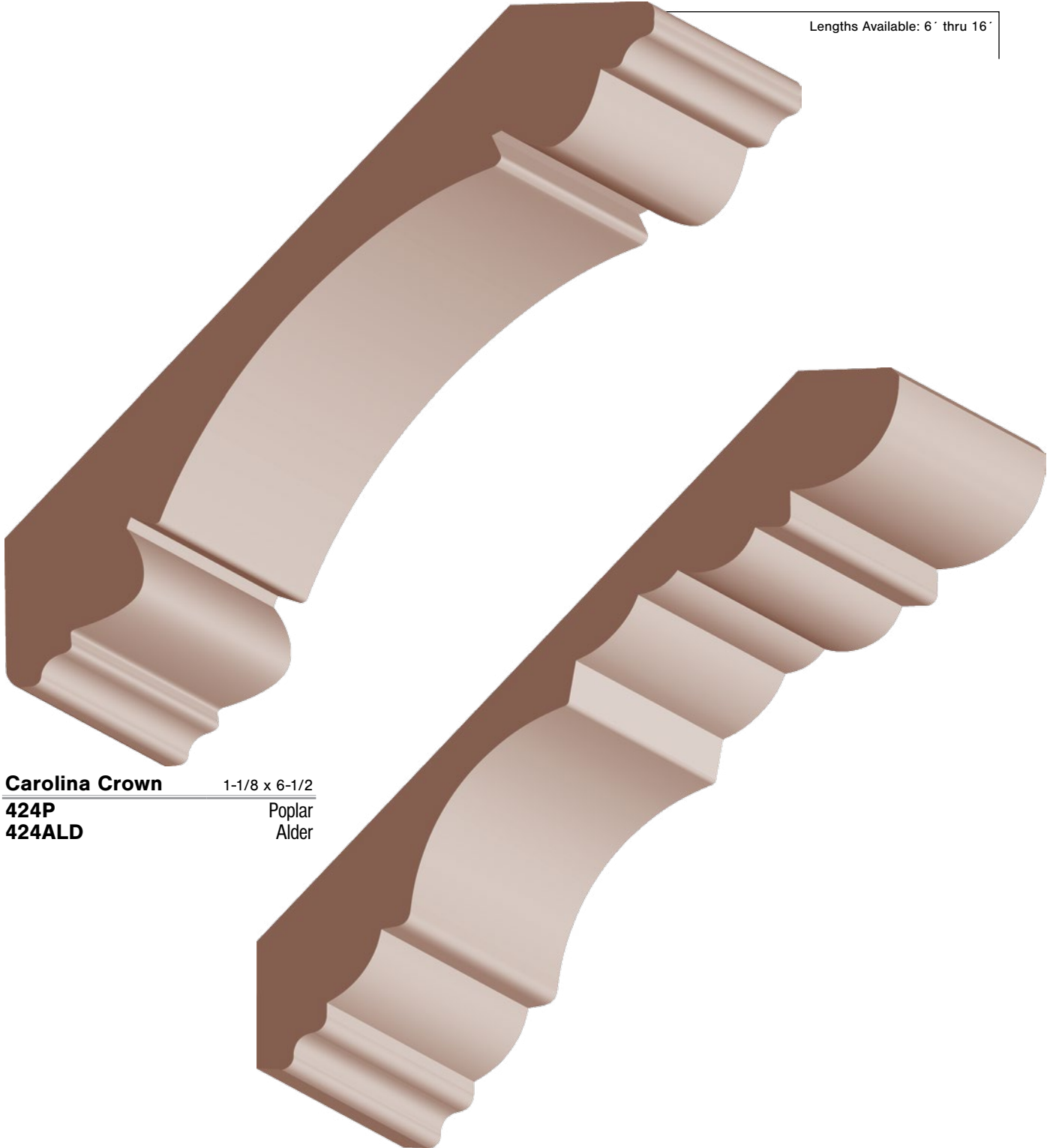

Carolina Crown	1-1/8 x 6-1/2
424P	Poplar
424ALD	Alder

Georgian Crown	7/8 x 6-1/2
427-0	Oak
427P	Poplar
427ALD	Alder
427C	Cherry
427MH	Mahogany
427MP	Maple

*Hardwood mouldings generally are available in 12' and under. For lengths over 12', please check for availability.



6-1/2" to 7" CROWN & CORNICE

Lengths Available: 6' thru 16'

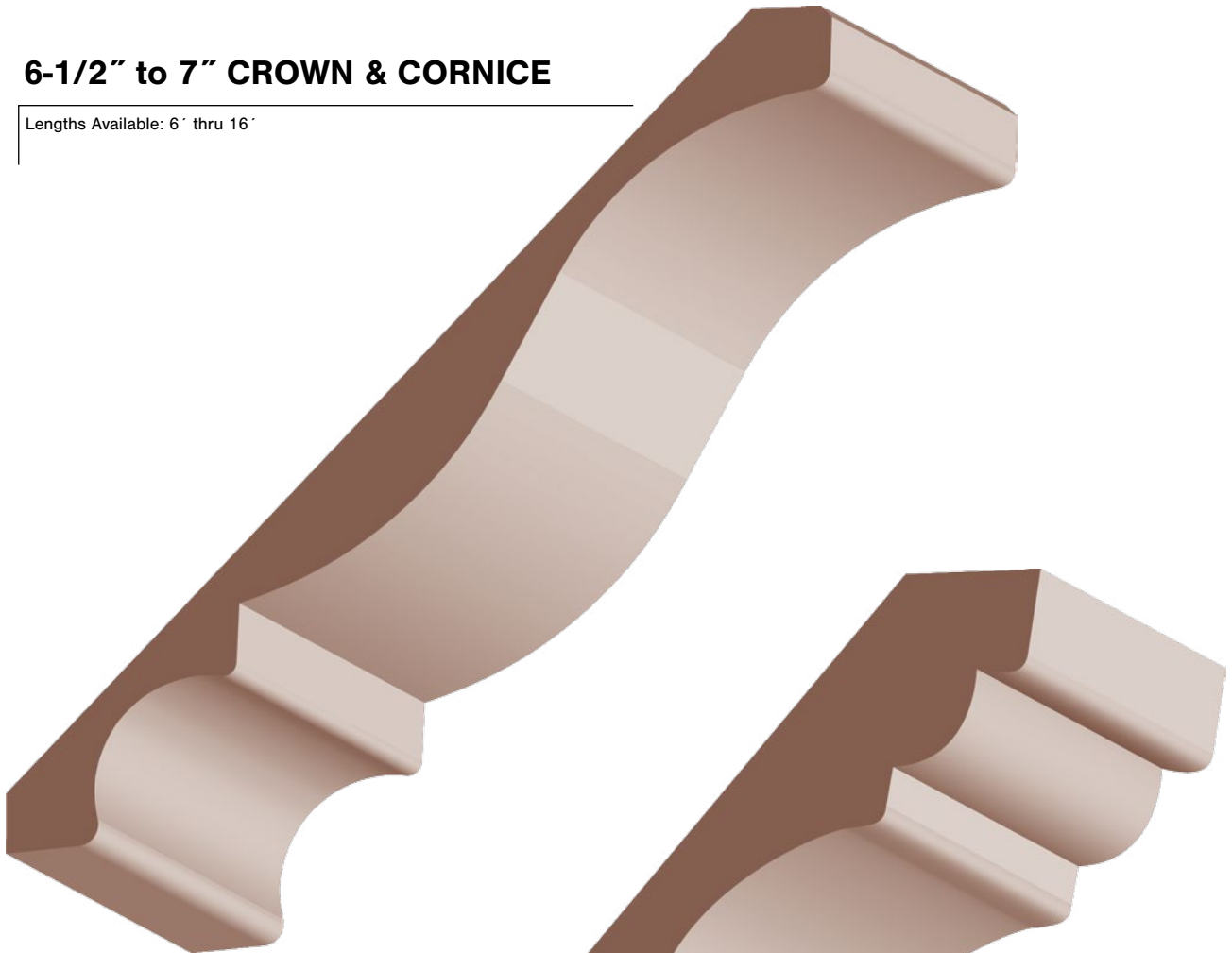

Colonial Crown 3/4 x 6-1/2
416P Poplar

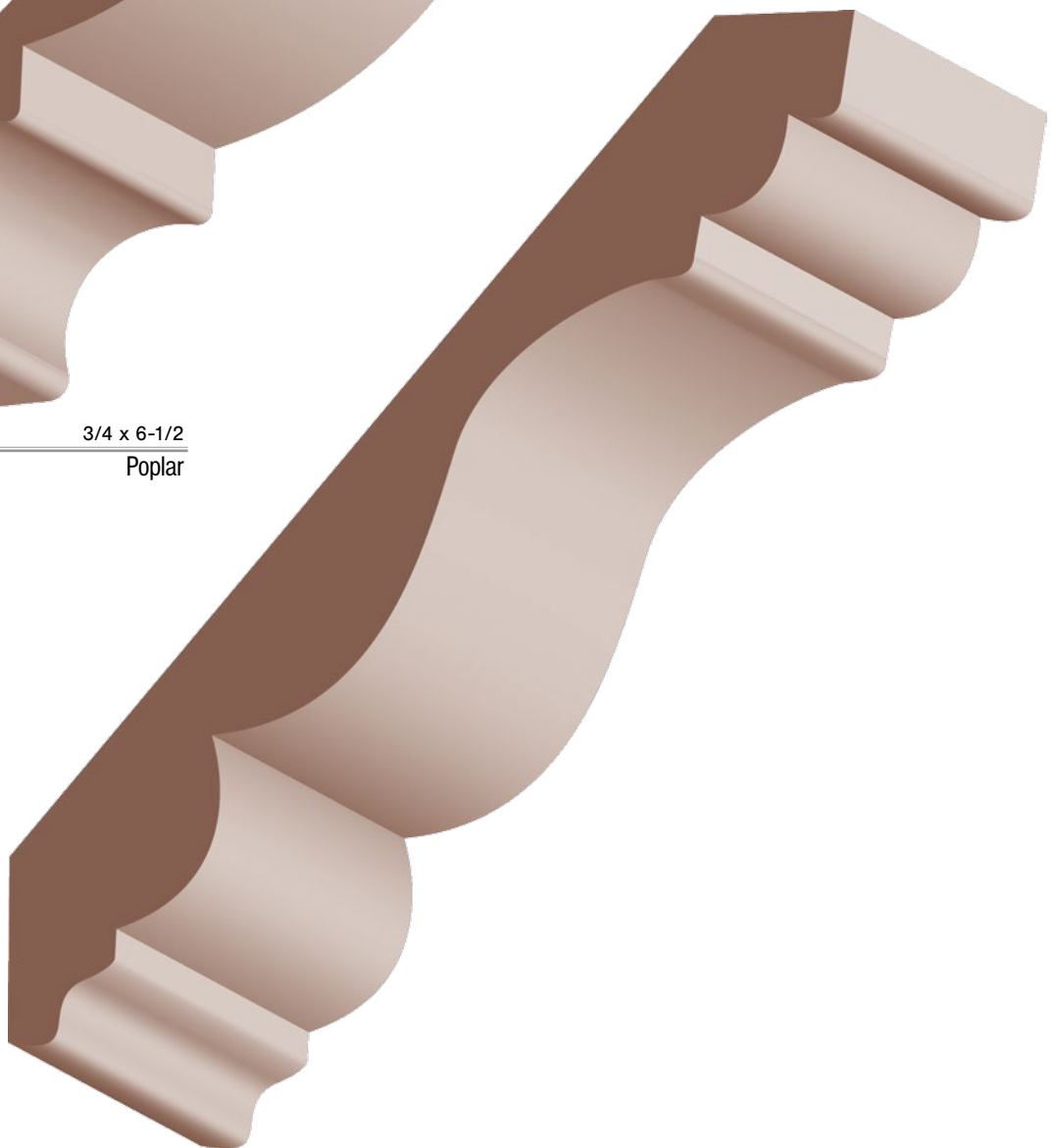

Bel-Air Crown 13/16 x 7
CR800P Poplar

*Hardwood mouldings generally are available in 12' and under. For lengths over 12', please check for availability.

(items are approximate scale only)

7" to 7-1/8" CROWN & CORNICE

Lengths Available: 6' thru 16'

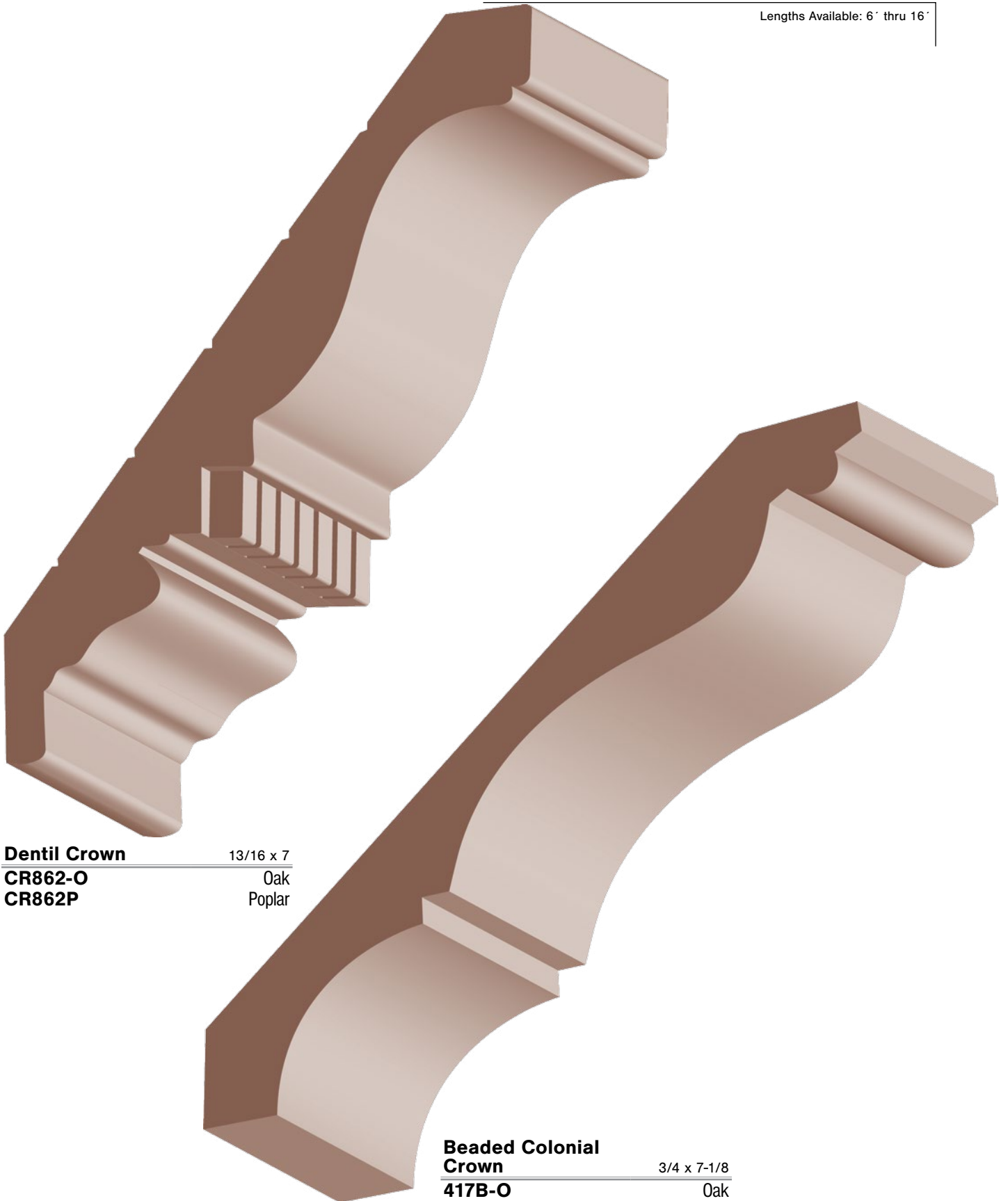

Dentil Crown $\frac{13}{16} \times 7$
CR862-O Oak
CR862P Poplar

Beaded Colonial Crown $\frac{3}{4} \times 7\text{-}1/8$
417B-O Oak

*Hardwood mouldings generally are available in 12' and under. For lengths over 12', please check for availability.



7-1/4" CROWN & CORNICE

Lengths Available: 6' thru 16'

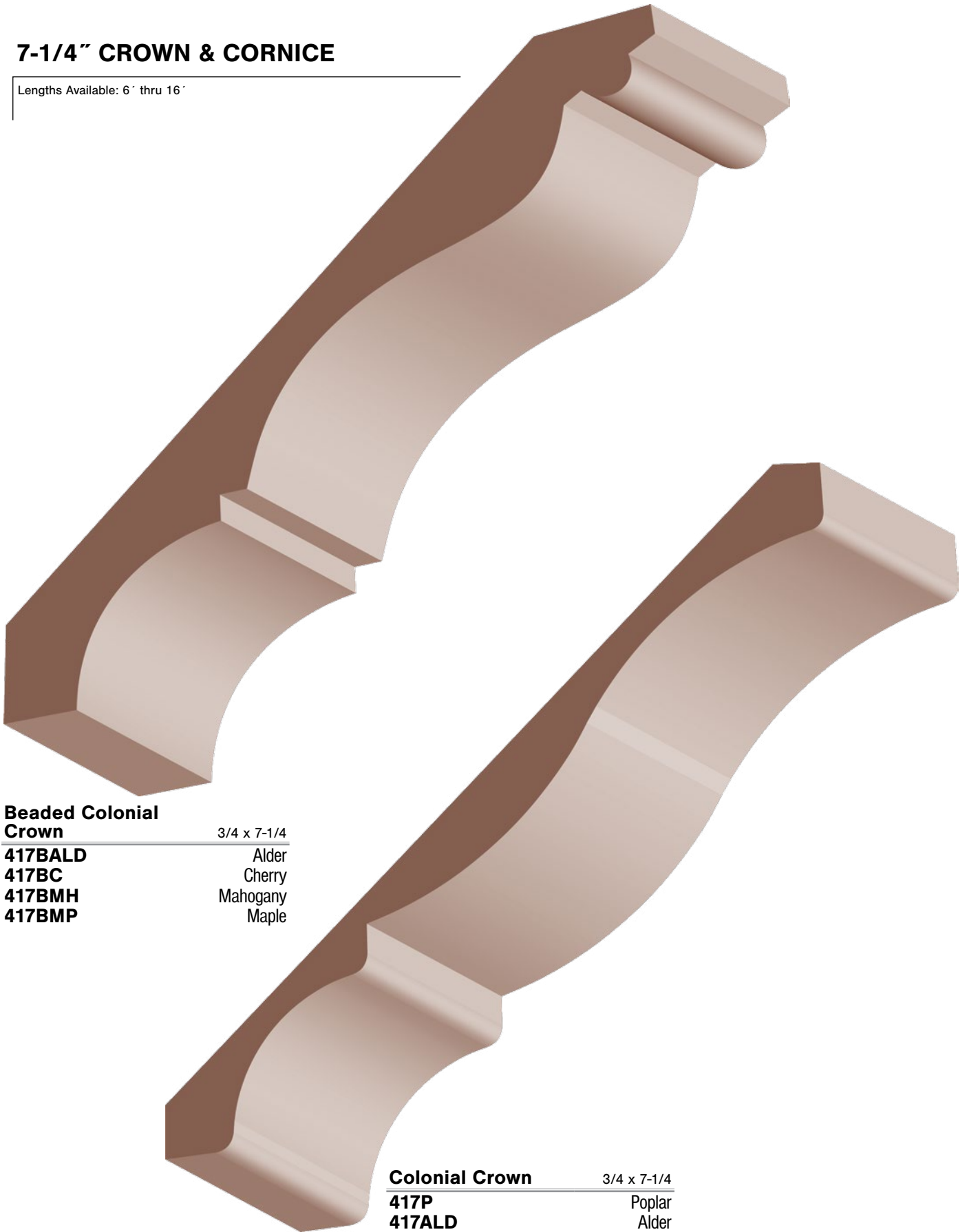

Beaded Colonial Crown

- 417BALD**
- 417BC**
- 417BMH**
- 417BMP**

3/4 x 7-1/4
 Alder
 Cherry
 Mahogany
 Maple

Colonial Crown

- 417P**
- 417ALD**

3/4 x 7-1/4
 Poplar
 Alder

*Hardwood mouldings generally are available in 12' and under. For lengths over 12', please check for availability.

(items are approximate scale only)

8" CROWN & CORNICE

Lengths Available: 6' thru 16'

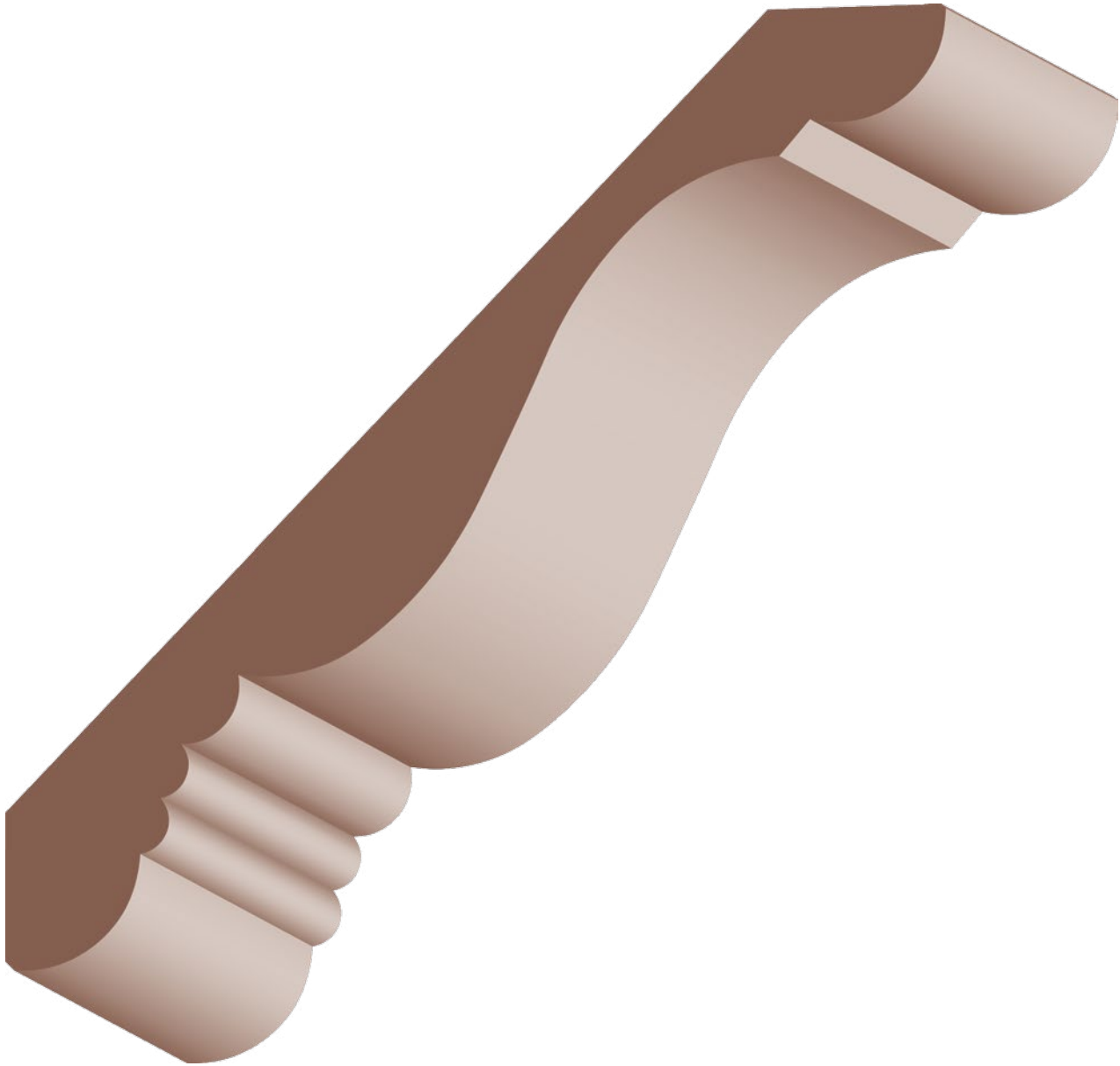

Large #410 Crown	1 x 8
450P	Poplar
450C	Cherry
450MH	Mahogany
450MP	Maple

*Hardwood mouldings generally are available in 12' and under. For lengths over 12', please check for availability.



9-5/8" CROWN & CORNICE

Lengths Available: 6' thru 16'

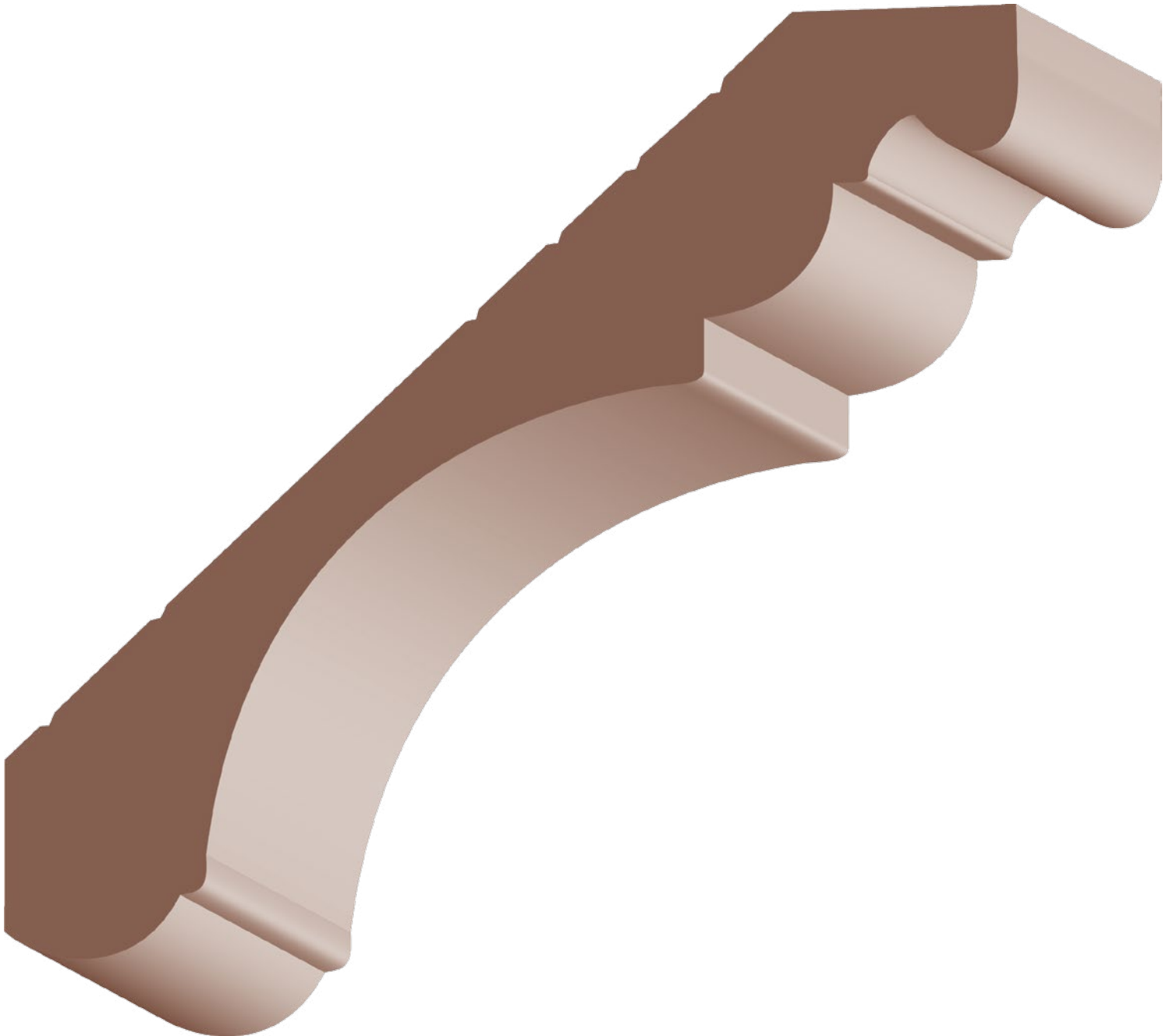

Hampton Crown 1-58 x 9-5/8
437P Poplar

*Hardwood mouldings generally are available in 12' and under. For lengths over 12', please check for availability.

(items are approximate scale only)

DENTAL LINEAL

Lengths Available: 6' thru 16'



Small Dentil $5/8 \times 1/2$ (1/4" Gap)
DE73P Poplar



Dentil $1/2 \times 1/2$
DE168P Poplar



Dentil $3/4 \times 1$
DE169P Poplar



Large Dentil $15/16 \times 5/8$ (3/4" Gap)
DE74P Poplar

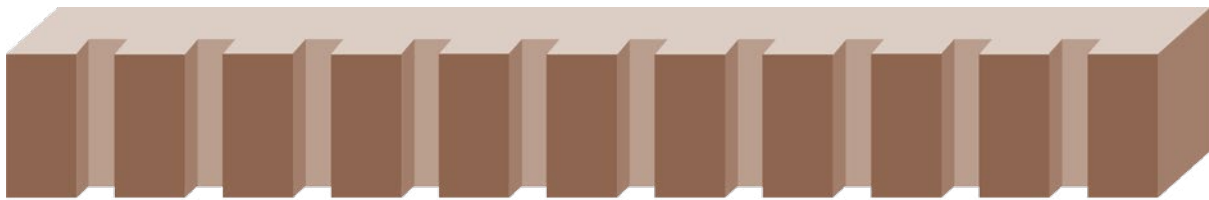

Dentil $5/8 \times 1-1/2$
DE170P Poplar



Dentil $3/4 \times 2$
DE171-O Oak
DE171P Poplar

*Hardwood mouldings generally are available in 12' and under. For lengths over 12', please check for availability.



CHAIR RAIL

Lengths Available: 6' thru 16'

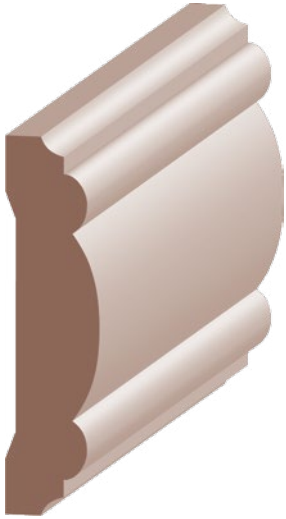

Chair Rail
648-O
648P

$1/2 \times 2$
Oak
Poplar

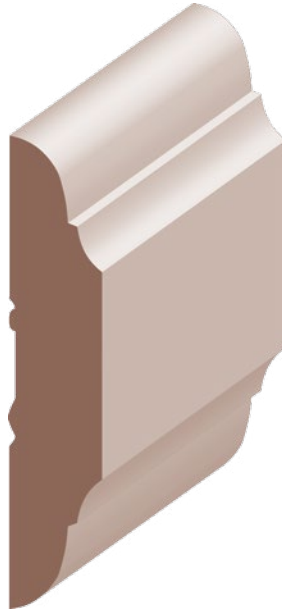

Chair Rail
651-O

$1/2 \times 2-1/2$
Oak

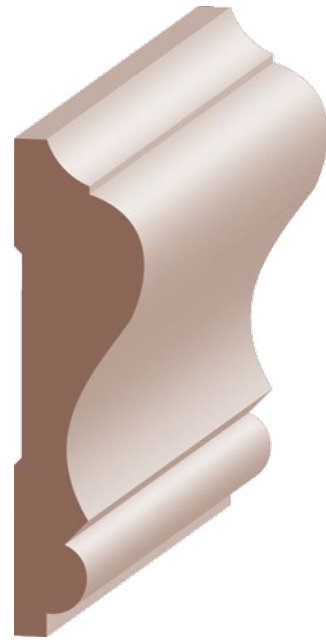

Colonial Chair Rail
652-O

$11/16 \times 2-5/8$
Oak

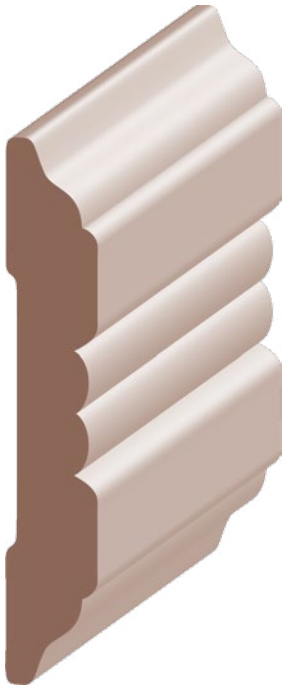

Beaded Chair Rail
654-O

$1/2 \times 2-7/8$
Oak

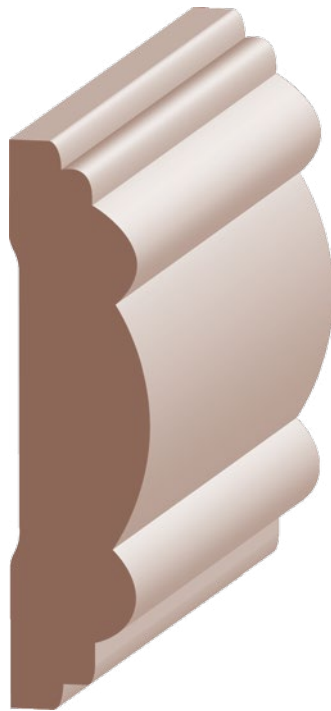

**Bead & Barrel
Chair Rail**
649P
649ALD

$3/4 \times 3$
Poplar
Alder

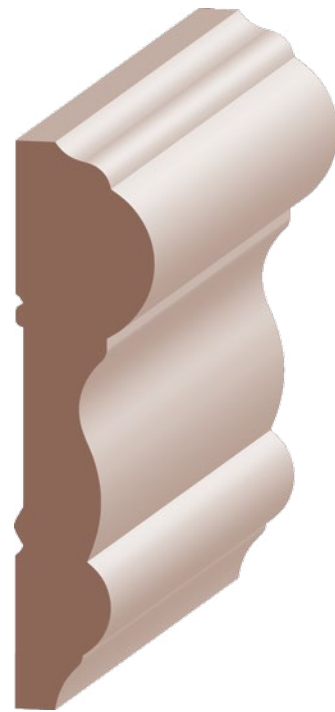

Colonial Chair Rail
653-O
653P
653C
653MH
653MP

$3/4 \times 3$
Oak
Poplar
Cherry
Mahogany
Maple

*Hardwood mouldings generally are available in 12' and under. For lengths over 12', please check for availability.

(items are approximate scale only)

CHAIR RAIL

Lengths Available: 6' thru 16'

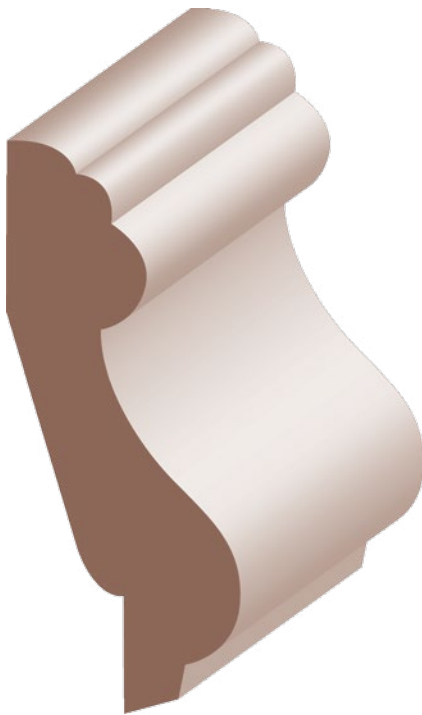

Chair Rail (w/1/2" Rab't) 3/4 x 3
654P Poplar

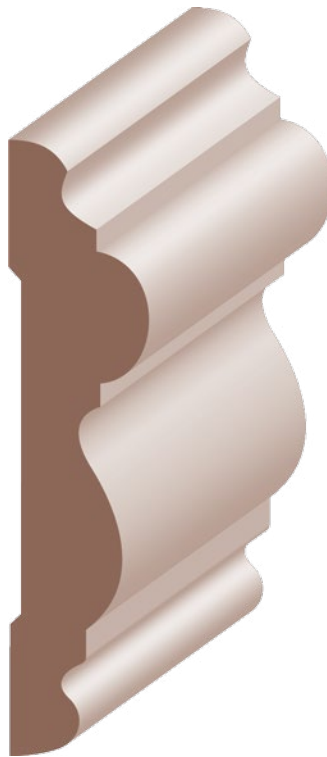

Chair Rail 3/4 x 3-1/4
656P Poplar

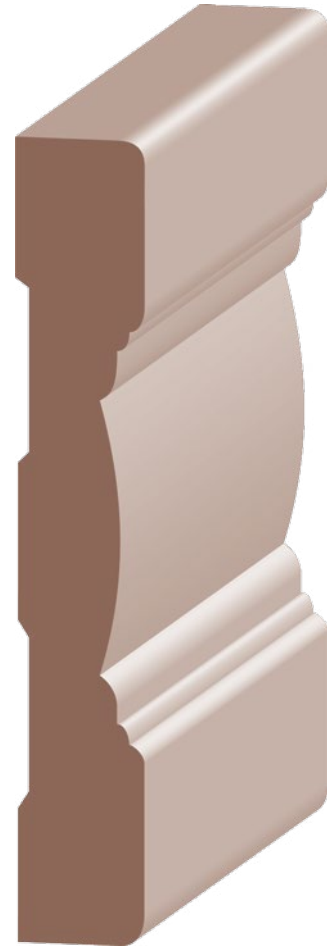

Victorian Chair Rail 11/16 x 4-1/4
184-O Oak

*Hardwood mouldings generally are available in 12' and under. For lengths over 12', please check for availability.



HANDRAIL

Lengths Available: 6' thru 16'

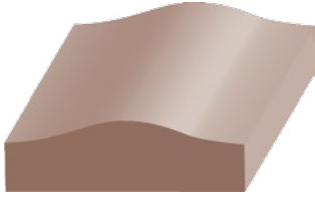

Fillet	<u>3/8 x 1-1/4</u>
951-O	Oak
951P	Poplar

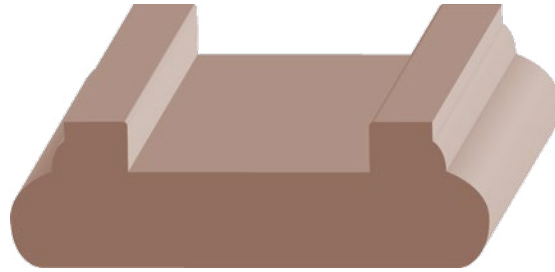

Shoe Rail	<u>3/4 x 2-1/2</u>
<i>w/1/4" x 1-1/4" Plow</i>	
950-O	Oak
950P	Poplar

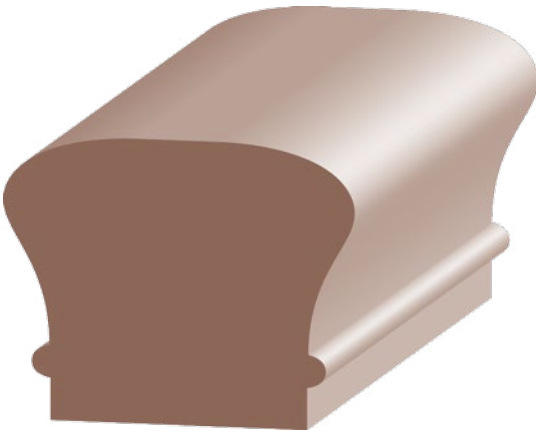

Small 6010 Handrail	<u>1-1/2 x 1-7/8</u>
932P	Poplar

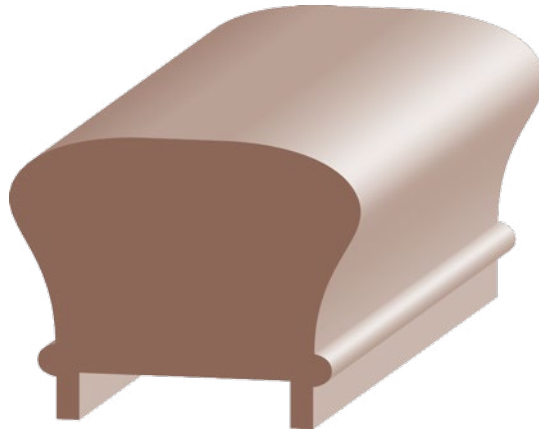

Small 6010 Handrail	<u>1-1/2 x 1-7/8</u>
<i>w/1/4" x 1-1/8" Plow</i>	
932PP	Poplar

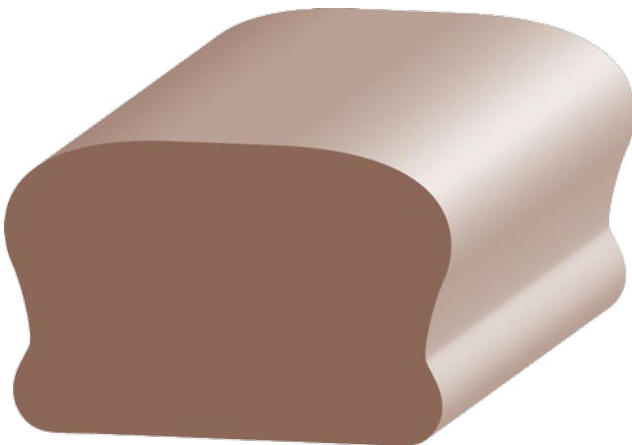

Standard Handrail	<u>1-1/2 x 2-3/8</u>
925-O	Oak

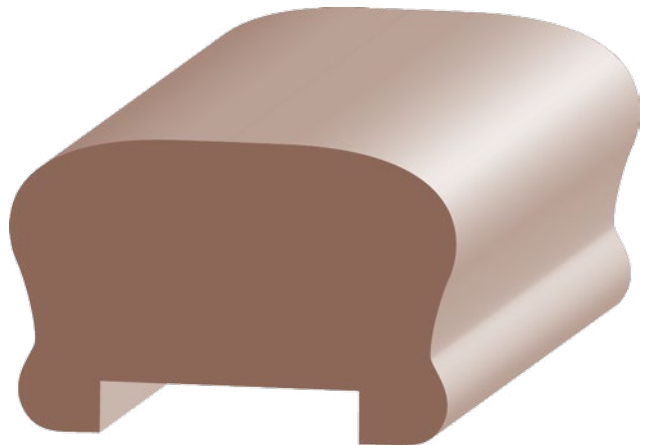

Standard Handrail	<u>1-1/2 x 2-3/8</u>
<i>(w/1/4" x 1-1/4" Plow)</i>	
925-OP	Oak

*Hardwood mouldings generally are available in 12' and under. For lengths over 12', please check for availability.

(items are approximate scale only)

HANDRAIL

Lengths Available: 6' thru 16'

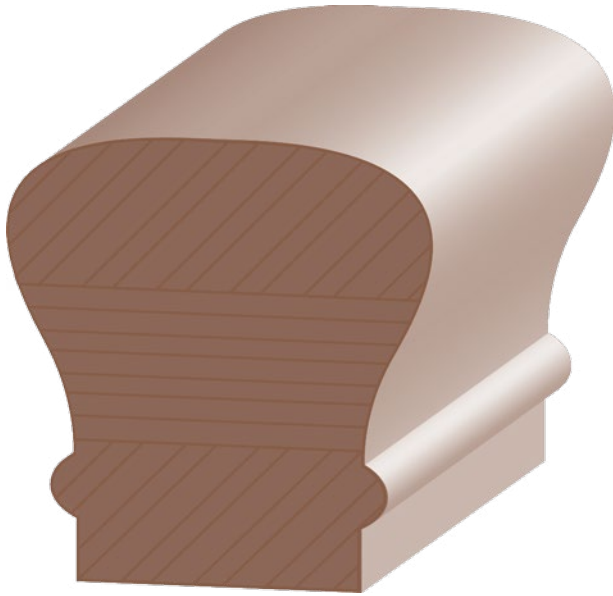

**Classic 6010
Handrail** (3pc Glue Up) 2-1/4 x 2-3/8
931P Poplar

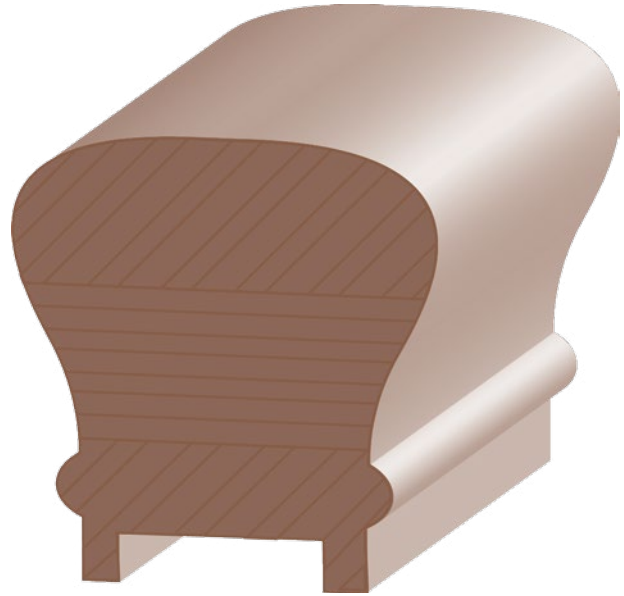

**Classic 6010
Handrail w/ Plow**
(3pc Glue Up) 2-1/4 x 2-3/8
931PP Poplar

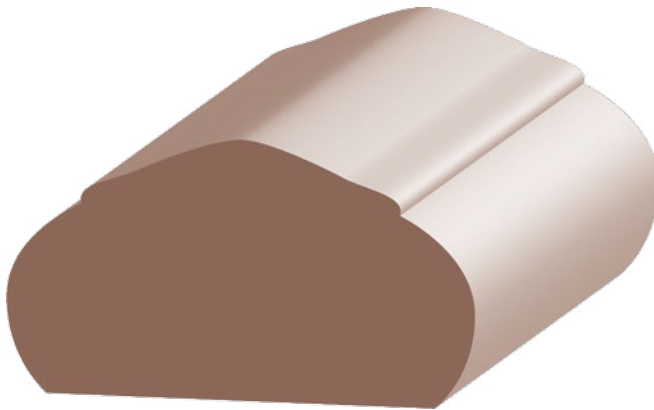

"B" Handrail 1-3/8 x 2-1/2
928-O Oak

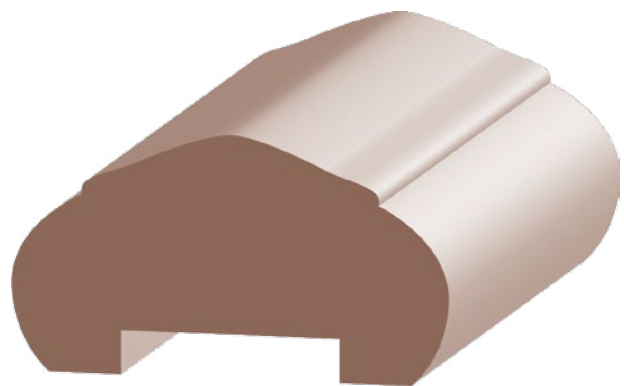

**"B" Handrail
w/ 1/4" x 1-1/4" Plow** 1-3/8 x 2-1/2
928-OP Oak

*Hardwood mouldings generally are available in 12' and under. For lengths over 12', please check for availability.



HANDRAIL

Lengths Available: 6' thru 16'

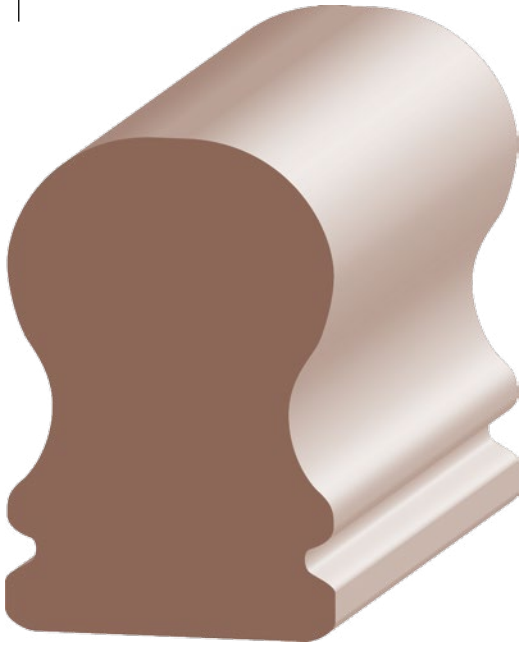

Majestic Handrail 1-3/4 x 2-5/8
933P Poplar



Majestic Handrail
w/ 1/4" x 1-1/4" Plow 1-3/4 x 2-5/8
933PP Poplar

5/8" to 1" PANEL MOLD

Lengths Available: 6' thru 16'

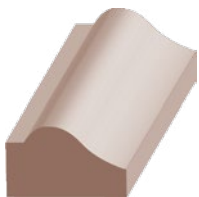

Panel Mold 3/8 x 5/8
600-O Oak

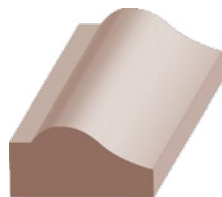

Panel Mold 5/8 x 3/4
601-O Oak

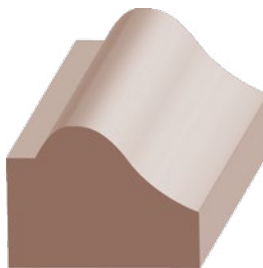

Panel Mold 3/4 x 1
602-O Oak
602ALD Alder

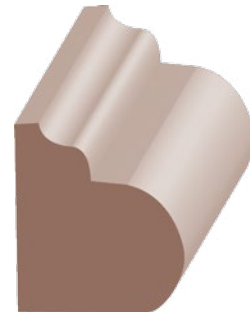

Panel Mold 7/8 x 1
630-O Oak
630P Poplar
630ALD Alder
630C Cherry
630MH Mahogany
630MP Maple

*Hardwood mouldings generally are available in 12' and under. For lengths over 12', please check for availability.

(items are approximate scale only)

1-1/4" to 2" PANEL MOLD

Lengths Available: 6' thru 16'

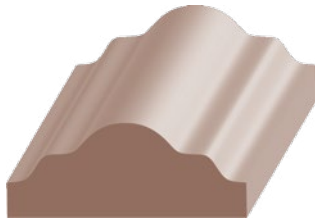

Panel Mold 1/2 x 1-1/4
629P Poplar

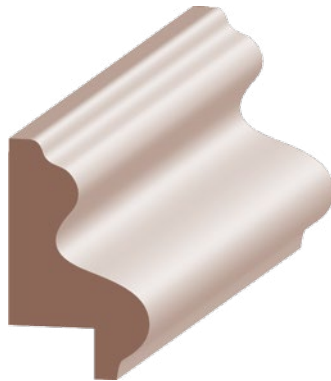

Raised Panel Mold 3/4 x 1-1/4
632-O Oak
632P Poplar
632C Cherry
632MH Mahogany
632MP Maple

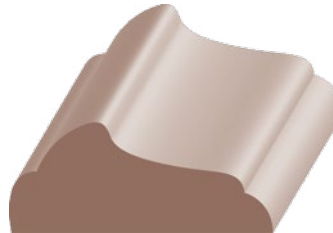

Panel Mold 9/16 x 1-3/8
606-O Oak

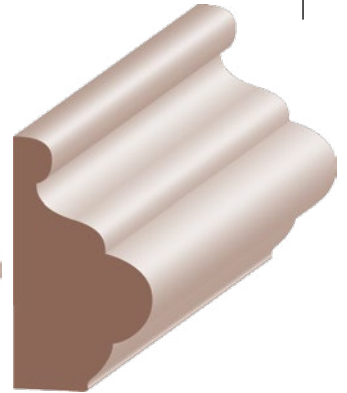

Panel Mold 3/4 x 1-5/16
631-O Oak
631P Poplar
631ALD Alder
631C Cherry
631MH Mahogany
631MP Maple

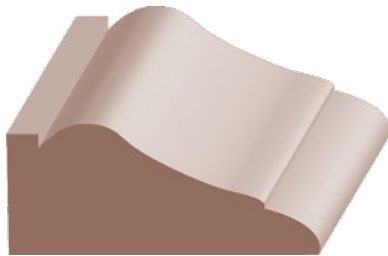

Panel Mold 11/16 x 1-5/8
605-O Oak

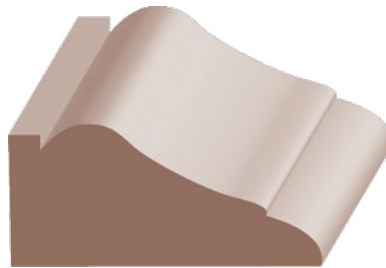

Panel Mold 3/4 x 1-5/8
605ALD Alder

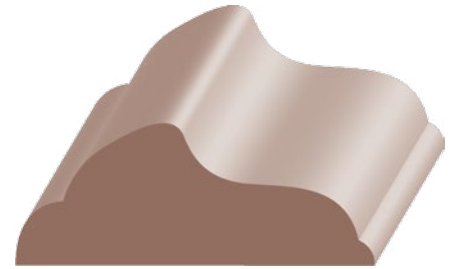

Beauty M-400 Panel Mold 3/4 x 1-7/8
608-O Oak

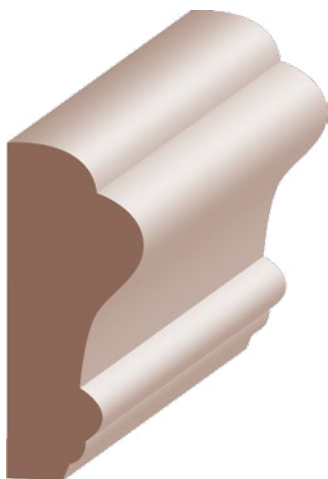

Panel Mold 11/16 x 1-3/4
617P Poplar

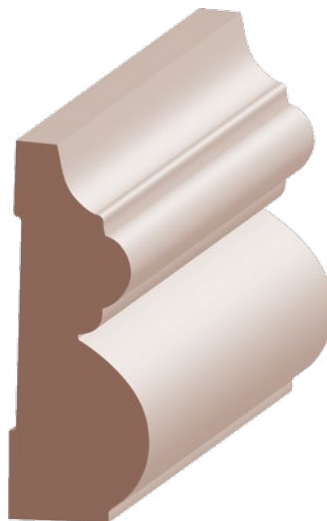

Panel Mold 3/4 x 2
618P Poplar

*Hardwood mouldings generally are available in 12' and under. For lengths over 12', please check for availability.



1-1/4" to 1-5/8" PANEL CAP

Lengths Available: 6' thru 16'

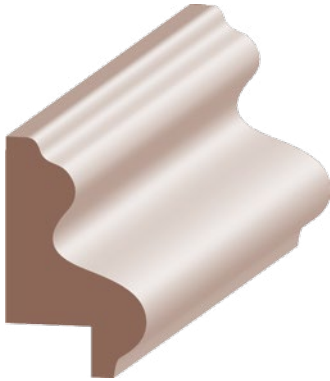

Raised Panel Mold

(w/1/2" Rab't)

3/4 x 1-1/4

632-O	Oak
632P	Poplar
632ALD	Alder
632C	Cherry
632MH	Mahogany
632MP	Maple

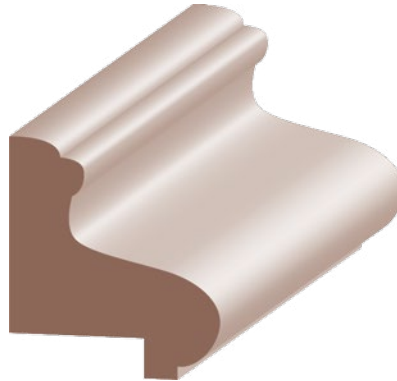

Raised Panel Cap

(w/3/4" Rab't)

1-1/8 x 1-1/4

613-O	Oak
613P	Poplar

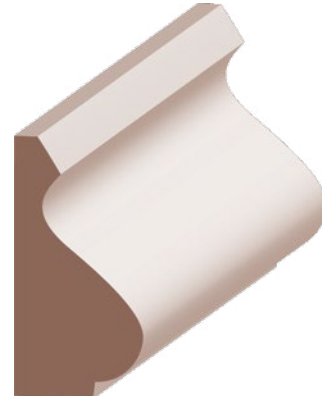

Panel Mold

11/16 x 1-3/8

614-O	Oak
614P	Poplar
614C	Cherry
614MH	Mahogany
614MP	Maple

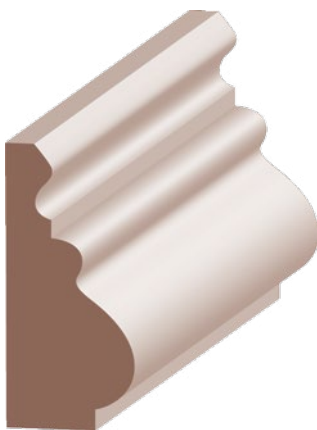

Decorative Base Cap

11/16 x 1-1/2

628-O	Oak
628P	Poplar
628C	Cherry
628MH	Mahogany
628MP	Maple

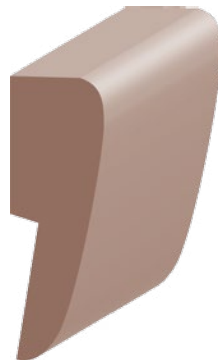

Panel Cap (w/1/2" Rab't)

1 x 1-1/2

730-O	Oak
--------------	-----

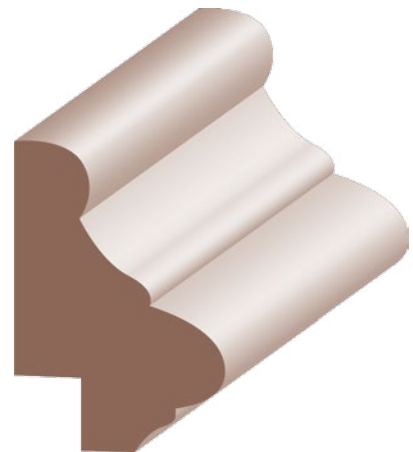

Panel Cap (w/3/8" Rab't)

1-1/8 x 1-5/8

732-O	Oak
--------------	-----

*Hardwood mouldings generally are available in 12' and under. For lengths over 12', please check for availability.

(items are approximate scale only)

1-11/16" to 2-5/16" PANEL CAP

Lengths Available: 6' thru 16'

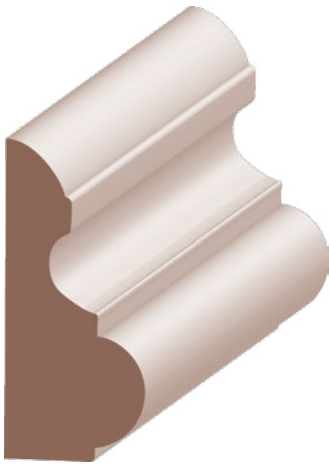

Base Cap 3/4 x 1-11/16
625P Poplar

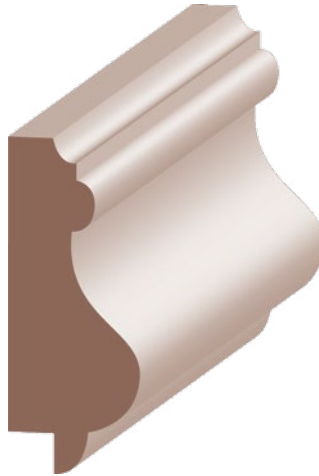

Panel Cap (w/1/4" Rab't) 11/16 x 1-3/4
616P Poplar

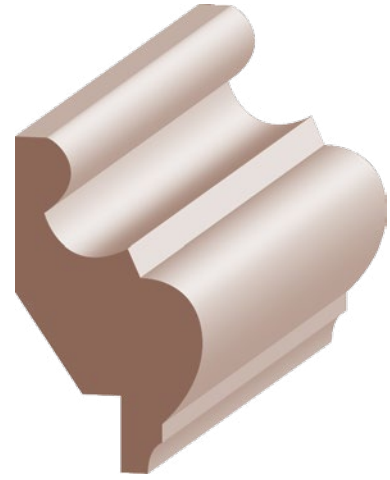

Panel Mold (w/1/2" Rab't) 1 x 1-3/4
620-O Oak
620P Poplar
620ALD Alder
620C Cherry
620MH Mahogany
620MP Maple

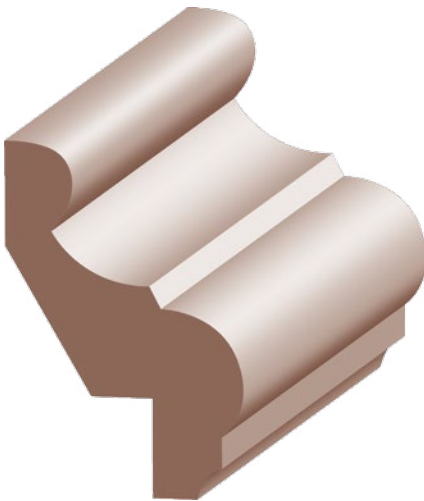

Panel Mold (w/3/4" Rab't) 13/16 x 2
621-O Oak
621P Poplar
621ALD Alder
621C Cherry
621MH Mahogany
621MP Maple

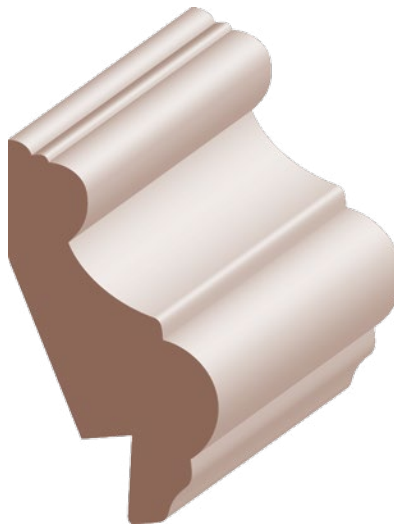

Rab't Panel Cap (w/1/2"-5/8" Rab't) 1-1/8 x 2
615P Poplar

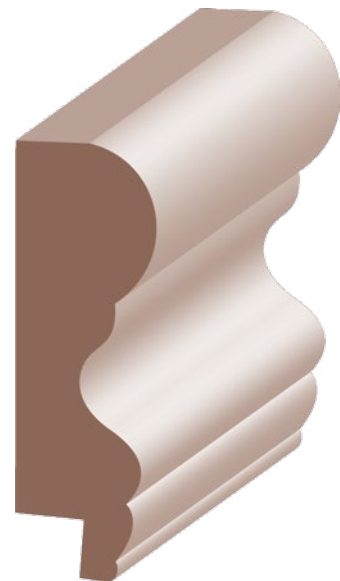

T&G Cap (w/3/8" Rab't) 3/4 x 2-5/16
622ALD Alder

*Hardwood mouldings generally are available in 12' and under. For lengths over 12', please check for availability.



2-5/16" to 2-3/8" PANEL CAP

Lengths Available: 6' thru 16'



Raised Panel Cap

(w/1/8" - 1/4" Rab't)

3/4 x 2-5/16

622P

Poplar

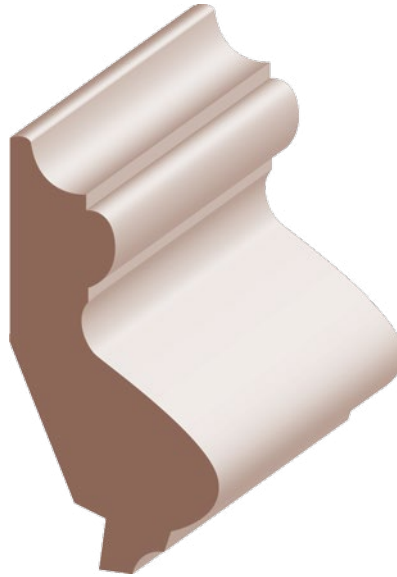

Panel Cap

(w/Rab't for 3/8" & 1/2")

11/16 x 2-3/8

619P

Poplar

ROPE

Lengths Available: 8' only



Half Round – Oak

HR617-0	3/8"
HR618-0	1/2"
HR619-0	3/4"
HR620-0	1"
HR621-0	1-3/16"
HR622-0	1-3/8"
HR623-0	1-1/2"
HR624-0	1-3/4"

Half Round – Alder

HR618ALD	1/2"
HR619ALD	3/4"
HR620ALD	1"
HR621ALD	1-3/16"
HR622ALD	1-3/8"
HR623ALD	1-1/2"
HR624ALD	1-3/4"

Half Round – Poplar

HR617P	3/8"
HR618P	1/2"
HR619P	3/4"
HR620P	1"
HR621P	1-3/16"
HR622P	1-3/8"
HR623P	1-1/2"
HR624P	1-3/4"

Half Round – Maple

HR618MP	1/2"
HR619MP	3/4"
HR620MP	1"
HR621MP	1-3/16"
HR622MP	1-3/8"
HR623MP	1-1/2"
HR624MP	1-3/4"

Half Round – Cherry

HR617C	3/8"
HR618C	1/2"
HR619C	3/4"
HR620C	1"
HR621C	1-3/16"
HR622C	1-3/8"
HR623C	1-1/2"
HR624C	1-3/4"

Full Round – Oak

FR626-0	1-3/8"
FR627-0	1-3/4"

Full Round – Poplar

FR626P	1-3/8"
FR627P	1-3/4"

Full Round – Cherry

FR626C	1-3/8"
FR627C	1-3/4"

*Hardwood mouldings generally are available in 12' and under. For lengths over 12', please check for availability.

(items are approximate scale only)

T&G WAINSCOT & WAINSCOT BASE

Lengths Available: 6' thru 16'



Beaded T&G Wainscot $3/8 \times 3-3/8$
2000P Poplar

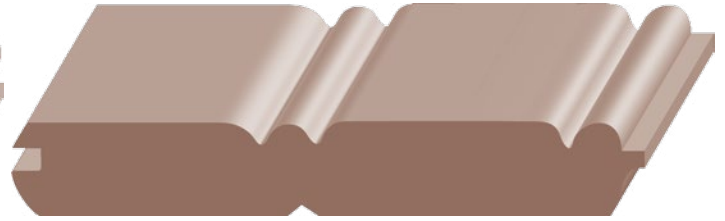

Reversible Beaded T&G Wainscot $3/8 \times 3-3/8$
2000-OR Oak (Reversible)
2000PR Poplar (Reversible)
2000ALDR Alder (Reversible)

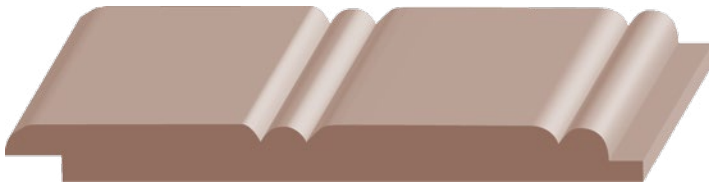

Shiplap T&G Wainscot $5/16 \times 3-3/8$
2003ALD Alder

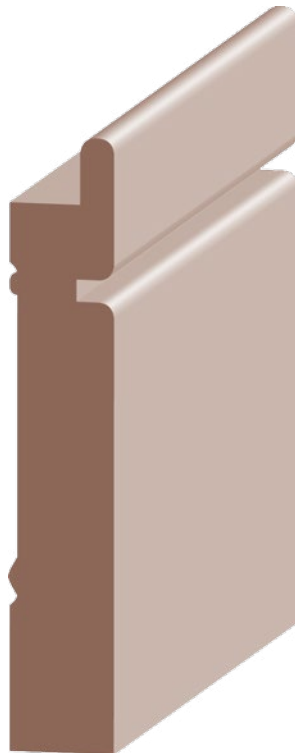

T&G Wainscot Base $9/16 \times 3-1/4$
735P Poplar



T&G Wainscot Base $9/16 \times 5$
736ALD Alder

*Hardwood mouldings generally are available in 12' and under. For lengths over 12', please check for availability.



SCREEN MOLD

Lengths Available: 6' thru 16'

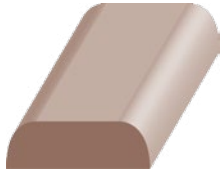

Flat Screen Mold $1/4 \times 3/4$
591-O Oak

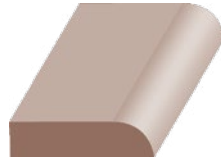

Scribe Mold $3/16 \times 3/4$
593-O Oak
593P Poplar
593ALD Alder
593C Cherry
593MH Mahogany
593MP Maple

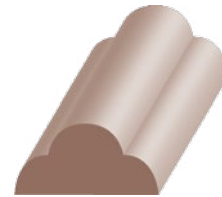

Cloverleaf $3/8 \times 3/4$
594-O Oak
594P Poplar
594ALD Alder
594C Cherry
594MH Mahogany
594MP Maple

QUARTER / HALF / FULL ROUND

Lengths Available: 6' thru 16'

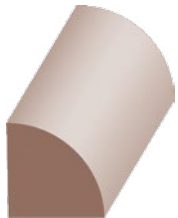

Quarter Round $1/2 \times 1/2$
502-O Oak
502P Poplar
502C Cherry
502MH Mahogany
502MP Maple

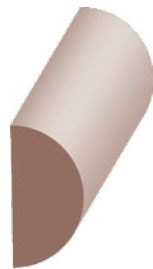

Half Round $3/8 \times 3/4$
572-O Oak
572P Poplar
572C Cherry
572MH Mahogany
572MP Maple

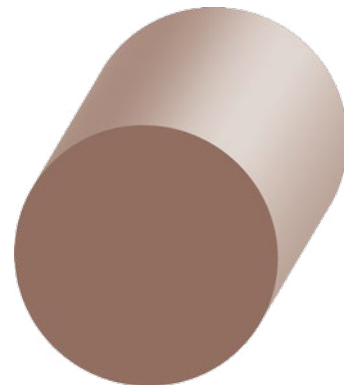

Full Round $1-3/8 \times 1-3/8$
803-O Oak

$3/4 \times 3/4$
504-O Oak
504P Poplar
504ALD Alder
504C Cherry
504MH Mahogany
504MP Maple

$3/4 \times 1-1/2$
575P Poplar
 1×2
576P Poplar

*Hardwood mouldings generally are available in 12' and under. For lengths over 12', please check for availability.

(items are approximate scale only)

ASTRAGAL

Lengths Available: 7', 8', & 10'

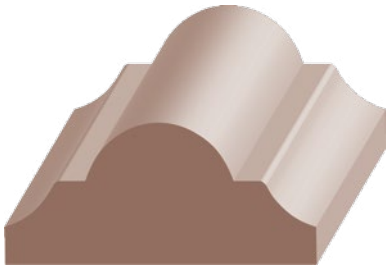

Flat Astragal

[Lengths Available: 7' thru 16']

3/4 x 1-5/8

660-O	Oak
660P	Poplar
660ALD	Alder
660VG	VG Fir
660C	Cherry
660MH	Mahogany
660MP	Maple

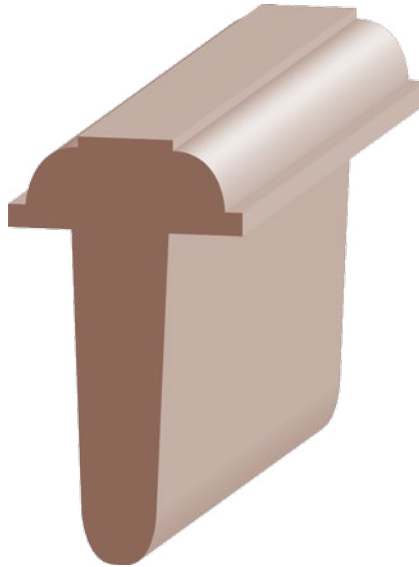

T-Astragal for 1-3/4" Doors

1-1/4 x 2-1/4

661ALD	Alder
661MH	Mahogany
<hr/>	
661-O	Oak

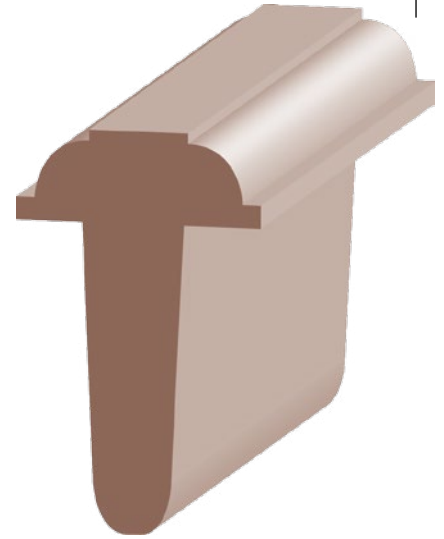

T-Astragal for 1-3/8" Doors

1-1/4 x 2

662-O	Oak
--------------	-----

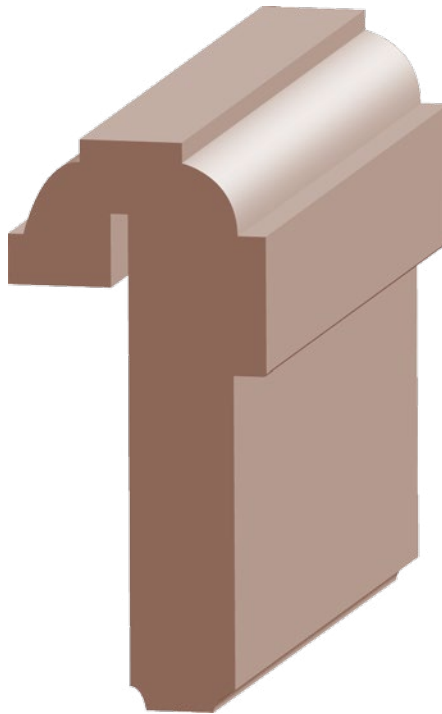

T-Astragal w/ Weatherstrip Kerf for 1-3/4" Doors

(Q-Lon® weatherstrip not included)

1-3/8 x 3

663-O	Oak
663ALD	Alder
663MH	Mahogany

Q-Lon® for T-Astragal

TQ7B	81" Brown
TQ7W	81" White
TQ8B	97" Brown
TQ8W	97" White



NOSE & COVE

Lengths Available: 6' thru 16'

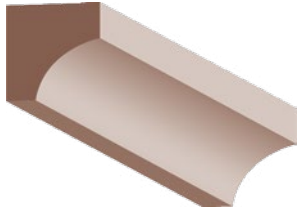

Cove	1/2 x 1/2
521-O	Oak
521P	Poplar
521ALD	Alder
521C	Cherry
521MH	Mahogany
521MP	Maple

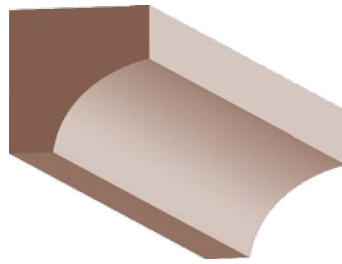

Cove	3/4 x 3/4
523-O	Oak
523P	Poplar
523ALD	Alder
523C	Cherry
523MH	Mahogany
523MP	Maple

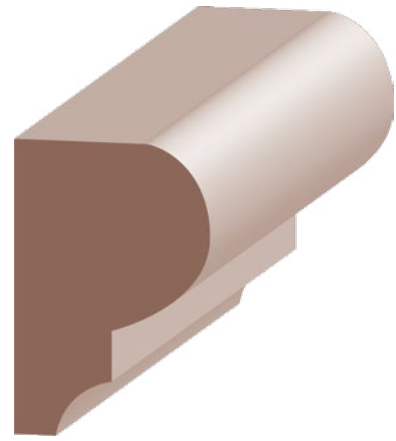

Nose & Cove	1 x 1-5/8
909-O	Oak
909P	Poplar
909ALD	Alder

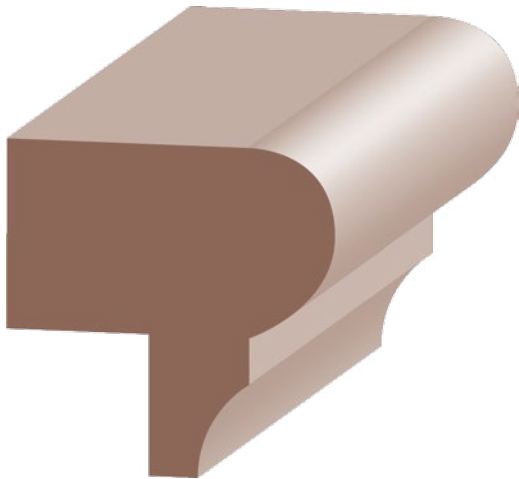

Rab't Nose & Cove (w/3/4" Rab't)	1-3/4 x 1-3/4
910-O	Oak
910P	Poplar

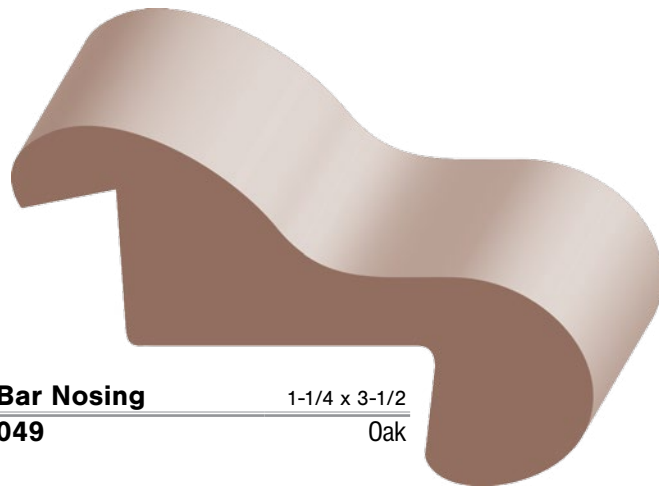

Bar Nosing	1-1/4 x 3-1/2
049	Oak

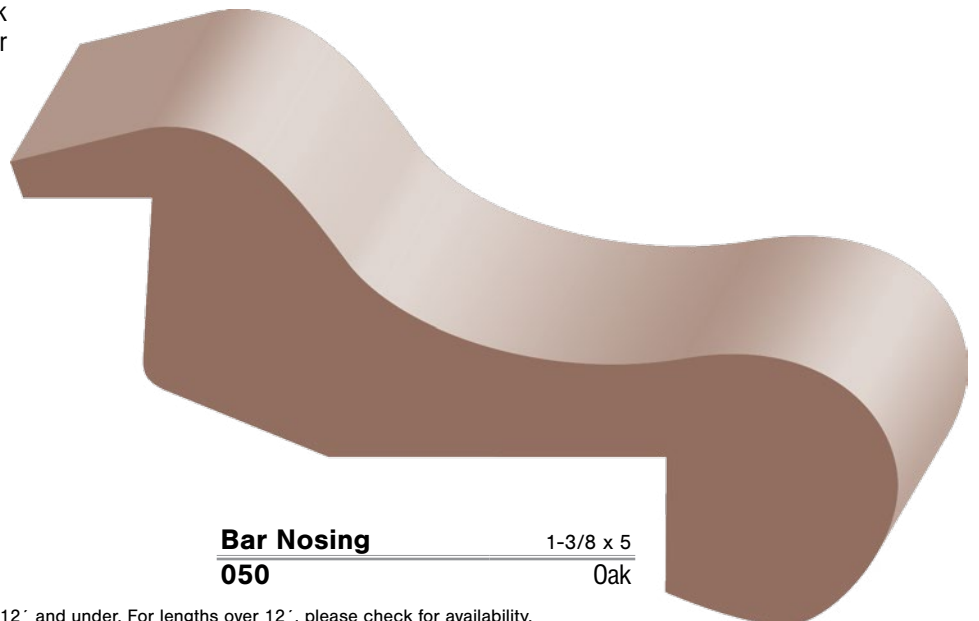

Bar Nosing	1-3/8 x 5
050	Oak

*Hardwood moulding is generally available in 12' and under. For lengths over 12', please check for availability.

(items are approximate scale only)

STOOL & LINTEL

Lengths Available: 6' thru 16'

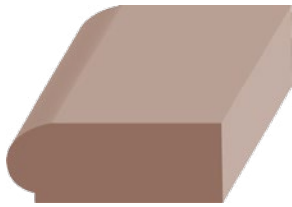

Stool 7/16 x 1-1/8
995P Poplar

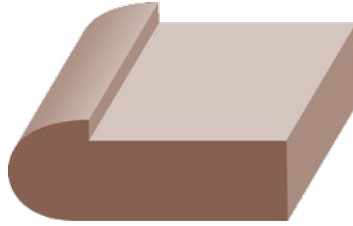

Rab't Stool 1/2 x 1-7/16
(w/ 1/8" x 1" Rab't) Poplar
996P

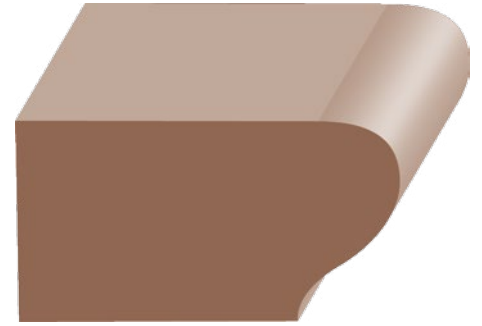

Stool 1-1/16 x 2
997P Poplar

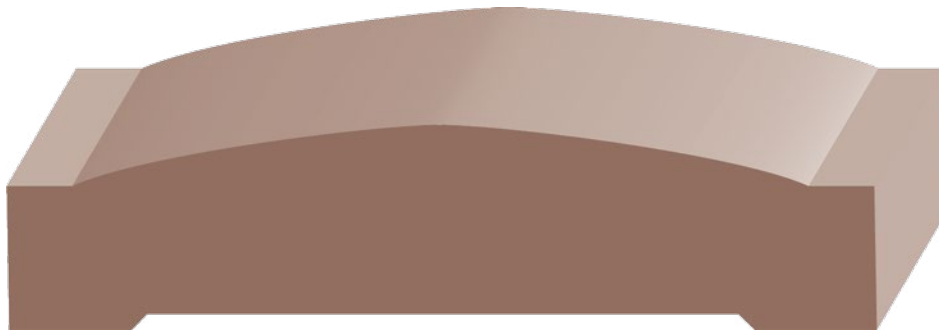

Lintel 1-1/16 x 4-1/2
998P Poplar

OUTSIDE CORNER GUARD

Lengths Available: 6' thru 16'

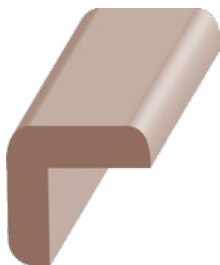

Outside Corner 3/4 x 3/4
720-O Oak

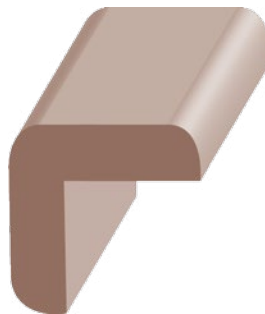

Outside Corner 1 x 1
721-0 Oak
721P Poplar
721ALD Alder
721C Cherry
721MH Mahogany
721MP Maple

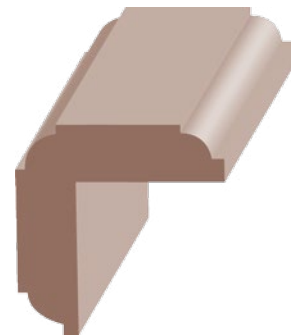

Detail Outside Corner 1-1/8 x 1-1/8
723-0 Oak
723P Poplar
723C Cherry
723MH Mahogany
723MP Maple

*Hardwood mouldings generally are available in 12' and under. For lengths over 12', please check for availability.



EXTERIOR MOLD

Lengths Available: 6' thru 16'

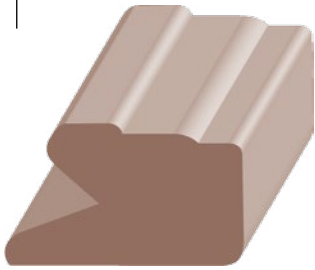

Large Stucco Mold	<u>7/8 x 1-1/4</u>
826-O	Oak
826ALD	Alder

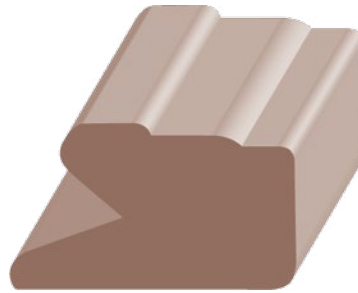

Large Stucco Mold	<u>7/8 x 1-1/2</u>
826MH	Mahogany

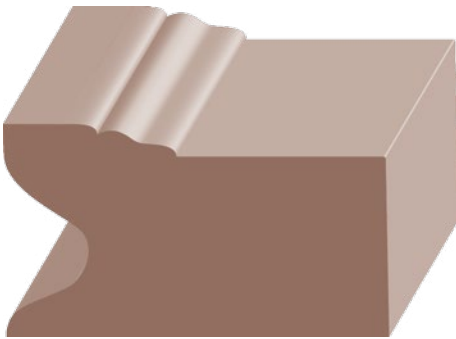

180 Eastern Brick Mold w/ Stucco Key	<u>1-1/8 x 2</u>
612B-O	Oak
612BALD	Alder
612BMH	Mahogany

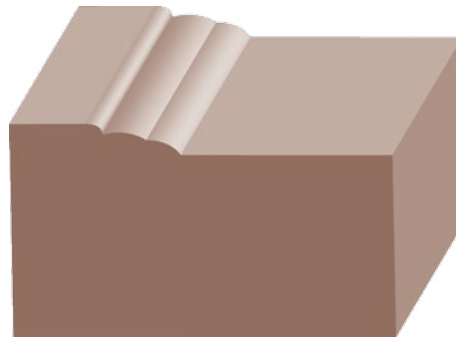

180 Eastern Brick Mold	<u>1-1/8 x 2</u>
612A-O	Oak
612ALD	Alder
612AMH	Mahogany

T-MOLD & REDUCER

Lengths Available: 6' thru 16'

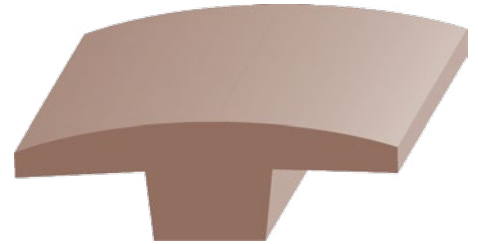

T-Mold	<u>5/8 x 2</u>
992-O	Oak
992C	Cherry
992MP	Maple



Reducer	<u>1/2 x 2</u>
994-O	Oak
994C	Cherry
994MP	Maple



Variable Reducer	<u>11/16 x 2</u>
993-O	Oak
993C	Cherry
993MP	Maple

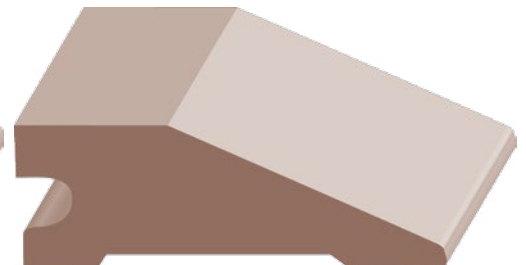

Reducer	<u>3/4 x 2-1/4</u>
999-O	Oak
999C	Cherry
999MP	Maple

*Hardwood mouldings generally are available in 12' and under. For lengths over 12', please check for availability.

(items are approximate scale only)

EXTERIOR SILL

Lengths Available: 6' thru 16'



Beveled Oak Sill

8OS	1-1/4 x 7-1/8
10OS	1-1/4 x 8-7/8
12OS	1-1/4 x 11-1/4

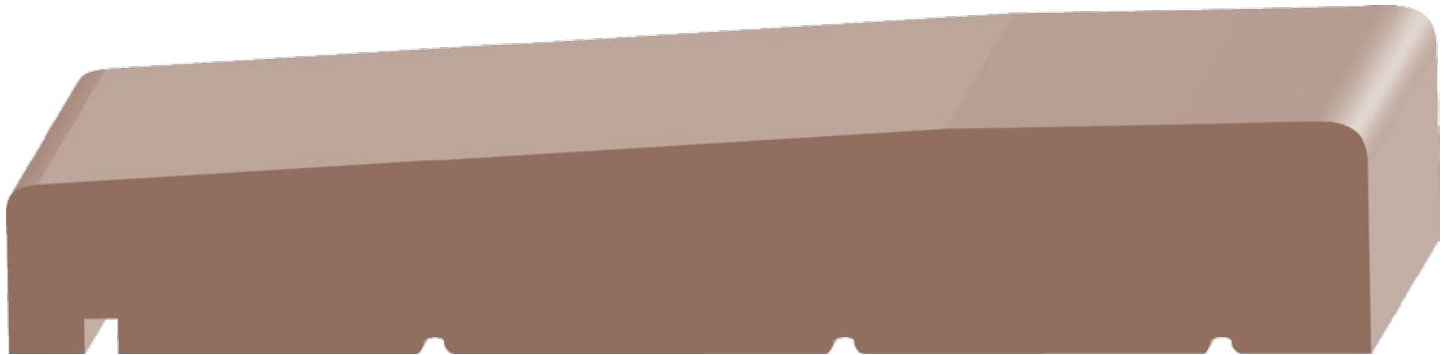

Flat Oak Sill

8FOS	1-1/4 x 7-1/8
10FOS	1-1/4 x 8-7/8
12FOS	1-1/4 x 11-1/4

S4S

Lengths Available: 6' thru 16'

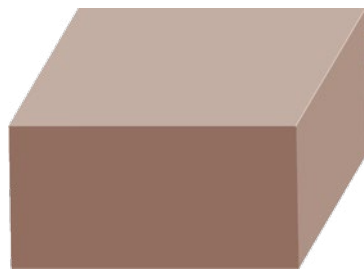

Interior S4S Boards

Oak	Cherry	Alder
713-O	715C	715ALD
3/4 x 1-5/8	3/4 x 3-1/2	3/4 x 3-1/2
715-O	750C	750ALD
3/4 x 3-1/2	3/4 x 5-1/2	3/4 x 5-1/2
750-O	751C	751ALD
3/4 x 5-1/2	3/4 x 7-1/4	3/4 x 7-1/4
751-O	752C	
3/4 x 7-1/4	3/4 x 9-1/4	
753-O	Maple	
3/4 x 11-1/4	715MP	
Poplar	3/4 x 3-1/2	
713P	750MP	
3/4 x 1-1/2	3/4 x 5-1/2	
715P	751MP	
3/4 x 3-1/2	3/4 x 7-1/4	
750P	Mahogany	
3/4 x 5-1/2	715MH	
751P	3/4 x 3-1/2	
3/4 x 7-1/4	750MH	
752P	3/4 x 5-1/2	
3/4 x 9-1/4	751MH	
753P	3/4 x 11-1/4	
3/4 x 11-1/4		



THRESHOLD



Oak Threshold

850 5/8 x 3-1/2
850A 5/8 x 3-1/2 x 37"



Oak Threshold

851 3/4 x 3-1/2
851A 3/4 x 3-1/2 x 37"



Oak Threshold

854 1 x 3-1/2
854A 1 x 3-1/2 x 37"



Oak Threshold

853 3/4 x 4-1/2
853A 3/4 x 4-1/2 x 37"



Oak Threshold

852 1 x 5-1/2
852A 1 x 5-1/2 x 37"

*Hardwood mouldings generally are available in 12' and under. For lengths over 12', please check for availability.

DOOR JAMBS & FRAMES



Interior Door Jamb

Kerfing for bullnose is available on all jamb sizes and species. Custom size odd wall widths available upon request.

SIZE	SPECIES	6/8	8/0	RANDOM LINEAL
3-9/16	Superior Alder	3916ALDI6	3916ALDI8	3916ALDIL
4-9/16	Oak	4916OI6	4916OI8	4916OIL
	Oak Laminate	4916OLI6	-	-
	Poplar	4916PI6	4916PI8	4916PIL
4-5/8	Superior Alder	458ALDI6	458ALDI8	458ALDIL
4-3/4	Oak	434OI6	434OI8	434OIL
	Oak Lam	434OLI6	-	-
	Poplar	434PI6	434PI8	434PIL
	Mahogany	-	434MHI8	-
4-7/8	Superior Alder	478ALDI6	478ALDI8	478ALDIL
5-1/4	Oak	514OI6	514OI8	514OIL
	Oak Lam	514OLI6	-	-
	Poplar	514PI6	514PI8	514PIL
	Superior Alder	514ALDI6	514ALDI8	514ALDIL
	Mahogany	-	514MHI8	-
7-1/4	Solid Pine	714SPI6	714SPI8	-
	Oak	714OI6	714OI8	714OIL
	Poplar	714PI6	714PI8	714PIL
	Superior Alder	714ALDI6	714ALDI8	714ALDIL
	Mahogany	-	714MHI8	-
11-1/4	Oak	1114OI6	1114OI8	1114OIL
	Poplar	1114PI6	1114PI8	1114PIL

Specifications:

11/16" Thick
6/8 = 81" Below Dado
8/0 = 97" Below Dado

- Lineal = 17'
- Dado depth = 3/8"
- Heads cut 3/4 over opening
- 5 pair per bundle

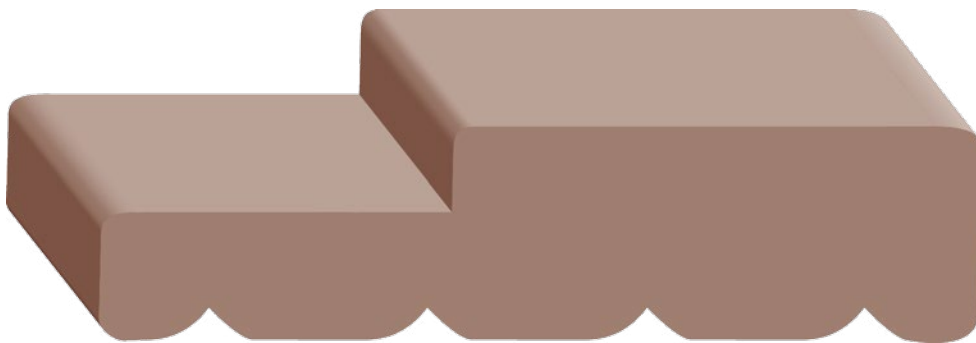

Standard Exterior Door Frame for 1-3/4" Doors

No kerf | With 1/2" x 1-13/16" Door Rab't

Specifications:

1-3/4" doors only
6/8 = 82-1/2" Below Dado
8/0 = 98-1/2" Below Dado

- No screen rab't
- Single end dado (except on lineal)
- 3 pairs per bundle
- Kerfing for Bullnose is available
- Custom widths available

SIZE	SPECIES	6/8	8/0	RANDOM LINEAL
4-1/8	Oak	418O6	418O8	418OL
	Poplar	418P6	418P8	418PL
	Mahogany	418M6	418M8	418ML
4-1/2	Oak	412O6	412O8	412OL
4-5/8	Knotty Alder	-	458KA8	-
5-1/4	Oak	514OE6	514OE8	514OEL
	Poplar	514PE6	514PE8	514PEL
	Knotty Alder	-	514KA8	-
	Mahogany	514ME6	514ME8	514MEL
6-1/8	Poplar	618P6	-	-
7-1/4	Oak	714OE6	714OE8	714OEL
	Poplar	714PE6	714PE8	714PEL
	Knotty Alder	-	714KA8	-
	Mahogany	714ME6	714ME8	714MEL



DOOR JAMBS & FRAMES

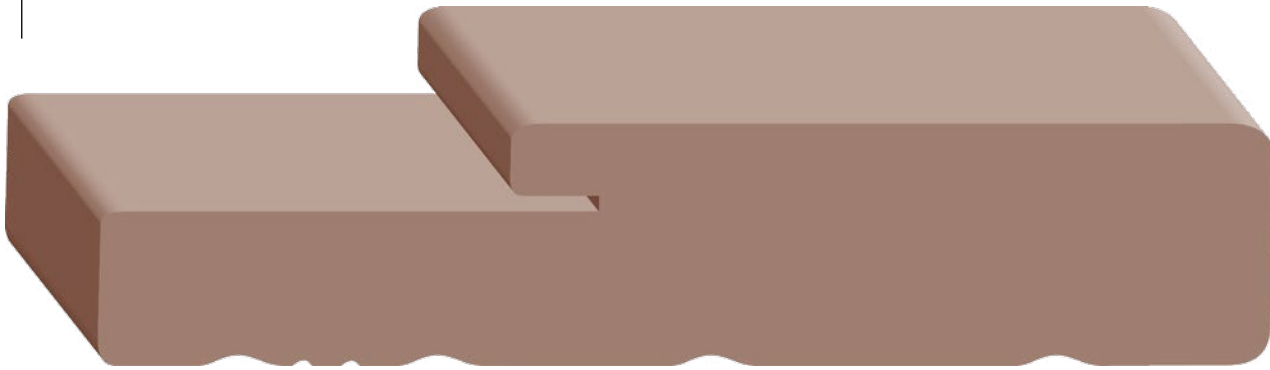

Kerfed Exterior Door Frame for 1-3/4" Doors

for 1/2" x 2-1/8" Door Rab't

Specifications:

1-3/4" doors only
Jamb Thickness = 1-1/4"
6/8 = 82-1/2" Below Dado
8/0 = 98-1/2" Below Dado

- No screen rab't
- Single end dado (except on lineal)
- 3 pairs per bundle
- Kerfing for Bullnose is available
- Custom widths available

SIZE	SPECIES	6/8	8/0	RANDOM LINEAL
4-1/8	Oak	418WO6	418WO8	418WOL
	Poplar	418WP6	418WP8	418WPL
	Mahogany	418WM6	418WM8	418WML
4-5/8	Oak	458WO6	458WO8	458WOL
	Knotty Alder	-	458WKA8	-
4-3/4	Poplar	434WP6	434WP8	-
5-1/4	Oak	514WO6	514WO8	514WOL
	Poplar	514WP6	514WP8	514WPL
	Knotty Alder	-	514WKA8	-
	Mahogany	514WM6	514WM8	514WML
6-1/8	Poplar	618WP6	618WP8	-
7-1/4	Oak	714WO6	714WO8	714WOL
	Poplar	714WP6	714WP8	714WPL
	Knotty Alder	-	714WKA8	-
	Mahogany	714WM6	714WM8	714WML

Ultralight **MDF** & Light Density **LDF**

FOR PAINTGRADE AND ARCHITECTURAL MILLWORK



Inside

Astragal.....	170
Base	129-147
Base Cap.....	158
Build-Ups.....	175
Casing.....	119-128
Chair Rail.....	167
Cleat	170
Crown & Cornice.....	148-166
Door Stop.....	128
Flat Astragal.....	159
Header Skirt.....	129
Hook.....	170
Interior Door Jambs	174
Panel Cap.....	168
Panel Mold	168
S4S (interior).....	171
Shelving.....	172-173
T&G Wainscot.....	169
Wainscot Cap	158
Wall Cap	171
Window Stool.....	171



Ultralight **MDF** & Light Density **LDF**

FOR PAINTGRADE AND ARCHITECTURAL MILLWORK



Ultralight MDF and Light Density LDF are paint grade products that provide wonderful architectural profiles at amazingly affordable prices.

Our Ultralight MDF, identified as MUL, is an ultra lightweight density fiberboard imported from Chile, and are produced using sustainable forestry management. MUL is not harvested from natural forests, nor does its fiber come from genetically modified or old-growth trees. The wood fibers, combined with resin, produce a product weighing similar to pine. While typical MDF moulding is much heavier in weight, and when installed can pucker around nails, our Ultralight MDF moulding nails more like pine moulding. The combination of lighter weight and better nailing makes EL & EL Ultralight MDF an ideal choice for both high-end and budget jobs.

With costs less than finger joint pine, MUL and Light Density LDF are pre-primed, have no joints, will not crack, split, twist or warp and never have raised or inconsistent grain. Produced domestically, LDF has helped in replacing finger joint pine as the only reasonably priced paint grade product of choice. MUL and Light Density LDF are the moulding of choice for multi-million dollar homes, as well as entry to high-end tract housing. They are ideal for any home or office to improve on typical moulding without adding increased costs.

LONG LENGTHS STANDARD

ALL STYLES IN STOCK

PREPRIMED

NO DEFECTS

(items are approximate scale only)



1-5/8" to 2-1/4" CASING

Lengths Available: 7' & 17'



Flat Streamline Casing 5/8 x 1-5/8
102LDF

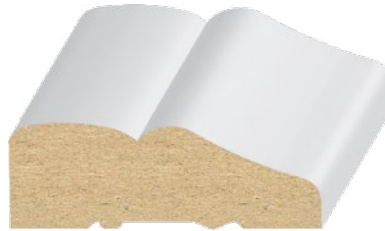

#711 Casing 1/2 x 1-5/8
107MUL



Moulded Casing 5/8 x 1-5/8
130MUL



Clamshell Casing 9/16 x 2
121MUL **NEW**

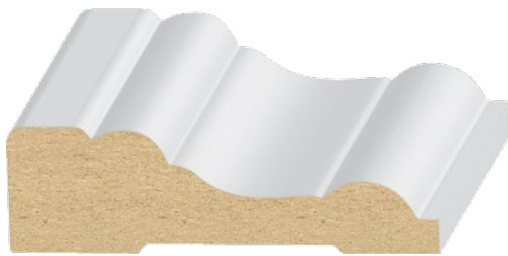

Tucson Casing 11/16 x 2-1/4
104MUL **NEW**



Clamshell Casing 9/16 x 2-1/4
105MUL



Peoria Casing 9/16 x 2-1/4
106MUL **NEW**

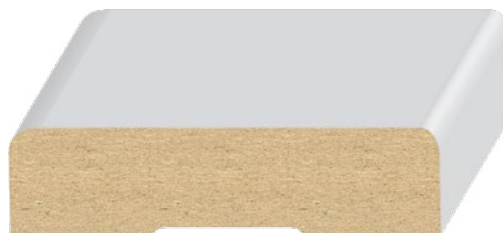

2 Round Edge Casing 5/8 x 2-1/4
120MUL

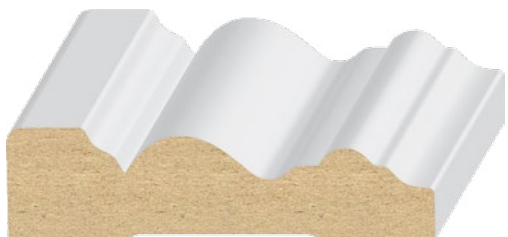

Colorado Casing 9/16 x 2-1/4
123MUL **NEW**



#356 Casing 5/8 x 2-1/4
152MUL



2-1/4" to 2-1/2" CASING

Lengths Available: 7' & 17'

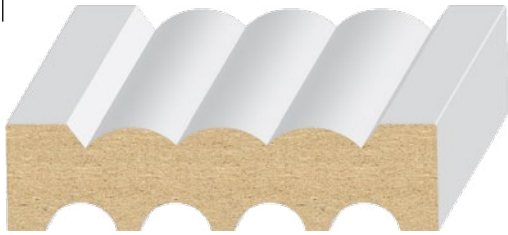

4-Flute & Reed Casing (Reversible) 9/16 x 2-1/4
158MUL-2

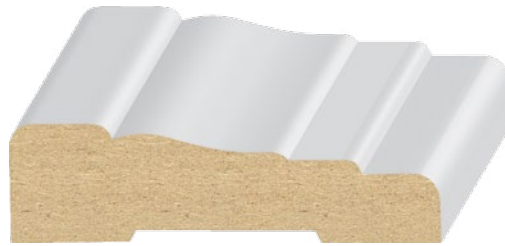

#366 Casing 5/8 x 2-1/4
162MUL **NEW**

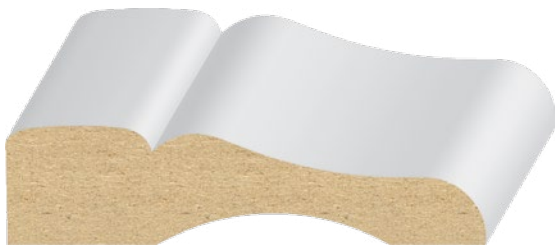

#711 Casing 5/8 x 2-1/2
108MUL

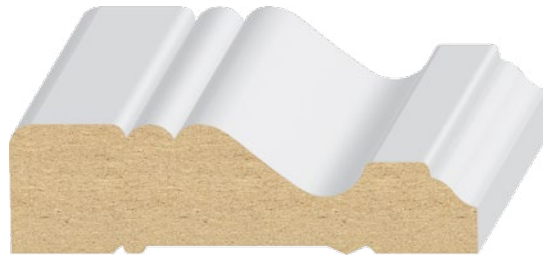

Palisade Casing 11/16 x 2-7/16
132MUL



#275 Casing 11/16 x 2-7/16
167MUL



Howe Casing 11/16 x 2-7/16
178MUL



3-Step Casing 5/8 x 2-1/2
110MUL



Bel-Air Casing 11/16 x 2-1/2
128MUL

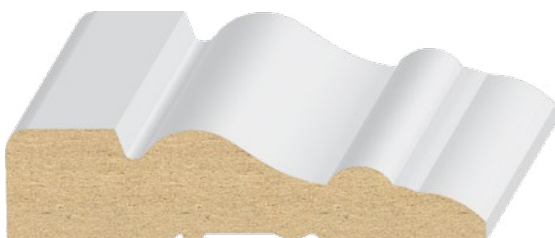

Bayport Casing 5/8 x 2-1/2
134MUL



Carmel Casing 5/8 x 2-1/2
137MUL

(items are approximate scale only)

2-1/2" to 2-3/4" CASING

Lengths Available: 7' & 17'

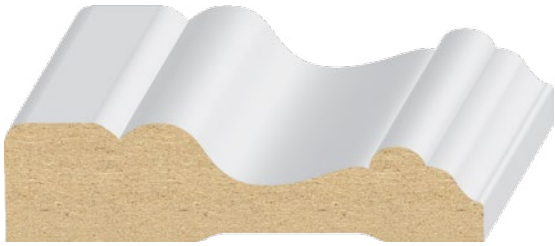

Cape Cod Casing $5/8 \times 2-1/2$
150MUL

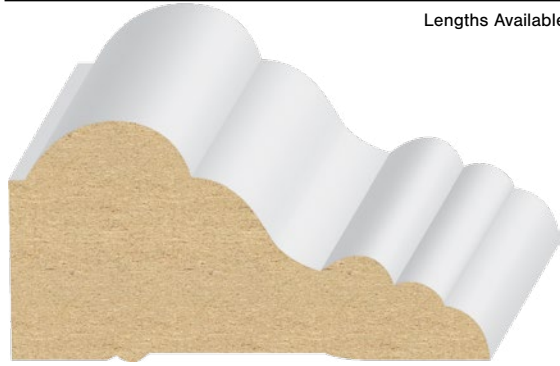

Coronado Casing $1-1/4 \times 2-1/2$
157MUL

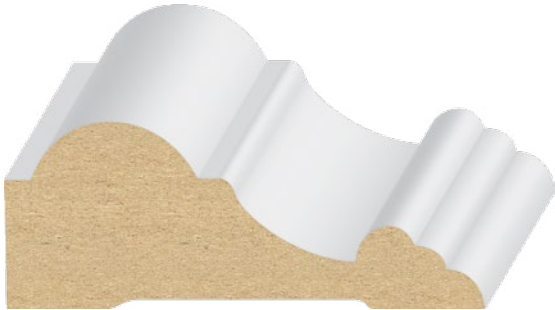

Hermosa Casing $1 \times 2-1/2$
159MUL



Bell Court Casing $1-1/4 \times 2-1/2$
164MUL

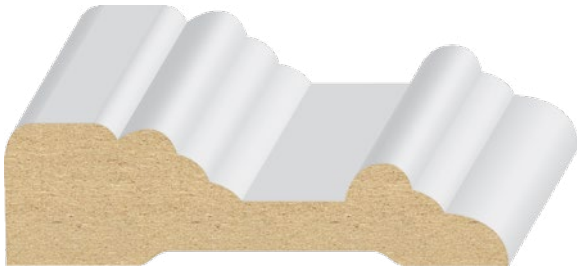

Crescent Casing $3/4 \times 2-5/8$
168MUL

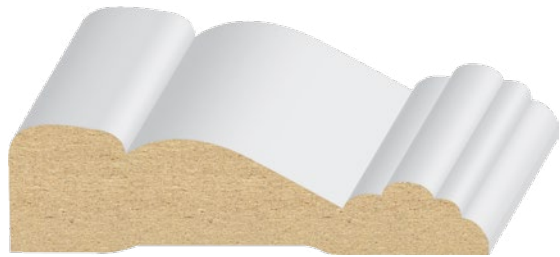

Tudor Casing $11/16 \times 2-1/2$
169MUL



Malibu Casing $1 \times 2-9/16$
181MUL

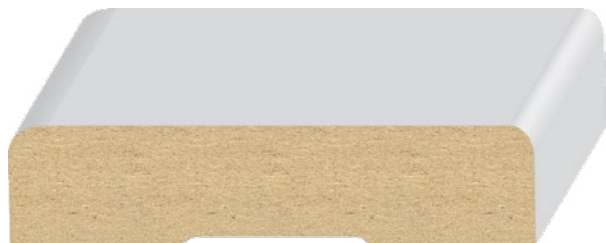

2 Round Edge Casing $3/4 \times 2-3/4$
122MUL



2-7/8" to 3-3/16" CASING

Lengths Available: 7' & 17'

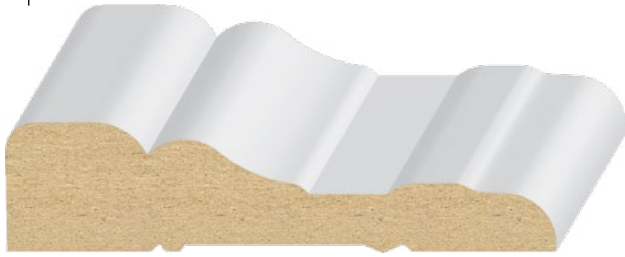

Colonial Casing 11/16 x 2-7/8
119MUL

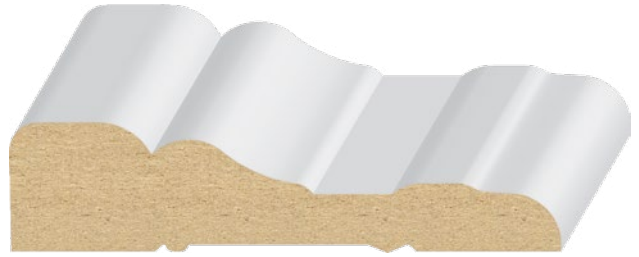

Colonial Casing 11/16 x 2-7/8
119MUL

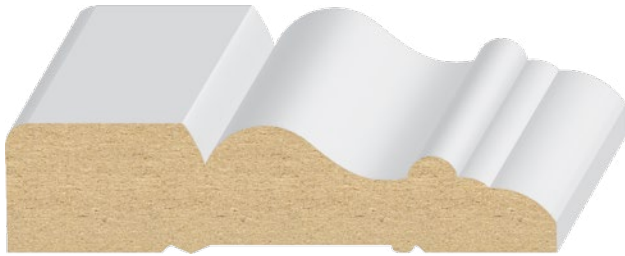

Newport Casing 11/16 x 2-7/8
125MUL

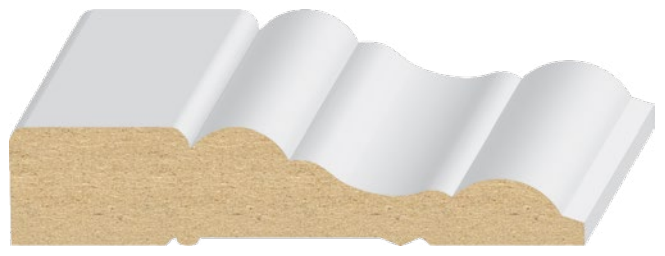

New Hampshire Casing 5/8 x 3
127MUL

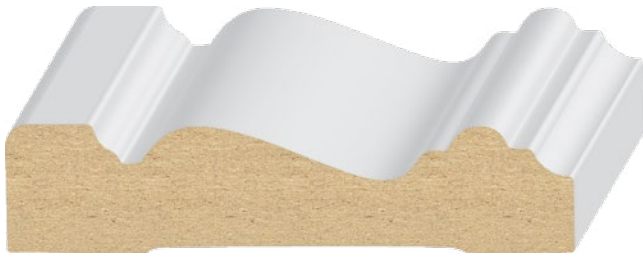

Colorado Casing 11/16 x 3
124MUL **NEW**



#275 Casing 11/16 x 3
165MUL



Intrada Casing 11/16 x 3
192MUL **NEW**



Hermosa Casing 1-3/16 x 3-3/16
160MUL

(items are approximate scale only)



3-1/4" CASING

Lengths Available: 7' & 17'

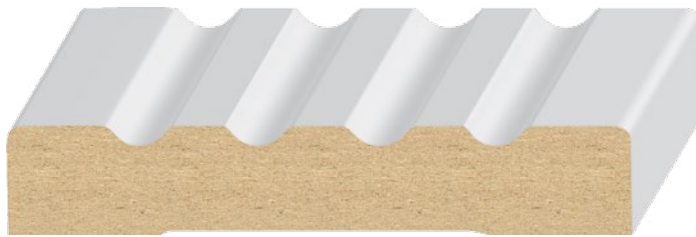

4-Flute Casing

(not reversible)

9/16 x 3-1/4

109MUL

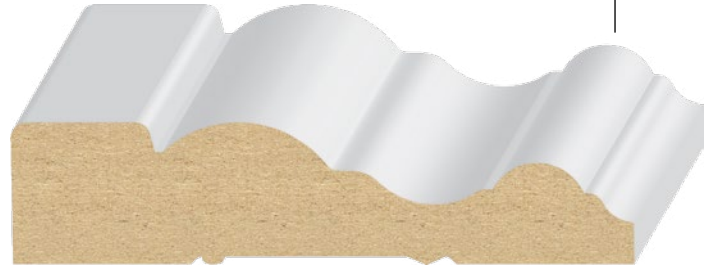

Bel-Air Casing

3/4 x 3-1/4

129MUL

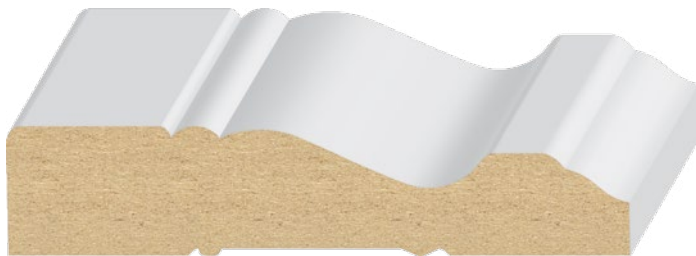

Palisade Casing

11/16 x 3-1/4

133MUL

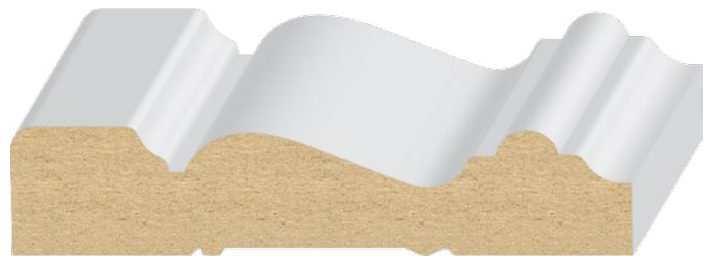

Monterey Casing

11/16 x 3-1/4

135MUL



2 Round Edge Casing

9/16 x 3-1/4

139MUL-SC

NEW

9/16 x 3-1/4



2 Round Edge Casing

11/16 x 3-1/4

139MUL

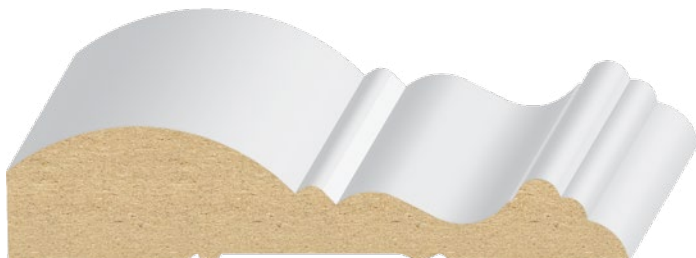

Cambridge Casing

11/16 x 3-1/4

161MUL

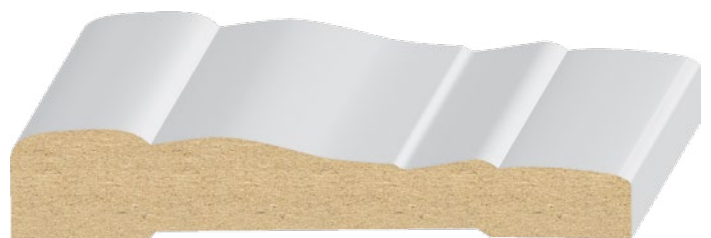

#366 Casing

5/8 x 3-1/4

163MUL

NEW



3-1/4" CASING

Lengths Available: 7' & 17'

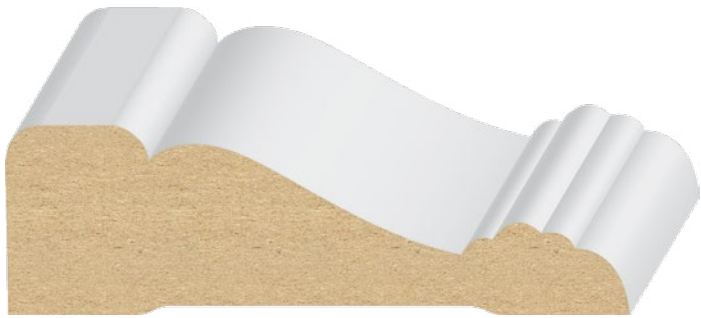

Tudor Casing 1 x 3-1/4
170MUL



#365 / Moulded Casing (Scant) 9 /16 x 3-1/4
176MUL-SC **NEW**

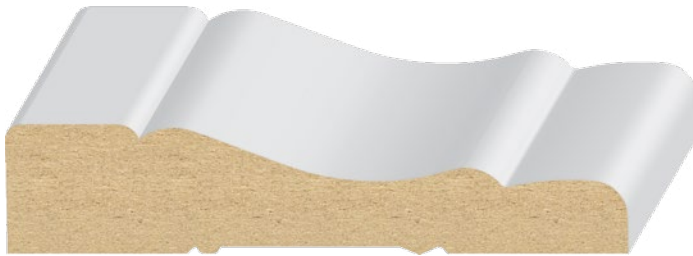

#365 / Moulded Casing 11/16 x 3-1/4
176MUL

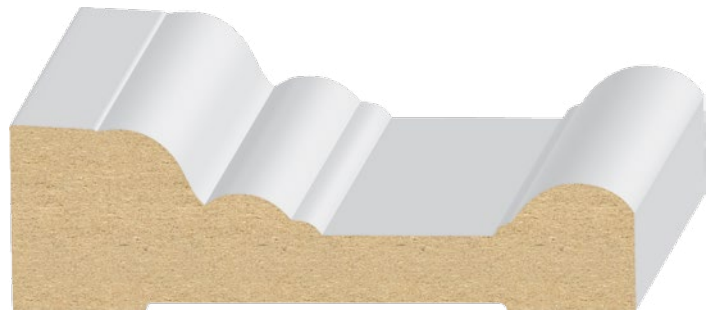

Chandler Casing 15/16 x 3-1/4
191MUL **NEW**

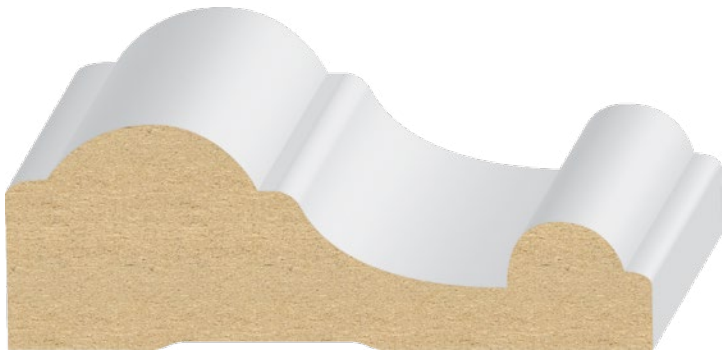

Malibu Casing 1-3/16 x 3-3/8
180MUL



Crescent Casing (Scant) 11/16 x 3-1/2
126MUL-SC

(items are approximate scale only)



3-1/2" CASING

Lengths Available: 7' & 17'

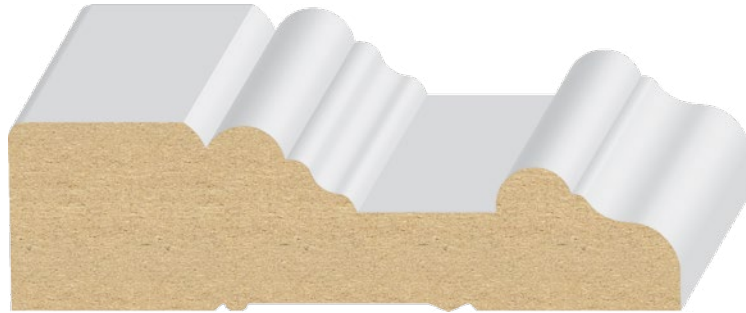

Crescent Casing 1 x 3-1/2
126MUL



#275 Casing 1 x 3-1/2
166MUL



Savannah Casing 1-3/16 x 3-1/2
147MUL



Cape Cod Casing 11/16 x 3-1/2
155MUL



3-1/2" to 4" CASING

Lengths Available: 7' & 17'

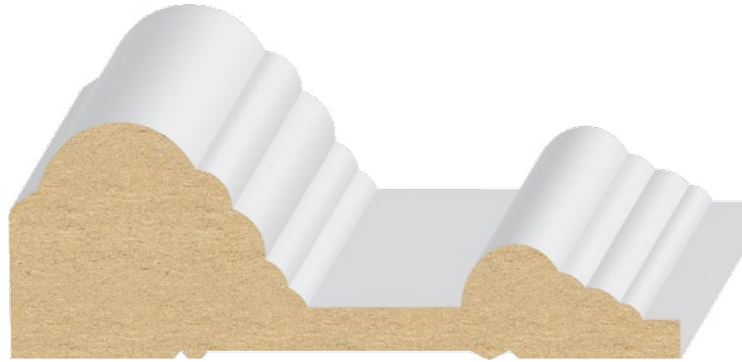

Crescent Casing 1-1/4 x 3-1/2
173MUL

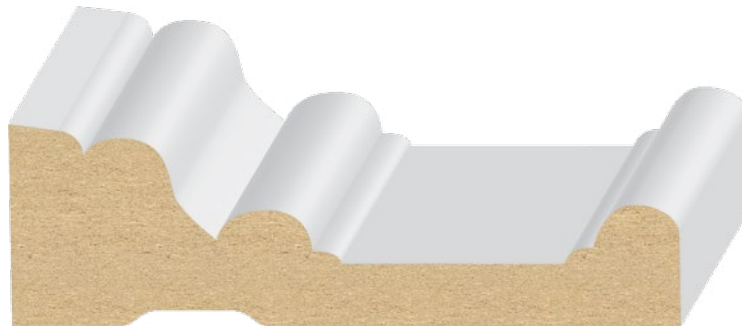

Howe Casing 1-1/16 x 3-1/2
177MUL

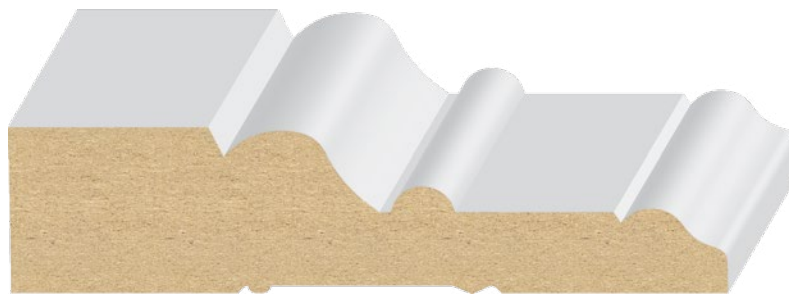

Tuscany Casing 7/8 x 3-3/4
175MUL



Bullhead Casing 11/16 x 4
193MUL **NEW**



4-1/4" CASING

Lengths Available: 7' & 17'

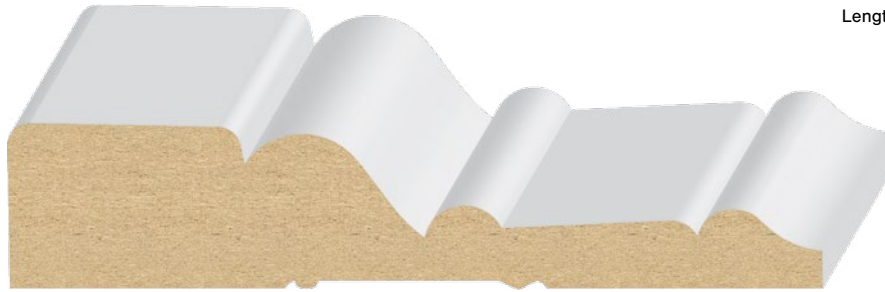

Tuscan Casing 7/8 x 4-1/4
140MUL

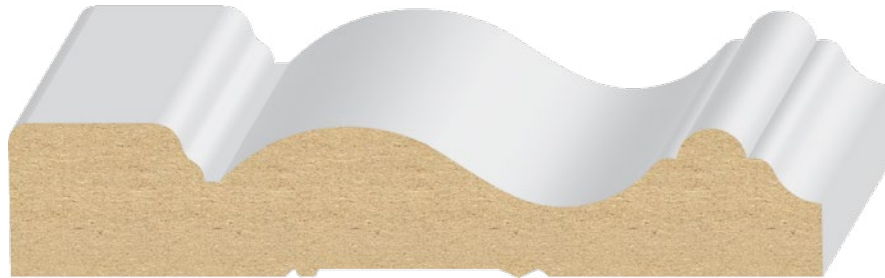

Monterey Casing 13/16 x 4-1/4
136MUL

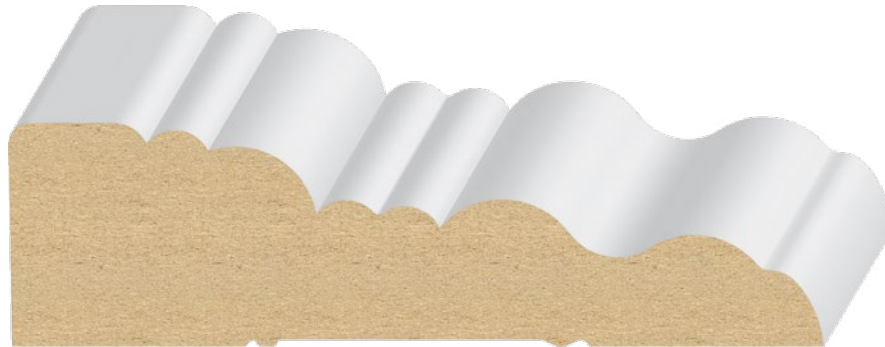

Williamsburg Casing 1-3/16 x 4-1/4
143MUL



Malibu Casing 1-3/4 x 4-1/4
148MUL



4-1/4" to 5-1/2" CASING

Lengths Available: 7' & 17'

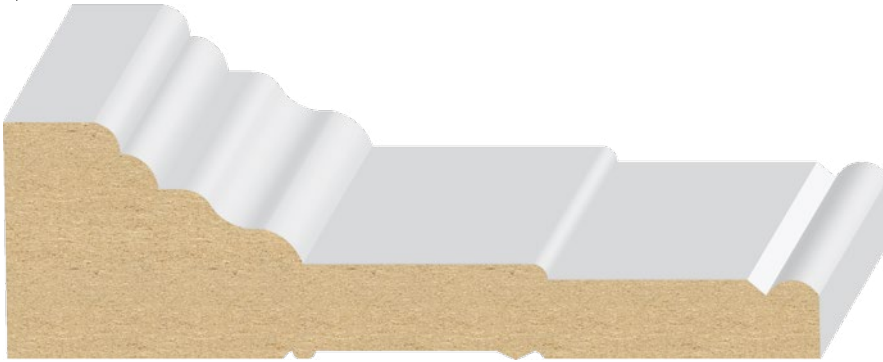

Carolina Casing 1-1/4 x 4-1/4
185MUL



2 Round Edge Casing 3/4 x 4-1/2
145MUL

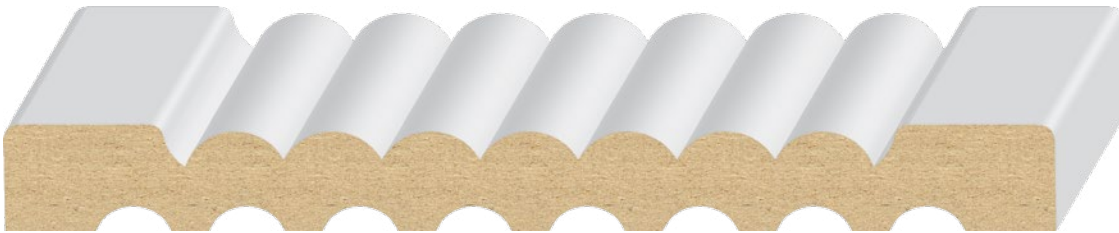

8 Flute & Reed Casing (Reversible) 9/16 x 5-1/2
171MUL

STOP

Lengths Available: 7', 8' & 16'



2 Round Edge Stop 3/8 x 1-1/4
202MUL



2 Round Edge Stop 1/2 x 1-3/8
203MUL



Ogee Stop 1/2 x 1-3/4
210MUL

(items are approximate scale only)

HEADER & HEADER SKIRT

Lengths Available: 7' & 17'



2 Eased Edge Header Skirt
970LDF 11/16 x 1-1/4



1 Round Edge Header
144MUL 1 x 5-1/2

2-1/4" to 2-1/2" BASE

Lengths Available: 16'



Streamline Base
304MUL 3/8 x 2-1/4



Reversible Base
M304LDF 3/8 x 2-1/4



#711 Base
310MUL 3/8 x 2-1/2
310LDF 7/16 x 2-1/2



#356 Base
319LDF 1/2 x 2-1/2



3" to 3-1/2" BASE

Lengths Available: 16'



#711 Base 1/2 x 3
311LDF-3 **NEW**



#623 Base
314MUL-3SC 1/2 x 3-1/4
314MUL-3 9/16 x 3-1/4
314LDF 9/16 x 3-1/4



#356 Base 1/2 x 3-1/4
320MUL



Sonoma Base 9/16 x 3-1/4
361MUL-3 **NEW**



Sierra Base 9/16 x 3-1/4
351MUL



#366 Base 9/16 x 3-1/4
366LDF



Crescent Base 9/16 x 3-1/2
339MUL



#711 Base
311MUL 3/8 x 3-1/2
311LDF 7/16 x 3-1/2

(items are approximate scale only)



3-1/2" BASE

Lengths Available: 16'



Monterey Base $7/16 \times 3-1/2$
335MUL



3-Step Base $1/2 \times 3-1/2$
322MUL



1 Round Edge Base $1/2 \times 3-1/2$
388MUL-3



Colonial Base $9/16 \times 3-1/2$
118MUL-3



3-1/2" to 3-7/8" BASE

Lengths Available: 16'



Bullnose Base 9/16 x 3-1/2
307MUL



#175 Base 9/16 x 3-1/2
325MUL-3



Hermosa Base 9/16 x 3-3/4
324MUL



Cape Cod Base 7/16 x 3-7/8
313MUL

(items are approximate scale only)

3-7/8" to 4-3/16" BASE

Lengths Available: 16'



Newport Base $9/16 \times 3-7/8$
329MUL
329LDF



Cape Cod Base $9/16 \times 4$
318MUL



3-Step Base $1/2 \times 4-1/8$
321MUL



#711 Base $7/16 \times 4-3/16$
311LDF-4



4 -1/4" to 4-1/2" BASE

Lengths Available: 16'

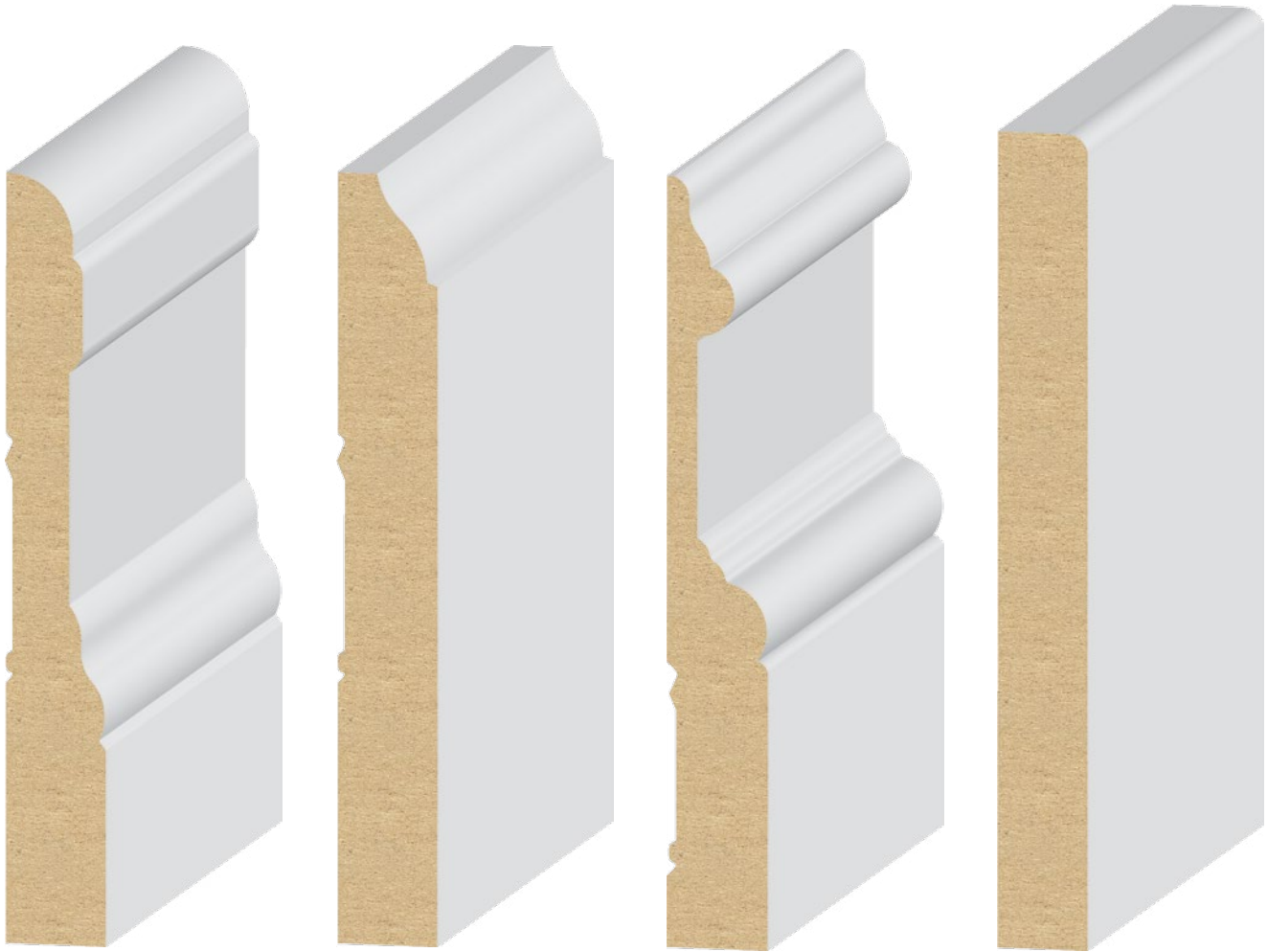

Colonial Base
118MUL-4 9/16 x 4-1/4

#620 Base
314MUL-4 9/16 x 4-1/4

Crescent Base
326MUL 9/16 x 4-1/4

1 Round Edge Base
388MUL-4 1/2 x 4-1/2

(items are approximate scale only)



4-1/2" BASE

Lengths Available: 16'



#175 Base 9/16 x 4-1/2
325MUL-4



**New
Hampshire
Base** 9/16 x 4-1/2
327MUL-4 **NEW**



#175 Base 9/16 x 4-1/2
338MUL-4



**Sonoma
Base** 9/16 x 4-1/2
361MUL-4 **NEW**



4-1/2" to 5" CASING

Lengths Available: 16'



#412 Base 9/16 x 4-1/2
370MUL



Hermosa Base 9/16 x 5
323MUL



Newport Base 9/16 x 5
330MUL

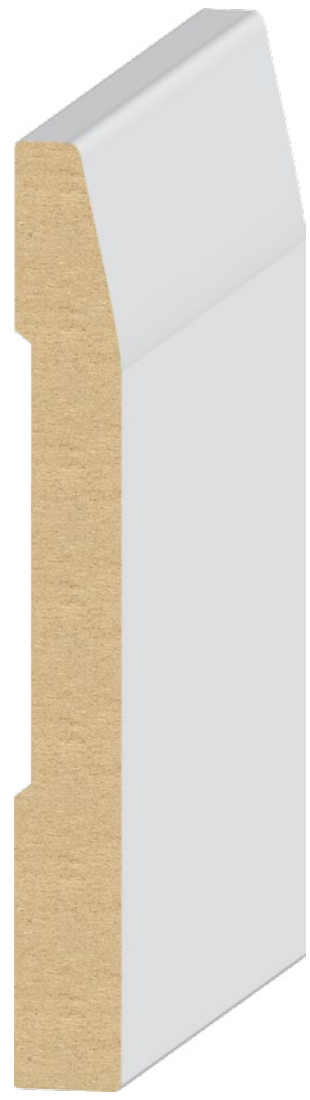

Intrada Base 9/16 x 5
390MUL **NEW**

(items are approximate scale only)



5-1/4" BASE

Lengths Available: 16'



Colonial Base 9/16 x 5-1/4
118MUL-5



#618 Base 9/16 x 5-1/4
315MUL



Crescent Base 9/16 x 5-1/4
317MUL



"B" Cape Cod Base 9/16 x 5-1/4
318BMUL



5-1/4" BASE

Lengths Available: 16'



Cape Cod Base 9/16 x 5-1/4
318MUL-5



New Hampshire Base 9/16 x 5-1/4
327MUL-5 **NEW**



Colonial Base 9/16 x 5-1/4
328MUL



#175 Base 9/16 x 5-1/4
338MUL

(items are approximate scale only)



5-1/4" BASE

Lengths Available: 16'



Monterey Base 9/16 x 5-1/4
341MUL



Harris Base 9/16 x 5-1/4
355MUL **NEW**



Sonoma Base 9/16 x 5-1/4
361MUL-5 **NEW**



#566 Base 9/16 x 5-1/4
368MUL



5-1/4" BASE

Lengths Available: 16'



Classic Base
9/16 x 5-1/4
377MUL



Lancaster Base
5/8 x 5-1/4
365MUL



1 Round Edge Base
1/2 x 5-1/2
388MUL-5



Bullnose Base
9/16 x 5-1/4
354MUL

(items are approximate scale only)

5-3/4" to 6" BASE

Lengths Available: 16'



Crescent Base
332MUL
9/16 x 5-3/4



#175 Base
342MUL
9/16 x 6



Palisade Base
385MUL
5/8 x 6



Tuscany Base
375MUL
11/16 x 6



6-1/8" to 7-1/4" BASE

Lengths Available: 16'

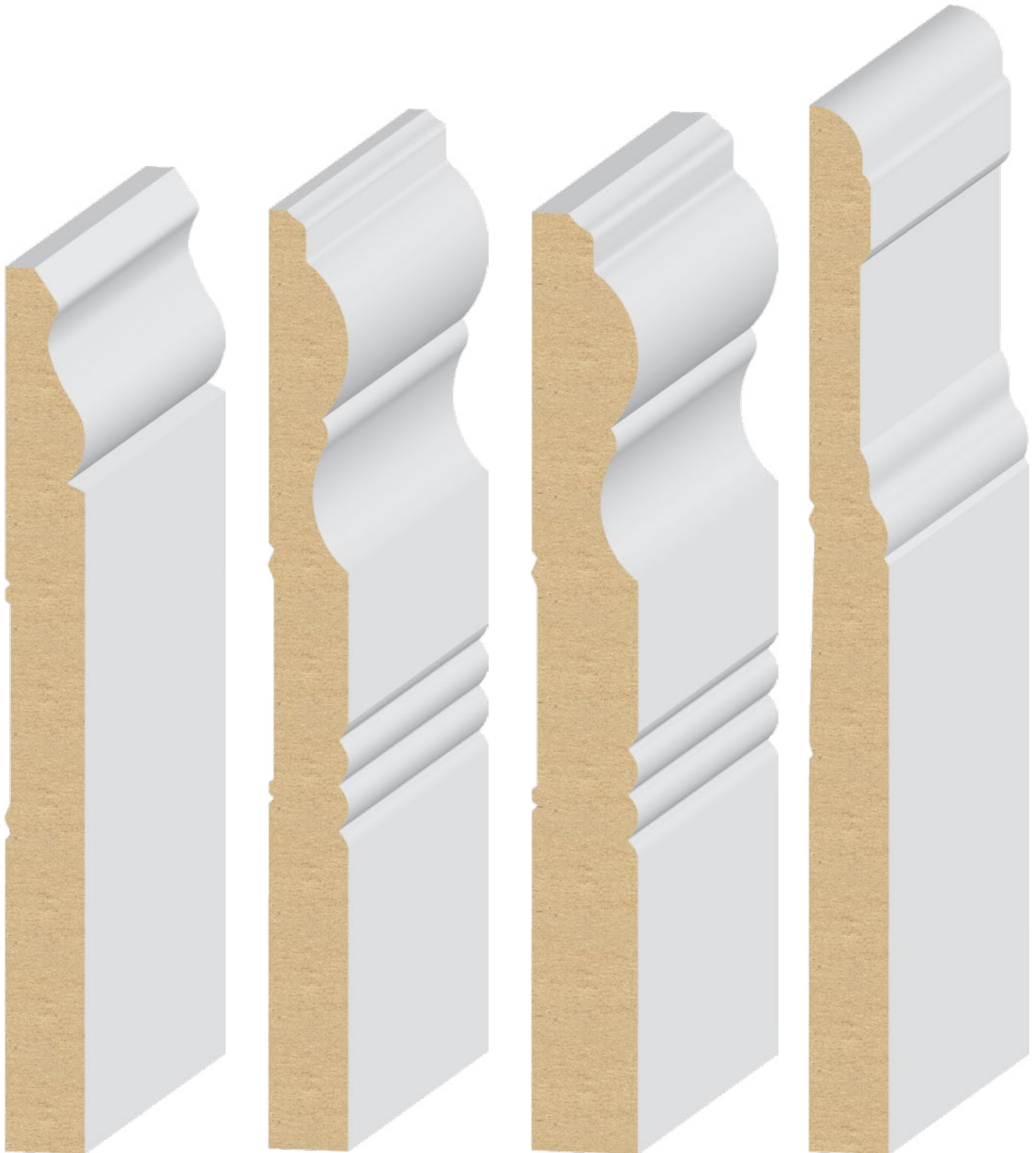

Colonial Base
9/16 x 6-1/8
328MUL-6

Vermont Base
(Thin Version)
9/16 x 6-1/2
334BMUL

Vermont Base
3/4 x 6-1/2
334MUL

Colonial Base
9/16 x 7-1/4
118MUL-7

(items are approximate scale only)



7-1/4" BASE

Lengths Available: 16'



#613 Base 9/16 x 7-1/4
314MUL-7



Mission Bay Base 9/16 x 7-1/4
333MUL



Hermosa Base 9/16 x 7-1/4
340MUL



#175 Base 9/16 x 7-1/4
342MUL-7



7-1/4" BASE

Lengths Available: 16'



Laguna Base 9/16 x 7-1/4
343MUL



Crescent Base 9/16 x 7-1/4
345MUL



Bullnose Base 9/16 x 7-1/4
358MUL



Sonoma Base 9/16 x 7-1/4
386MUL

(items are approximate scale only)



7-1/4" to 8" BASE

Lengths Available: 16'



Classic Base 3/4 x 7-1/4
376MUL



Savannah Base 1 x 7-3/8
379MUL



Newport Base 9/16 x 8
331MUL



8-1/4" to 9-1/4" BASE

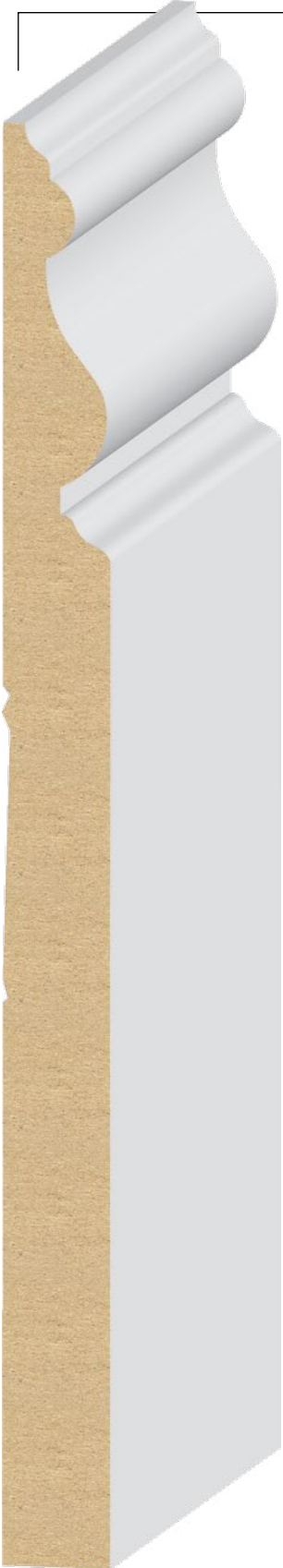

#175 Base 5/8 x 8-1/4
357MUL



Savannah Base 1 x 8-1/2
380MUL



Camden Base 1 x 8-1/2
381MUL

(items are approximate scale only)



Williamsburg Base 1 x 8-1/2
382MUL



Sonoma Base 9/16 x 9-1/4
383MUL



#175 Base 9/16 x 9-1/4
384MUL



1-1/2" to 2-5/8" CROWN & CORNICE

Lengths Available: 16'

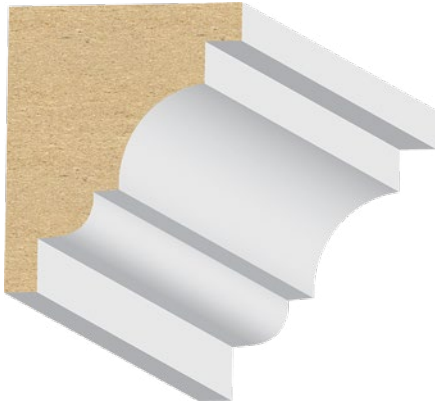

Pediment Crown 1-1/4 x 1-1/2
438MUL



Bed Mold 9/16 x 1-7/8
420MUL



Corner Mold 1 x 1-7/8
419MUL

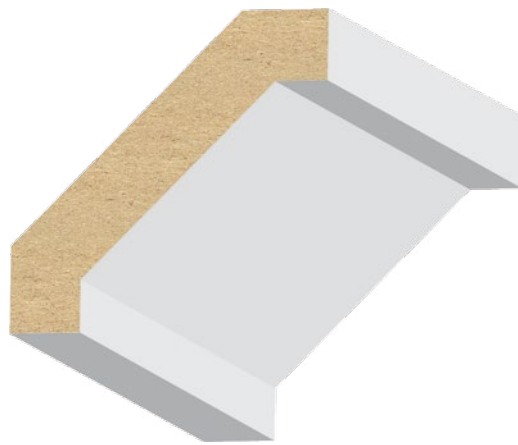

Craftsman Crown 9/16 x 2-3/8
460MUL-2



Bed Mold 9/16 x 2-1/2
402MUL



Colonial Crown 9/16 x 2-5/8
401MUL

(items are approximate scale only)

2-3/4" to 3-3/8" CROWN & CORNICE

Lengths Available: 16'



Classic Pediment $1\text{-}3/8 \times 2\text{-}3/4$
440MUL



Pediment Crown $1\text{-}1/4 \times 3$
439MUL



Colonial Crown $9/16 \times 3\text{-}1/4$
405MUL



Carolina Crown $3/4 \times 3\text{-}3/8$
421MUL



3-7/16" to 4-3/16" CROWN & CORNICE

Lengths Available: 16'



Georgian Crown 9/16 x 3-7/16
426MUL



Cornice 1-1/4 x 3-3/4
411MUL

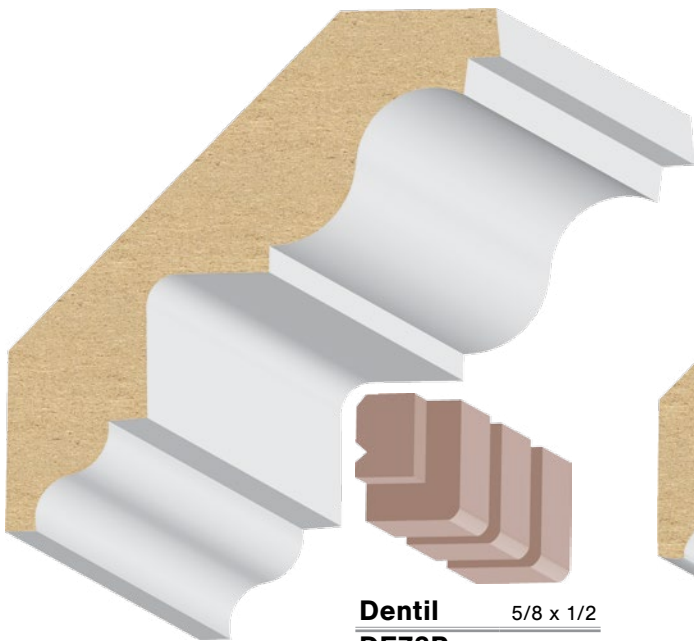

Dentil Ready Crown 3/4 x 3-3/4
425MUL-3

Dentil 5/8 x 1/2
DE73P

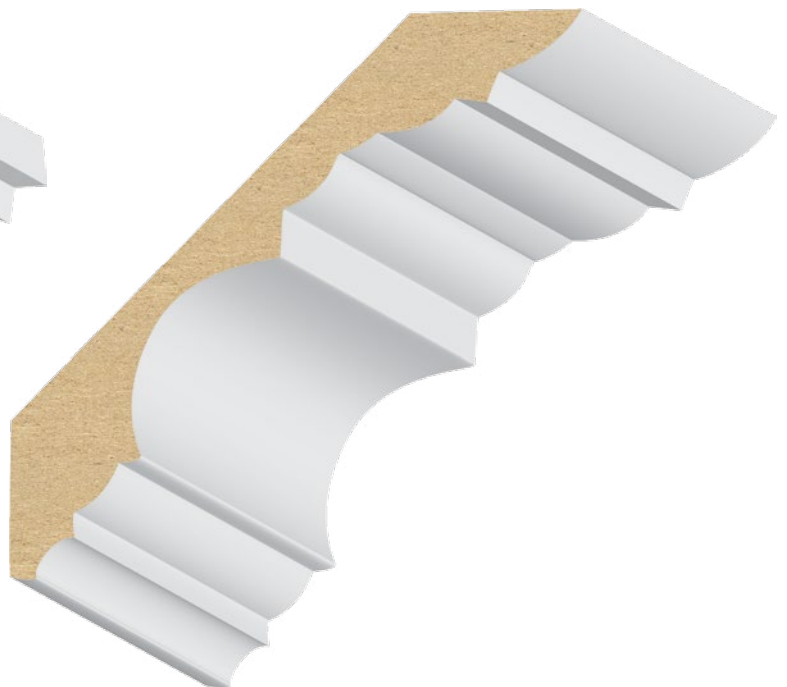

Tempe Crown 11/16 x 4-3/16
467MUL **NEW**

(items are approximate scale only)



4-1/4" to 4-1/2" CROWN & CORNICE

Lengths Available: 16'

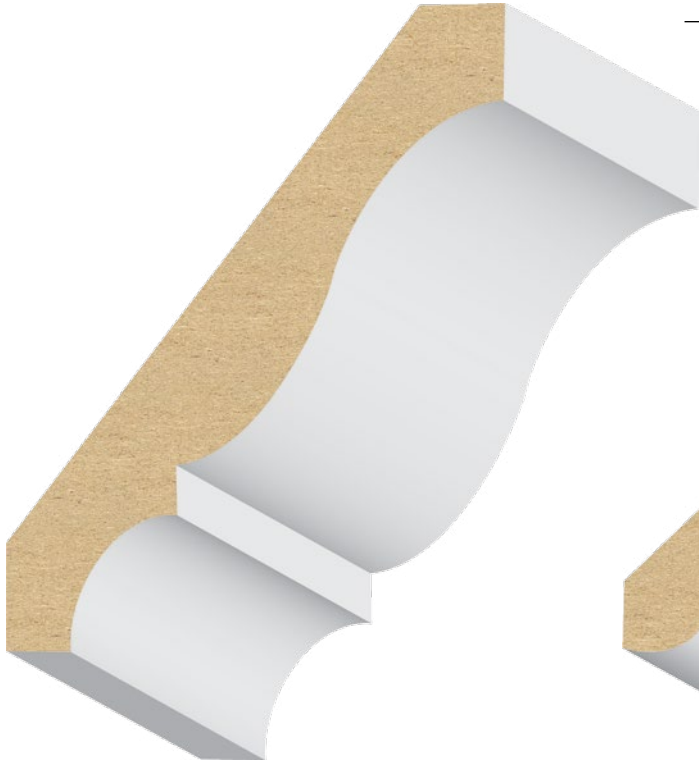

Colonial Crown 9/16 x 4-1/4
406MUL

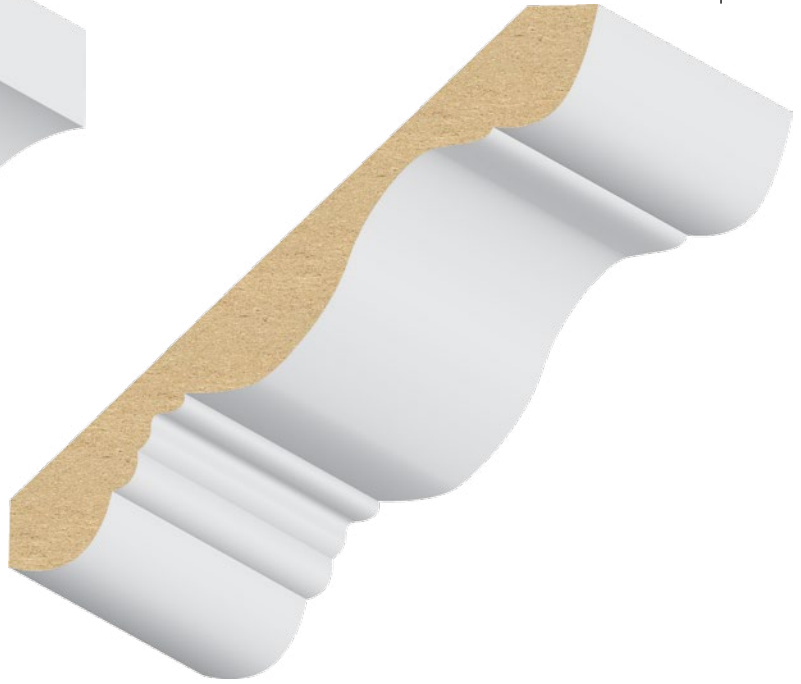

Small #410 Crown 9/16 x 4-1/4
413MUL
413LDF



Cornice 1-1/8 x 4-1/4
407MUL



Cornice 3/4 x 4-1/2
409MUL



4-1/2" to 4-5/8" CROWN & CORNICE

Lengths Available: 16'

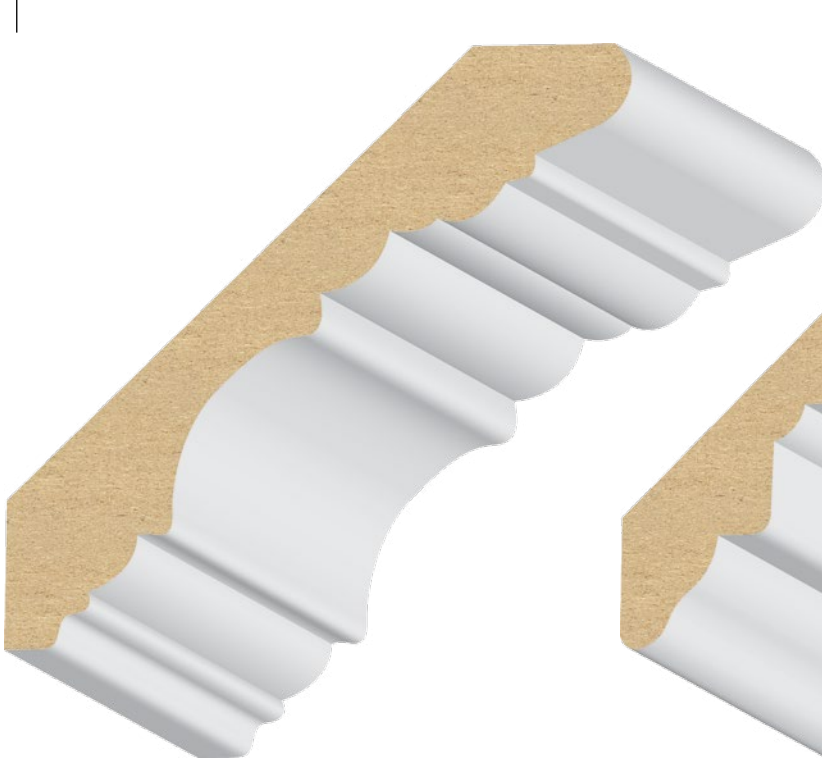

Georgian Crown 9/16 x 4-1/2
412MUL

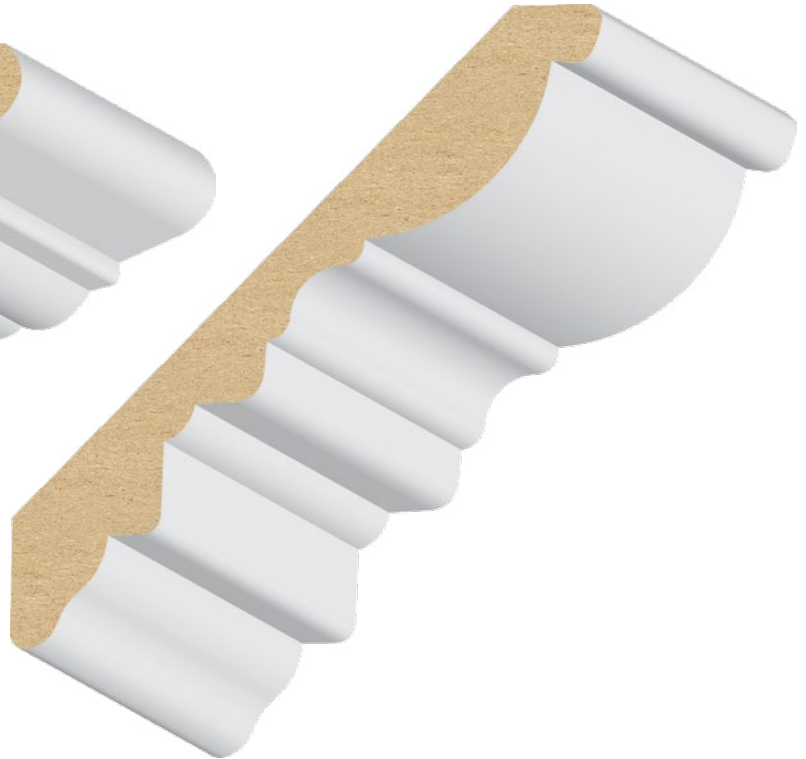

Savannah Crown 9/16 x 4-1/2
422MUL

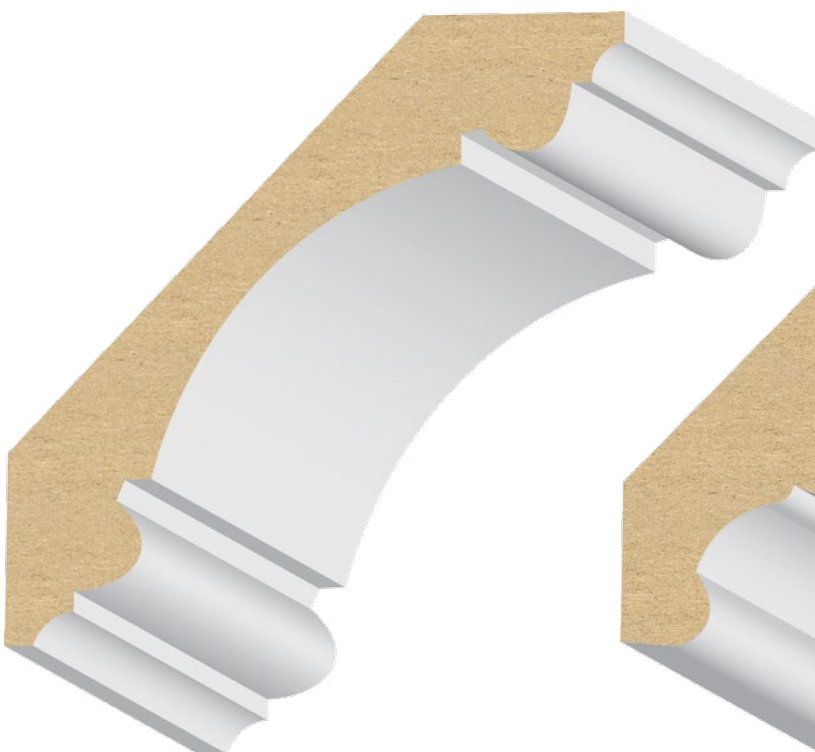

Carolina Crown 11/16 x 4-5/8
423LDF 7/8 x 4-5/8
423MUL



Single Bead Crown 1 x 4-1/2
430MUL

(items are approximate scale only)



4-5/8" to 4-11/16" CROWN & CORNICE

Lengths Available: 16'



Cornice
408MUL-4 7/8 x 4-5/8



Craftsman Crown 11/16 x 4-5/8
460MUL-4



Scottsdale Crown 3/4 x 4-11/16
469MUL **NEW**



4-15/16" to 5-1/16" CROWN & CORNICE

Lengths Available: 16'



King George Crown $3/16 \times 4-15/16$
465MUL-5 **NEW**



Charleston Crown $11/16 \times 5$
410MUL-5 **NEW**



Dentil Crown $11/16 \times 5-1/16$
455LDF

(items are approximate scale only)



5-1/4" to 5-1/2" CROWN & CORNICE

Lengths Available: 16'

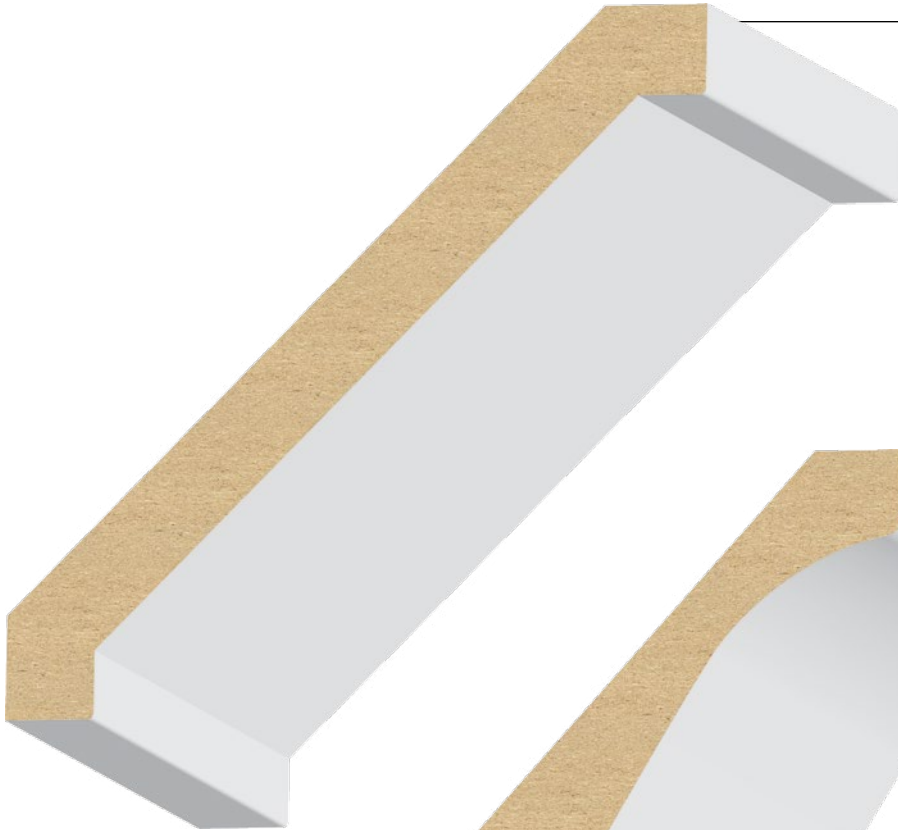

Craftsman Crown 11/16 x 5-1/4
460MUL-5



Colonial Crown 9/16 x 5-1/4
414MUL

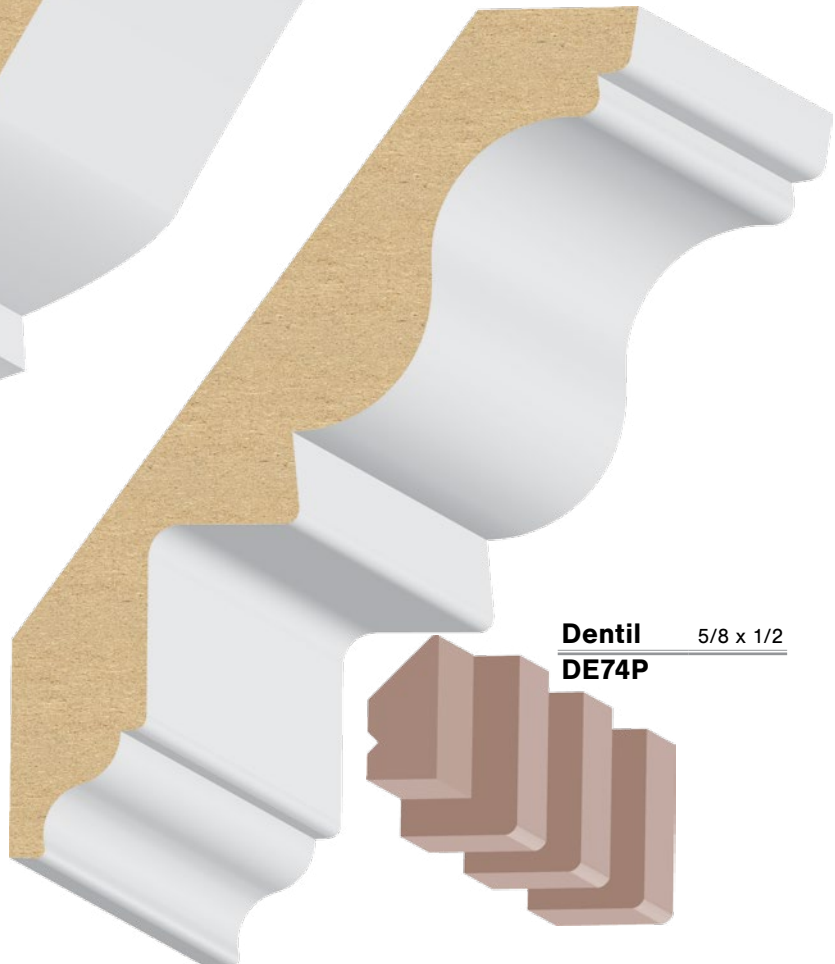

Dentil Ready Crown 13/16 x 5-1/2
425MUL-5

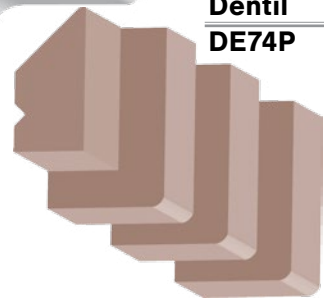

Dentil 5/8 x 1/2
DE74P



5-5/8" to 5-7/8" CROWN & CORNICE

Lengths Available: 16'



**Contemporary
Crown**
444MUL

1-1/4 x 5-5/8



Crown

410MUL
410LDF

11/16 x 5-7/8

11/16 x 6

(items are approximate scale only)



6" CROWN & CORNICE

Lengths Available: 16'



Cornice
408MUL

15/16 x 6



La Costa Crown
453MUL

1-1/8 x 6



6-1/4" to 6-1/2" CROWN & CORNICE

Lengths Available: 16'

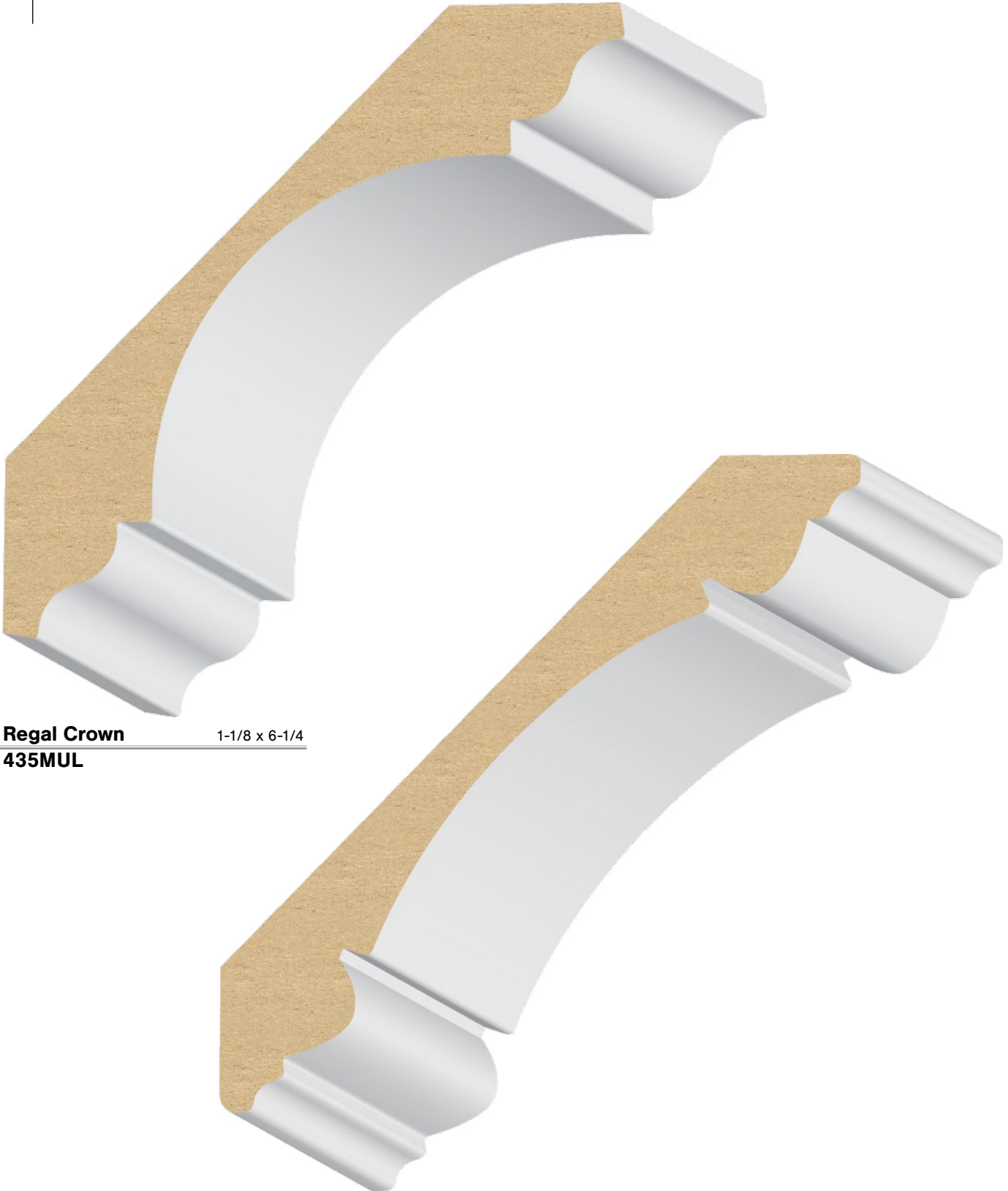

Regal Crown
435MUL

1-1/8 x 6-1/4

Carolina Crown
424MUL

1 x 6-1/2

(items are approximate scale only)



6-1/2" CROWN & CORNICE

Lengths Available: 16'



Georgian Crown 3/4 x 6-1/2
427MUL



Colonial Crown 9/16 x 6-1/2
416MUL



6-9/16" to 6-3/4" CROWN & CORNICE

Lengths Available: 16'

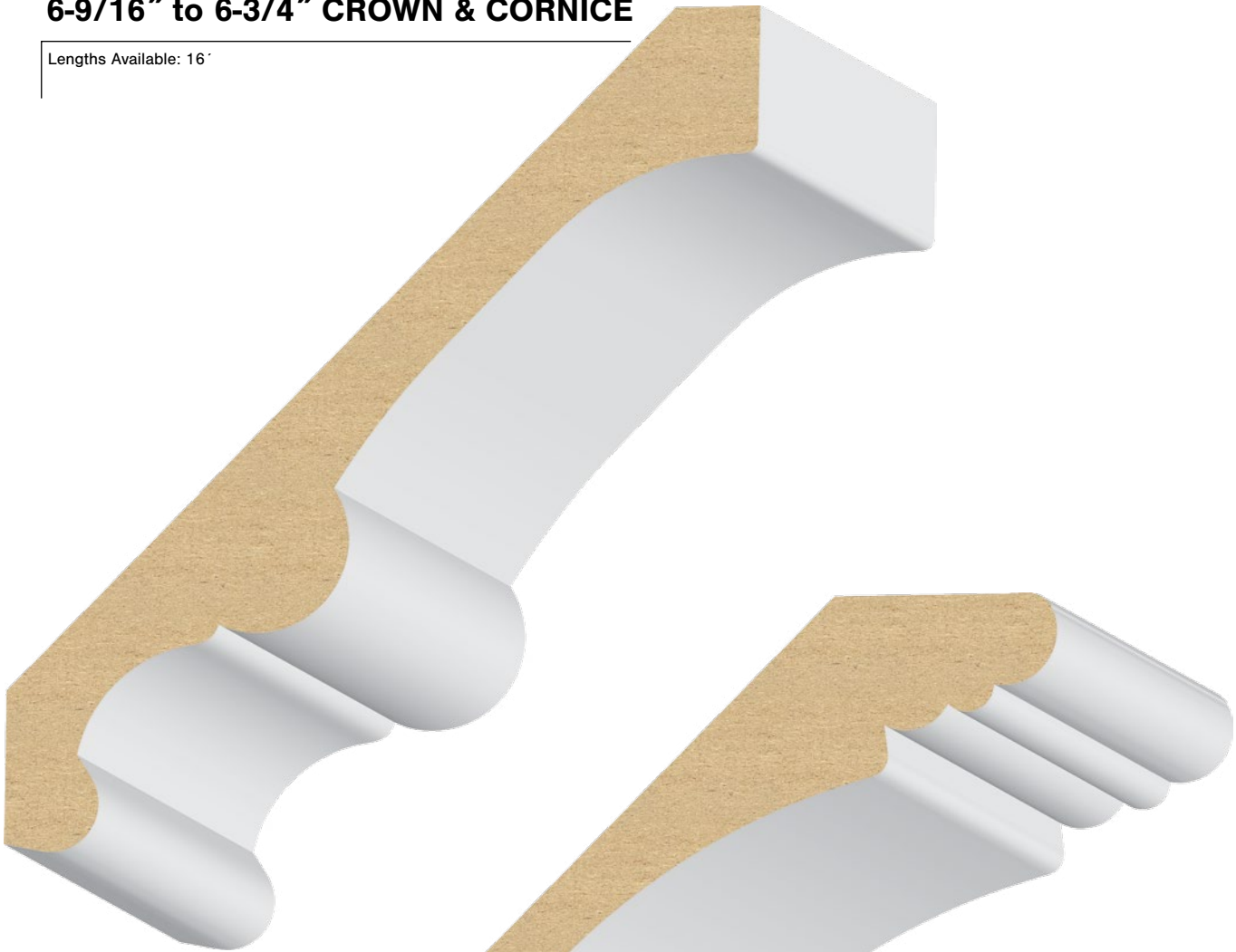

Single Bead Crown 7/8 x 6-9/16
431MUL

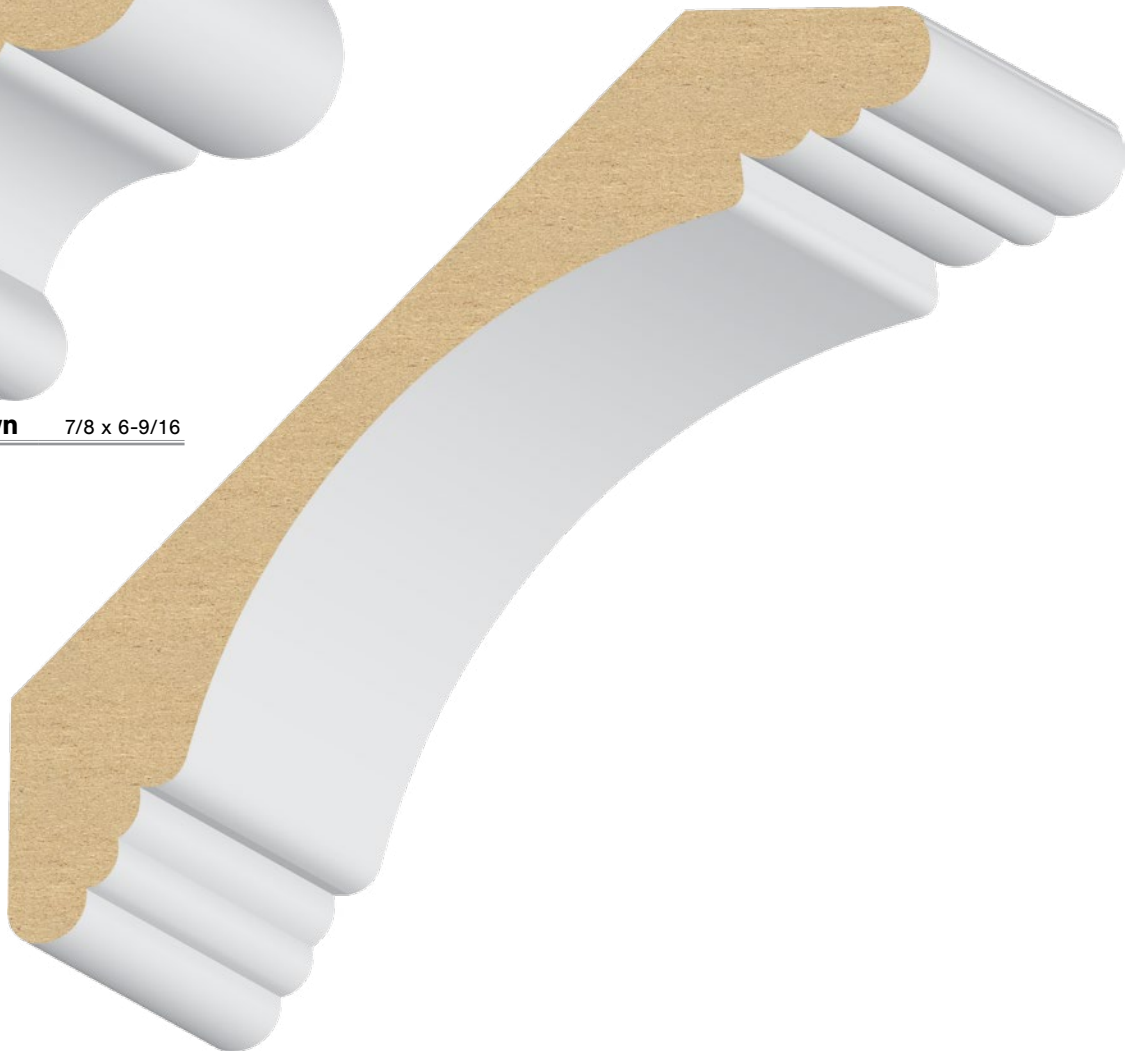

Del Mar Crown 1 x 6-3/4
433MUL

(items are approximate scale only)



7" to 7-1/4" CROWN & CORNICE

Lengths Available: 16'

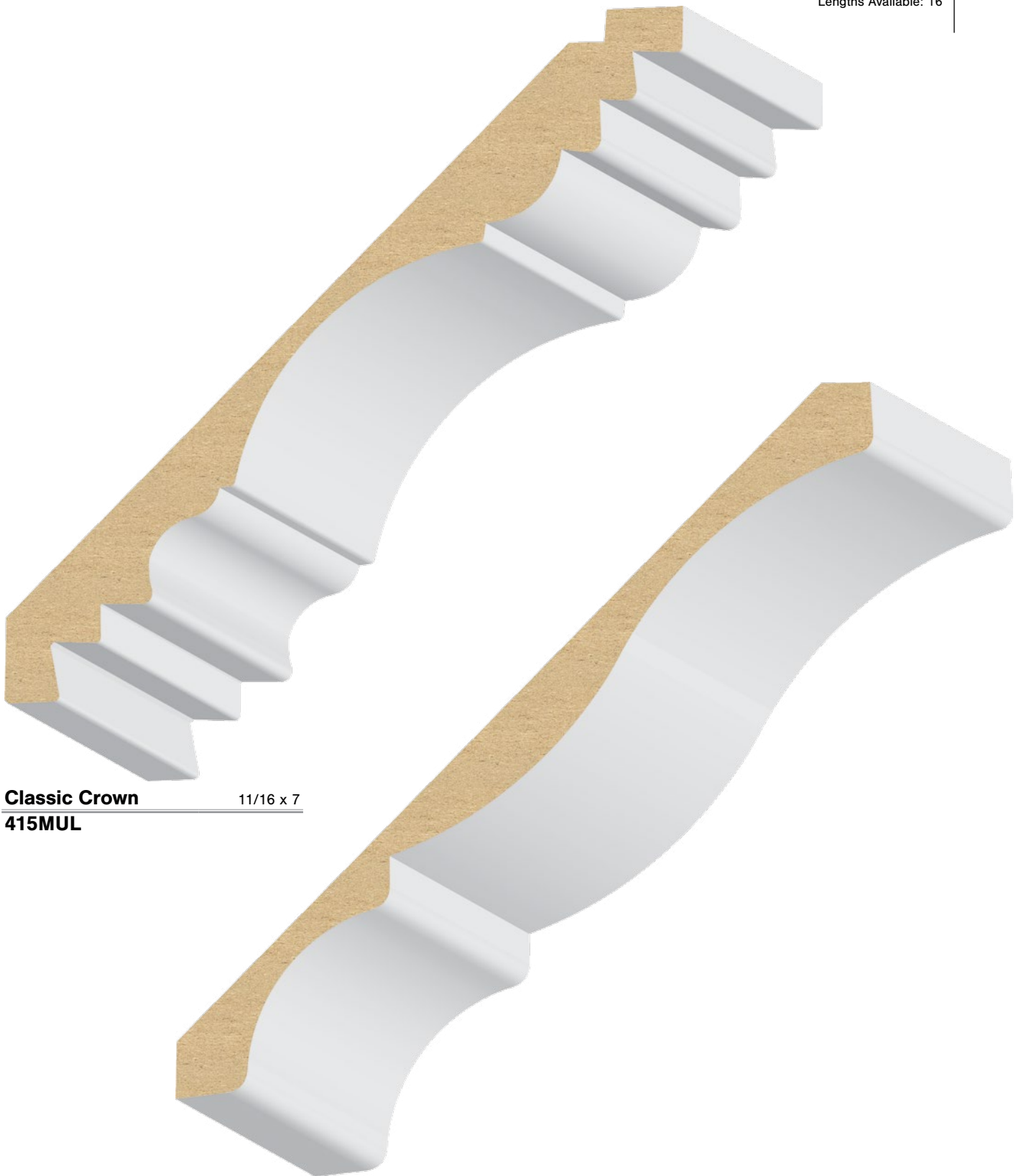

Classic Crown 1 1/16 x 7
415MUL

Colonial Crown 9/16 x 7-1/4
417MUL



7-1/4" CROWN & CORNICE

Lengths Available: 16'



**Contemporary
Crown**
445MUL

1-1/4 x 7-1/4

King George Crown 1-1/4 x 7-1/4
465LDF-7 **NEW**

(items are approximate scale only)



8" CROWN & CORNICE

Lengths Available: 16'

Georgian Crown 1-1/16 x 8
428MUL

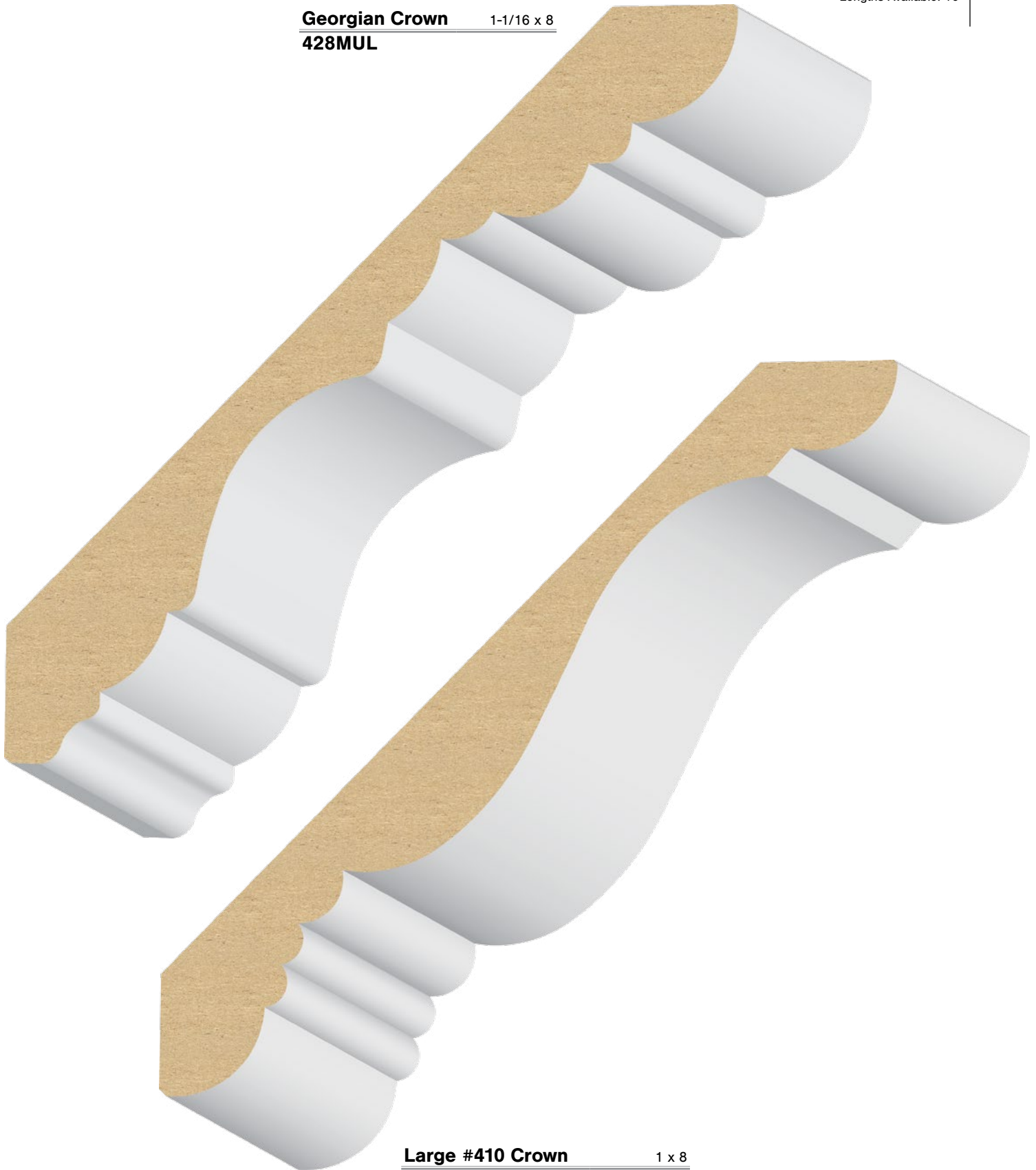

Large #410 Crown 1 x 8
450MUL



8-1/2" CROWN & CORNICE

Lengths Available: 16'



Corona Crown 1-1/8 x 8-1/2
432MUL

(items are approximate scale only)



8-1/2" to 8-7/8" CROWN & CORNICE

Lengths Available: 16'

Del Mar Crown
454MUL

1-1/8 x 8-1/2

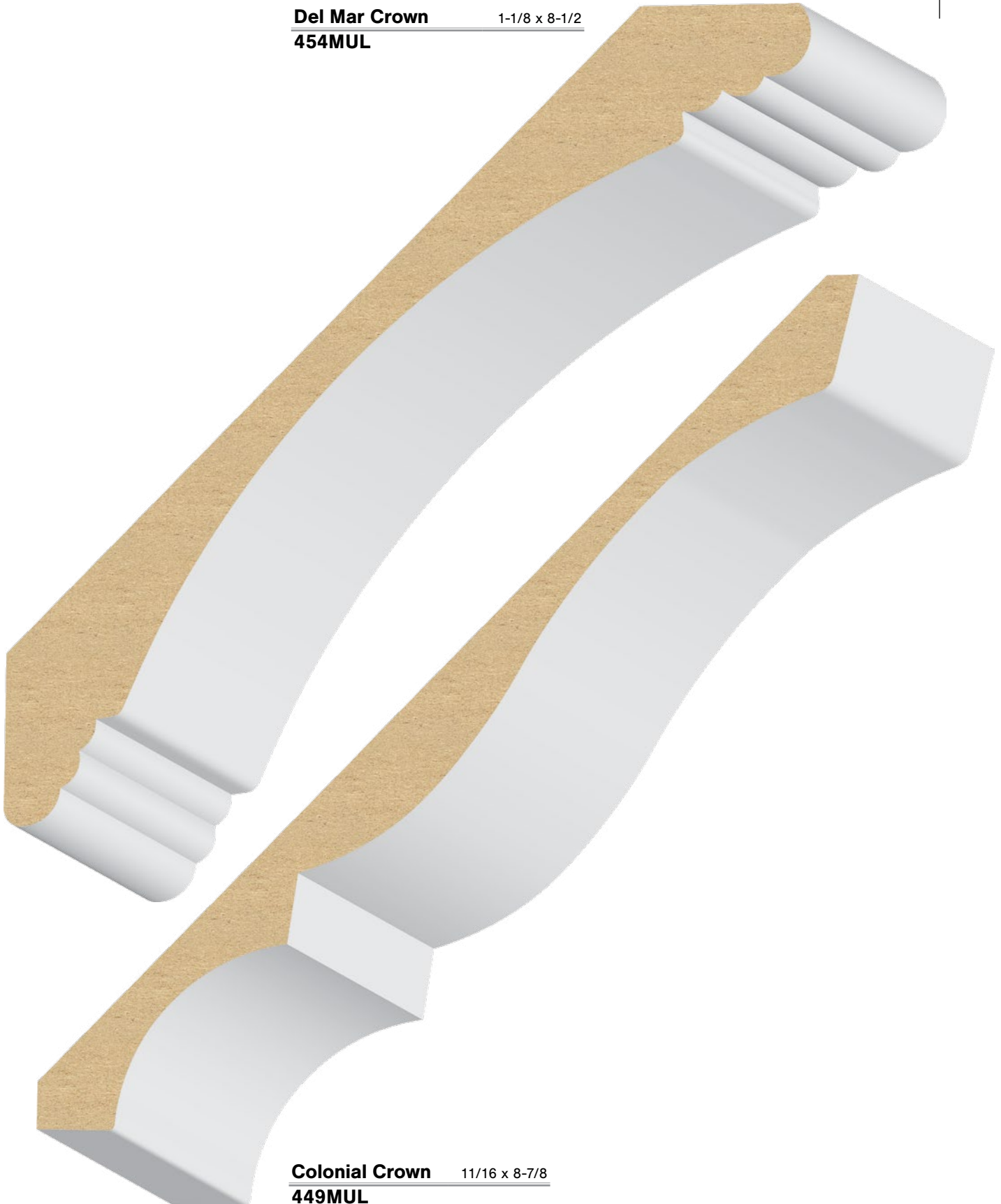

Colonial Crown
449MUL

1 1/16 x 8-7/8



11-1/4" CROWN & CORNICE

Lengths Available: 16'

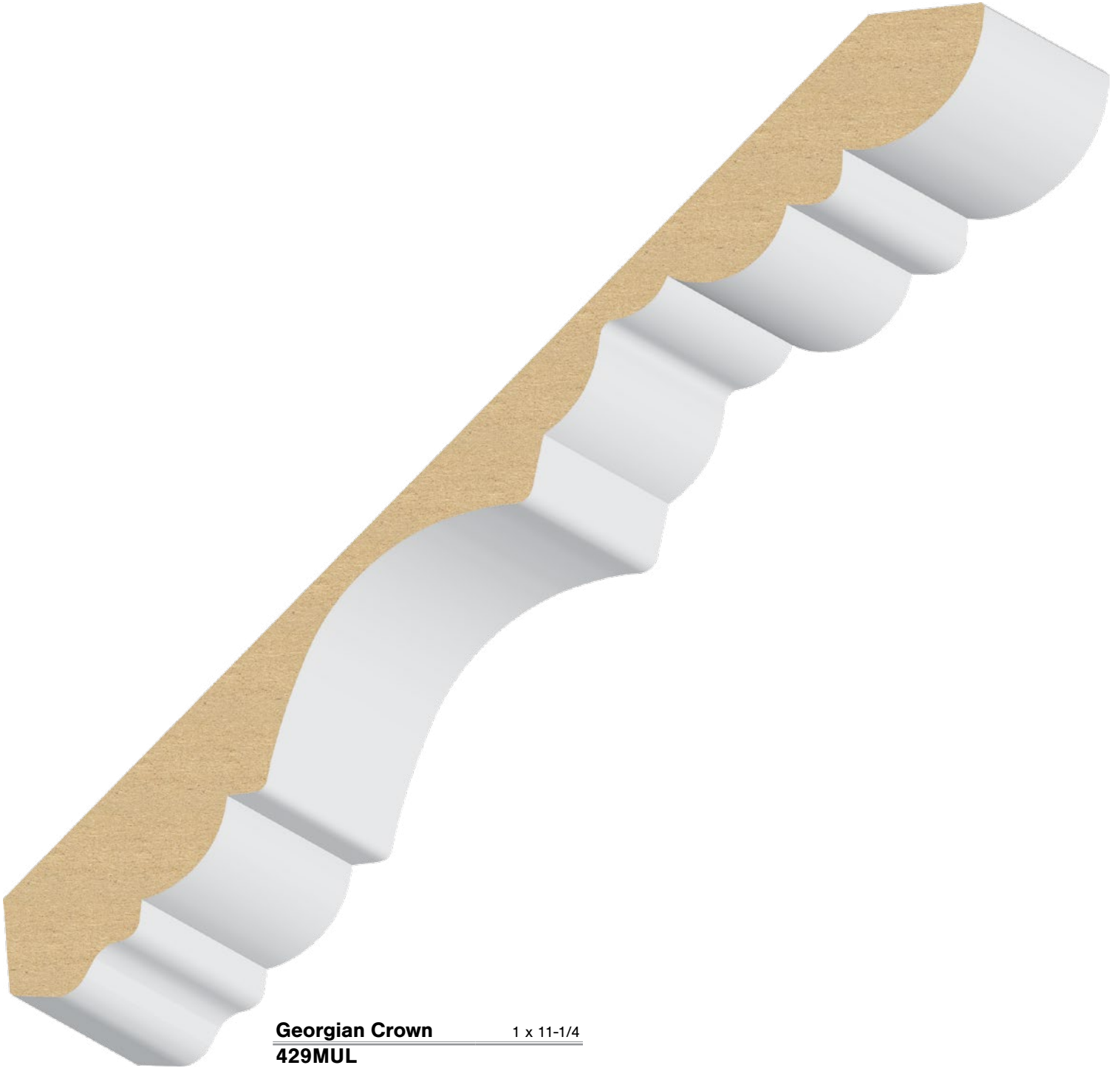

Georgian Crown
429MUL

1 x 11-1/4

(items are approximate scale only)



CHAIR RAIL

Lengths Available: 16'



Chair Rail
651MUL

9/16 x 2-1/2



Colonial Chair Rail
655MUL

9/16 x 2-5/8



**Bead & Barrel
Chair Rail**
649MUL

11/16 x 3



Colonial Chair Rail
653MUL

11/16 x 3



**Bolection Chair
Rail**
648MUL

1 x 3



Malibu Chair Rail
647MUL

1 x 3-1/2



PANEL CAP

Lengths Available: 16'

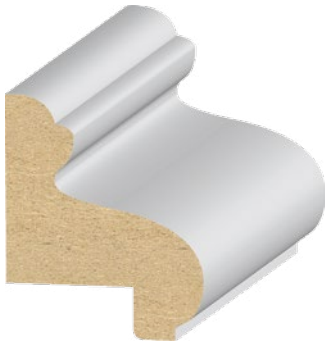

Raised Panel Cap
(w/11/16" Rab't)

1-1/8 x 1-1/4

739MUL



Wainscotting Cap
(w/5/16" x 5/8" Rab't)

1-1/8 x 1-3/4

738MUL



Wainscotting Cap
(w/1/2" x 9/16" Rab't)

3/4 x 2

737MUL



Panel Mold
(w/3/4" Rab't)

1-1/4 x 2

733MUL



Wainscot Cap
(w/3/8" Rab't)

9/16 x 2-1/4

729LDF



Panel Cap
(w/3/8" Rab't)

1 x 2-1/2

734MUL

(items are approximate scale only)



T&G WAINSCOT & WAINSCOT BASE

Lengths Available: 7' & 17'



T&G Wainscot Base $1/2 \times 5$
736MUL



T&G Wainscot Base $1/2 \times 3-1/4$
735MUL



Beaded T&G Wainscot
2000LDF $3/8 \times 3-1/4$
2002LDF $3/8 \times 5-1/2$



Flat T&G Wainscot
2001LDF $3/8 \times 3-1/4$
2003LDF $3/8 \times 5-1/2$



Beaded T&G Wainscot $1/4 \times 7$
2005MUL



ASTRAGAL

Lengths Available: 7', 8' & 16'



Flat Astragal 11/16 x 1-5/8
660MUL

CLEAT

Lengths Available: 16'



1 Eased Edge Unprimed Cleat 9/16 x 1-1/2
10FB Fiberboard

HOOK

Lengths Available: 16'



1 Eased Edge Milled Hook 9/16 x 3-1/4
15FB Fiberboard

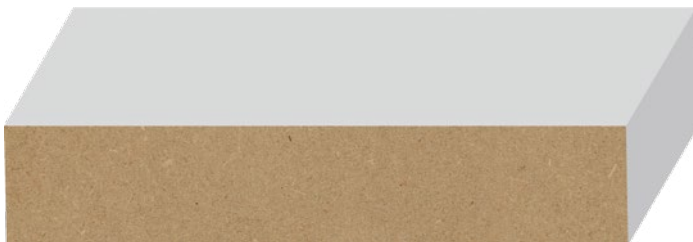

Melamine Hook 5/8 x 3-1/4
MLH Melamine

ROUND CORNER

Lengths Available: 8'



Round Corner w/ 3/4" Radius 3/4 x 1-13/16
8PBMDF Particle Board



WALL CAP

Lengths Available: 16'



Primed Eased 2 Edge Wall Cap

1098LDF	11/16 x 1-1/2	1104LDF	1-1/4 x 7-1/4
1099LDF	11/16 x 2-1/2	1106LDF	11/16 x 11-1/4
1100LDF	11/16 x 3-1/2	1107LDF	1-1/4 x 11-1/4
1101LDF	11/16 x 5-1/2	1108LDF	1-1/16 x 3-1/2
1102LDF	1-1/4 x 5-1/4	1109LDF	11/16 x 1-1/2
1103LDF	11/16 x 7-1/4	1110LDF	11/16 x 2-1/2

INTERIOR S4S

Lengths Available: 16'



Interior S4S Boards

713LDF	11/16 x 1-1/2	750LDF	11/16 x 5-1/2
714LDF	11/16 x 2-1/2	751LDF	11/16 x 7-1/4
715LDF	11/16 x 3-1/2	753LDF	11/16 x 11-1/4

STOOL

Lengths Available: 16'



Beveled Stool

986LDF	11/16 x 4-3/4	987LDF	11/16 x 6-3/4
---------------	---------------	---------------	---------------



Thick Beveled Stool Unprimed

988LDF	11/16 x 4-3/4	989LDF	11/16 x 6-3/4
---------------	---------------	---------------	---------------

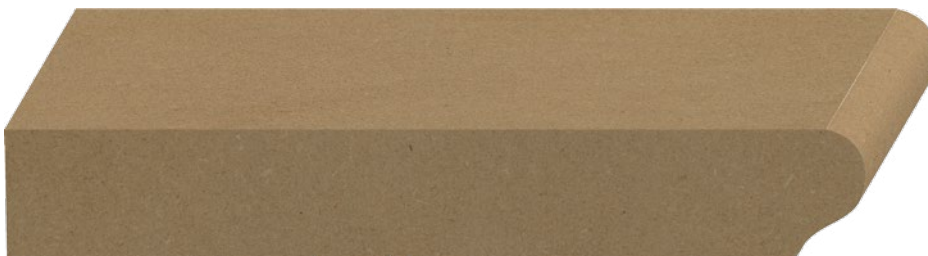

Raw Ogee Stool

990LDF	11/16 x 4-3/4	991LDF	11/16 x 6-3/4
---------------	---------------	---------------	---------------



SHELVING

Lengths Available: 16'



Bullnose Shelving

Unprimed MDF		Particle Board	
11MDF-BN	11/16x11-1/4	11PB	5/8x11-1/4
12MDF-BN	11/16x15-1/4	12PB	5/8x15-1/4
		13PB	5/8x23-1/4
		16PB	3/4x11-1/4
		17PB	3/4x15-1/4
		18PB	3/4x23-1/4



2 Eased Edge Shelving

Unprimed MDF	
11MDF	11/16x11-1/4
12MDF	11/16x15-1/4



Square Edge Shelving

Unprimed MDF	
13MDF	11/16x23-1/4

MELAMINE SHELVING



Melamine Shelving

MS1	5/8 x 11-1/4
MS2	5/8 x 15-1/4
MS3	5/8 x 23-1/4
MS4	3/4 x 11-1/4 [Available Lengths: 8', 12']
MS5	3/4 x 15-1/4 [Available Lengths: 8', 12']
MS6	3/4 x 23-1/4 [Available Lengths: 8', 12']

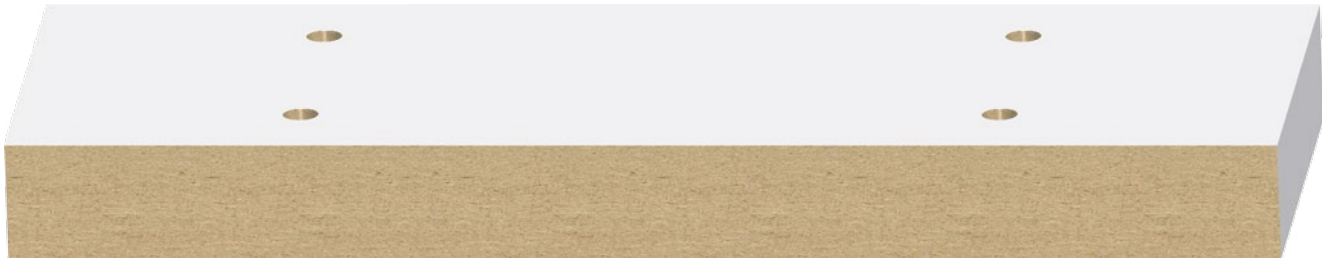

Melamine Pre-Drilled Dividers

All dividers come pre-drilled, all the way through.
Holes are 3/16" diameter (±1/16") and spaced 1-1/4" apart.

MD1	5/8 x 11-1/2	2 sets of Holes
MD2	5/8 x 15-1/2	2 sets of Holes
MD3	5/8 x 23-1/2	3 sets of Holes
MD4	3/4 x 11-1/2	2 sets of Holes
MD5	3/4 x 15-1/2	2 sets of Holes
MD6	3/4 x 23-1/2	3 sets of Holes

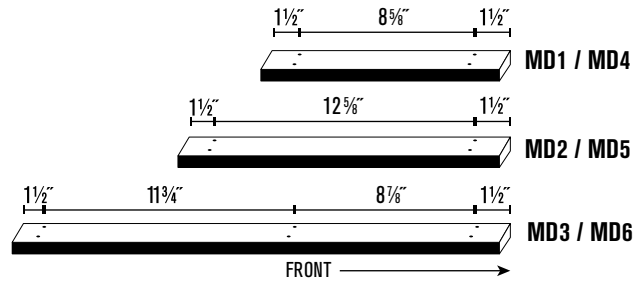



INTERIOR DOOR JAMB

Interior Door Jamb

Kerfing for bullnose is available on all jamb sizes and species. Custom size odd wall widths available upon request.



Specifications:

11/16" Thick

6/8 = 81" Below Dado

8/0 = 97" Below Dado

- Lineal - 17' = MDF, FJ Pine & Oak Veneer
- Solid Pine jambs may have a glue line where door stop is applied.
- Random Lengths only available in most solid wood species
- Dado depth = 3/8"
- Heads cut 3/4 over opening
- 5 pair per bundle

SIZE	6/8	8/0	17' LINEAL
4-9/16	4916MI6	4916MI8	4916MIL
4-3/4	434MI6	434MI8	434MIL
5-1/4	514MI6	514MI8	514MIL
6-9/16	6916MI6	6916MI8	6916MIL
7-1/4	714MI6	714MI8	714MIL

BUILD-UPS

Build-ups allow you to combine multiple moulding profiles to produce customized looks that are easy to create, without the expense of a custom milling solution.

Build-up combinations for ceiling, door, and floor applications can consist of a wide variety of arrangements. By using different combinations of Crown, Base, Casing, S4S, Chair Rail, and Panel Mold, you can make a more impressive statement with your moulding choices.

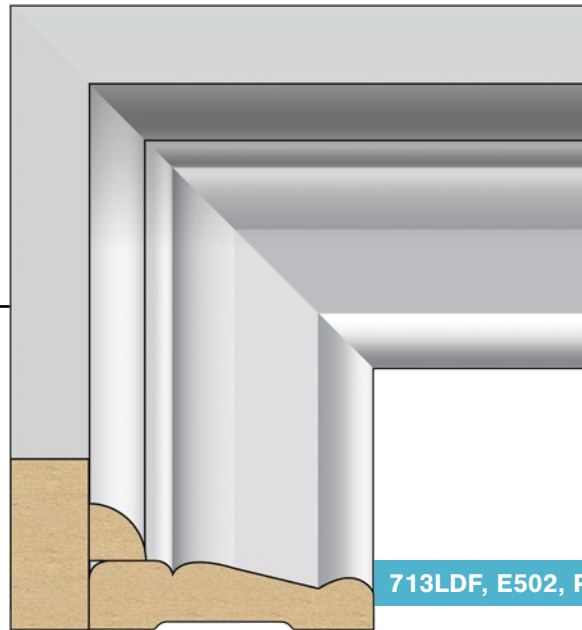



BUILD-UPS

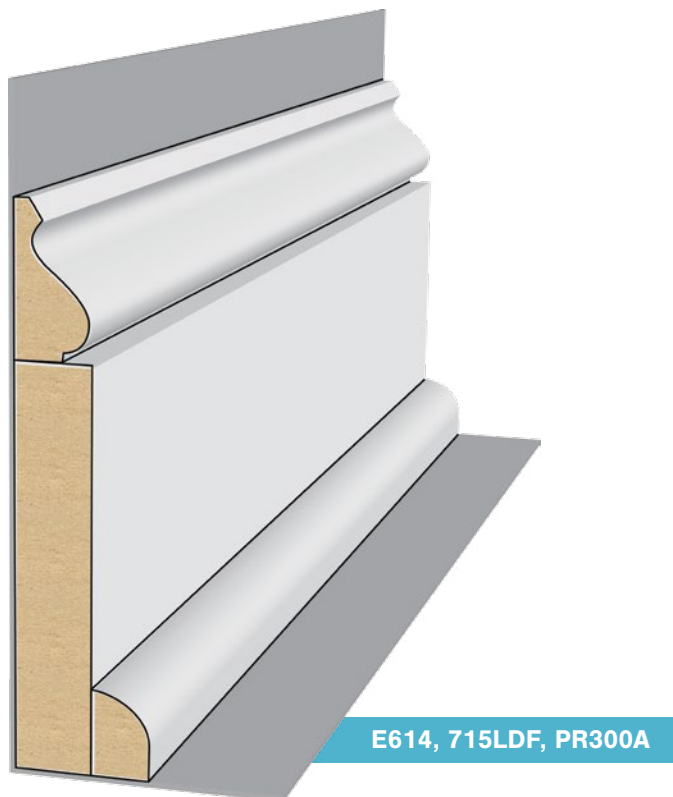

(items are approximate scale only)



BUILD-UPS

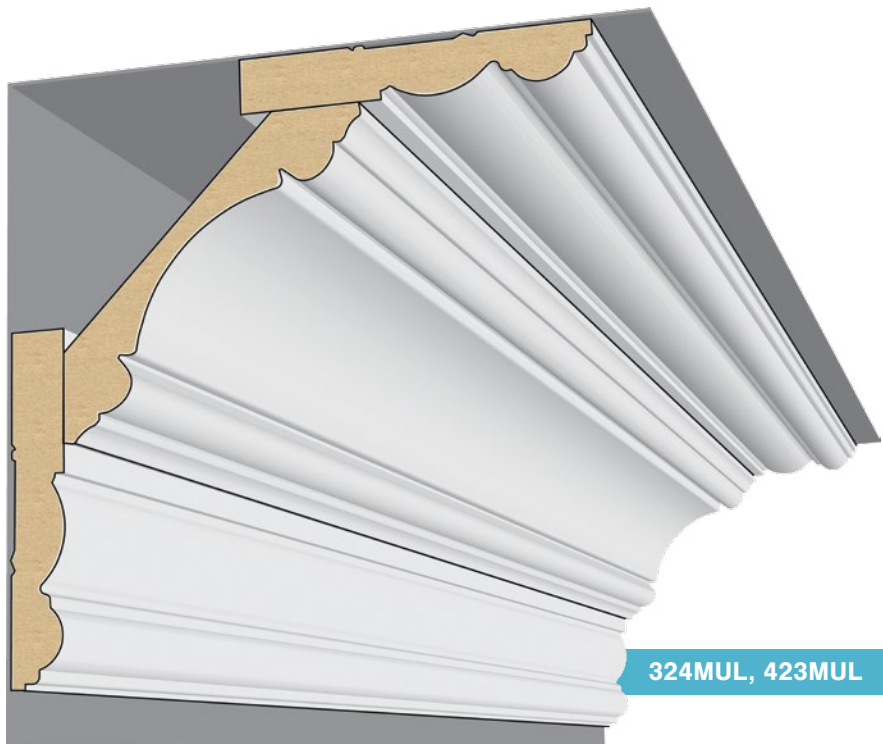
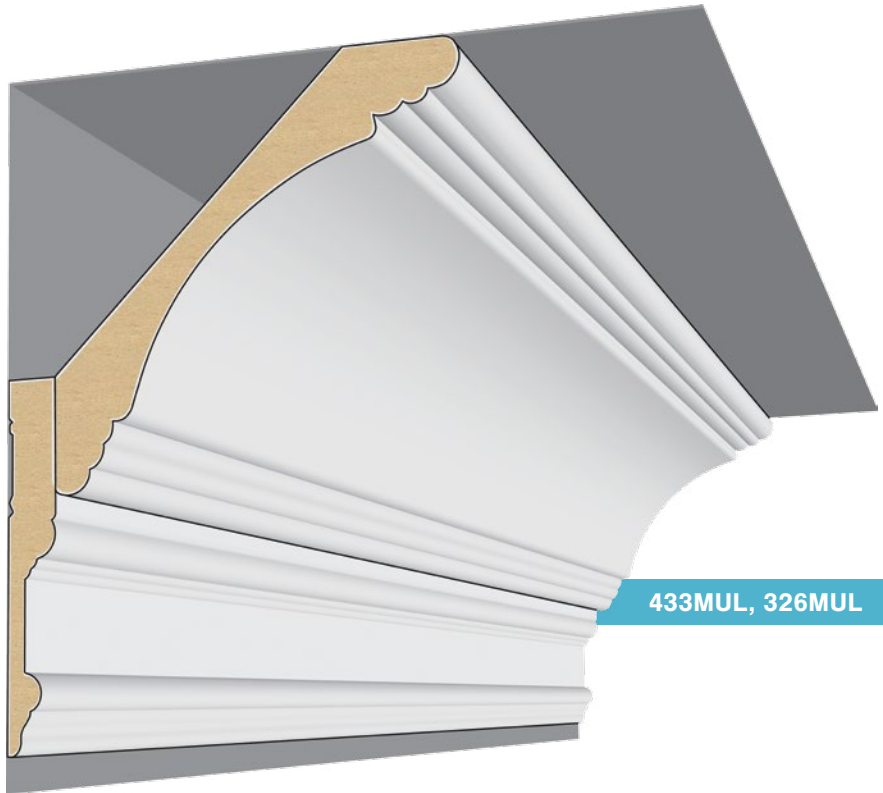



IDEAS

A large grid of 20 columns and 30 rows, intended for drawing ideas. The grid is composed of thin, light gray lines forming a uniform pattern across the page.

VG **Doug Fir & Redwood**

STRONG AND DURABLE INSIDE AND OUT



Inside

Astragal.....	185
Base	182
Brick Mold.....	188
Casing.....	181
Crown.....	183-184
Cove	184
Door Stop.....	181
Exterior Mold	189
Full Round.....	183
Handrail	186-187
Panel Cap.....	181
Quarter Round	183
Redwood Exterior Mold.....	181
Redwood Lattice.....	191
Redwood Sill.....	191
Redwood Water Table.....	184
S4S (Unprimed).....	187
T&G Wainscot.....	184



VG **Doug Fir** & **Redwood**

STRONG AND DURABLE INSIDE AND OUT



Vertical Grain Douglas Fir (denoted by a VG in the part number), as its name implies, features a vertical (up and down) grain pattern, giving it more consistent coloration and increased stability and durability. The vertical grain helps the wood to expand and contract evenly throughout the board in response to natural moisture in the air.

Handrails and Full Round are made of mixed grain Douglas Fir which include some vertical grains, but will also have swirl in the grain.

Douglas Fir, considered part of the softwood family, has long been used as a closet pole because of its extreme strength. VG or Douglas Fir can be painted or stained beautifully.

Redwood's rot resistant properties lend itself to exterior applications such as Brick, Stucco, and Siding Molds, as well as, Window Sills and Watertable, and Exterior Lattice work.

Durable and resistant to certain wood eating mites, Redwood is usually milled "green", which means a high moisture content. This often causes a darkening of the Redwood, in time, even blackening. It is important to paint or stain Redwood to keep a good appearance.

STRONG AND DURABLE

STAINS BEAUTIFULLY

RICH VISUAL QUALITY

(items are approximate scale only)



CASING

Lengths Available: 5' thru 16'



2 Round Edge Casing 9/16 x 2-1/4
120VG

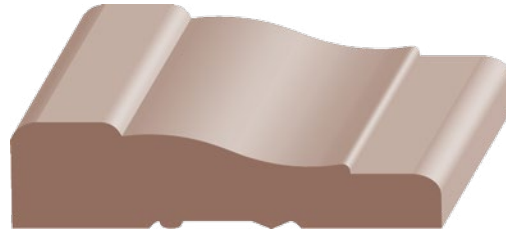

#356 Casing 11/16 x 2-1/4
152VG

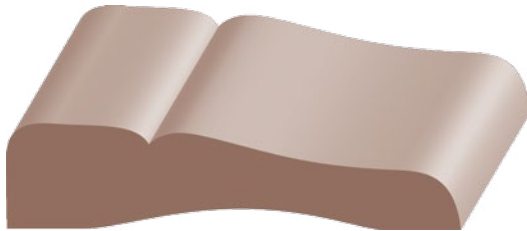

#711 Casing 5/8 x 2-1/2
108VG

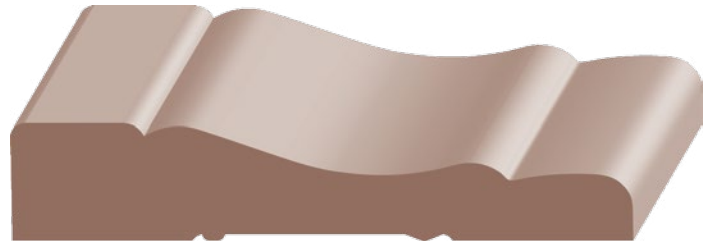

#365 / Moulded Casing 5/8 x 3-1/4
176VG



2 Round Edge Casing 11/16 x 3-1/2
139VG

PANEL CAP

Lengths Available: 5' thru 20'

STOP

Lengths Available: 3' thru 16'



1 Round Edge Stop 1/2 x 1-1/2
209VG

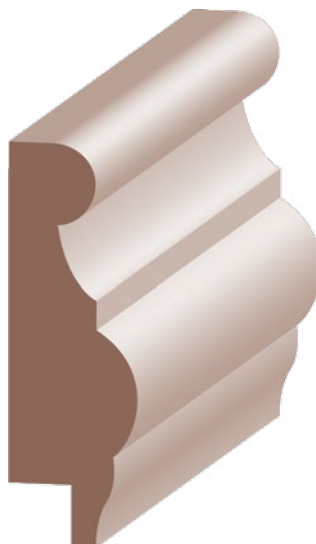

Panel Cap 11/16 x 2-1/8
(for 3/8" Wainscot)
620VG

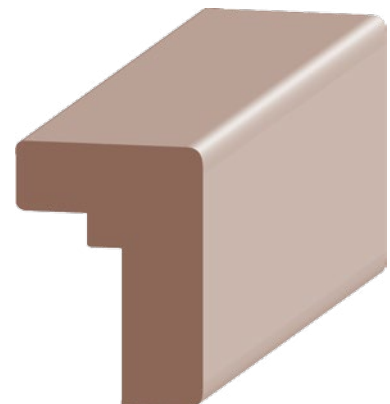

Craftsman Cap 1 x 1-3/8
(for 9/16" Wainscot)
623VG



BASE & BASE SHOE

Lengths Available: 5' thru 16'

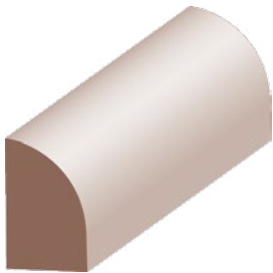

Base Shoe $7/16 \times 11/16$
300BVG

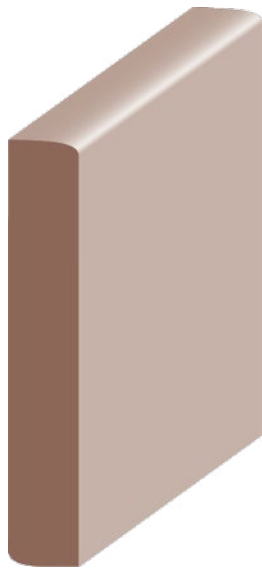

Reversible Base $3/8 \times 2-1/4$
R304VG-2



#711 Base $1/2 \times 2-1/2$
310VG

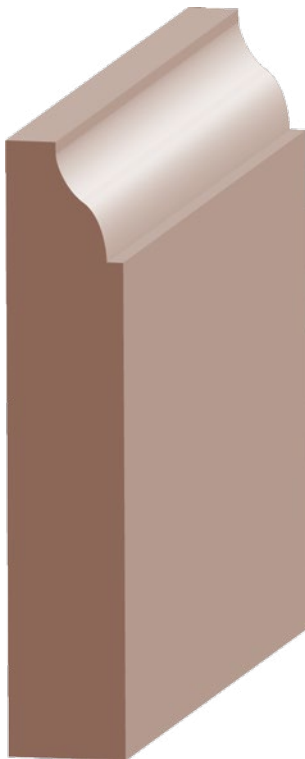

Coronado Base $9/16 \times 3-1/4$
314VG-3

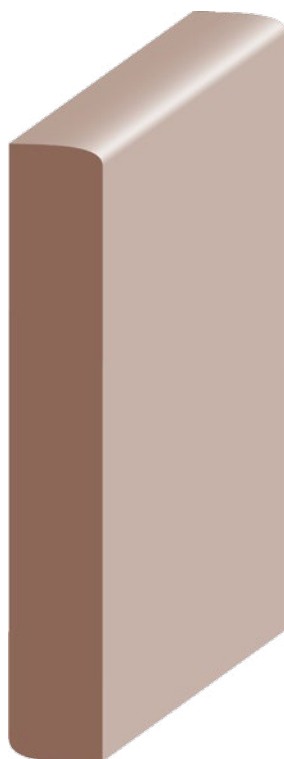

Reversible Base $1/2 \times 3-1/4$
R306VG-3

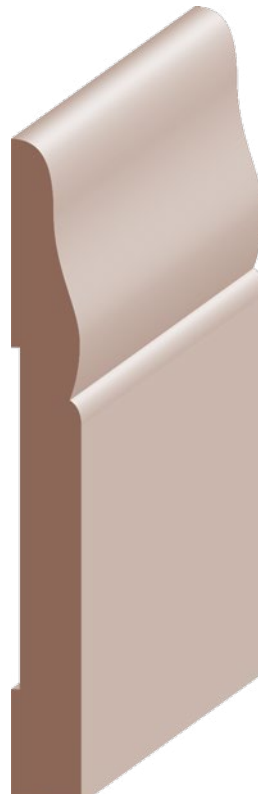

#711 Base $1/2 \times 3-1/2$
311VG

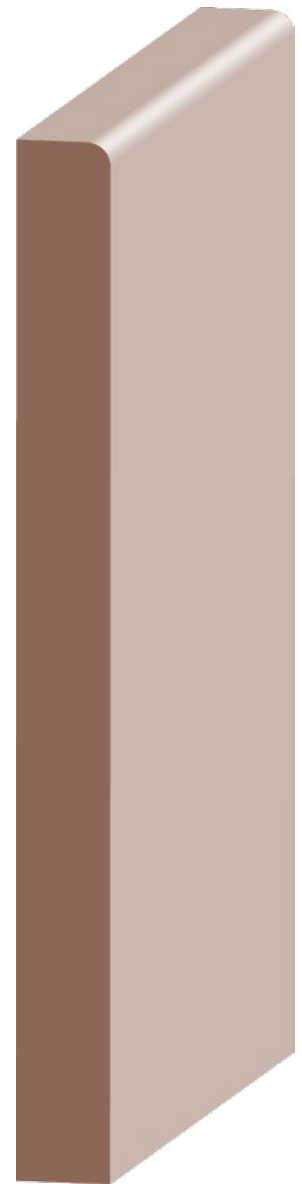

1 Round Edge Base $1/2 \times 5-1/2$
388VG

(items are approximate scale only)

4-3/4" to 5-1/4" CROWN

Lengths Available: 5' thru 16'

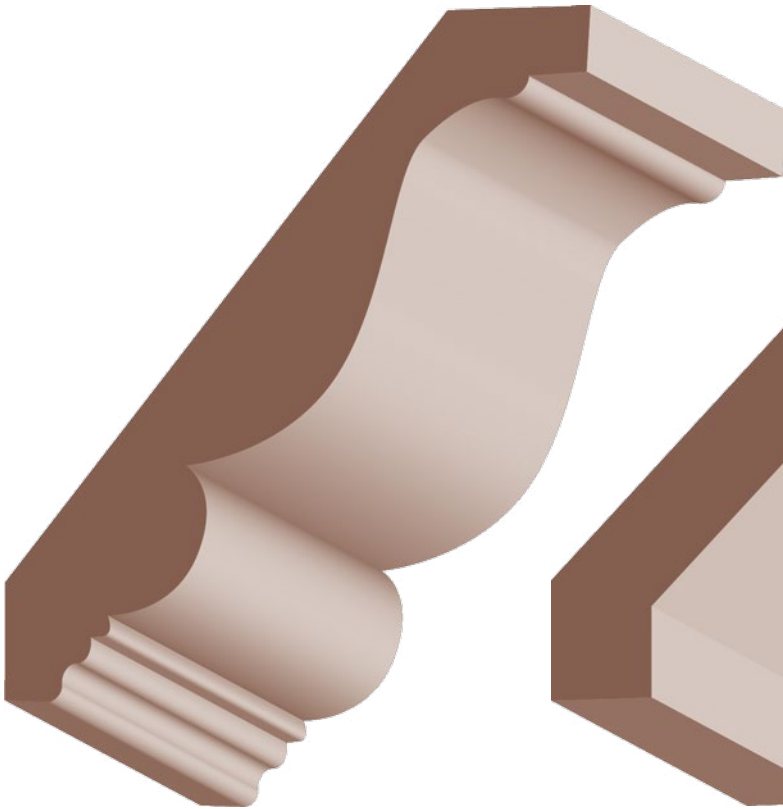

Imperial Crown 11/16 x 4-3/4
CR810P

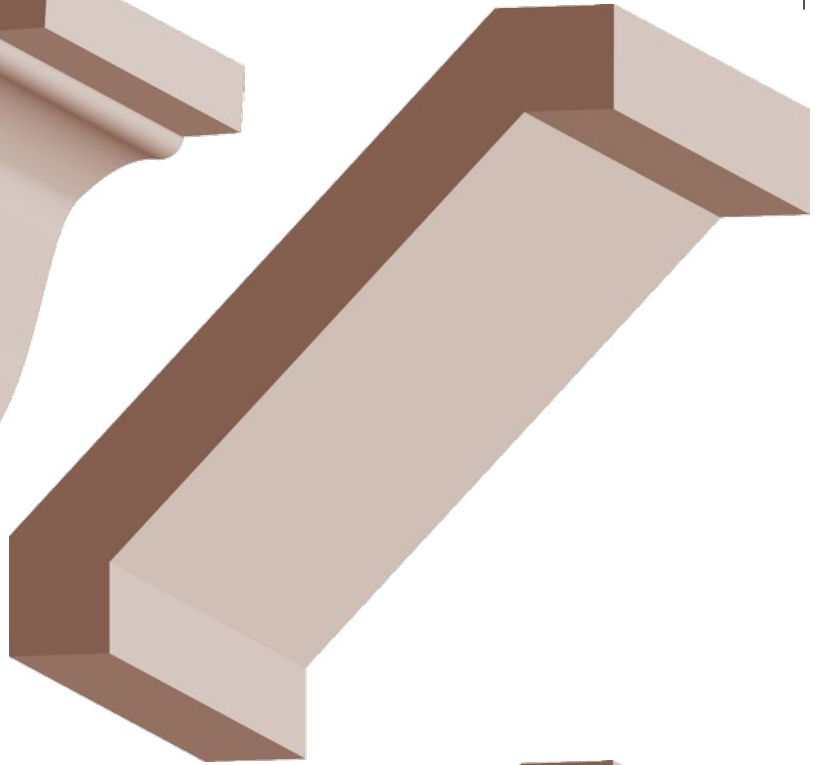

Craftsman Crown 11/16 x 4-5/8
460VG



Colonial Crown 5/8 x 5-1/4
414VG



7-1/4" CROWN

Lengths Available: 5' thru 16'

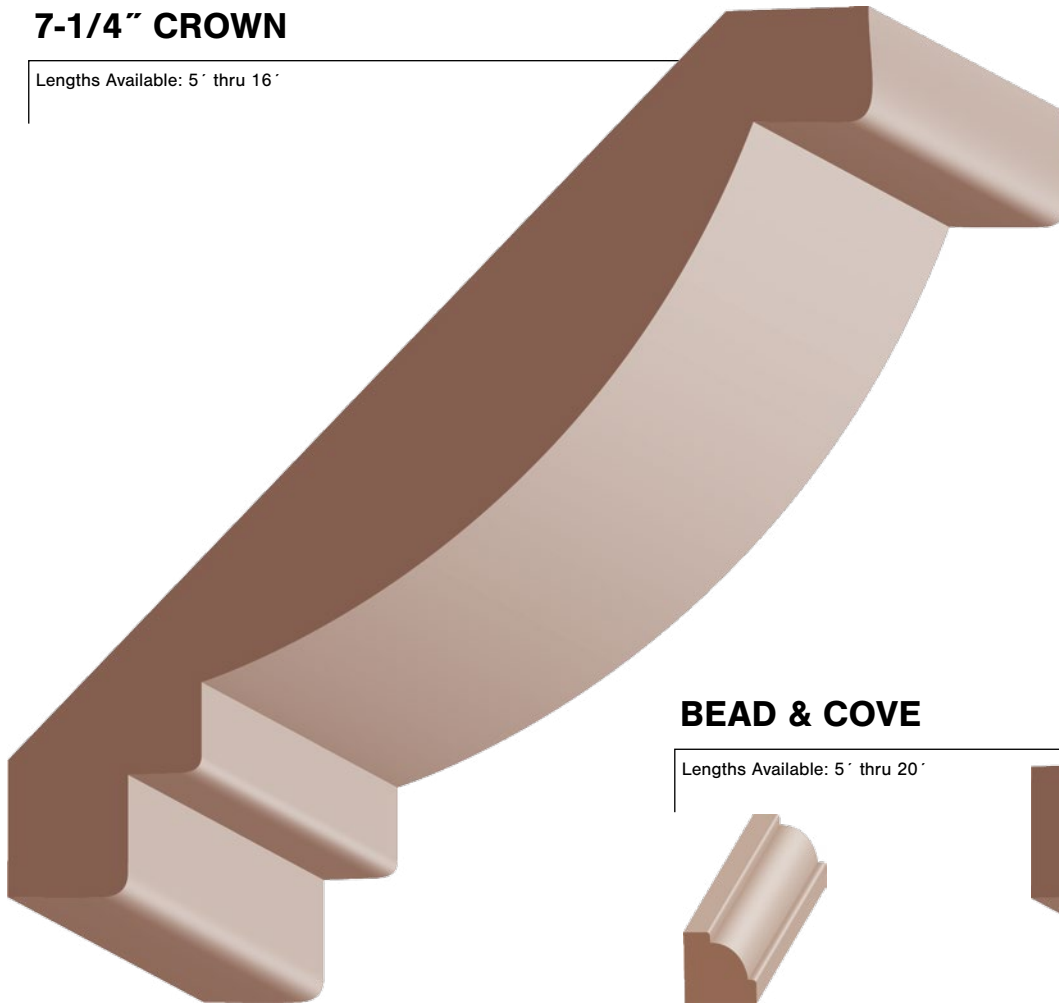

Tahoe Crown 1 x 7-1/4
462VG

BEAD & COVE

Lengths Available: 5' thru 20'

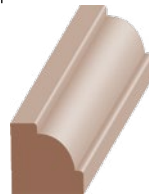

Ovolo Sticking 3/8 x 3/8
599VG

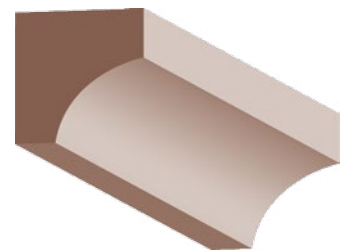

Cove 11/16 x 11/16
523VG

T&G WAINSCOT

Lengths Available: 5' thru 16'



Reversible Beaded T&G Wainscot (Reversible) 3/8 x 3-1/4
2000VG

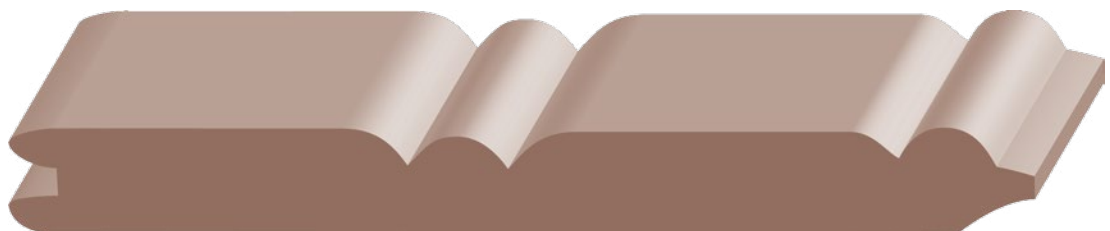

Reversible Beaded T&G Wainscot (Reversible) 9/16 x 5-3/8
2003VG

(items are approximate scale only)



ASTRAGAL

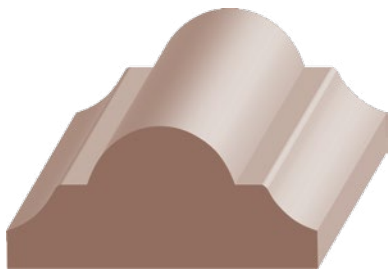

Flat Astragal
 [Lengths Available: 7' and 8'] 3/4 x 1-5/8
660VG

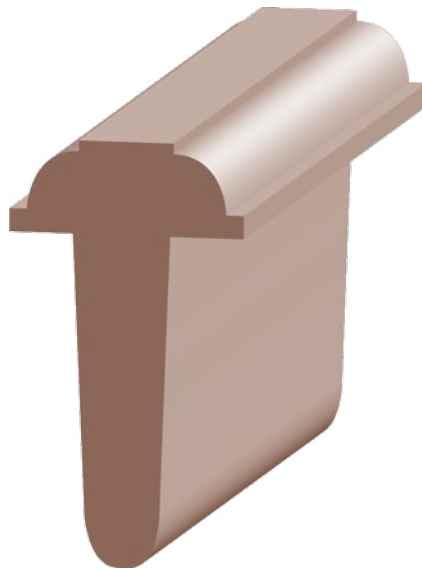

T-Astragal for 1-3/4" Doors
 [Lengths Available: 7', 8', or 12' only] 1-1/4 x 2-1/4
661VG

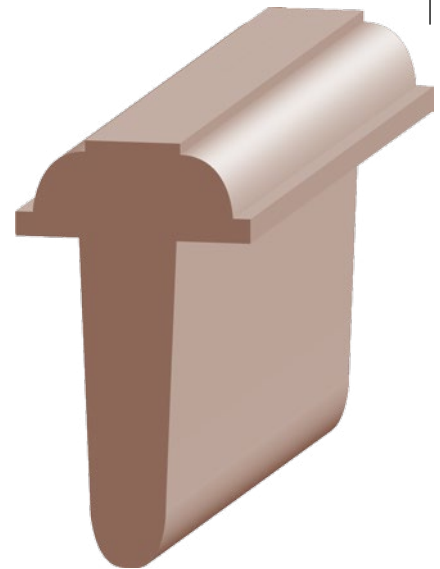

T-Astragal for 1-3/8" Doors
 [Lengths Available: 7' and 8'] 1-1/4 x 2
662VG

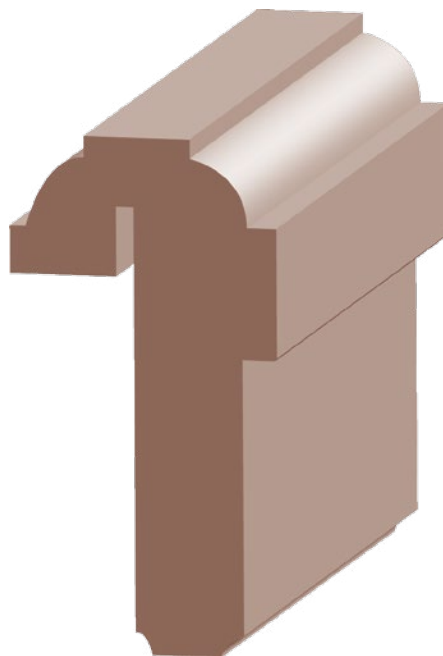

T-Astragal w/ Weatherstrip Kerf for 1-3/4" Doors
 (Q-Lon® weatherstrip not included)
 [Lengths Available: 7', 8', 10', and 12' only] 1-1/2 x 2-7/8
663VG

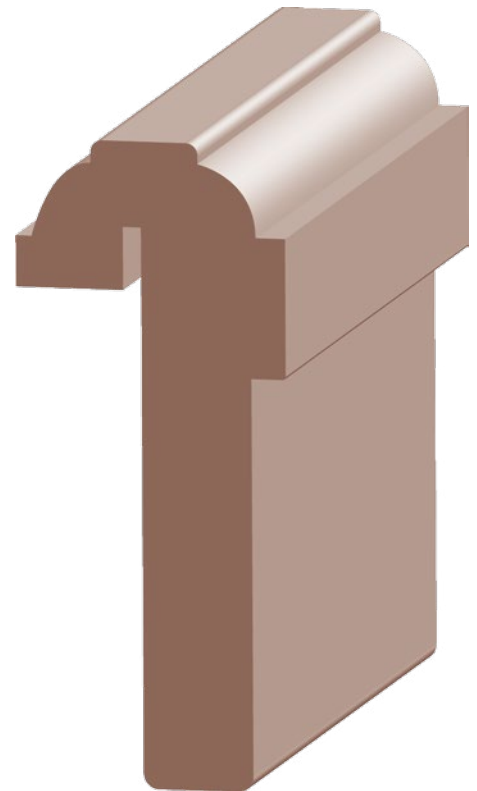

T-Astragal w/ Weatherstrip Kerf for 2-1/4" Doors
 (Q-Lon® weatherstrip not included)
 [Lengths Available: 10' and 12' only] 1-1/2 x 3-3/8
664VG

Q-Lon® for T-Astragal	
TQ7B	81" Brown
TQ7W	81" White
TQ8B	97" Brown
TQ8W	97" White



HANDRAIL

Lengths Available: 5' thru 20'

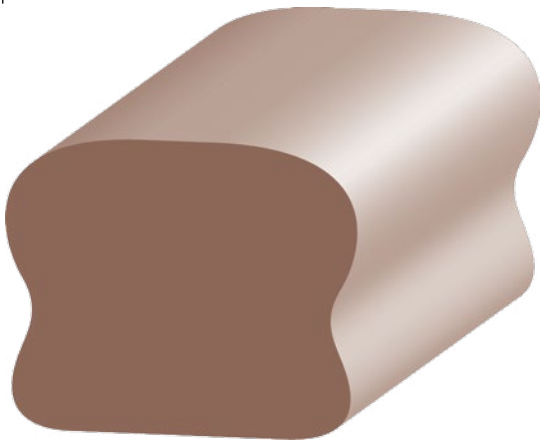

Small Handrail 1-1/2 x 1-7/8
926

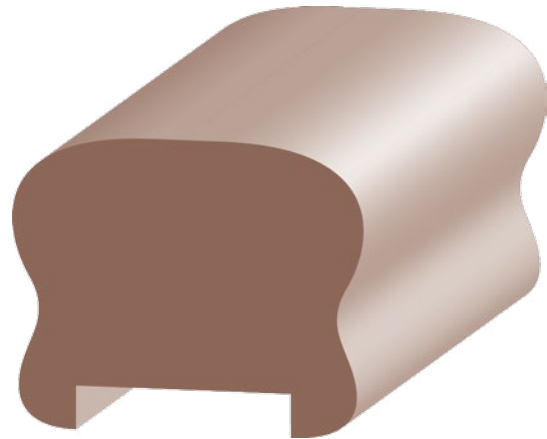

Small Handrail
w/ 1/4" x 1-1/4" Plow 1-1/2 x 1-7/8
926

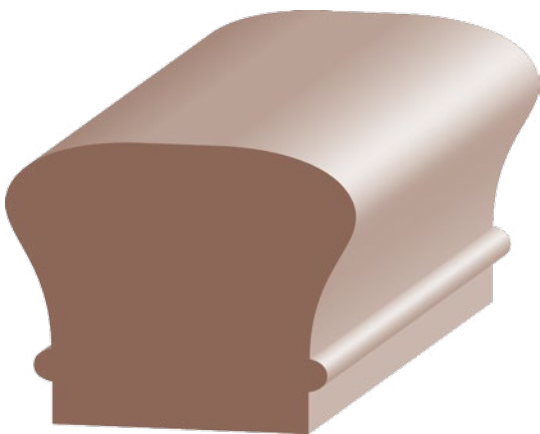

Small 6010 Handrail 1-1/2 x 1-7/8
932

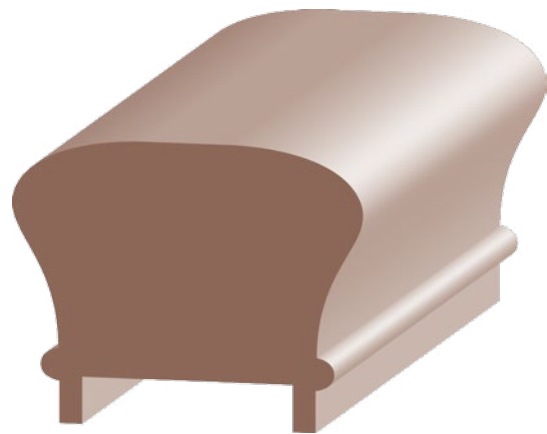

Small 6010 Handrail
w/ 1/4" x 1-1/8" Plow 1-1/2 x 1-7/8
932-P

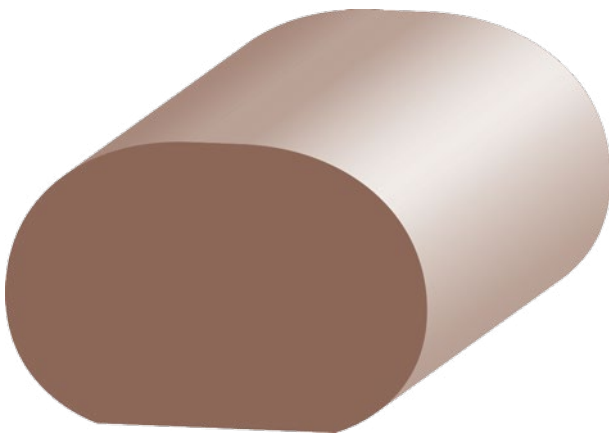

Oval Handrail 1-1/2 x 2-1/4
926

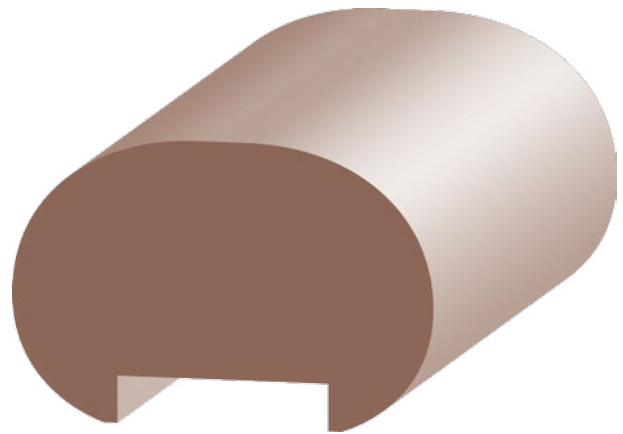

Oval Handrail
w/ 1/4" x 1-1/8" Plow 1-1/2 x 2-1/4
927P

(items are approximate scale only)



HANDRAIL

Lengths Available: 5' thru 20'

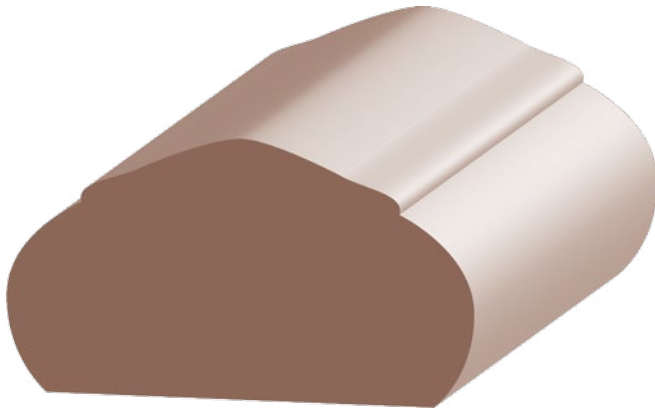

"B" Handrail 1-1/2 x 2-1/2
928

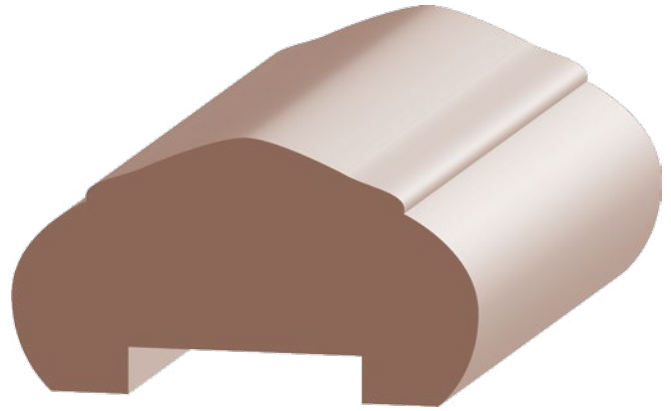

"B" Handrail 1-1/2 x 2-1/2
w/ 1/4" x 1-1/4" Plow
928P

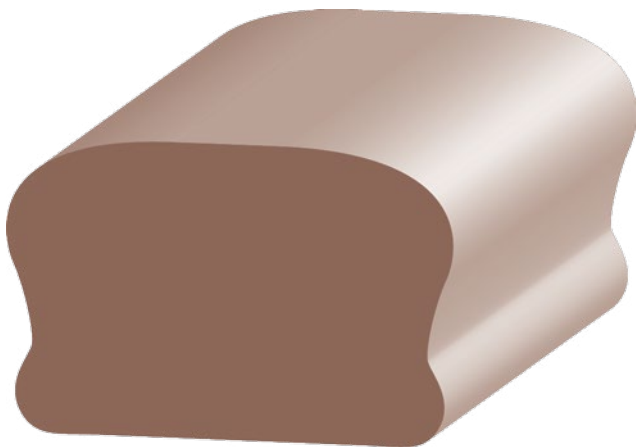

Standard Handrail 1-1/2 x 2-1/2
925

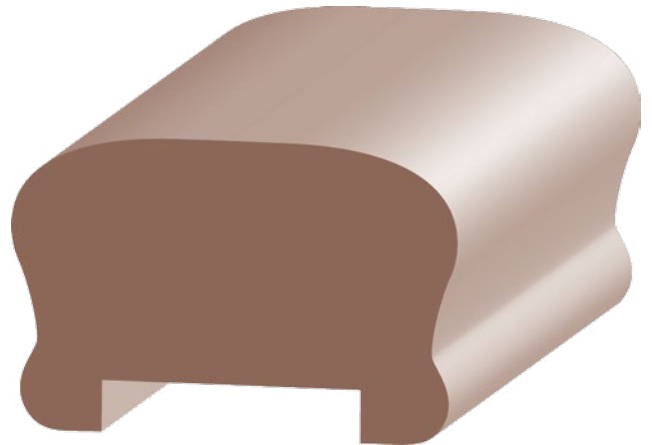

Standard Handrail 1-1/2 x 2-1/2
w/ 1/4" x 1-1/4" Plow
925P

INTERIOR S4S BOARDS

Lengths Available: 5' thru 20'



S4S (Unprimed)

715VG	3/4 x 3-1/2
750VG	3/4 x 5-1/2
751VG	3/4 x 7-1/4
752VG	3/4 x 9-1/4 (tx10)
753VG	3/4 x 11-1/4



VG FIR EXTERIOR MOLD

Lengths Available: 6' thru 20'

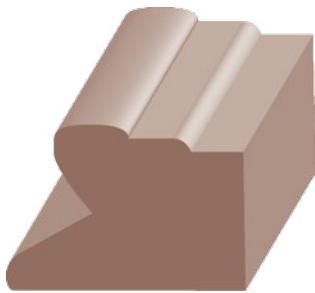

Stucco Mold 7/8 x 1-1/4
953VG VG Fir

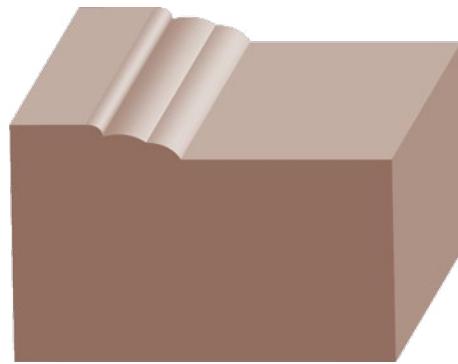

180 Eastern Brick Mold 1-1/4 x 2
612AVG

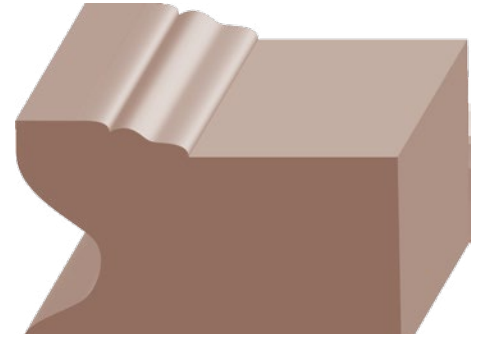

180 Eastern Brick Mold w/ Stucco Key 1-1/4 x 2
612BVG

QUARTER & FULL ROUNDS

Lengths Available: 6' thru 20'

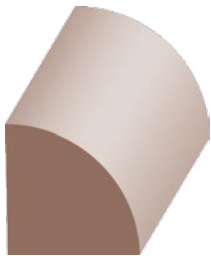

Quarter Round
504VG 11/16 x 11/16

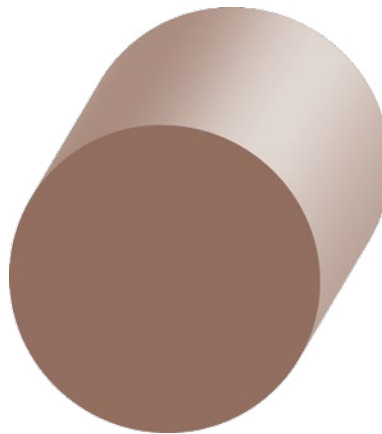

Full Round

806	1/2	803	1-3/8
800	3/4	804	1-5/8
801	1	805	1-7/8
802	1-1/4		

DOOR JAMBS & FRAMES

Interior Door Jamb

Kerfing for bullnose is available on all jamb sizes and species. Custom size odd wall widths available upon request.



Specifications:

11/16" Thick
6/8 = 81" Below Dado
8/0 = 97" Below Dado

- Lineal = 17'
- Dado depth = 3/8"
- Heads cut 3/4 over opening
- 5 pair per bundle

SIZE	SPECIES	6/8	8/0	RANDOM LINEAL
3-9/16	VG Fir	3916FI6	3916FI8	3916FIL
4-9/16	VG Fir	4916FI6	4916FI8	4916FIL
4-11/16	VG Fir	434FI6	434FI8	434FIL
5-1/4	VG Fir	514FI6	514FI8	514FIL
7-1/4	VG Fir	714FI6	714FI8	714FIL
11-1/4	VG Fir	1114FI6	1114FI8	1114FIL

DOOR JAMBS & FRAMES

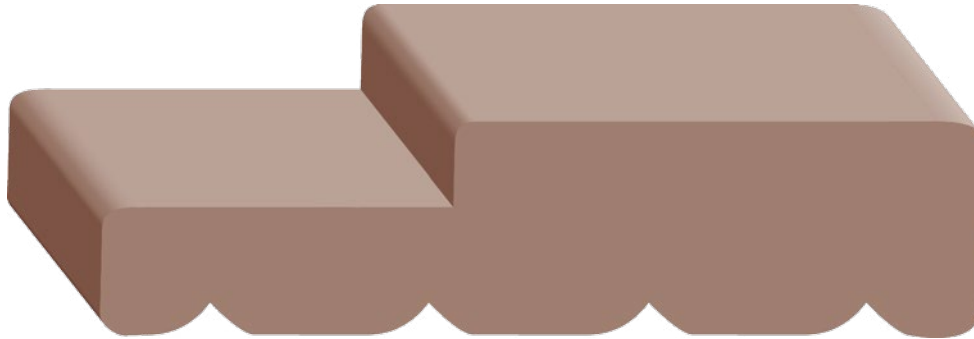

Standard Exterior Door Frame for 1-3/4" Doors

No kerf | With 1/2" x 1-13/16" Door Rab't

Specifications:

1-3/4" doors only
 6/8 = 82-1/2" Below Dado
 8/0 = 98-1/2" Below Dado

- No screen rab't
- Single end dado (except on lineal)
- 3 pairs per bundle
- Kerfing for Bullnose is available
- Custom widths available

SIZE	SPECIES	6/8	8/0	RANDOM LINEAL
4-1/8	Fir	418F6	418F8	418FL
4-1/2	Fir	412F6	412F8	412FL
4-3/4	Fir	434FE6	434FE8	434FEL
5-1/4	Fir	514FE6	514FE8	514FEL
	Veneer VG Fir	—	—	514FELSV
6-1/8	Fir	618F6	618F8	618FL
7-1/4	Fir	714FE6	714FE8	714FEL

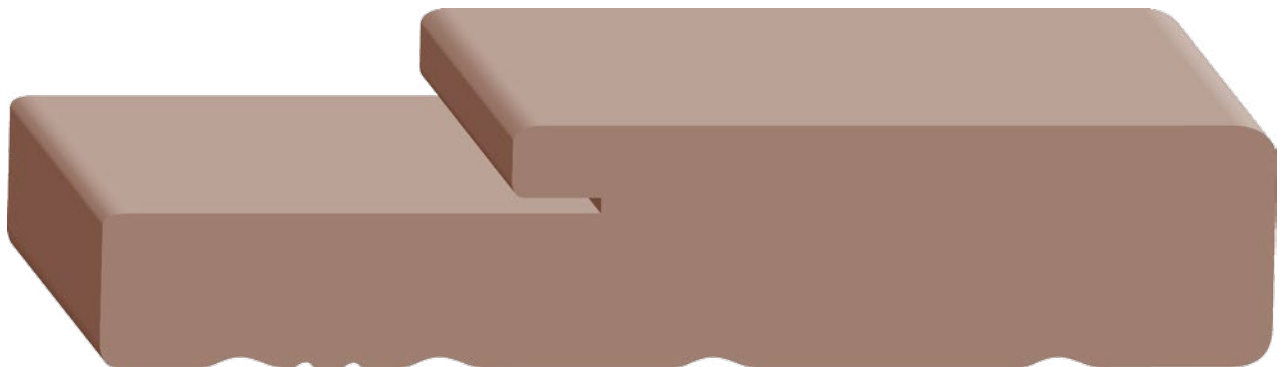

SIZE	SPECIES	6/8	8/0	RANDOM LINEAL
4-1/8	Fir	418WF6	418WF8	418WFL
4-5/8	Fir	458WF6	458WF8	458WFL
	Veneer VG Fir	—	458WF8SV	—
5-1/4	Fir	514WF6	514WF8	514WFL
	VG Fir	514WF6-VG	514WF8-VG	—
	Veneer VG Fir	—	514WF8SV	514WFLSV
6-1/8	Fir	618WF6	618WF8	618WFL
6-9/16	VG Fir	6916WF6-VG	6916WF8-VG	—
6-5/8	Fir	658WF6	—	—
	Veneer VG Fir	—	658WF8SV	—
7-1/4	Fir	714WF6	714WF8	714WFL
	VG Fir	—	714WF8-VG	—
	Veneer VG Fir	714WF6SV	714WF8SV	—

Kerfed Exterior Door Frame for 1-3/4" Doors

for 1/2" x 2-1/8" Door Rab't

Specifications:

1-3/4" doors only
 Jamb Thickness = 1-1/4"
 6/8 = 82-1/2" Below Dado
 8/0 = 98-1/2" Below Dado

- No screen rab't
- Single end dado (except on lineal)
- 3 pairs per bundle
- Kerfing for Bullnose is available
- Custom widths available



REDWOOD EXTERIOR MOLD

Lengths Available: 6' thru 20'

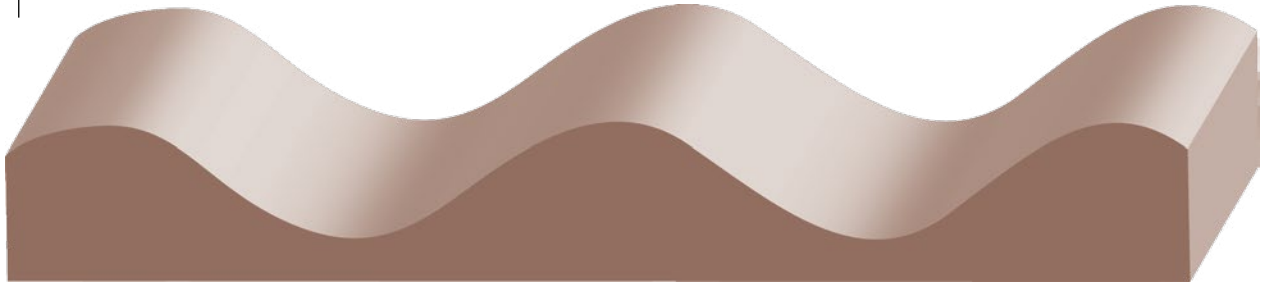

Corrugated Wiggly Mold

[Lengths Available: 8' only]

3/4 x 1-5/8

828

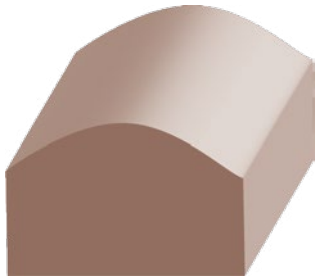

Crest

[Lengths Available: 8' only]

3/4 x 1-1/16

829

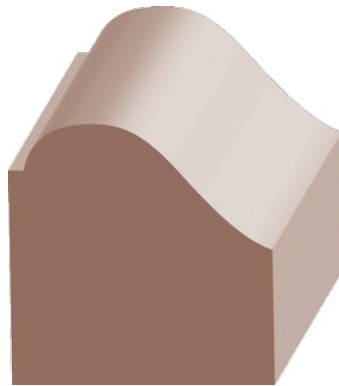

Brick Mold

1-3/8 x 1-3/8

824

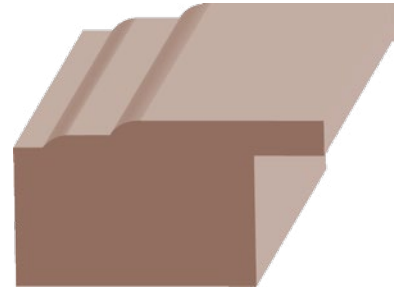

Siding

7/8 x 1-5/8

825

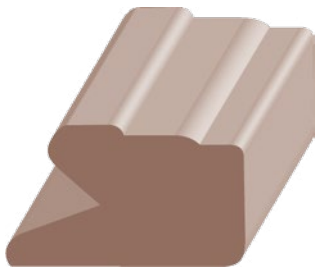

Large Stucco Mold

3/4 x 1-1/4

826

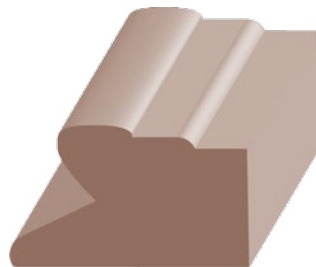

Stucco Mold

3/4 x 1-1/4

953AR

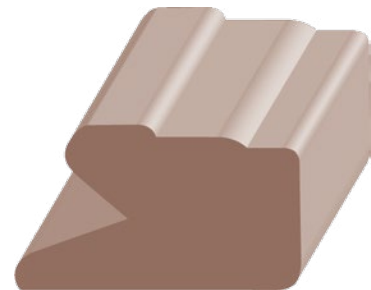

Large Stucco Mold

7/8 x 1-1/2

826A

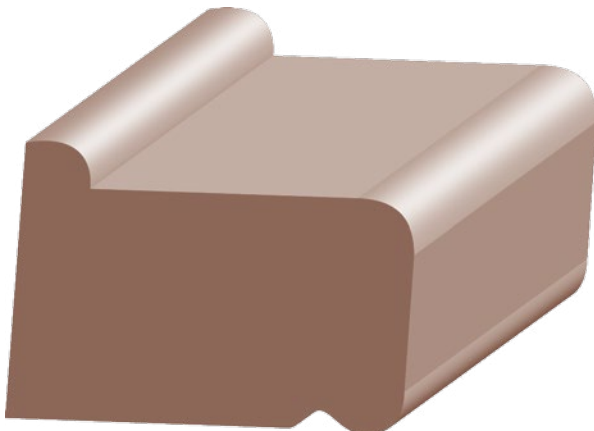

Water Table w/ Lip

1-3/8 x 2

827W



Water Table w/o Lip

1-7/16 x 2

827

(items are approximate scale only)

REDWOOD SILL

Lengths Available: 6' thru 20'



Redwood Sill 1-3/8 x 7-1/4
8RS



Redwood Sill (Reversible)
8RS 1-3/8 x 7-1/4
10RS 1-3/8 x 9-1/4

REDWOOD LATTICE

Lengths Available: 6' thru 20'



Redwood Lattice

820	1/4 x 1-1/4
821	1/4 x 1-5/8
822	1/4 x 2-1/2
823	1/4 x 3-1/2
830	1/4 x 5-1/2



IDEAS

Bodyguard & Protected Trimboard

Protected Trimboard



Inside

Base Cap.....	195
Bead & Nose Coving.....	195
Brick Mold.....	197
Casing.....	195
Cove.....	196
Crown.....	196
Exterior Molds.....	197
Extra Shutterboard.....	201
Miratec Treated Trim.....	202
Outside Corner Guard.....	195
S4S.....	200
Siding.....	199
Sill.....	198
Stucco Mold.....	197
T&G Wainscot.....	197
Water Table.....	198



Bodyguard & Protected Trimboard

Protected Trimboard



Sustainable – Bodyguard wood products come from the well-managed pine plantation forests in clean, green New Zealand.



Protected – The unique pressure treatment achieves total “active penetration” protection of the wood. The addition of waxes and resins boosts its water protection properties. The active ingredients used in this treatment process (known as Light Organic Solvent-borne Preservatives (LOSP’s) do not dissolve in water and will not be removed through leaching.



Environmentally Friendly and Safe – The Bodyguard preservative system is based on carbon based biocides and is registered in the United States of America by the EPA. As Bodyguard is real wood and contains no hazardous additives it is safe to work with, just follow normal workplace safety practices for handling wood products.



Defect Free – Bodyguard is a natural wood product manufactured from kiln - dried timber. All defects such as knots and resin pockets are removed prior to finger-jointing.



Termite Resistant – One of the active protective ingredients in Bodyguard is Permethrin, a food-crop protection product, effective against all known species of termite.



California Fire Approval – Bodyguard has had Siding & T&G profiles successfully tested by Western Fire Center Inc., to California State Fire Marshall Regulations.



Easy To Use – No special tools, cutting equipment or fixing methods are required with Bodyguard.



Paint-Ready – The machined finish of Bodyguard is enhanced by a two-coat alkyd primer system and comes with a performance warranty. A good-quality acrylic paint system applied to the manufacturer’s specification will finish the appearance and protection of Bodyguard perfectly.



Suitable For Use Inside and Outside – Bodyguard is safe for interior and exterior above ground use. We recommend application of finishing coats as soon as practicable after installation. Make sure your Bodyguard product is dry before painting.



Non-Corrosive – As the protection system’s (LOSP’s) do not contain any corrosive heavy metals and will not cause corrosion to nails and other fastening systems. Durable fasteners are recommended as good building practice for exterior applications.



30 Year Warranty – A 30-year limited warranty is provided on all Bodyguard products against termite attack, rot or fungal decay.

TRIMBOARD

MOULDING

SIDING

(items are approximate scale only)



BODYGUARD DECORATIVE MOULDING

Lengths Available: 6' thru 16'

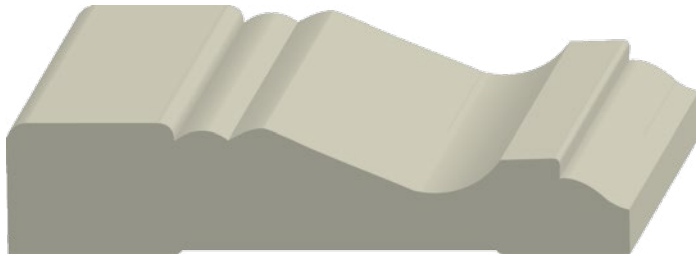

Carolina Casing 11/16 x 3-1/4
388 Bodyguard

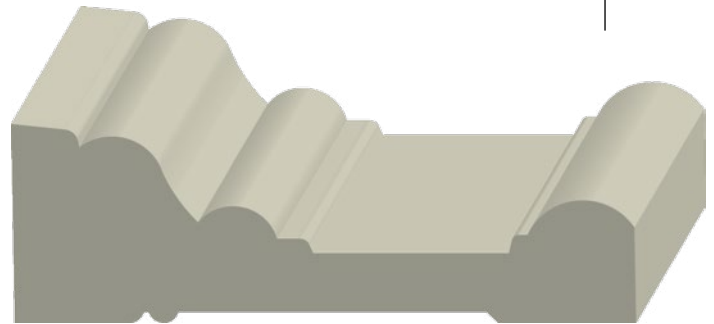

Howe Casing 1-1/16 x 3-1/4
387 Bodyguard



Architrave 1-13/16 x 4-1/4
1400 Bodyguard

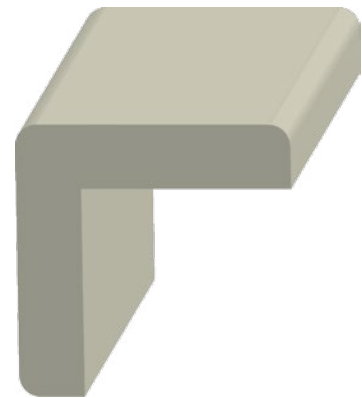

Outside Corner 1-3/8 x 1-3/8
604 Bodyguard

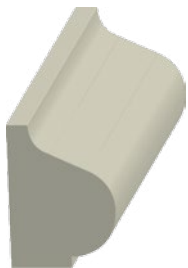

Base Cap 1/2 x 3/4
224 Bodyguard

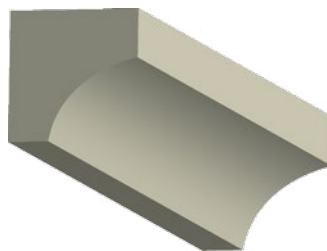

Cove 11/16 x 11/16
606 Bodyguard

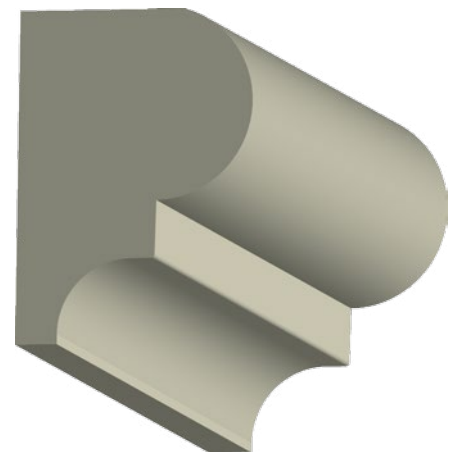

Bead & Nose Coving 1/4 x 1-3/4
024 Bodyguard



Quarter Round 11/16 x 11/16
614 Bodyguard



BODYGUARD CROWN & GUTTER MOLD

Lengths Available: 6' thru 16'

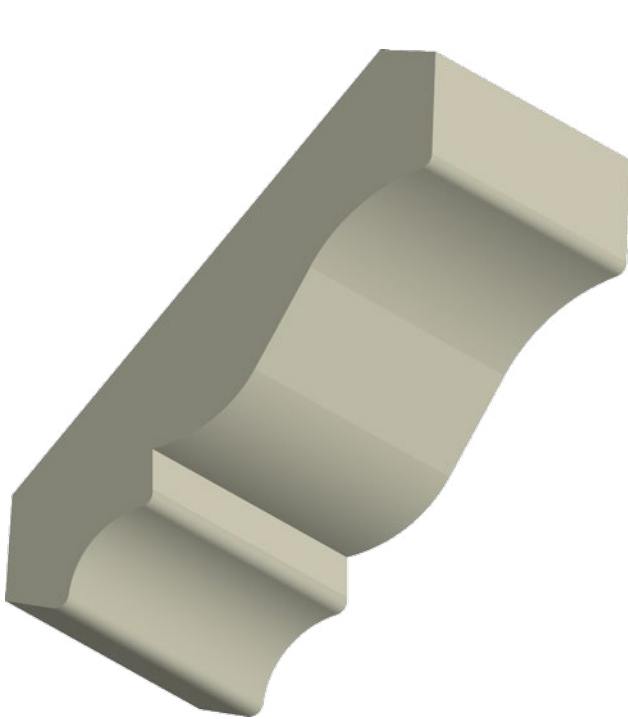

Colonial Crown $5/8 \times 3-5/8$
286 Bodyguard

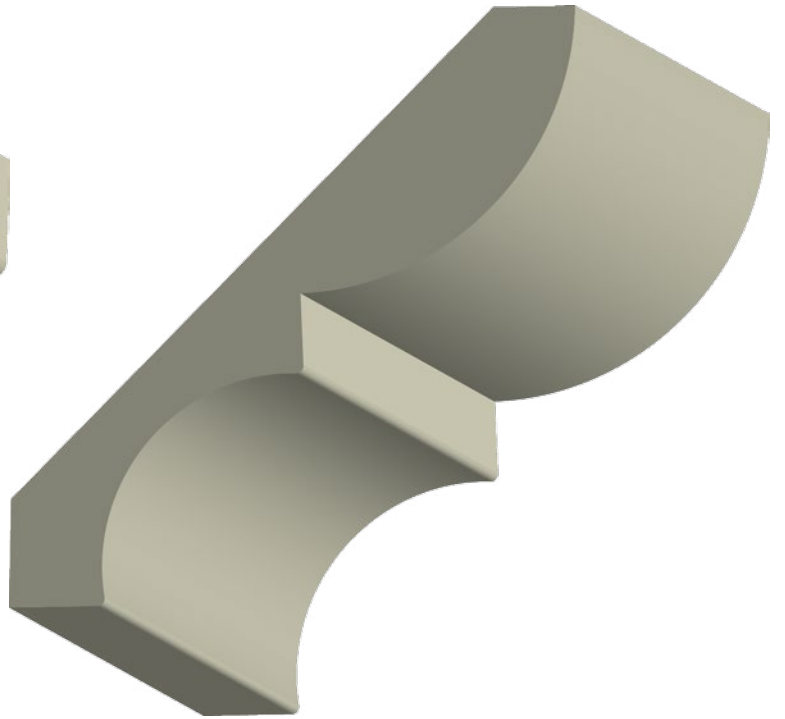

Bed Cove $3/4 \times 4-5/16$
639 Bodyguard

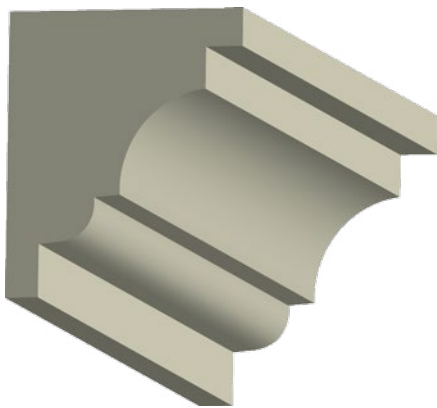

Pediment Crown $1-1/4 \times 1-1/2$
607 Bodyguard

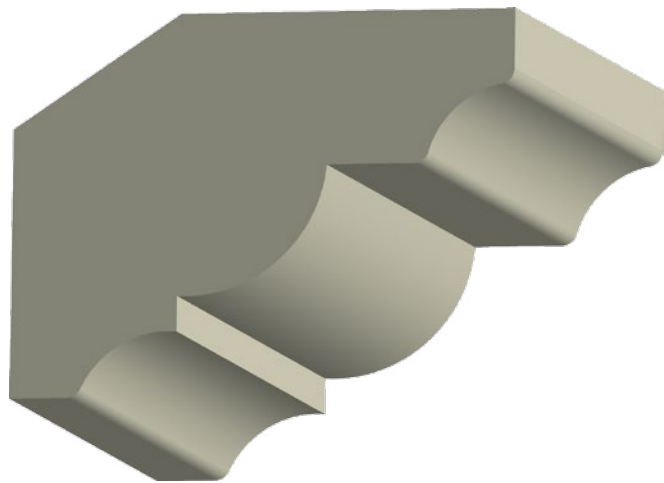

Gutter Mold $1-3/8 \times 3-5/16$
638 Bodyguard

(items are approximate scale only)



BODYGUARD EXTERIOR MOLD / T&G WAINSCOT

Lengths Available: 6' thru 16'



Shingle Mold 11/16 x 1-5/8
616 Bodyguard

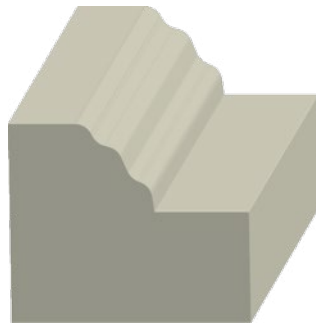

Brick Mold [Lengths Available: 17'] 1-1/4 x 1-1/2
619 Bodyguard

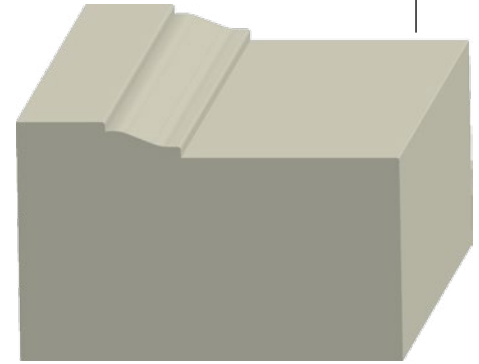

Brick Mold [Lengths Available: 17'] 1-1/4 x 2
381 Bodyguard

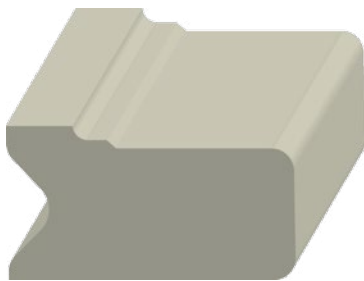

Stucco Mold 13/16 x 1-1/2
618 Bodyguard

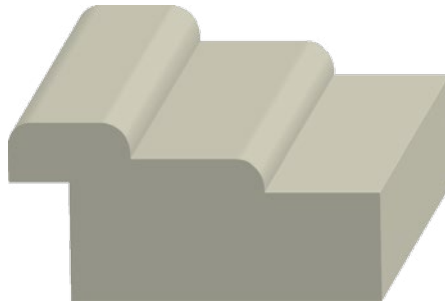

Step Stucco Mold 15/16 x 1-15/16
627 Bodyguard

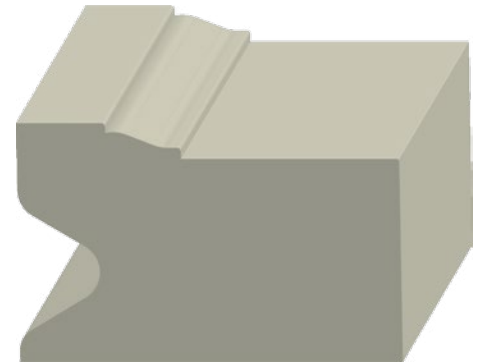

Protected Stucco Mold [Lengths Available: 17'] 1-1/4 x 2
381K Bodyguard

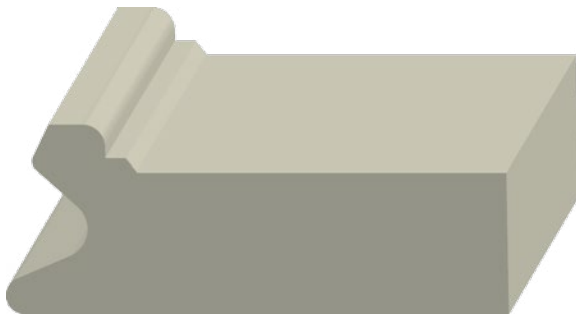

Stucco Mold 1 x 2-5/8
629 Bodyguard



Beaded T&G Wainscot 5/8 x 4
801BG Bodyguard



Beaded T&G Wainscot 1 x 6
802BG Bodyguard



BODYGUARD WATER TABLE & SILL

Lengths Available: 6' thru 16'

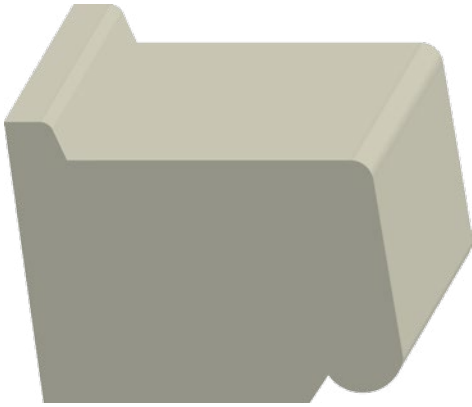

Water Table 1-7/16 x 2-1/16
630 Bodyguard



Water Table 1-7/16 x 3-1/4
634 Bodyguard

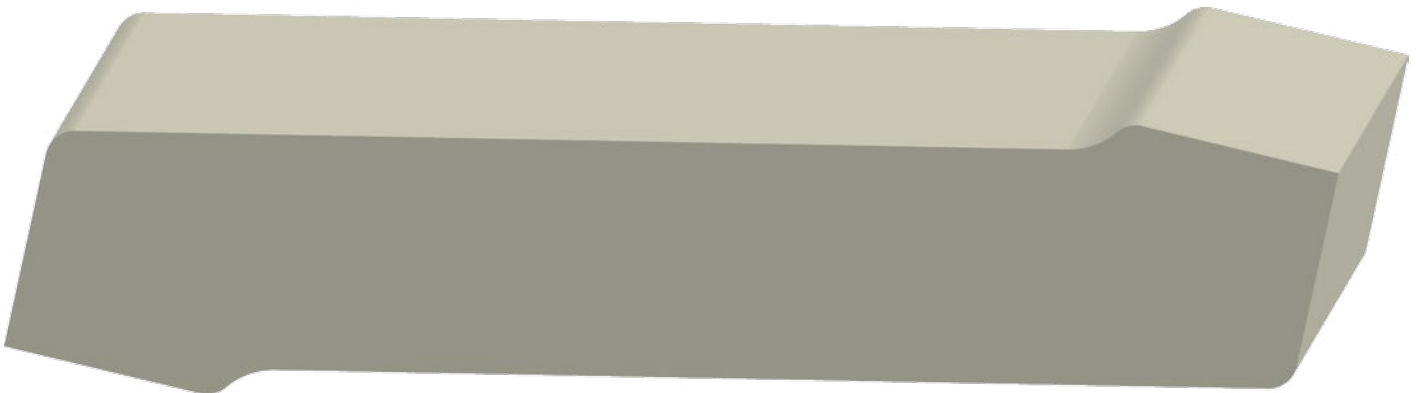

Reversible Sill
[Lengths Available: 17'] 2 x 8
640 Bodyguard



Detailed Sill *[Lengths Available: 17']* 2 x 8
642 Bodyguard

(items are approximate scale only)



BODYGUARD SIDING

Lengths Available: 6' thru 16'

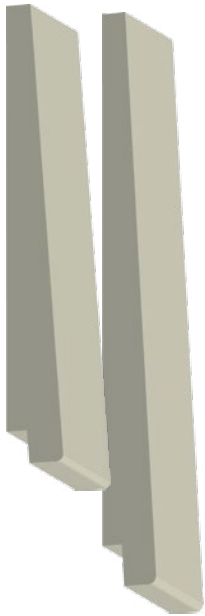

Rab't Smooth Face Siding
R/S Back Siding

371 3/4x6
372 3/4x8

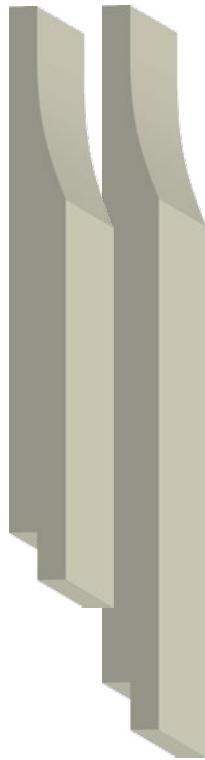

Cove Siding

771 1x8 [Available in 16' only]
772 1x10

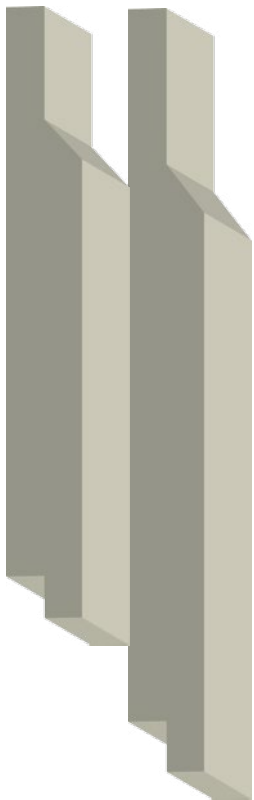

Bevel Channel Siding

774 1x8
773 1x10



V-Rustic Siding

793 1x6
794 1x8
795 1x10

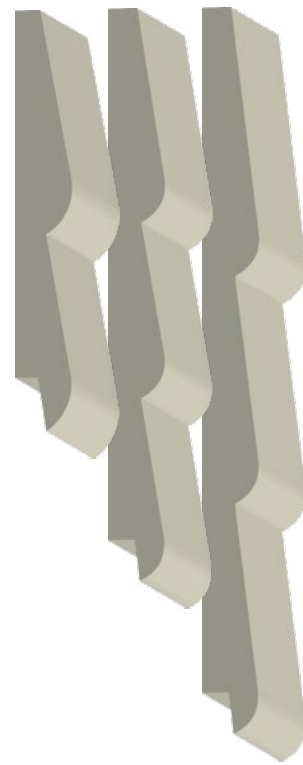

Lap Siding

430 1x6
432 1x8
433 1x10



BODYGUARD TRIMBOARD

Lengths Available: 16' & 20'



All Bodyguard products are FSC® Certified and warrantied for 30 years. QR code for more info:



Bodyguard® Protected S1S2E Trimboards

Interior/Exterior Primed FJ Pine

EL&EL NUMBER	BODYGUARD NUMBER	SIZE
1X2S1S	710	3/4 x 1-1/2
1X3S1S	711	3/4 x 2-1/2
1X4S1S	712	3/4 x 3-1/2
1X6S1S	714	3/4 x 5-1/2
1X8S1S	716	3/4 x 7-1/4
1X10S1S	718	3/4 x 9-1/4
1X12S1S	720	3/4 x 11-1/4
5/4X4S1S	723*	1-1/16 x 3-1/2
5/4X6S1S	724*	1-1/16 x 5-1/2
5/4X8S1S	725	1-1/16 x 7-1/4
2X2S1S	722	1-7/16 x 1-1/2
2X4S1S	713	1-7/16 x 3-1/2
2X6S1S	715	1-7/16 x 5-1/2
2X8S1S	717	1-7/16 x 7-1/4
2X10S1S	719	1-7/16 x 9-1/8
2X12S1S	721	1-7/16 x 11-1/8

YOUR CHOICE:

4 Reversible S1S, 4 1-Side Rough Sewn & 4 1-Side Smooth

* Available in 16' only

(items are approximate scale only)



EXTIRA TREATED SHUTTER BOARD

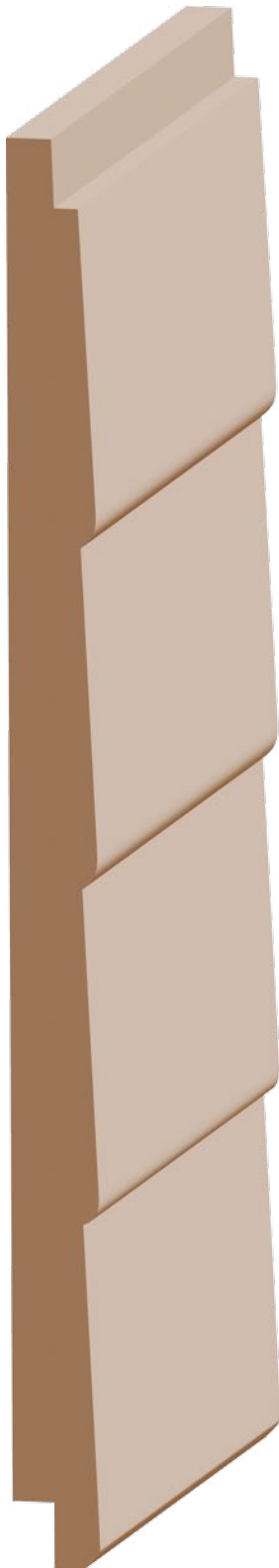

- Extira Composite Louvered Shutter Board is a great accent complementing the Exterior of your home.
- Shutter Board Panels are routed from a solid piece of composite.
- Resists moisture, rot, and termites
- Can be used for any non-structural paint-grade application, including exterior millwork, door and window parts, signage, garage doors; and architectural components.
- Extira panels also work well in high moisture interior applications such as bathrooms, medical installations, laboratories, countertop underlayment, and casework

Extira Shutter Board 1/2" X 7-5/8" X 8'
1X8EXT Extira



MIRATEC TREATED EXTERIOR COMPOSITE TRIM

Length Available: 16' only

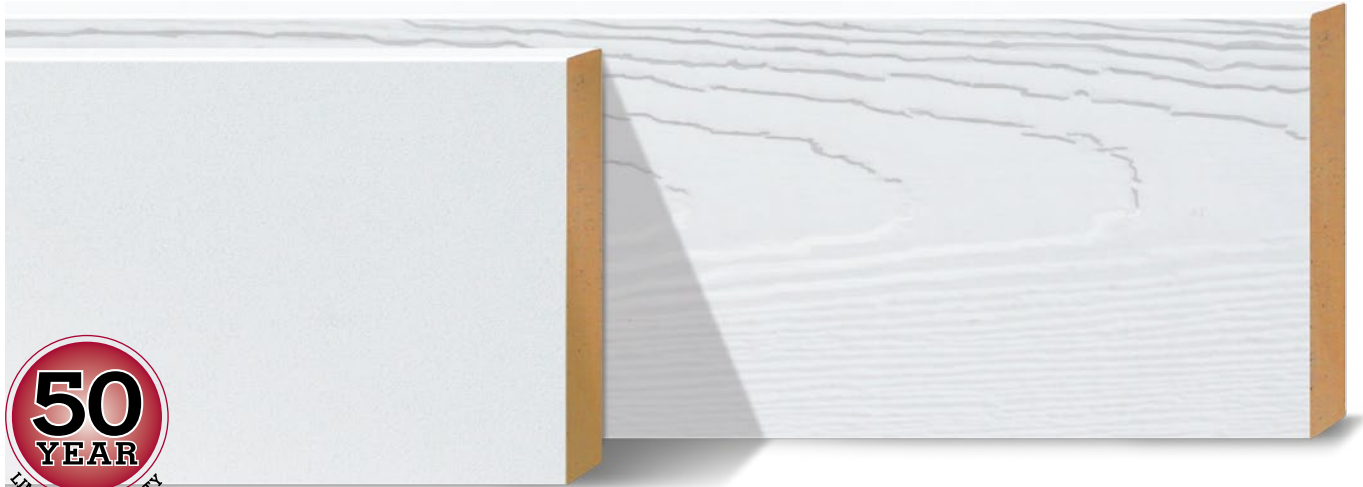

Miratec Treated Exterior Composite Trim

Part #	Nominal Size	Actual Size	Length
5/8X3MT	5/8 x 3"	5/8" x 2-5/8"	16'
5/8X4MT	5/8 x 4"	5/8" x 3-1/2"	16'
5/8X6MT	5/8 x 6"	5/8" x 5-1/2"	16'
5/8X8MT	5/8 x 8"	5/8" x 7-1/4"	16'
5/8X10MT	5/8 x 10"	5/8" x 9-1/4"	16'
5/8X12MT	5/8 x 12"	5/8" x 11-1/4"	16'
4/4X3MT	4/4 x 3"	3/4" x 2-3/4"	16'
4/4X4MT	4/4 x 4"	3/4" x 3-1/2"	16'
4/4X6MT	4/4 x 6"	3/4" x 5-1/2"	16'
4/4X8MT	4/4 x 8"	3/4" x 7-1/4"	16'
4/4X10MT	4/4 x 10"	3/4" x 9-1/4"	16'
4/4X12MT	4/4 x 12"	3/4" x 11-1/4"	16'
5/4X3MT	5/4 x 3"	1" x 2-3/4"	16'
5/4X4MT	5/4 x 4"	1" x 3-1/2"	16'
5/4X6MT	5/4 x 6"	1" x 5-1/2"	16'
5/4X8MT	5/4 x 8"	1" x 7-1/4"	16'
5/4X10MT	5/4 x 10"	1" x 9-1/4"	16'
5/4X12MT	5/4 x 12"	1" x 11-1/4"	16'

- Resists moisture, rot and termites
- Reversible with a clear, cedar wood grain texture on one side and a smooth surface on the other
- Handles like wood: easy to machine, cut, and nail.
- Won't check, split, or crack
- TEC™ patented process makes MiraTEC a solid board that has uniform properties throughout
- Primed with an ultra-low VOC primer containing a mildewcide

A LITTLE PIECE OF HISTORY

Our company was founded in 1967 by Mr. Lindy and Mr. Lynch (hence the name L & L). Unfortunately, another company already had the L & L name, so over a few good laughs, Mr. Lindy and Mr. Lynch figured they could “beat the system” by adding an ‘E’ in front of each ‘L.’ The name EL & EL was born. Within a few months, Robert Ward joined EL & EL and eventually purchased the company from Mr. Lindy and Mr. Lynch. Today, the family of Mr. Ward remains the current owner and operator of EL & EL Wood Products Corporation. Robert didn’t just build a company, he created one big happy family. Now you’re part of the story too.

Thank you for your interest in EL & EL Wood Products

Since 1967, it has been our pleasure to support you in your endeavor to help contractors, builders, and homeowners bring their amazing projects to life. We at EL & EL are committed to innovative thinking and processes that deliver a comprehensive product offering, backed by the best people in the industry. Guaranteed.

Please visit our website ELandELWoodProducts.com to find one of our many dealers near you.



EL & EL Wood Products

Millwork that creates distinction.™

ELandELWoodProducts.com