

# "SAND-SET" COBBLESTONE PAVERS

#CSP-66

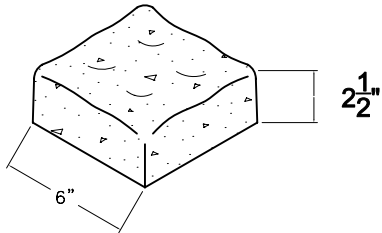

#CSP-612

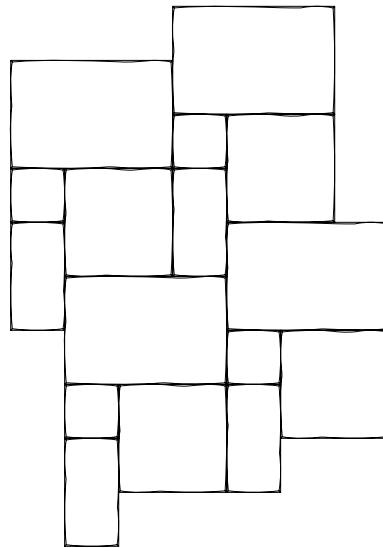
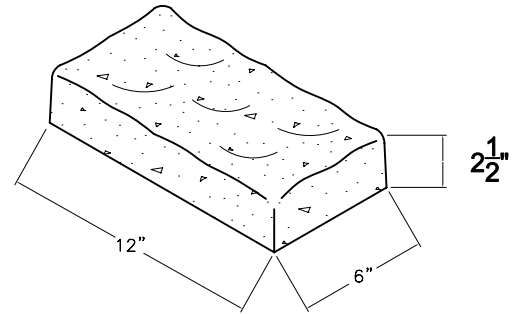

STANDARD PATTERN \*

#CSP-1212

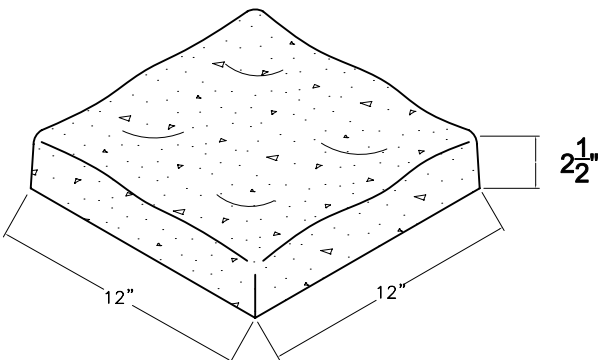

#CSP-1218

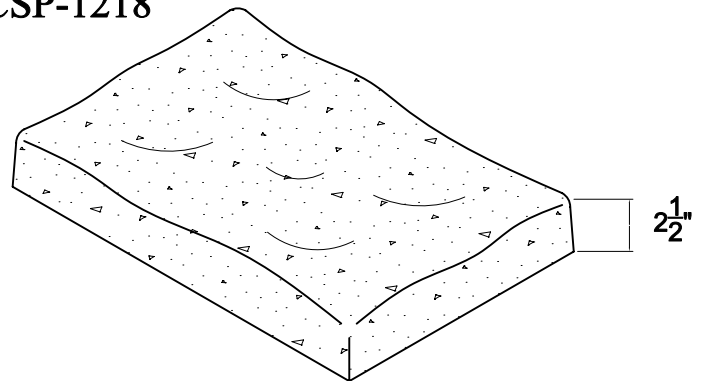

AVAILABLE IN THREE DISTINCTIVE COLOR BLENDS:  
DESERT BROWN (COLORS P-1, P-3, P-5, P-7)  
EUROPEAN GRAY (COLORS P-9, P-11, P-13, P-3)  
RED ROCKS (COLORS P-5, P-15, P-17, P-19)  
\*CUSTOM COLORS AND PATTERNS AVAILABLE UPON REQUEST  
RECOMMENDED FOR DRIVEWAY AND PARKING AREAS  
COLOR VARIATIONS AND VARIEGATION ARE INHERENT IN THIS PRODUCT

# SAND SET PAVERS

#SSP-99

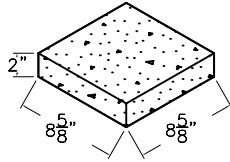

#SSP-1212

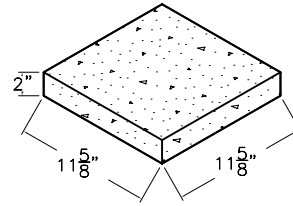

#SSP-918

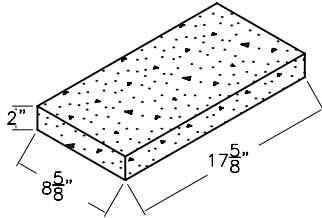

#SSP-1224

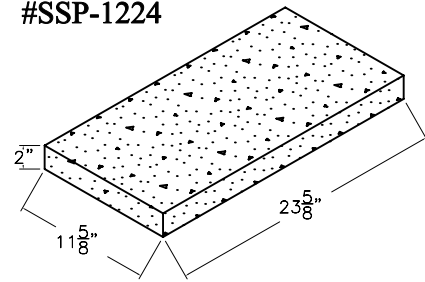

#SSP-1818

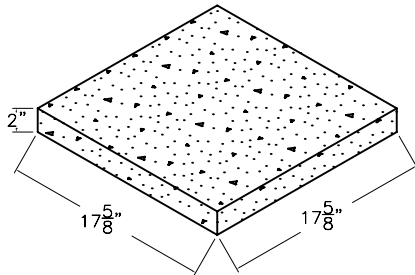

#SSP-2424

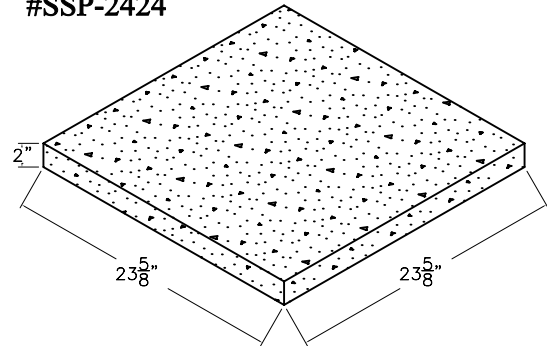

#SSP-1827

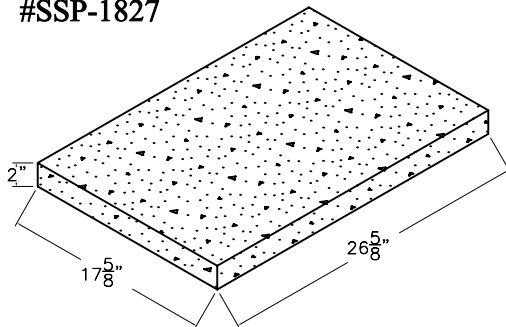

(SEE DECK TILE PATTERNS)  
NOT RECOMMENDED FOR DRIVEWAYS AND PARKING AREAS

# STEPPING STONES

#SS-1818

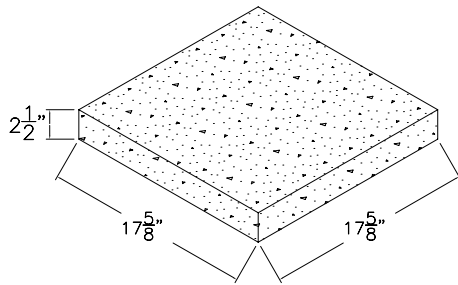

#SS-2424

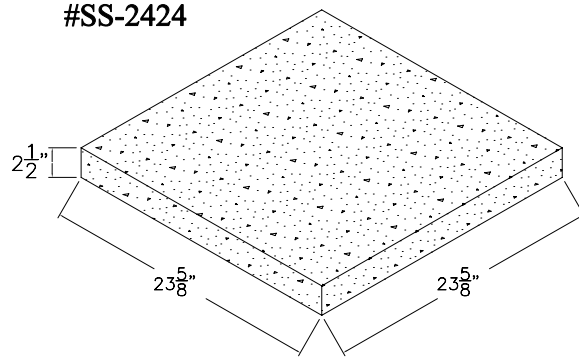

#SS-1827

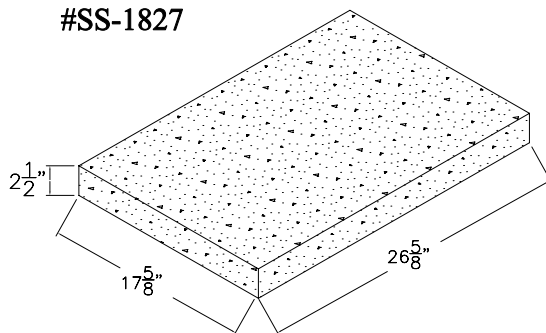

NOT RECOMMENDED FOR DRIVEWAYS AND PARKING AREAS

# PRACTICAL PAVERS

**DC-1414  
POOL COPING**

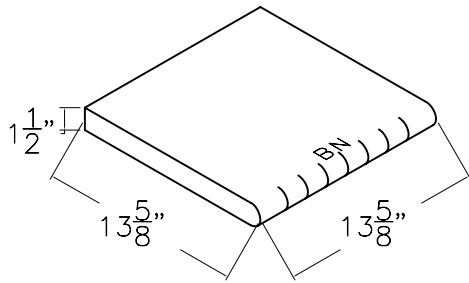

**EF-414  
EDGE FACING**

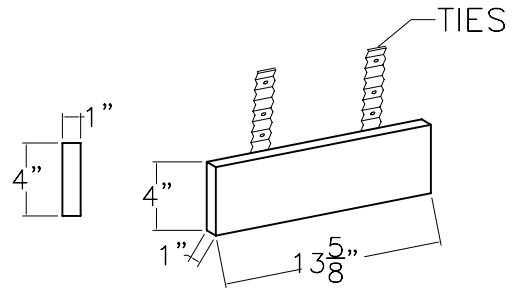

**DT-1414  
PAVER**

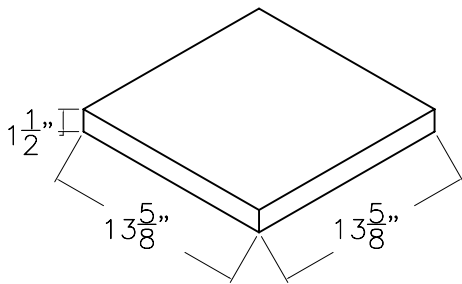

**DT-714  
PAVER**

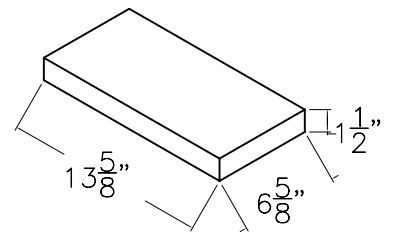

**DT-77  
PAVER**

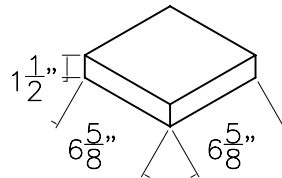

AVAILABLE IN FOUR DISTINCTIVE COLORS:  
P-3 SAND, P-5 SUNSET, P-7 CARMEL, AND P-19 TERRA

# PRACTICAL PAVERS

## VARIOUS INSTALLATION CONFIGURATIONS

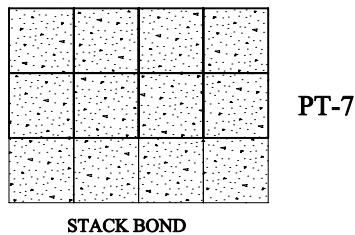
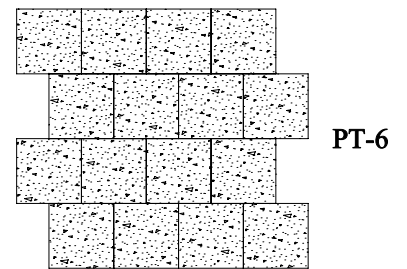
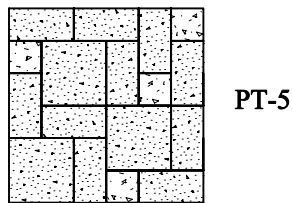
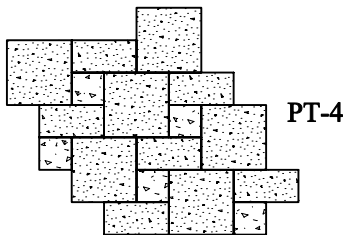
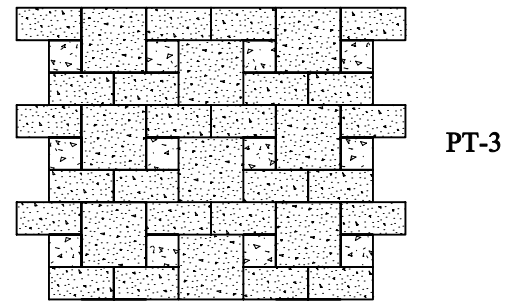
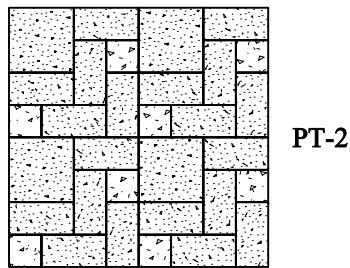
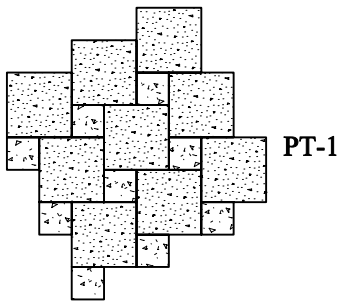

RUNNING BOND

STACK BOND

