

ADandD P/N PL-AB7

Mounting for Keyence LJ-V7200

Mounts with included (4) S.H.C.S. - M4-0.7mm X 8mm 18-8SS

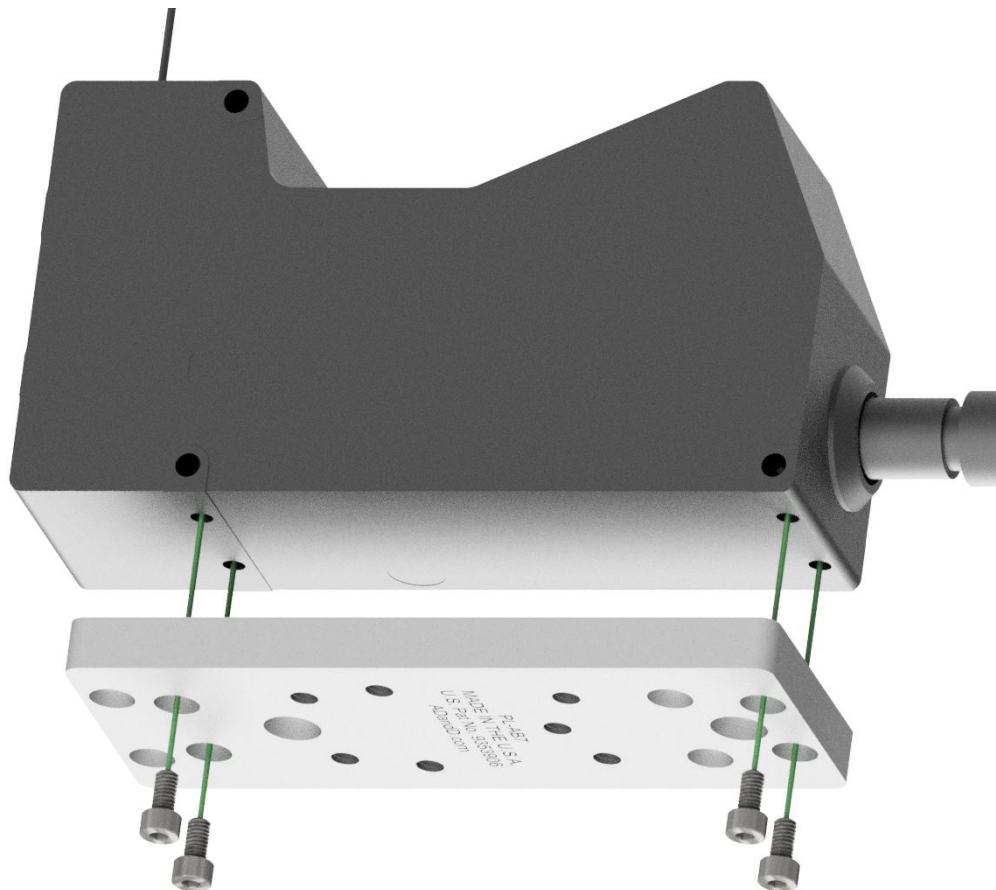

Sample Setup Application

