

FLEETWOOD

ARCHERY



America's Finest!

1968

NEW! TWIST FREE LIMBS
26 LAMINATIONS



NEW! TWIST FREE LIMBS
26 LAMINATIONS

FLEET HUNTER-60

EXOTIC HARDWOODS

America's finest hunting bow . . . high speed cast . . . positive action maneuverable. Limbs are of multiple laminations of Canadian Maple. Hand finished for beauty and durability. Backed with 3-M Scotch-ply fibre-glas.

No. 3011

60" Length
Draw Weights:
35-65# @28"

List **\$59⁹⁵**

Available in 5# Increments

Durable flannel bow case provided.

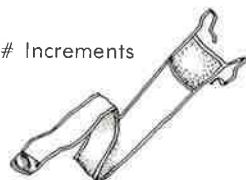

All Fleetwood bows are supplied with Dacron bow strings and Nylon servings.

FLEET HUNTER-54

EXOTIC HARDWOODS

A 54" hunting bow which handles well in blind, tree or heavy brush. 3-M Scotch-ply fibre-glas bonded together with Canadian Hard Maple...a quality, power-packed high performance bow.

No. 3016

54" Length
Draw Weights:
35-55# @28"

List **\$54⁹⁵**

Available in 5# Increments

FLEET HUNTER-54 STRATO-RISER

No. 3016-S

54" Length
Draw Weights:
35-55# @28"

List **\$49⁹⁵**

Available in 5# Increments

Durable flannel bow case provided.

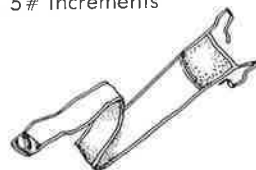

Strato-Bloc Handle
Full center-shot window.
Pistol grip with thumb rest.

Full Recurve

Full Recurve

Arrow Rest Included

Full center-shot window.
Pistol grip with thumb rest.

NEW! TWIST FREE LIMBS
26 LAMINATIONS



NEW! TWIST FREE LIMBS
26 LAMINATIONS

FLEET RANGER

EXOTIC HARDWOODS

A versatile bow for every phase of archery . . . Target, Field, or Hunting . . . a smooth working recurve that will out-perform most expensive bows. Limbs of multiple laminations of Canadian Maple. Moisture-proof finishes insure lasting beauty and protection. 3-M Scotch-ply fibre-glas facing.

No. 3010

64" Length
Draw Weights:
30-55# @28"

List **\$54⁹⁵**

Available in 5# Increments

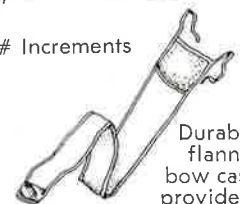

Durable flannel bow case provided.

Full Recurve

Recurve

FLEET LANE

EXOTIC HARDWOODS

A perfect bow for any archer . . . regardless of experience or interest. Limbs of multiple laminations of Canadian Maple . . . bonded with 3-M Scotch-ply fibre-glas . . . moisture-proof finish . . . designed for accuracy and quality. Ideal for indoor lanes, schools, camps, and every member of the family.

No. 3009

62" Length
Draw Weights:
25-50# @28"

List **\$39⁹⁵**

Available in 5# Increments

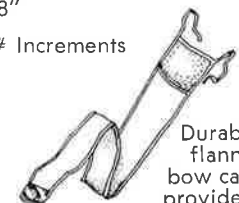

Durable flannel bow case provided.

Arrow Rest Included

Arrow Rest Included

NEW! TWIST FREE LIMBS
22 LAMINATIONS



NEW! TWIST FREE LIMBS
22 LAMINATIONS

FLEET SCOUT

A quality Strato-Riser bow of multiple laminations of Canadian Hard Maple and 3-M Scotch-ply fibre-glas . . . moisture proof finish. Ideal for schools, camps, and archery organizations as well as for those who wish to learn archery. Suitable for target, field, and some types of small game hunting.

No. 3008
60" Length
Draw Weights:
20-45# @28"

List \$**34⁹⁵**

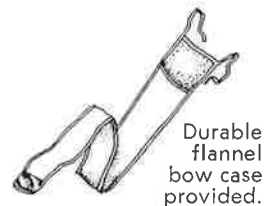

FLEET TWIN

STRATO-BLOCK LAMINATIONS

New twin-window design with Arrow Rests . . . great for schools, camps, lanes and archery clubs . . . eliminates need for special bows for lefthanded archers. Multiple laminations of Canadian Hard Maple . . . 3-M Scotch-ply fibre-glas . . . moisture proof finish for durable lasting beauty.

No. 3017
60" Length
Draw Weights:
20-45# @28"

List \$**34⁹⁵**

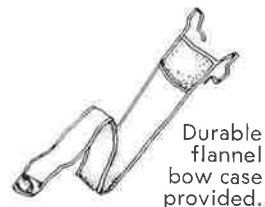

For either right or left handed archers.

Strato-Bloc Handle
Twin Window
Semi Pistol grip.



FLEETWOOD FIBRE-GLAS BOWS

All Fleetwood Fibre-Glas Bows are constructed with 240,000 parallel glass filaments as a reinforcement agent, to give greater tensile and flexural strength. Ideal for Camps, Schools and Archery beginners.

BOW SPECIFICATIONS

Packed 12 per carton

Model No.	Name	Bow Length	Pull Wt. Recommended	List Price
2001	Cub (hemp string)	42"	10-15#	\$3.95
2002	Bobcat	48"	15-20#	\$4.95
2003	Wildcat	48"	20-25#	\$5.95
2004	Fleet-Teen	54"	20-25#, 25-30#, 30-35#	\$7.95
*2005	Fleet-Queen	54"	30-35#, 35-40#	\$8.95
2006	Fleet-Wing	60"	25-30#, 30-35#	\$9.95
*2007	Fleet-King	54"	40-45#, 45-50#	\$9.95
*2008	Fleet-Master	60"	35-40#, 40-45#, 45-50#, 50-55#	\$12.95

SPECIFY BOW WEIGHT
In 5# Increments . . .

* Window Type Bows

Fleetwood Fibre-Glas Bows are supplied with Type "B" Dacron Bowstrings with Nylon Servings.

Here are finest-quality solid fibre-glas bows on the market. They have been tested in a 600 hour salt spray test, have withstood 300 hours in a Weatherometer and have survived gruelling tests of stress and flexibility. *The beautiful high-gloss finish is chip-proof, stain-proof, and moisture-proof.*

All Fleetwood Fibre-Glas Bows are beautifully finished in *Epoxy*.

WINDOW TYPE BOW VINYL HANDLE . . . provides sure grip and ample space for arrow rest for center shot.

FOR RIGHT OR LEFT HAND SHOOTERS

All bows are hand nocked to insure proper string alignment.



FLEETWOOD ARCHERY SETS

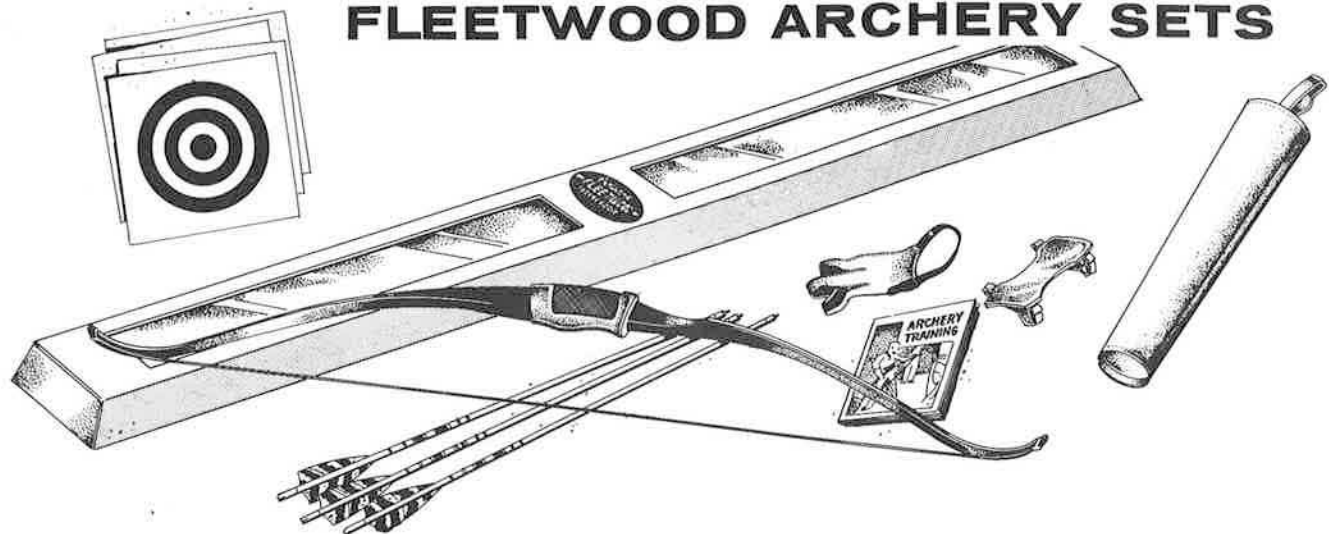

ARCHERY SETS
STANDARD WAREHOUSE PACK
6 Per Shipping Carton

No. 6004 WILDCAT ARCHERY SET—(7-12 years of age)

- 1 48" Fibre-Glas Bow—20#/25#
- Dacron String
- 3 Cedar Arrows
- 1 Quiver
- 1 Armguard
- 1 Finger Tab
- Target Face and Booklet

Only \$9.95

No. 6001 CUB ARCHERY SET—(Up to 8 years of age)

- 1 42" Fibre-Glas Bow—10#/15#
- Hemp String
- 3 Cedar Arrows
- 1 Quiver
- Target Face and Booklet

Only \$5.95

No. 6005 FLEET-TEEN ARCHERY SET—(10-16 years of age)

- 1 54" Fibre-Glas Bow—30/35#
- Dacron String
- 3 Cedar Target Arrows
- 1 Armguard
- 1 Finger Tab
- 1 Belt Quiver
- Target Face and Booklet

Only \$12.95

No. 6003 BOBCAT ARCHERY SET—(Up to 10 years of age)

- 1 48" Fibre-Glas Bow—15#/20#
- Dacron String
- 3 Cedar Arrows
- 1 Quiver
- 1 Finger Tab
- 1 Armguard
- Target Face and Booklet

Only \$8.95

No. 6006 FLEET-LANE ARCHERY SET

- 1 60" Fibre-Glas Bow—30/35#
- Dacron String
- 3 Cedar Target Arrows
- 1 Armguard
- 1 Finger Tab
- 1 Belt Quiver
- Target Face and Booklet

Only \$13.95

NEW! Go Bow Fishing... AN EXCITING SPORT

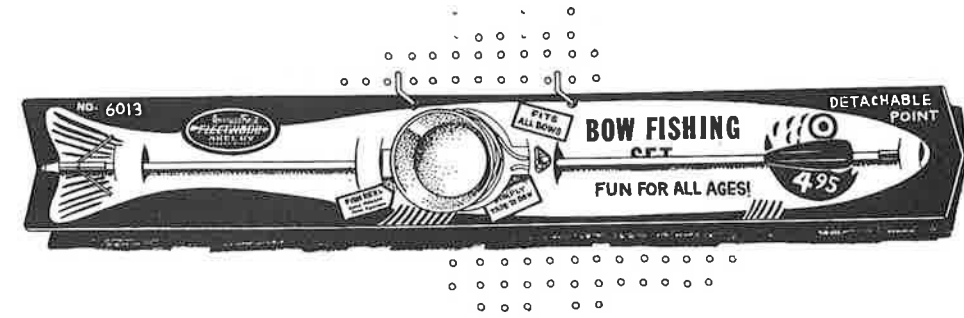

FLEETWOOD BOWFISHING SET

No. 5005 Reel and No. 1177 or No. 1180 Arrow packaged for Peg Board

- No. 6013-G (with Fibre-Glas Arrow) **Only \$4.95**
- No. 6013-A (with Aluminum Arrow) **Only \$4.95**

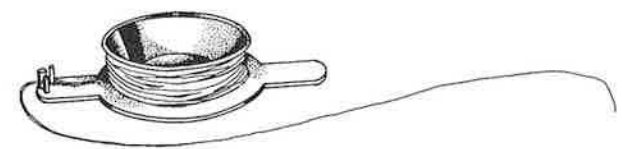

BOW-REEL with 50' of 70# test Nylon Line

No. 5005 **Each \$1.95**

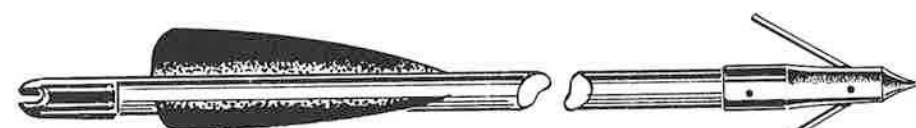

SOLID FIBRE-GLAS FISH ARROW

32" length . . . two prong fish point . . . plastic fletching

- No. 1177 **Each \$3.00**
- No. 1177X (same without point) **Each \$2.00**
- No. 1179 (Point only) **Each \$1.00**

NEW!



RUST-PROOF ALUMINUM FISH ARROW

32" length . . . two prong fish point . . . plastic fletching

No. 1180 **Each \$3.00**

FLEETWOOD ARCHERY SETS

No. 6007 FLEET-WING FIELD & HUNTING SET

- 1 54" Fibre-Glas Bow—40#/45#
- Dacron String
- 3 Cedar Field Arrows—40/45# Spine
- 1 Armguard
- 1 Finger Tab
- 1 Belt Quiver
- Target Face and Booklet

Only \$14.95

No. 6009 FLEET-RANGER TARGET & FIELD SET

- 1 60" Fibre-Glas Bow—45/50#
- Dacron String
- 3 Cedar Field Arrows—45/50# Spine
- 1 Armguard
- 1 Glove
- 1 Quiver
- Target Face and Booklet

Only \$19.95



DACRON BOW STRINGS

Fabricated in our plant from Dupont *Dacron thread . . . loops and centers served with Nylon. Gives the best value on the market.

BOW STRING ACCESSORIES

FLEET BOW STRING SERVER

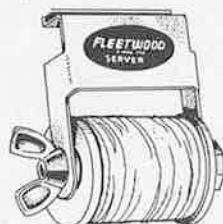

No more slow turn-at-a-time hand turning. Just rotate the string and serving is complete in one minute or less . . . full spool of thread for 60 or more servings. Factory wound.

5200 Fleet Bow String Server only \$1.25

5204 Extra spool Nylon serving thread \$.75

5201 Fleet Server with Nylon thread \$2.00

1 ounce, (Black, White, Green, Red, Blue, Yellow)



*DACRON THREAD

Bonded—36# per strand

5125 Type B—Dacron 4 oz. spool \$2.50

5124 Type B—Dacron 4 oz. pre-waxed \$2.50

5205 Type B—Dacron 1# pre-waxed \$10.00



BOW STRING WAX

5128-1 dozen \$3.00 (packed 12 per display)

PRE-STRETCHED *DACRON DOUBLE LOOP

7001 10 strand (up to 35#) 4 sizes only (Actual Length) 44", 50", 56", 62" (Small Loop for Glass Bows) \$1.00

7002 12 strand (35# to 60#) Large Loop* \$1.25

7003 14 strand (over 60#) Large Loop* \$1.50

* for Laminated Bows

Actual string lengths available: (No. 7002 and No. 7003) from 44" to 68" in 1" increments. Bow string is about 3" to 4" shorter than bow length. Be sure to specify actual string length when ordering.

PRE-STRETCHED *DACRON SINGLE LOOP

7090 10 strand (up to 40#) Small Loop for Glass Bows \$1.00

Three single loop string lengths available: 4'-4 1/2', 4 1/2'-5', 5'-5 1/2'

HEMP SINGLE LOOP BOW STRINGS

7088 Made of finest Italian hemp, individually packaged. 6' long single loop to serve any size bow . . . recommended for children's light weight bows up to 20#. List Price \$.35

* Dupont Trademark for Polyester Fiber

To use single loop strings, make timber hitch knot as shown. Secure with tape or rubber band.



PORT ORFORD CEDAR PRACTICE ARROWS

No. 1000

NEW 100 PRACTICE ARROW ASSORTMENT

No.	Quantity	Arrow Type	Size	Suggested List each
No. 1002	25	Target Arrows	26"	.35
No. 1003	25	Target Arrows	28"	.40
No. 1007	25	Field Arrows	28"	.50
No. 1008	25	Field Arrows	28"	.65

Takes only 1/2 Sq. Ft. of Display Space List Price \$47.50
Shipping Weight 8#

PRACTICE TARGET ARROW ASSORTMENTS

Factory No.	Unit Pack	Die-cut Feathers	Asst. Crests	List Price
1002-6	6 doz.	2 1/2"	2 color	\$24.00
1002-3	3 doz.	2 1/2"	2 color	\$12.00
1003-6	6 doz.	3 1/4"	2 color	\$28.80
1003-3	3 doz.	3 1/4"	2 color	\$14.40
* 1003-1	1 doz.	3 1/4"	2 color	\$ 4.80
1004-6	6 doz.	4"	3 color	\$36.00
1004-3	3 doz.	4"	3 color	\$18.00
* 1004-1	1 doz.	4"	3 color	\$ 6.00

28" length or assortments of 26" and 28" units are available.

Weights 1# per dozen.

PRACTICE FIELD ARROW ASSORTMENTS

Factory No.	Unit Pack	Die-cut Feathers	Asst. Crests	List Price
1007-3	3 doz.	4"	3 colors	\$18.00
* 1007-1	1 doz.	4"	3 colors	\$ 6.00
* 1008-1	1 doz.	5 1/4"	4 colors	\$ 7.80
1008-3	3 doz.	5 1/4"	4 colors	\$23.40
1008-6	6 doz.	5 1/4"	4 colors	\$45.00

Field Arrows Available in 26" and 28" lengths.

* Standard Warehouse Pack
12 dozen per shipping carton



36 Arrow Assortment

100 Arrow Assortment

BOW STRING ASSORTMENT

No. 7108

120 DACRON PRE-STRETCHED BOWSTRINGS

Packaged in Display Rack List \$150.00

Assorted as follows:

No. 7001 — 10 strand
6 each of 4 sizes (Double Loop): 44", 50", 56", 60" and single loop 4 1/2'-5'

No. 7002 — 12 strand (Double Loop)
6 each of 10 sizes: 48" to 66" in 2" increments

No. 7003 — 14 strand (Double Loop)
6 each of 5 sizes: 52", 54", 56", 58" and 60"



Other Assortments Available on Request.

PORT ORFORD CEDAR SPECIAL TARGET ARROW ASSORTMENTS

Suggested List
3 for \$1.00

No. 1002-6

- 3 dozen 26" Arrows
- 3 dozen 28" Arrows
- OR
- 6 dozen 26" Arrows
- OR
- 6 dozen 28" Arrows

Colorful Assortment Crested Arrows.
Turkey Die-cut Feathers — Target Points
6 dozen List Price \$24.00
Weight 6#

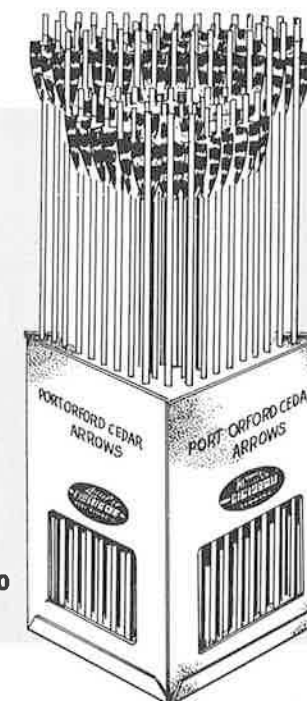

PORT ORFORD CEDAR FIELD ARROW ASSORTMENTS

Suggested List
50c Arrows

No. 1007-6

- 3 dozen 26" Arrows
- 3 dozen 28" Arrows
- OR
- 6 dozen 26" Arrows
- OR
- 6 dozen 28" Arrows

Colorful Assortment with 4" Feathers — Crested and Die-cast Field Points
6 dozen List Price \$36.00
Weight 6#



PORT ORFORD CEDAR ARROWS

DELUXE . . . Spine Matched only.

FLITE MATCHED . . . Matched in Spine and Weight.

Shafts are doweled from split stock Oregon Port Orford Cedar, properly seasoned

WEIGHTS AVAILABLE

35/40# 40/45# 45/50# 50/55# 55/60# 60/65#

TARGET ARROWS — 26"—28" or 30" Length

No.	Description	Quantity	List
1011-1	Deluxe	Doz.	\$10.80
1011-0	Deluxe	1/2 Doz.	\$ 5.60
1013-1	Flite-Matched	Doz.	\$12.00
1013-0	Flite-Matched	1/2 Doz.	\$ 6.20

FIELD ARROWS — 26"—28" or 30" Length — 5" Feathers

No.	Description	Quantity	List
1012-1	Deluxe	Doz.	\$12.00
1012-0	Deluxe	1/2 Doz.	\$ 6.20
1017-1	Flite-Matched	Doz.	\$14.40
1017-0	Flite-Matched	1/2 Doz.	\$ 7.40

HUNTING ARROWS — 26"—28" or 30" Length — 5" Feathers

No.	Description	Blade	Quantity	List
1014-1	Deluxe	2 or 3	Doz.	\$13.80
1014-0	Deluxe	2 or 3	1/2 Doz.	\$ 7.10
1018-1-2	Deluxe	2 Bear	Doz.	\$14.80
1018-0-2	Deluxe	2 Bear	1/2 Doz.	\$ 7.60
1018-1-4	Deluxe	4 Bear	Doz.	\$16.80
1018-0-4	Deluxe	4 Bear	1/2 Doz.	\$ 8.60
1020-1	Deluxe	4 Hilbre	Doz.	\$16.80
1020-0	Deluxe	4 Hilbre	1/2 Doz.	\$ 8.60
1015-1	Flite Matched	2 or 3	Doz.	\$16.80
1015-0	Flite Matched	2 or 3	1/2 Doz.	\$ 8.60
1016-1-2	Flite Matched	2 Bear	Doz.	\$19.00
1016-0-2	Flite Matched	2 Bear	1/2 Doz.	\$ 9.70
1016-1-4	Flite Matched	4 Bear	Doz.	\$21.00
1016-0-4	Flite Matched	4 Bear	1/2 Doz.	\$10.70
1019-1	Flite Matched	4 Hilbre	Doz.	\$21.00
1019-0	Flite Matched	4 Hilbre	1/2 Doz.	\$10.70

FULL LENGTH ARROWS—

No Points — 31" Long — Crested and Fletched

No.	Description	Fletch	Quantity	List
1010-1X	Flite Matched	5"	Doz.	\$12.00
1021-1X	Deluxe	5"	Doz.	\$10.00
1021-3X	Deluxe	5"	3 Doz.	\$25.00
1021-6X	Deluxe	5"	6 Doz.	\$50.00
1011-1X	Deluxe	3 1/2"	Doz.	\$ 9.00
1013-1X	Flite Matched	3 1/2"	Doz.	\$10.80

FLITE MATCHED ARROWS cut to your length. Arrows longer than 28" should be stiffened 5# per inch. Shorter than 28" decreased 5# per inch.

Example (45# Bow)

28" Arrow — 45# sft 30" Arrow — 55# sft
 29" Arrow — 50# sft 31" Arrow — 60# sft
 32" Arrow — 65# sft



Target Arrow



Field Arrow



2 Blade Hunting Arrow



3 Blade Hunting Arrow

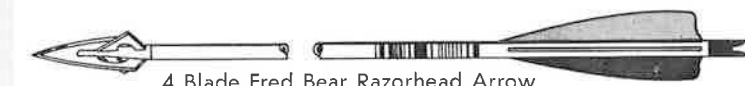

4 Blade Fred Bear Razorhead Arrow



4 Blade Super Hilbre Arrow

KING OF THE FOREST HUNTING ARROWS

Packed 48 per Dealer Display
 40-50# Spine
 Lengths 28" or 30"

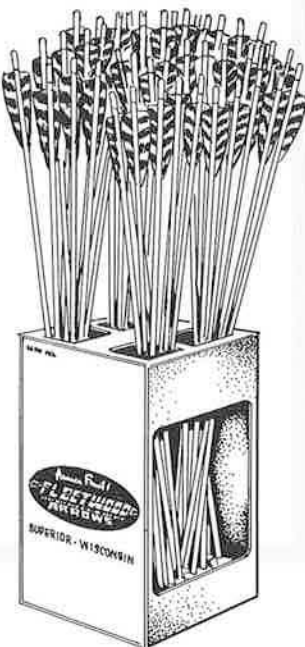

No. 1022-48
 2-Blade\$52.80 List

No. 1023-48
 3-Blade\$52.80 List

No. 1024-48
 4-Blade\$55.20 List

Standard Warehouse Pack
 12 — 1 Doz. Pack. per Carton
 24 — 1/2 Doz. Pack. per Carton



FLU-FLU ARROWS

for hunting birds and small game

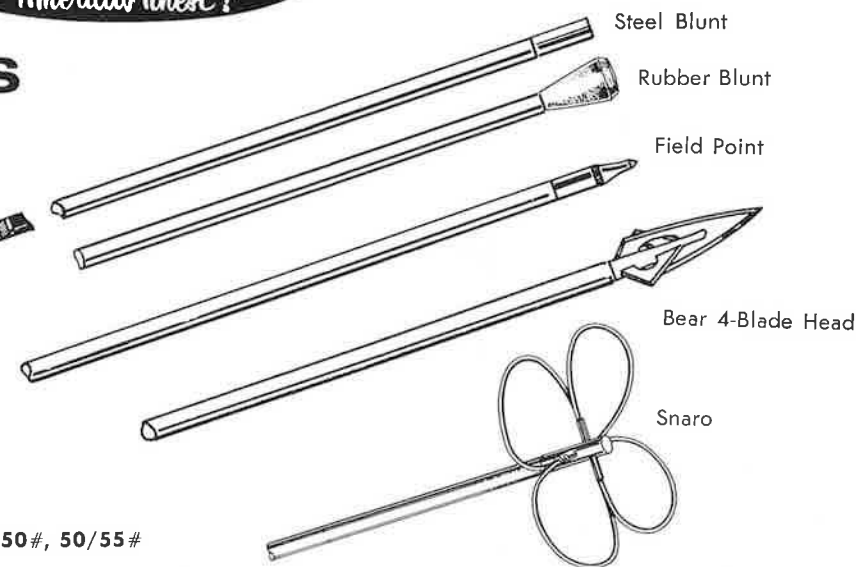
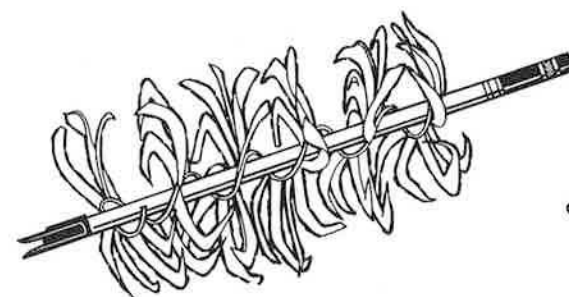

FLU-FLU ARROWS —

28" or 30" long. 35/40#, 40/45#, 45/50#, 50/55#
 Available Weights

Made of select Port Orford Cedar. Six inches of feather fletching spiraled around the shaft. Steel or Rubber Blunt points for short distance, practice or tree shot. New SNARO point of high temper spring steel wire for bird and flight shooting.

	Each	Box of 6
1089 with Steel Blunt or Field Point	\$1.50	\$ 9.00
1088 with HTM Rubber Blunt or Bludgeon	\$1.50	\$ 9.00
1095 with SNARO Wire Point	\$2.50	\$15.00
1084 with Bear Hunting Head	\$2.00	\$12.00

Packed 6 per unit
 Please specify draw length and bow weight

America's Safest Arrow . . .

WILL TRAVEL ONLY SHORT DISTANCES.

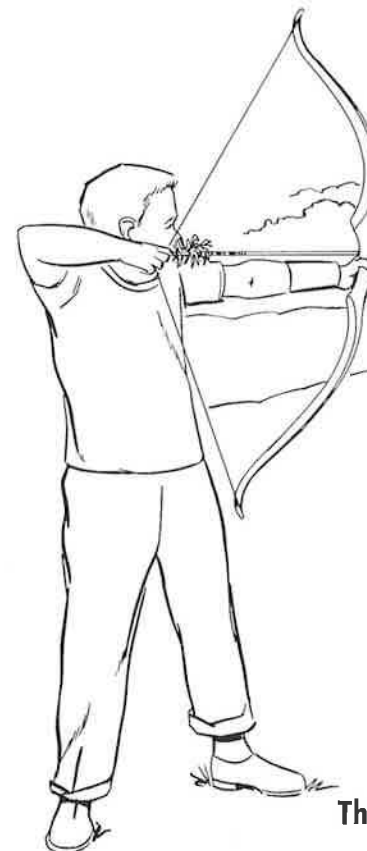

New

FLU-FLU PRACTICE ARROWS FOR KIDS

For close-range target practice
 Packed 24 to a box
 Target points 28" length

\$.50 Ea.

No. 1087-2 Display\$12.00
 The safest practice target arrow on the market.
 Limited flight range.

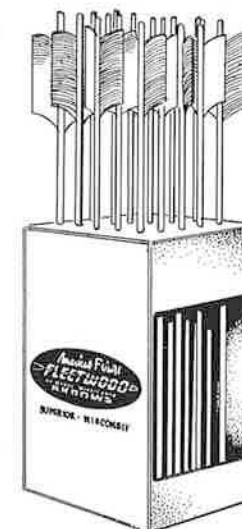



FLEET *Supreme* ALL-WEATHER ARROWS

ARROW SHAFTS — Complete with Points and Inserts

The finest tubular fibre-glas arrow shafts made . . . manufactured in our own factory . . . each shaft micrometer perfect. You can pay more, but you cannot buy better glass arrow shafts.

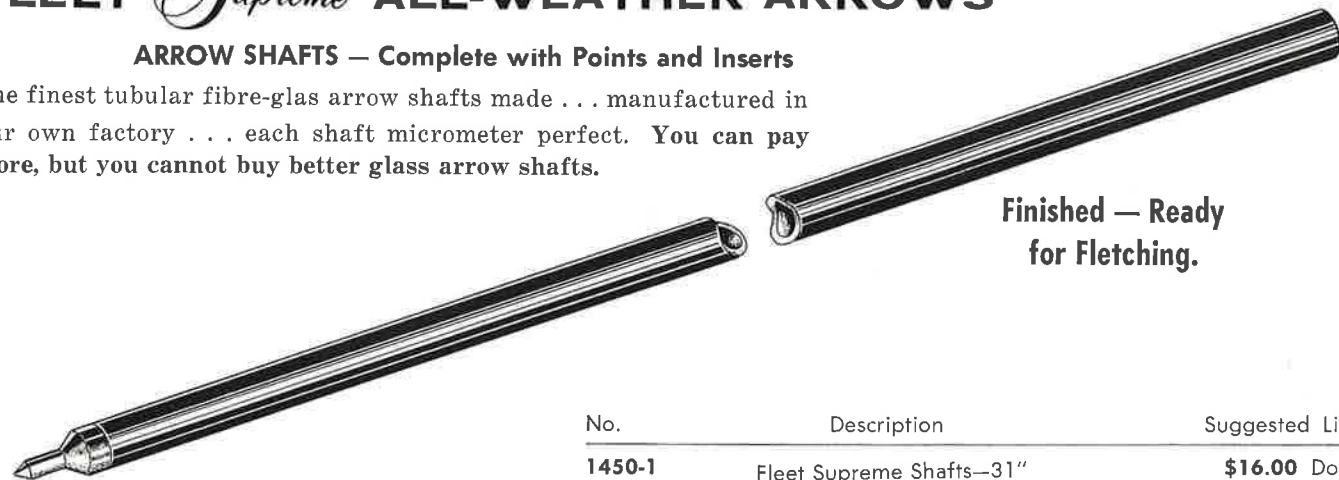

Finished — Ready for Fletching.

No.	Description	Suggested List
1450-1	Fleet Supreme Shafts—31" Nock Inserts, with Target Points or Broadhead Adapters, Loose	\$16.00 Doz.

STANDARD SHAFT LENGTHS are 31" in length for all sizes. 32" Shafts are available at an additional cost of \$1.00 per Dozen List.

NOCK INSERTS and POINTS

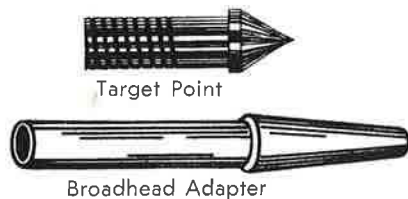

Target Point

Broadhead Adapter

One dozen insert type points with each dozen Fleet Supreme Shafts. Specify steel insert target points, or broadhead adapters for hunting or field points.

1466-1	Nock Inserts	\$1.80 Doz.
1109-1	Target Points	\$2.40 Doz.
1031-1	Broadhead Adapters	\$2.40 Doz.



EPOXY CEMENT

No. 5131 Two Tubes List \$1.35 Unit

SPECIFICATIONS:

Shaft Size	210	230	240	250	260	260-4
Nock Size	9/32	5/16	5/16	5/16	11/32	11/32

Suggested Shaft Sizes for Bow Weights and Arrow Lengths

Arrow Length	24"	26"	28"	30"	32"
Bow Weights					
25/30	X	210	210	230	240
30/35	X	210	230	240	240
35/40	210	210	230	240	250
40/45	210	230	240/250	250	260
45/50	230	240	250	260	260-4
50/55	240	250	260	260-4	260-4
55/60	240	260	270	260-4	260-4
60/65	250	260	270	260-4	260-4

FINISHING YOUR SHAFTS

1. Cut shafts to length and install points with Fleet-Fast Cement.
2. Break shaft glaze on feather area by sanding very lightly with No. 80 grit sandpaper.
3. Apply clear lacquer to sanded area of shaft.
4. Install nocks with epoxy or household cement.
5. Fletch with household cement.
6. Crest as desired.



FLEET *Supreme* ALL-WEATHER ARROWS

Fleet Supreme Fibre-Glas makes the strongest, toughest arrows on today's market, demonstrated by laboratory tests . . . color never fades . . . held within a tolerance of .005. Unaffected by moisture or temperature.

Accurate • Durable • Dependable • Rugged • Flite Matched • Light Weight

FOR TARGET — Up to 31"

The finest fibre-glas arrow on the market today. Accurately matched in spine and weight to match your bow. Insert points, (not slip-over) plastic nocks, machine spiral fletched, neatly painted with distinctive crest. State bow weight and draw length. The ideal target arrow.

No.	All Lengths	Quantity	List
3 Fletch—Points Installed			
1366-1	Doz.	\$20.00
1366-0	1/2 Doz.	\$10.20
Full Length—Points Loose			
1366-1X	Doz.	\$19.00
1366-0X	1/2 Doz.	\$9.70
4 Fletch—Points Installed			
1367-1	Doz.	\$22.00
1367-0	1/2 Doz.	\$11.20
Full Length—Points Loose			
1367-1X	Doz.	\$21.00
1367-0X	1/2 Doz.	\$10.70



FOR FIELD — Up to 31"

Our non-skip field point is especially designed to stop an arrow where it touches the ground. Fletched with 5" spiral field type feathers. Matched in spine and weight. The most practical field arrow on the market today. State bow weight and draw length.

No.	All Lengths	Quantity	List
3 Fletch			
1350-1	Doz.	\$23.00
1350-0	1/2 Doz.	\$11.70
Full Length—Points Loose			
1350-1X	Doz.	\$22.00
1350-0X	1/2 Doz.	\$10.20
4 Fletch			
1358-1	Doz.	\$24.00
1358-0	1/2 Doz.	\$12.20
Full Length—Points Loose			
1358-1X	Doz.	\$23.00
1358-0X	1/2 Doz.	\$11.70

FOR HUNTING AND FIELD — Up to 31"

Matched in spine and weight. Fletched with extra heavy ground base spiral fletching, plastic nocks, neatly crested, extremely rugged and dependable.

(A) Deerslayer 2-Blade broadhead made of spring steel to hold keen edge. Up to 30".

No.	All Lengths	Quantity	List
1383-1	Doz.	\$24.00
1383-0	1/2 Doz.	\$12.20



(A)

(B) 3-Blade broadhead. Up to 30".

1384-1	Doz.	\$24.00
1384-0	1/2 Doz.	\$12.20



(B)

(C) Bear Razorhead 4-blade. Up to 30".

1385-1-4	Doz.	\$30.00
1385-0-4	1/2 Doz.	\$15.20

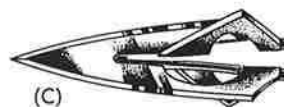

(C)

(D) "King of the Forest" 4-blade. Up to 30".

1386-1	Doz.	\$24.00
1386-0	1/2 Doz.	\$12.20



(D)

(E) Broadhead adapter installed. No point included. Up to 30".

1382-1	Doz.	\$22.00
1382-0	1/2 Doz.	\$11.20



(E)

Full Length—Adapters Loose.

1382-1X	Doz.	\$21.00
1382-0X	1/2 Doz.	\$11.70

(F) Super Hilbre

1398-1	Doz.	\$30.00
1398-0	1/2 Doz.	\$15.20

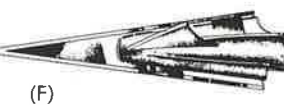

(F)

4-Fletch available at an additional cost of \$2.00 per dozen list.

NOTE: Be sure to state your draw length and bow weight. For best results use Epoxy Cement to install points, adapters and hunting heads.



EASTON ALUMINUM SHAFTS and ARROWS

SWIFT SHAFT FEATURES — Every Shaft:

- Swaged to a point and spiral ground for 11½° full diameter nock taper.
- Identified with trade name and shaft size.
- Includes a precision one piece, long shank case hardened nickel plated steel target point or aluminum broadhead adapter insert.
- Has a bright, clean, burnished surface.
- "Spinner" straight —needs no further straightening.

The SWIFT Shaft will make a perfect arrow for the beginning archer, a good practice and utility arrow for the expert, and a successful and economical arrow for the serious hunter.

24SRT-X ® 3 FLECH TARGET TYPE

No.	Description	Quantity	List
1241-1	Points installed	Doz.	\$32.00
1241-1X	Full Length — Points loose	Doz.	\$31.00
1241-0	Points installed	½ Doz.	\$16.20
1241-0X	Full Length — Points loose	½ Doz.	\$15.70

EASTON SWIFT 3 FLECH TARGET TYPE

No.	Description	Quantity	List
1246-1	Points installed	Doz.	\$28.00
1246-1X	Full Length — Points loose	Doz.	\$27.00
1246-0	Points installed	½ Doz.	\$14.20
1246-0X	Full Length — Points loose	½ Doz.	\$13.70

EASTON SWIFT 3-FLECH 4-BLADE BEAR-HEADS

No.	Description	Quantity	List
1244-1	Heads installed	Doz.	\$32.00
1244-1X	Full Length — Points loose	Doz.	\$31.00
1244-0	Points installed	½ Doz.	\$16.20
1244-0X	Full Length — Points loose	½ Doz.	\$15.70

EASTON ALUMINUM SHAFTS With Target Points Or Broadhead Adapters (Please Specify)

No.	Description	Quantity	List
1275-1	Swift Shafts with points loose	Doz.	\$22.00
1255-1	24SRT-X Shafts with points loose	Doz.	\$26.00

TARGET POINTS AND BROADHEAD ADAPTERS

No.	Description	Quantity	List
1210-1	Target Points	Doz.	\$3.80
1230-1	Broadhead Adapters	Doz.	\$2.40

EASTON ARROW CHART

Bow Weight	24"	25"	26"	27"	28"	29"	30"	31"
25 lb.		1516		1616		1716		
30 lb.	1516		1616		1716	1816		
35 lb.		1616		1716	1718 1816	1816	1818 1916	1916
40 lb.	1616	1616	1716	1718 1816	1816	1818 1916	1916	2016
45 lb.		1716	1718 1816	1816	1818 1916	1916	2016	2016
50 lb.		1718	1816	1818	1916	2016		

When ordering aluminum arrows be sure to specify type of point, arrow length and bow weight. Selection of arrows will be governed by Easton's selection chart. (Right)



MICRO-FLITE SHAFTS AND ARROWS

Micro-Flite shafts are made absolutely straight and since fiberglass is impervious to the elements and unbelievably resilient to the forces of head-on impact, they stay straight. They will not corrode, become misshapen from any cause, or crystallize and, through years of usage, will maintain all their original qualities. Critically controlled production methods provide such absolute uniformity that every shaft is the twin of every other shaft in its production run. ■ Micro-Flite shafts are made in eleven different diameters and weights starting with a Size O, which has an outside diameter of .250 inches, and increasing in increments of .010 inches up to a Size 12 shaft which measures .363 inches. See charts below.

SHAFTS with Nock Inserts, Target Points Loose

No. 1119-1 \$20.00 Doz.

SHAFTS with Nock Inserts, Broadhead Adapters Loose

No. 1120-1 \$20.00 Doz.

SHAFTS ONLY

11 sizes up to 31"

No. 1123-1 \$16.00 Doz.

TARGET POINTS

No. 1124-1 \$2.40 Doz.

BROADHEAD OR FIELD POINT ADAPTERS

No. 1125-1 \$2.40 Doz.

NOCK ADAPTER INSERTS

No. 1126-1 \$1.80 Doz.

HUNTING ARROWS 3 Fletch — Crested

No.	Description	Quantity	List
1129-1	BHA Installed No Points Included	Doz.	\$32.00
1129-1X	Full length BHA loose	Doz.	\$31.00
1130-1	2-3 Blade	Doz.	\$35.00
1128-1	4-Blade Bear	Doz.	\$37.00
1129-0	BHA Installed No Points Included	½ Doz.	\$16.50
1130-0	2-3 Blade	½ Doz.	\$18.00
1128-0	4-Blade Bear	½ Doz.	\$19.00

HUNTING AND FIELD ARROWS

Bow Weight at Draw Length	Draw Length									
	23"	24"	25"	26"	27"	28"	29"	30"	31"	
30-35	1	2	3	4	5	6	7	8	9	
35-40	2	2	3	4	5	6	7	8	9	
40-45		3	4	5	6	7	8	9	10	
45-50		4	5	6	7	8	9	10	11	
50-55		5	6	7	8	9	10	11	11	
55-60			7	8	9	10	11	11	12	
60-65			8	9	10	11	11	12	12	
65-70			9	10	11	11	12	12	12	
70-75				10	11	12	12	12	12	
75-80					11	11	12	12	12	
80-85						11	12	12	12	
85-90							12	12	12	

4-Fletch available at an additional cost of \$2.00 per dozen list

TARGET ARROWS 3 Fletch — Crested

No.	Description	Quantity	List
1127-1	Points installed	Doz.	\$32.00
1127-1X	Full Length — Points loose	Doz.	\$31.00
1127-0	Points installed	½ Doz.	\$16.50
1127-0X	Full Length — Points loose	½ Doz.	\$16.00

FIELD ARROWS 3 Fletch — Crested

No.	Quantity	List
1184-1	Doz.	\$33.50
1184-0	½ Doz.	\$17.00

TARGET ARROWS

Bow Weight at Draw Length	Draw Length									
	23"	24"	25"	26"	27"	28"	29"	30"	31"	
20-25	0	0	0	1	2	3	4	5	6	
25-30	0	0	1	2	3	4	5	6	7	
30-35	0	1	2	3	4	5	6	7	8	
35-40	1	2	3	4	5	6	7	8	9	
40-45	1	2	3	4	6	7	8	9	10	
45-50	2	3	4	5	6	7	8	9	10	
50-55		4	5	6	7	8	9	10	11	
55-60		5	6	7	8	9	10	11	11	
60-65			7	8	9	10	11	11	12	
65-70			8	9	10	10	11	12	12	
70-75				10	10	11	12	12	12	



LEATHER ACCESSORIES

Pre-Priced, packaged for Peg Board

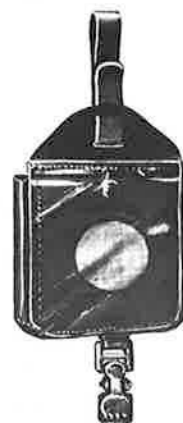

Powder Pouches



Belt Pouch



Score Card Holder



Bow String Caddy

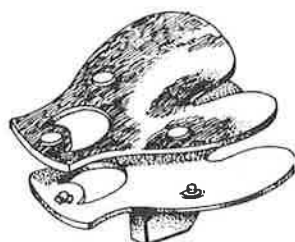

SNAP-ON KANTPINCH HAIR TAB

Hair Calf facing snaps on backing. Patented finger separator.
4039 \$2.25
 Hair Calf replacement facing
4040 \$.75

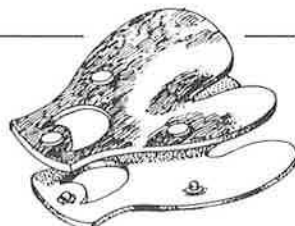

SNAP-ON HAIR TAB

4029 \$1.50
 Hair Calf replacement facing
4040 \$.75

4051 \$2.50
 Large 3 1/2 x 3 1/4 inch powder pocket with spring snap closing, 2 inch powder opening with Polyethylene flap. Score card and Pencil holder. Spring type Clip can be worn without belt. Available in 2 colors: Black or White.

4050 \$1.50
 Made of tough vinyl for lasting service. Keeps powder dry and handy. Snaps around belt — has protective cover. Easily applied by patting dispensing section. Easy to fill thru top opening.

BOW STRING CADDY
 Keeps string secure when bow is unstrung.
4046 \$1.00

SCORE CARD HOLDER
 Deluxe model with steel clip and pocket for pencil.
4044 \$1.00

POWDER POUCH

BELT POUCH

4049 Belt Pouch \$3.25
 For those archers who never have enough pocket room here is the ultimate in accessory pouches. Black or White. Size 5 1/2 inches long, 2 1/2 inches wide.

LEATHER SHOOTING TABS



4043 \$2.25
 Cowhide Finger Tab — Small or Large
4041 \$1.50
 Leather Finger Tab — Small or Large



4037 \$1.85
 Kant-Pinch Tab — Small, Medium or Large. Specify Right or Left.



4036 \$1.00
 Tab \$1.00
 For a fast, smooth release. Small, Medium or Large. Right or Left Handed. Lined with smooth leather.



4035 \$1.00
 Adjustable tab. Cordovan, lined with smooth leather. Adjustable elastic finger loop.



4030 \$1.00
 Leather guard with steel stay. Elastic bands and hooks.

ARM GUARDS



4034 \$3.25
 Large, extra width hunting guard with two steel stays. Black.



4033 \$2.75
 Wide guard with steel stay for full protection. Black or White.



4032 \$2.50
 Full length, with one-inch stay for full protection. Black, Brown or White.



4031 \$1.50
 Narrow design guard with steel stay for full protection. Black patent leather only.

GLOVES

Specify sizes: Small, Medium, Large or Extra Large.

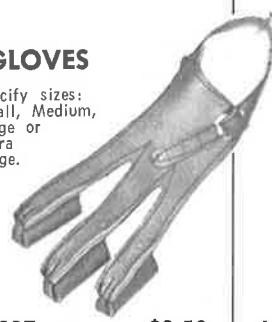

4027 \$2.50
 Closed-end styled glove with soft leather back and soft leather finger stalls for smooth release.



4026 \$1.50
 Leather back with cowhide tips.



4025 \$2.75
 Closed-end styled glove with Cordovan tips. Elastic insert keeps glove back smooth and finger stalls snug. Relieves wrist-strap tension.

TRAINING GUARD



4024 Training Guard \$2.95
 Designed for beginners. Protects the entire forearm. Recommended especially for ranges and schools.



Hip Pocket Quiver



The Scout



The Fleet Lane

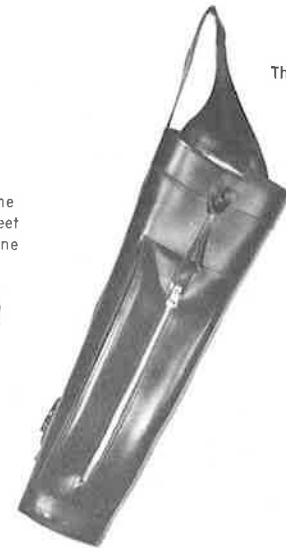

The Companion



The Fleet Combo Quiver



The Michael Combo

4048 HIP POCKET QUIVER \$2.50
 Firm leather with divider and belt flap.

4016 — THE SCOUT \$4.95
 Target Quiver 17" long, will hold six or more arrows. Available in Brown, Black or White. Belt Clip.

4014 — THE FLEET-LANE \$3.95
 Made of durable vinyl with adjustable shoulder strap and arrow divider

4020 — THE COMPANION \$9.95
 Shoulder Quiver — Medium size, 2-division quiver with pocket. Length 19", top 7", bottom 4". Right or Left Hand. Available in Black only.

LEATHER GOODS PACKAGED, PRE-PRICED, NUMBERED for Peg-Board Display



The Badger

The Bobcat

4010 — THE BADGER — Belt Style Leatheride \$1.95
 Holds 12 Arrows

4013 — THE BOBCAT \$1.50
 Vinyl Target Quiver. Heavy, water-proof. Fitted with leather puncture-proof bottom. Belt loop. Ideal for the novice desiring a quiver suitable for target archery.

4019 — THE FLEET COMBO QUIVER \$8.95
 With Powder Pouch — For roving or target archery, flat style quiver. Long double leather belt loop to hold quiver at proper angle for easy draw. Large accessory pocket with flap and heavy snap. New built in powder dispenser on face of pocket. Size 6 1/2" taper to 4 1/2" deep. 3 1/2" wide. 3/4" high. Holds 6-8 arrows. Has divided loop to separate arrows. Made of extra thick top quality leather. Sturdy construction. Black only.

4017 — THE MICHAEL COMBO \$9.95
 DeLuxe Side Quiver — with large zipper pocket. 18" long. Two compartment divider strap, belt clip, score card holder above pocket. A truly DeLuxe side quiver.

BOWCASES



STANDARD PADDED BOWCASE

5105 \$11.95
 Extra wide for full re-curve bow. Archer's brown waterproof cover lined with heavy tan napped flannel quilted to thick padding. 24" zipper opening, web zipper guard to protect bow from scratches. Lengths: 62", 66", 69". Width: 8 1/2".



FLANNEL BOWCASE 5132 \$2.50

Made of canton flannel, soft nap finish. 4 1/2 inch width fits all bows. Adjustable tie-down flap. Lengths: 62", 66", and 69".

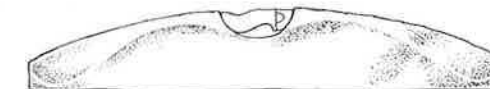

BRACED BOW CARRYING CASE

5127 62" and 66" \$5.95
 Flexible durable outer jacket of canton flannel with soft lining . . . 32-inch zipper. Exposed hand-grip.



HUNTING HEADS

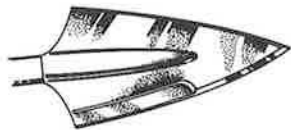

"KING OF THE FOREST"—Two Blade
Fits 21/64", 11/32" shafts
1183-1 11/32", 125 gr...Doz. **\$3.95**



"KING OF THE FOREST"—Three Blade
1147-1 11/32", 125 gr...Doz. **\$3.95**
1148-1 5/16", 100 gr...Doz. **\$3.95**



"KING OF THE FOREST"—Four Blade
Fits 21/64", 11/32" shafts
1185-1 125 gr...Doz. **\$3.95**

SUPER HILBRE
1144-1 11/32", 125 gr. Doz. **\$7.20**



HI-PRECISION—Three Blade
Fits 21/64", 11/32" shafts
1041-1
125 gr...Doz. **\$3.95**

H. T. M. BLUNT POINTS

Tough, flexible rubber point for practice and small game. Packaged.

1208-1 11/32", 125 gr...Doz. **\$3.00**
1207-1 5/16", 65 gr...Doz. **\$3.00**

SAUNDERS BLUDGEON

A soft rubber blunt for practice and small game.

1096 Bag of 5List **\$1.00**

POINTS



FIELD POINTS

Factory No.	Size	Weight	List per Doz.
1500-1	11/32 OD x 5/16 ID	65 Gr.	.80
1501-1	11/32 OD x 5/16 ID	125 Gr.	.90
1502-1	3/8 OD x 11/32 ID	125 Gr.	1.00



FIELD POINTS

Factory No.	Size	Weight	List per Doz.
1503-1	11/32 OD x 5/16 Tapered	125 Gr.	\$1.00
1504-1	3/8 OD x 11/32 Tapered	125 Gr.	1.00

DUO FIELD

1141-1	11/32 OD x 5/16 ID	100 Gr.	\$1.30
1140-1	3/8 OD x 11/32 ID	125 Gr.	1.30



BLUNTS — Parallel Hole — Steel

1505-1	11/32 OD x 5/16 ID	100 Gr.	\$.80
1506-1	3/8 OD x 11/32 ID	125 Gr.	.80

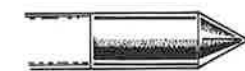

TARGET POINTS — Parallel Hole — Steel

1508-1	5/16 OD x 9/32 ID	45 Gr.	\$.60
1510-1	11/32 OD x 5/16 ID	45 Gr.	\$.60
1511-1	3/8 OD x 11/32 ID	60 Gr.	\$.70



PLASTIC INDEX NOCKS

Factory No.	Size	Per Dozen	Per 100 One Color and Size	Per 1000 One Color and Size
1132-1	11/32" Nocks	\$.45	\$ 3.00	\$15.00
1131-1	5/16" Nocks	.45	3.00	\$15.00
1133-1	9/32" Nocks	.45	3.00	\$15.00
1137-1	1/4" Nocks	.45	3.00	\$15.00

Colors Available: Red, Yellow, Blue, Green, White, Black,

SELECT PORT ORFORD CEDAR SHAFTS

Factory No.	Description	Per Dozen	Per 100 One Size	Per 1000 One Size
1091	Spine Matched, Electronically	\$3.50	\$20.00	\$180.00
1092	Select, matched in spine and to 5 gr. in wt.	\$3.75	\$21.75	\$200.00

SPECIFY: 21/64" or 11/32" shafts; Bow Weights @ 28"

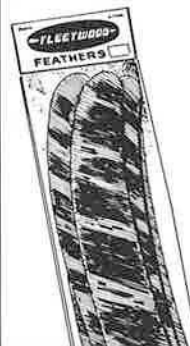

FULL LENGTH FEATHERS

Select Feathers correctly processed.	Per Doz.	Per 100
1205-1 White Dyed Ground Base Feathers	1.00	8.33
1204-1 White Ground Base Feathers	.90	7.50

Colors: Red, Yellow, Orange, Green, Blue, and Black

PRE-SHAPED FEATHERS

Twelve die cuts of a size and color to a package. Lots of 100 die cuts—one size and one color per 100.

Natural White —	Per Pkg.	Per 100 Die Cuts
1191-1 3"	\$.60	\$5.00
1192-1 4"	.80	6.67
1193-1 5"	1.00	8.33
Dyed White —	Per Pkg.	Per 100 Die Cuts
1194-1 3"	\$.70	\$5.83
1195-1 4"	.90	7.50
1196-1 5"	1.10	9.17

FRED BEAR Razorhead TWO BLADE and FOUR BLADE

Fits 5/16" — 21/64" — 11/32" Shafts

No game species in North America has proven too big or too tough for Razorhead. Designed by Fred Bear for more humane sport and greater bow-hunting success.

TWO BLADE BROADHEADS

Standard 5° taper fits both 5/16" and 11/32" shaft. 115 grains. (Length 2 1/2", width 1 1/8").

1149-1Doz. **\$5.20**

FRED BEAR RAZORHEADS—Four Blade

Consists of: One dozen Fred Bear Two Blade broadheads and a dozen razor-auxiliary blades with slot cleaning tool.

1172-1Doz. **\$7.20**

AUXILIARY BLADES

Used to convert Two Blade, or as extra blades for Razorhead. One dozen per package. Weight 10 grains each.

1150-1Doz. **\$2.00**

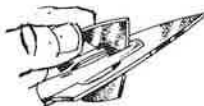
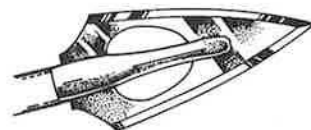

PROVED ON THE WORLD'S GAME TRAILS



ARCHERY ACCESSORY MERCHANDISER



NO. 5600-68 FLEETWOOD ARCHERY MERCHANDISER
INCLUDES FREE \$25.00 METAL PEGBOARD RACK . . . List \$313.95

Quantity	No.	Pack	Description	List	Total	Quantity	No.	Pack	Description	List	Total
12 Bags	1131	12 ea.	Nocks 5/16"	\$.45	\$ 5.40	LEATHER ACCESSORIES 12 Ea. 4041 1 ea. Finger Tab50 \$ 6.00 6 Ea. 4035 1 ea. Finger Tab, Adjustable 1.00 6.00 6 Ea. 4036 1 ea. Finger Tab 1.00 6.00 6 Ea. 4026 1 ea. Glove, Assorted Sizes 1.50 9.00 6 Ea. 4025 1 ea. Glove, Assorted Sizes 2.75 16.50 6 Ea. 4030 1 ea. Armguard 1.00 6.00 6 Ea. 4033 1 ea. Armguard, Hunting 2.75 15.00 6 Ea. 4024 1 ea. Armguard, Training 2.95 17.70 2 Ea. 4013 1 ea. Quiver, Belt 1.50 3.00 6 Pr. 5123 1 pr. Bow Quivers 2.95 17.70 BOW STRINGS 12 Ea. 7088 1 ea. Hemp, Single Loop35 4.20 6 Ea. 7090 1 ea. Dacron, Single Loop 1.00 6.00 24 Ea. 7001 1 ea. Dacron, 10 Strand, Assorted 1.00 24.00 18 Ea. 7003 1 ea. Dacron, 14 Strand, Assorted 1.50 27.00 12 Ea. 5128 1 ea. Bow String Wax25 3.00 \$313.95					
12 Bags	1132	12 ea.	Nocks 11/32"	.45	5.40						
12 Ea.	5113	1 ea.	Arrow Rest—Wool Pile	.50	6.00						
12 Ea.	5112	1 ea.	Arrow Rest—Feather	.50	6.00						
12 Ea.	5118	1 ea.	Para Rest	.75	9.00						
12 Pr.	5099	1 pr.	Super Brush Buttons	.70	8.40						
12 Ea.	5122	1 ea.	Bow Tip Protectors	.50	6.00						
6 Bags	1167	12 ea.	3" Feathers Pre-Shaped	.55	3.30						
6 Bags	1168	12 ea.	4" Feathers Pre-Shaped	.65	3.90						
6 Bags	1169	12 ea.	5" Feathers Pre-Shaped	.75	4.50						
12 pr.	5175	1 pr.	Nylon Nocking Points	1.00	12.00						
6 Bags	1508	12 ea.	Target Points 5/16"	.60	3.60						
6 Bags	1510	12 ea.	Target Points 11/32"	.60	3.60						
6 Bags	1501	12 ea.	Field Points 5/16"	.90	5.40						
6 Bags	1502	12 ea.	Field Points 11/32"	1.00	6.00						
6 Bags	1182	3 ea.	Hunting Heads 5/16" 2 Bl.	1.00	6.00						
6 Bags	1183	3 ea.	Hunting Heads 11/32" 2 Bl.	1.00	6.00						
6 Bags	1147	3 ea.	Hunting Heads 11/32" 3 Bl.	1.00	6.00						
6 Bags	1185	3 ea.	Hunting Heads 11/32" 4 Bl.	1.25	7.50						
3 Ea.	5092	1 ea.	Bow Sight Fleetwood	1.50	4.50						
3 Ea.	5095	1 ea.	Bow Sight Zip Klik	5.95	17.85						
6 Ea.	5174	1 ea.	Bow Cover Camouflage	1.50	9.00						



ARCHERY

PRE-PRICED, PACKAGED FOR PEG BOARDS

ACCESSORIES

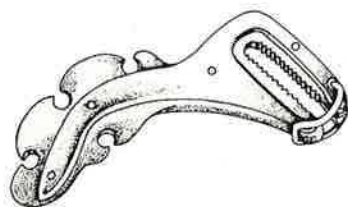

KWIKEE KWIWER

New open-end construction eliminates cutting and fitting. Steel clamp is permanently installed.

5164 Deluxe Pair \$3.95

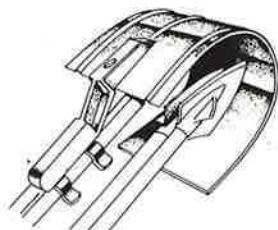

KWIKEE KOVER

Featherweight broadhead shield. Does not interfere with normal removal of arrows while hunting.

5163 each \$1.95

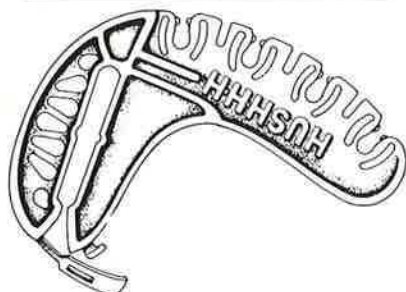

HUSH-H-H BOW QUIVER

No screws — No clamps — No tape. Made out of sturdy plastic, holding 4 arrows.

5001 Pair \$2.95

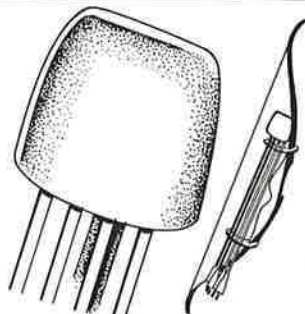

HUSH-H-H HOOD

Attaches firmly to all Hush-h-h Quivers. Offers full protection for hunting points.

5001-H each \$1.50

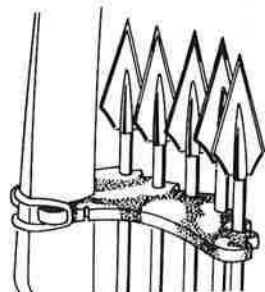

NATIONAL CAMOUFLAGE BOW QUIVER

Holds five arrows securely, fits all bows with snap-on feature. Made of 100% specially compounded rubber.

5123 Pair \$2.95



FLEETWOOD FEATHER ARROW REST

Aids smooth, quiet release and protects cresting. For any bow having an arrow rest shaft.

5112-1 Per Doz. \$6.00

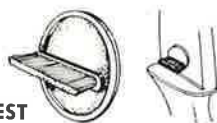

PARA-REST

Horizontally mounted. Top grade Nylon brush type with handsome finished, genuine leather backing. Ideal for plastic feathered arrows.

5118-1 Per Doz. \$9.00



PIERSON WINDOW FEATHER ARROW REST

Horizontal feather rest with a supporting feather. Feathers mounted on an adhesive coated thin aluminum backing which is covered with cellophane. Waterproofed. Absorbs error.

5116-1 (SPECIFY IF LEFT HAND) Per Doz. \$9.00

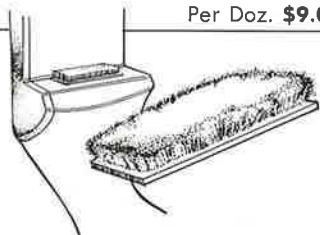

FLEETWOOD SILENT ARROW REST

Water resistant wool pile aluminum base. Long wearing. Reduces shaft and feather drag to a minimum.

5113-1 Per Doz., List \$6.00

FLEETWOOD ZIP-KLIK "Tabulator" BOW SIGHT

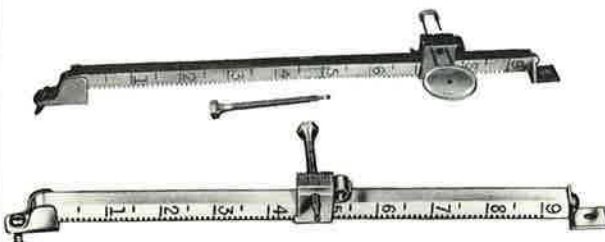

5095 with pin \$5.95
5094 with plain lens \$7.95

The Zip-Klik "Tabulator" is made of long lasting, rust resistant brass and aluminum. Dependable, accurate and easy to use. Simple finger-tip adjustment. Machined parts throughout. Screw setting windage, calibrated for distance settings.

FLEETWOOD PARTS

5138 Calibrated Vertical Bar \$2.00
5137 Horizontal Windage Sight Screw50
5136 Carriage 1.50
5135 Upper Bracket75
5134 Lower Bracket95
5133 Spring25



FLEETWOOD-RANGER BOW SIGHT

Designed for rental bows at archery lanes. Rugged, yet accurate for precision shooting. Complete with sight pin and peep sight, adjustable windage, positive spring friction yardage adjustment, 7" long, screw mounted.

5093 Fleet-Ranger Bow Sight each \$2.95



FLEETWOOD BOW SIGHT

Made of sturdy cold rolled steel. New, No Zig-zag Bracket. Vertical Bar calibrated in 1/16". Steel horizontal bar offering Peep, Point, or Post aiming. Easily changed to a vertical position in bow case. Individually carded.

5092 Fleetwood Bow Sight each \$1.50

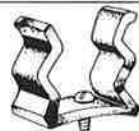

ARROW CLIPS

The perfect clip for tackle boxes, arrow display racks. Made of finest spring steel, nickel plated over copper and burnished.

5129 Arrow Clip and Screw, packed per gross \$7.20 Gross (List .60 doz.)

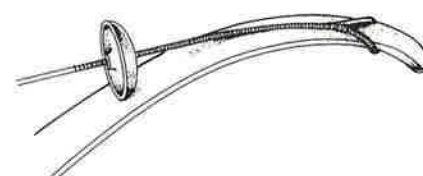

BRUSH BUTTONS

Super in brush proofing action ... dampening string noise. Fits all bows!

5100-1 Doz. pair "Standards" Per Doz. \$7.20

5099-1 Doz. pair "Supers" Per Doz. \$8.40

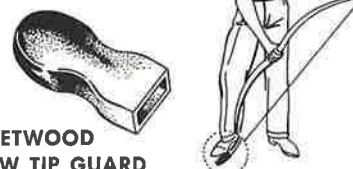

FLEETWOOD BOW TIP GUARD

Lightweight plastic with special molded contour to provide positive grip. Holds bow string loop in position securely. Prevent bow tip damage and keep your bow new looking! Fits all Bows.

5122 Per Doz. \$6.00



KWIKEE STRING SILENCER

Made of neoprene rubber. Helps eliminate string vibration.

5171-1 Per Doz. \$12.00

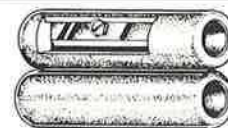

TAPER TENON TOOL

Molded of plastic, side by side cutters—one for Nock, one for Point. Razor sharp blades.

Each \$1.75 Extra Blades Each \$.50

5109-TT1 11° Nock Taper and 5/16" Parallel Point Tenon
5108-TT2 5/16" Parallel Shaft—11° Nock and 5° Point Taper
5107-TT3 11/32" Parallel Shaft—11° Nock and 5° Point Taper
5106-TT4 11/32" Tapered to 5/16" Shaft—11° Nock and 5° Point Taper

FLEETWOOD CAMOUFLAGE BOW COVER

Two-piece cover slips over bow limbs for camouflage. Elastic thread for snug fit.

5174 Individually Packaged, Each \$1.50

EASTON FLETCHING CEMENT

For aluminum arrows.
5096-1 12 per box dozen \$7.20

EVERFAST FLETCHING CEMENT

Fast drying, colorless.
5097-1 12 per box dozen \$4.20

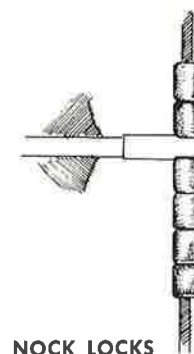

ARROW NOCK LOCKS

12 pair Arrow Nock Locks neatly carded on attractive display card.

5119-1 12 pair Per Card \$6.00

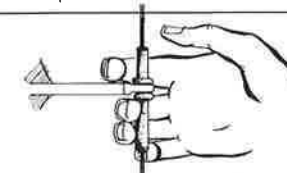

NOCKING POINTS

No tools needed. Full 3-finger coverage.

5175-1 TRUE-SPOT Per Doz. \$12.00

5114-1 NOCK-RITE Per Doz. \$12.00

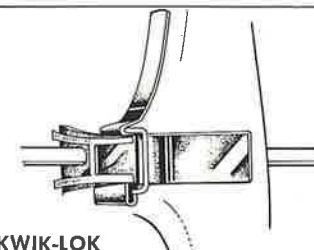

KWIK-LOK

A sensational new development! Holds arrow in nocked position but releases instantly when arrow is drawn. Cannot affect the flight of arrow. Easy-to-apply. Pressure-sensitive surface so Kwik-Lok will not mar bow.

5176 Individually carded Only \$2.25



FLEETWOOD GROUND QUIVER—(ALUMINUM) Rustproof

6 Per Display
5156 Holds 12 Arrows Each \$1.50
5157 Knock down type holds bow and 12 arrows Each \$2.95

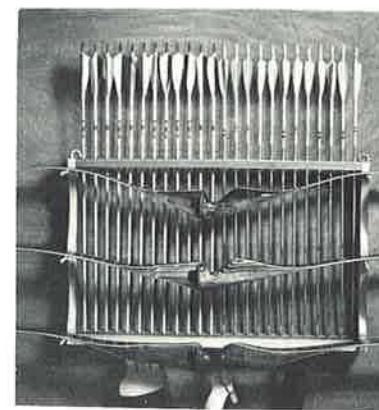

FLEETWOOD NO-TWIST BOW STRINGER

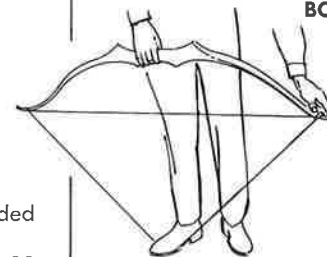

No. 5172 \$2.50 ea.

Prevents bow limbs from being twisted due to improper stringing. Simple to use. Handy — fits into pocket.



FLEETWOOD SCENT VENT

Eliminate soiled hands and clothing. Simply saturate wick with scent, screw cover closed for airtight seal and store anywhere. To use, pin to clothing, unscrew cover until holes are exposed.

No. 5236 ea. \$1.50

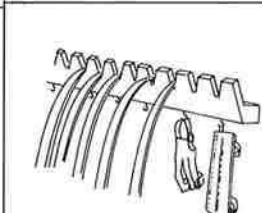

FLEETWOOD BOW-ACCESSORY RACK

Holds 8 bows in vertical position on 16" of wall space. Prevents twist or warp of bow limbs.

No. 5161 \$2.95 ea.



BOWSTRING SILENCER

Kills string noise. Converts high frequency sound into whisper instantly.

No. 5170 Pr. \$.75

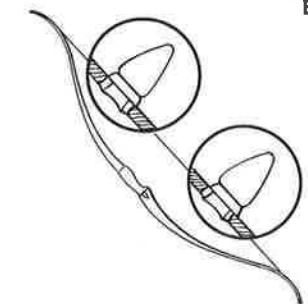

BOW STRING SILENCER

Helps prevent game from "jumping the string."

No. 5169 12 per card \$4.68

FLEETWOOD BOW & ARROW WALL RACK

Do-it-yourself kit comes packaged complete, with instructions for fast assembly. Made of California Redwood, with metal wall hangers and special accessories hooks. Holds 6 bows and 2 dozen arrows. Display in Box.

5160 Each \$4.95

Packed 10 Per Carton



REGULATION TARGET FACES

Pre-Priced and Packaged for Peg Board

SELF-SERVICE TARGET CENTER



1968 Best Sellers
FLEETWOOD ARCHERY
TARGET ASSORTMENT

No. 5006

No.	Description	Unit Pack	Price Pack	No. Units In Rack	Total List Price
5068	24" Deer Faces	2	\$1.00	10	\$10.00
5054	24" Four Color Faces	2	\$1.00	10	\$10.00
5067	18" Fox Colored Faces	3	\$1.00	10	\$10.00
5052	16" Four Color Faces	4	\$1.00	10	\$10.00
5066P	12" Colored Pheasant	4	\$1.00	10	\$10.00
5066B	12" Colored Bobcat	4	\$1.00	10	\$10.00

Total Retail Value . . . \$60.00

One Display Rack To A Shipping Carton—
Weight: 30# per Carton

COLORED ANIMAL FACES

No.	Size	Pre-Priced Pack
5068	24" Deer	2/\$1.00
5067	18" Fox	3/\$1.00
5066	12" Bobcat or Pheasant	4/\$1.00
5065	6" Squirrel	10/\$1.00

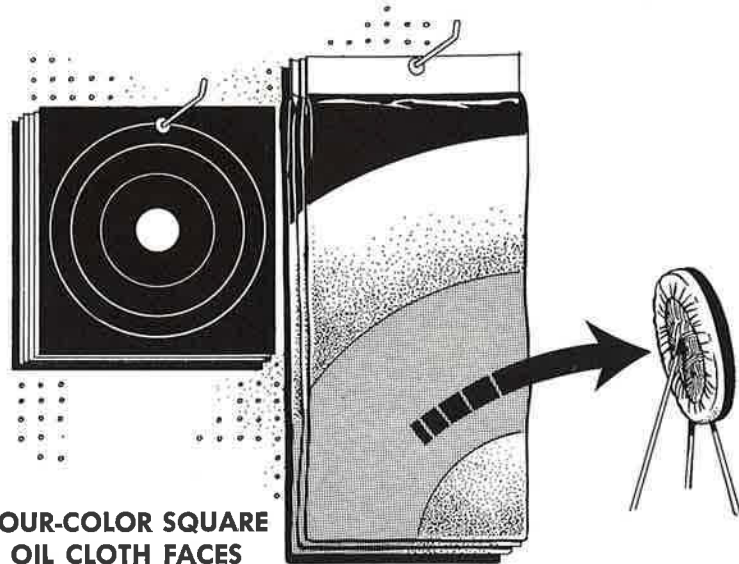

FOUR-COLOR SQUARE
OIL CLOTH FACES

OIL CLOTH	Packed 1-Per Bag	Price each
No. 5049	48"	\$4.50
5047	36"	\$3.50
5045	24"	\$2.50

SKIRTED OIL CLOTH FACES

No.	Size	Price (1 per bag)
5048	48"	\$6.50 ea.
5046	36"	\$5.00 ea.
5044	24"	\$3.50 ea.

HEAVY TAG—4-COLOR SQUARE

No.	Size	Pre-Priced Pack
5058	48"	1/\$1.75
5056	36"	1/\$1.00
5054	24"	2/\$1.00
5052	16"	4/\$1.00
5059	12"	6/\$1.00

Pre-Priced Packaged
for Peg Board Displays

OFFICIAL PAA INDOOR ROUND HEAVY TAG — NO. 5155

16" 6/\$1.00

OFFICIAL NFAA FIELD FACES

HEAVY TAG	No.	Size	Pre-Priced Pack
	5082	24"	4/\$1.00
	5081	18"	6/\$1.00
	5080	12"	8/\$1.00
	5079	6"	10/\$.50
Set of 36 Faces:			
B 36			\$3.95



FLETCHING TOOLS

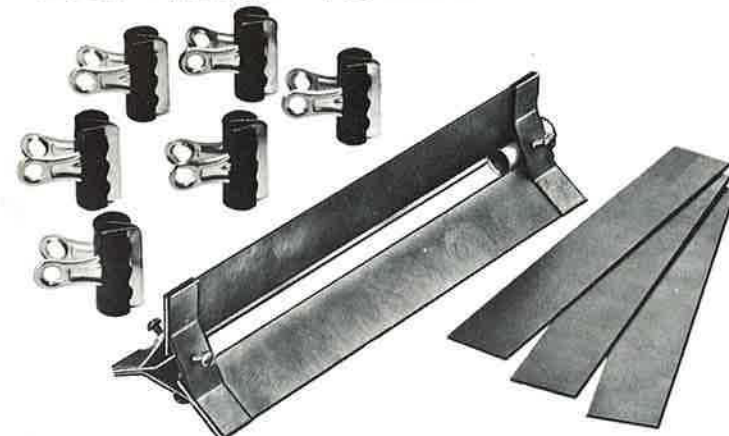

FLEETWOOD THREE FEATHER FLETCHING TOOL

Assembled — Ready to Use

All metal. Fletches all three feathers at once accurately. Guaranteed to give satisfaction. Fast and easy to operate.

5090 Fletches 3", 4" and 5 1/2" Feathers	\$3.00
5091 Fletches 3", and 4" Feathers	\$2.50

FLEETWOOD THREE FEATHER SPIRAL FLETCHING TOOL

Assembled — Ready to Use

Fleetwood's Spiral Fletching Tool is precisely die shaped to fletch perfectly each feather in exactly a 1 in 10 spiral. Does everything tools costing many times more will do and does it 3 times faster. Accurate, fast and easy to operate. Overall length of tool 7". Fletches up to 5 1/2" feathers.

5089 Spiral Fletchers for Left Wing Feathers	\$3.50
5088 Spiral Fletchers for Right Wing Feathers	\$3.50



FLEETWOOD FOUR FEATHER FLETCHERS

Assembled — Ready to Use

Fletches all four feathers at once accurately. Fast and easy to operate. Guaranteed to give satisfaction.

5149 Die shaped to fletch in 75° to 105°	Only \$3.95 each
--	------------------

FLEETWOOD SPIRAL FOUR FEATHER FLETCHERS

Assembled — Ready to Use

5083 right spiral	\$3.95
5159 left spiral	\$3.95

When ordering, be sure to state right or left spiral.

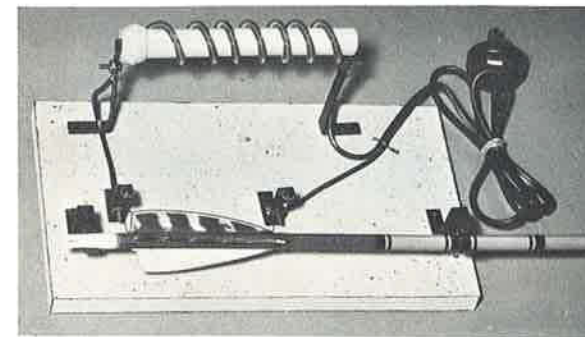

FLEETWOOD FEATHER BURNER

Feather Burner Assembled with resistance element. Simply plug in — ready for use . . . 3 extra Nichrome feather wires included free.

5165	\$4.95
------	--------

FLEETWOOD FEATHER BURNER KITS

Electric assembly kit for feather burner, everything complete including resistance element. With or without mounting board.

5166 without Mounting Board	\$2.95
-----------------------------	--------

5167 Mounting board included with holes pre-drilled	\$3.95
---	--------

Extra lengths of Nichrome Wire available on request.

5086 8" lengths	each 10c
5085 12" lengths	each 15c

OFFICIAL ANIMAL ROUND TARGET FACES

OFFICIAL ANIMAL ROUND FACES

Group 1 — Bear, Deer or Moose	
Group 2 — Antelope, Mountain Lion or Ram	
Group 3 — Raccoon, Goose, Javelina or Coyote	
Group 4 — Pheasant, Prairie Dog, Jack Rabbit or Duck	

HEAVY TAG

No.	Group	Size	Set Incl.	Pre-Priced Pack
5022	1	40"x28"	3	\$2.25
5019	2	28"x22"	3	\$1.50
5015	3	22"x14"	4	\$1.40
5011	4	14"x11"	8	\$1.60

OAR 18 Set of 18 Faces	\$6.75
------------------------	--------



**We're Better Equipped
to Serve You in our
NEW
BUILDING!**

From new IBM equipment to modern truck loading dock . . . our new, completely remodeled building is geared to provide prompt and efficient delivery of our complete line of Archery supplies. New techniques in bow and arrow fabrication . . . streamlined methods of assembly and packaging . . . ample warehouse space for stock piling . . . all add up to time-saving processing of orders in one of the most modern and completely equipped Archery plants in the U.S.A.

FLEETWOOD ARCHERY
902 OGDEN AVENUE ■ SUPERIOR, WISCONSIN 54880