

# HOSE

## RED AIR AND GENERAL PURPOSE HOSE

- **Uses:**  
Handles air, water and spray solutions for many industrial, construction and automotive uses.
- **Construction:**  
Tube and cover - EPDM rubber.
- **Reinforcement:**  
Synthetic cord.
- **Fittings:**  
Hose barb fittings and 82 series "push-lok" fittings (with a hose ferrule).



HOSE I.D.	J&B #	LENGTH	HOSE ENDS	WORKING PRESSURE
<b>1/4</b>	24814	25 FT.	1/4 MPT	300 PSI
	24815	50 FT.	1/4 MPT	
	24816	25 FT.	NONE	
	24817	50 FT.	NONE	
	24818	100 FT.	NONE	
	* 24819	1 REEL	NONE	
<b>3/8</b>	24820	25 FT.	1/4 MPT	250 PSI
	24821	50 FT.	1/4 MPT	
	24823	25 FT.	NONE	
	24824	50 FT.	NONE	
	24825	100 FT.	NONE	
	* 24826	1 REEL	NONE	
<b>1/2</b>	24827	25 FT.	1/2 MPT	250 PSI
	24828	50 FT.	1/2 MPT	
	24829	25 FT.	NONE	
	24830	50 FT.	NONE	
	24831	100 FT.	NONE	
	* 24832	1 REEL	NONE	



\* Part#'s 24819, 24826 & 24832 are 1 Reel (500 ft.). Any length less than 1 reel can be sold by breaking these part#'s.

# HOSE

## GARDEN HOSE

Neverkink

- Commercial, microshield anti-microbial protection.
- Kink and twist resistant; Self-straightening.
- Heavy duty power coil coupling & collar.



J&B #	SIZE	COLOR	QTY
R71928	5/8" x 50'	BLACK	EA

## HOSE NOZZLE

Pistol Grip

- Large plastic pistol grip nozzle.
- Durable rustproof plastic body.
- Male hose threaded front for attaching accessories.



J&B #	QTY
R75195	EA

## HOSE COUPLER

Male End

- Nylon. Stainless steel screws; Reusable.
- Use on rubber or plastic hose.



J&B #	SIZE	QTY
R72943	Fits 5/8-3/4	EA

Female End

- Nylon. Stainless steel screws; Reusable.
- Use on rubber or plastic hose.



J&B #	SIZE	QTY
R72945	Fits 5/8-3/4	EA

## RUBBER HOSE STOPS

- Two-piece rubber hose stops prevent your hose from completely rewinding into the reel.

J&B #	HOSE SIZE	COLOR	QTY
50321	1/4	BLACK	EA
50322	3/8	BLACK	EA
50323	1/2	BLACK	EA



# HOSE

## BLACK MULTI-PURPOSE 801 "PUSH-LOK" HOSE

Hose Cover Need not be removed for assembly

- **Construction:**

Tube: Synthetic rubber Reinforcement: One fiber braid.  
Cover: Synthetic rubber, MSHA accepted.

- **Uses:**

Pneumatic, petroleum base hydraulic fluid, lubricating oils and antifreeze solutions.



- **Fittings:**

82 series "push-lok" fittings.

J&B #	HOSE I.D.	HOSE O.D.	WORKING PRESSURE	BURST PRESSURE	QTY	Per reel
50404	1/4	.500	350 PSI	1000 PSI	PER/FT	600 ft
50406	3/8	.630	350 PSI	1000 PSI	PER/FT	450 ft
50408	1/2	.780	300 PSI	1000 PSI	PER/FT	300 ft

## RED MULTI-PURPOSE 801 "PUSH-LOK" HOSE

Hose Cover Need not be removed for assembly

- **Construction:**

Tube: Synthetic rubber Reinforcement: One fiber braid.  
Cover: Synthetic rubber, MSHA accepted.

- **Uses:**

Pneumatic, petroleum base hydraulic fluid, lubricating oils and antifreeze solutions.



- **Fittings:**

82 series "push-lok" fittings.

\*\*\*No broken rolls

J&B #	HOSE I.D.	HOSE O.D.	WORKING PRESSURE	BURST PRESSURE	QTY
V61200	1/2	0.78	300 PSI	1000 PSI	300 FT
V61201	3/4	1.03	300 PSI	1000 PSI	200 FT
V61202	1	1.28	200 PSI	1000 PSI	150 FT

# HOSE

---

## BLACK MULTI-PURPOSE "FLEX-LOC" HOSE

Hose Cover Need not be removed for assembly



- **Construction:**  
Tube: Nitrile, RMA Class A Reinforcement: Spiral Polyester Cover: Nitrile/PVC Blend
- **Uses:**  
Handles air, water and petroleum products. Not recommended for unleaded gasoline.
- **Fittings:**  
82 series "push-lok" fittings.

J&B #	HOSE I.D.	HOSE O.D.	WORKING PRESSURE	BURST PRESSURE	QTY
50410	5/8	.910	250 PSI	1000 PSI	PER/FT
50412	3/4	1.03	250 PSI	1000 PSI	PER/FT

# HOSE BARB FITTINGS

## Advantages:

All Parker hose barb fitting pipe threads are made to Dryseal standards. Connectors, unions, nuts and extended elbows and tees are machined from CA 360 and CA 345 brass.

**Temperature and Working Pressure Ranges:** Note: *These fittings are intended for use with hose clamps.*  
 From -40° to +160°F at 150 PSI maximum.

## HOSE BARBS



J&B #	HOSE SIZE	PIPE THREAD	QTY
22218	1/8	1/8	10
22220	3/16	1/8	10
32055	1/4	1/8	10
21056	1/4	1/4	10
32057	1/4	3/8	10
60082	5/16	1/8	10
32056	5/16	1/4	10
32070	5/16	3/8	10
32054	3/8	1/8	5
32058	3/8	1/4	5

J&B #	HOSE SIZE	PIPE THREAD	QTY
32059	3/8	3/8	5
32060	3/8	1/2	5
38907	1/2	1/4	5
38908	1/2	3/8	5
38416	1/2	1/2	5
22195	1/2	3/4	5
22222	5/8	1/2	5
60088	5/8	3/4	5
22224	3/4	1/2	5
38415	3/4	3/4	5
32089	1	3/4	2

## HOSE MENDERS

J&B #	HOSE SIZE	QTY
22230	3/16	10
22468	1/4	10
32061	5/16	10
22470	3/8	10

J&B #	HOSE SIZE	QTY
32053	1/2	10
32087	5/8	5
32088	3/4	5
60081	1	2



## 90 DEGREE HOSE BARBS

J&B #	HOSE SIZE	PIPE THREAD	QTY
32052	3/16	1/8	5
32065	1/4	1/8	5
32066	1/4	1/4	5
32051	5/16	1/4	5
32067	3/8	1/4	5
32068	3/8	3/8	5
32069	1/2	3/8	5



# HOSE BARB FITTINGS

---

## Advantages:

All Parker hose barb fitting pipe threads are made to Dryseal standards. Connectors, unions, nuts and extended elbows and tees are machined from CA 360 and CA 345 brass.

## Temperature and Working Pressure Ranges:

From -40° to +160°F at 150 PSI maximum.

## Note:

*These fittings are intended for use with hose clamps.*

---

## FEMALE PIPE HOSE BARB

J&B #	HOSE SIZE	PIPE THREAD	QTY
24400	1/4	1/8	5
24401	1/4	1/4	5
24402	3/8	1/4	5
24403	3/8	3/8	5
24404	1/2	3/8	5



## BEADED HOSE BARB TO MALE PIPE

- Excellent for use on **HEATER HOSE**

J&B #	HOSE	PIPE	QTY
38670	5/8	3/8	2
38672	5/8	1/2	2
38674	3/4	1/2	2



## BEADED HOSE BARB 90° ELBOW TO MALE PIPE

- Excellent for use on **HEATER HOSE**

J&B #	HOSE	PIPE	QTY
38676	5/8	3/8	2
38678	5/8	1/2	2
38680	3/4	1/2	2



# HOSE BARB FITTINGS

---

## HOSE BARB TEE

J&B #	HOSE SIZE	QTY
60083	3/16	5
60084	1/4	5
60085	5/16	5
60086	3/8	5
60087	1/2	5



---

## GARDEN HOSE FITTINGS



J&B #	HOSE BARB	HOSE THREAD	QTY
38260	1/2	3/4	5
32064	5/8	3/4	5
46112	3/4	3/4	5

J&B #	HOSE BARB	HOSE SWIVEL	QTY
38261	1/2	3/4	5
32063	5/8	3/4	5
46113	3/4	3/4	5

---

## SWIVEL UNION HOSE ADAPTER

- Brass swivel union adapter.
- Lead free compliant product which meets public law 111-380.



J&B #	HOSE THREAD	QTY
60089	3/4 X 3/4	5

# BRASS "PUSH-LOK" FITTINGS

## 82 SERIES "PUSH-LOK" FITTINGS

82 SERIES "PUSH-LOK" FITTINGS CAN BE USED WITH THE FOLLOWING HOSES . . .

MULTI-PURPOSE "PUSH-LOK" LOW PRESSURE HOSE -

Page 247

- Suitable for vacuum service NO HOSE CLAMPS REQUIRED.

### HOSE UNIONS

#### 38282

J&B #	PARKER #	HOSE SIZE	QTY
22757	38282-4-4B	1/4	10
22758	38282-6-6B	3/8	10
52616	38282-8-8	1/2	5
52768	38282-10-10	5/8	1

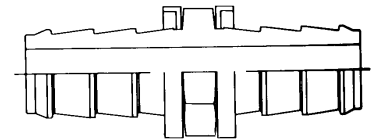

### SAE (JIC) 37° SWIVEL

#### 30682

J&B #	PARKER #	HOSE SIZE	TUBE		QTY
			SIZE	THREAD	
51330	30682-4-4B	1/4	1/4	7/16-20	10
52600	30682-5-4B	1/4	5/16	1/2-20	10
52620	30682-6-6B	3/8	3/8	9/16-18	5
51334	30682-8-6B	3/8	1/2	3/4-16	10
52621	30682-8-8B	1/2	1/2	3/4-16	5

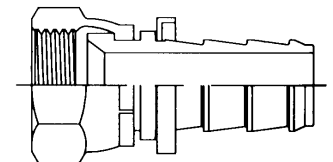

### MALE SAE (JIC) 37°

#### 30382

J&B #	PARKER #	HOSE SIZE	TUBE		QTY
			SIZE	THREAD	
52588	30382-6-6B	3/8	3/8	9/16-18	5

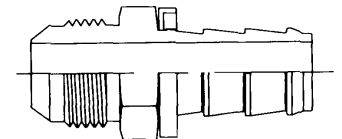



# BRASS "PUSH-LOK" FITTINGS

## 82 SERIES "PUSH-LOK" FITTINGS

J&B #	PARKER #	HOSE SIZE	TUBE		QTY
			SIZE	THREAD	
52604	32882-4-4B	1/4	1/4	7/16-24	5
52606	32882-5-4B	1/4	5/16	1/2-20	5
52608	32882-6-6B	3/8	3/8	5/8-18	5

### SAE MALE INVERTED SWIVEL

32882

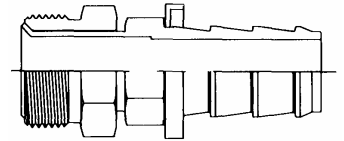

J&B #	PARKER #	HOSE SIZE	TUBE		QTY
			SIZE	THREAD	
52767	32982-3-4B	1/4	3/16	3/8-24	5
52610	32982-4-4B	1/4	1/4	7/16-24	5
52612	32982-5-4B	1/4	5/16	1/2-20	5
52614	32982-6-6B	3/8	3/8	5/8-18	5

### SAE FEMALE INVERTED RIGID

32982

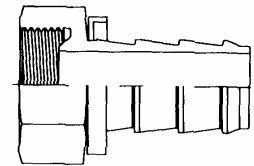

J&B #	PARKER #	HOSE SIZE	PIPE THREAD	QTY
51310	30182-2-4B	1/4	1/8-27	10
51312	30182-4-4B	1/4	1/4-18	10
51314	30182-4-6B	3/8	1/4-18	10
51316	30182-6-6B	3/8	3/8-18	10
51318	30182-8-6B	3/8	1/2-14	10
52590	30182-6-8B	1/2	3/8-18	5
52592	30182-8-8B	1/2	1/2-14	5
52596	30182-8-10B	5/8	1/2-14	5
52598	30182-12-12B	3/4	3/4-14	5

### MALE PIPE NPTF

30182



# BRASS "PUSH-LOK" FITTINGS

## 82 SERIES "PUSH-LOK" FITTINGS

J&B #	PARKER #	HOSE SIZE	TUBE		QTY
			SIZE	THREAD	
51320	30482-4-4B	1/4	1/4	7/16-20	10
51322	30482-5-4B	1/4	5/16	1/2-20	10
51324	30482-6-6B	3/8	3/8	5/8-18	10

MALE SAE  
45°

30482

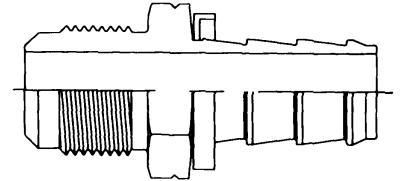

J&B #	PARKER #	HOSE SIZE	TUBE		QTY
			SIZE	THREAD	
51330	30882-4-4B	1/4	1/4	7/16-20	10
52600	30882-5-4B	1/4	5/16	1/2-20	10
51332	30882-6-6B	3/8	3/8	5/8-18	10
51334	30882-8-6B	3/8	1/2	3/4-16	10
52621	30882-8-8B	1/2	1/2	3/4-16	5

SAE  
45° SWIVEL

30882

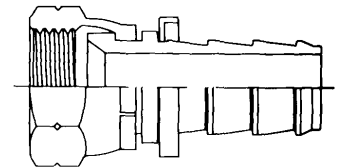

J&B #	PARKER #	HOSE SIZE	PIPE THREAD	QTY
51336	30282-4-6B	3/8	1/4-18	5
51337	30282-6-6B	3/8	3/8-18	5

FEMALE PIPE  
NPTF - RIGID

30282

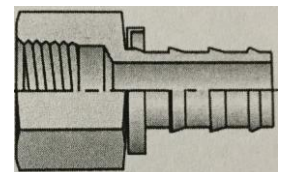

# COUPLERS & PLUGS

## FEATURES & BENEFITS

- **Long Service Life:** Zinc plating provides a non-corrosive finish. Heat treating hardens critical wear points. Molded Buna-n seals create a leak proof connection.
- **Efficient Performance:** Tubular valve design provides high flow rates. Steel locking balls ensure connection holds tight under the most rugged applications. Spring loaded sliding outer sleeve allows quick connect/disconnect.
- **Plated steel couplers have hardened steel balls and stainless steel springs. Brass couplers have stainless steel balls and springs.**
- **Coupler plugs are heat treated and plated to reduce wear on critical mating surfaces.**

WARNING: Couplers and Plugs on these four pages are intended for use on compressed air lines only. All have a maximum rated working pressure of 300 PSI (unless specified).

## INDUSTRIAL/HANSEN INTERCHANGE SERIES



BODY SIZE	FEMALE PLUG	PIPE THRD	MALE PLUG	PIPE THRD	FEMALE COUPLER	PIPE THRD	MALE COUPLER	PIPE THRD
1/4"	21034	1/4	21033	1/4	22744	1/4	21032	1/4
1/4"					^40991	1/4		
1/4"					*22750(Brass)	1/4		
1/4"					-40966(Brass)	1/4	-40967(Brass)	1/4
1/4"	22460	3/8	22462	3/8	40984	3/8	40987	3/8
1/4"					21727(Brass)	3/8		
3/8"	40986	1/4	40985	1/4	40988	1/4	22499	1/4
3/8"	22494	3/8	22495	3/8	22496	3/8	22497	3/8
1/2"	21620	3/8	21621	3/8	21622	3/8	21623	3/8
1/2"	21624	1/2	22742	1/2	22743	1/2	22502	1/2

^ 40991 is Milton #715 - 40967 is Coilhose #15x4M

\* 22750 is Parker #B23

- 40966 is Coilhose #15x4F

# COUPLERS & PLUGS

## INDUSTRIAL/HANSEN INTERCHANGE (CONT.)



BODY SIZE	PLUG	HOSE ID	COUPLER	HOSE ID	AUTO COUPLER	PIPE THREAD
1/4"	21625	1/4	21728	1/4	* 22760	1/4
1/4"	*42020	3/8	*42022 (Brass)	3/8		
3/8"	22761	3/8	22762	3/8		
1/2"	21626	1/2	21627	1/2		

\* 42020 is Parker #H9C \* 42022 is Parker #B20-5B \* 22760 is Milton #775

## AUTOMOTIVE STANDARD SERIES



BODY SIZE	FEMALE PLUG	PIPE THRD	MALE PLUG	PIPE THRD	FEMALE COUPLER	PIPE THRD	MALE COUPLER	PIPE THRD
3/8"	21628	1/4	21730	1/4	21732	1/4	21629	1/4
3/8"	21630	3/8	22749	3/8	21731	3/8	21631	3/8
3/8"					22748 (Brass)	3/8		
3/8"	21632	1/2	21729	1/2	21633	1/2	22747	1/2
1/2"	21634	3/8	40938	3/8	21622	3/8	21623	3/8
1/2"	40936	1/2	21635	1/2	22743	1/2	22502	1/2

\* 22748 is Parker #B15

# COUPLERS & PLUGS

## ARO SERIES

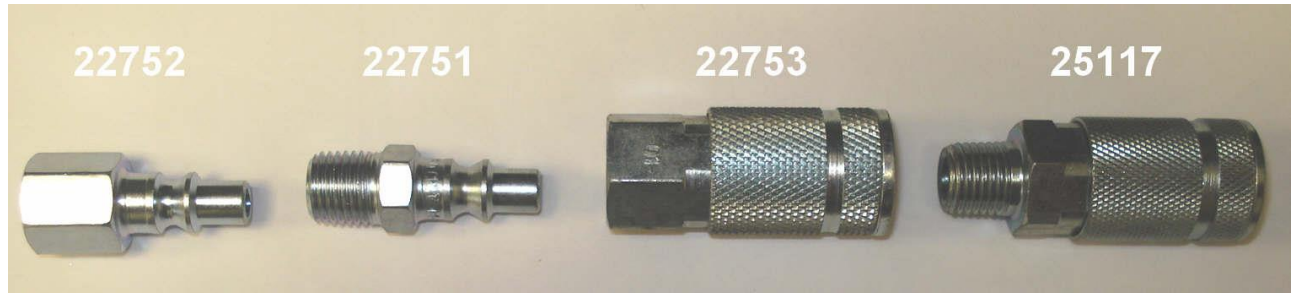

BODY SIZE	FEMALE PLUG	PIPE THRD	MALE PLUG	PIPE THRD	FEMALE COUPLER	PIPE THRD	MALE COUPLER	PIPE THRD
1/4"	22752	1/4	22751	1/4	22753	1/4	25117	1/4
1/4"					*22759(Brass)	1/4		
1/4"					-40970(Brass)	1/4		

\*22759 is Parker # B53

-40970 is Coilhose # 14x4F

## LINCOLN SERIES



BODY SIZE	FEMALE PLUG	PIPE THRD	MALE PLUG	PIPE THRD	FEMALE COUPLER	PIPE THRD
1/4"	22755	1/4	22754	1/4	22756	1/4

# COUPLERS & PLUGS

## COMBO COUPLER

- FITS ALL 1/4" ARO STYLE, 1/4" AUTOMOTIVE STANDARD, 1/4" INDUSTRIAL, 1/4" LINCOLN "LONG STEM," INTERCHANGE PNEUMATIC PLUGS.
- Convenient push-to-connect design sleeve makes connection/disconnection quick and easy.
- Heavy-duty construction assures reliable service under the most demanding conditions.
- Temperature Range: -40° to 240° F; Heavy Duty 150 P.S.I.

FEMALE COUPLER	BODY SIZE	PIPE THREAD	VENDOR	VENDOR NUMBER	QTY
22498	1/4"	1/4 BRASS	PARKER	UC-251-4FP	EA
40974	1/4"	1/4 BRASS	COILHOSE	150U	EA

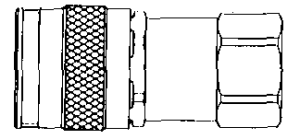

## E-Z-MATE SAFETY COUPLER

- Exhaust type couplers designed to exhaust air pressure prior to disconnection, allowing for coupling and uncoupling at zero pressure which greatly reduces the force required to couple and uncouple and minimizes the possibility of hose-whip.
- Interchange with Industrial series.
- Rated pressure 300 psi.

J&B #	PARKER#	SIZE	QTY
22469	HF-251-4P	1/4"	EA



## NON-MARRING COMPOSITE COUPLERS

- Manufactured out of a heavy-duty, high-impact fiberglass composite, which protects finished surfaces from scratching & marring that occur with brass or steel couplers.
- Can be used with any standard **industrial interchange** connector.

J&B#	STYLE	BODY SIZE	PIPE THREAD	COILHOSE NUMBER	QTY
40992	MALE	1/4"	1/4	152C	EA
40993	FEMALE	1/4"	1/4	150C	EA



40992











40993



# IDENTIFYING COUPLERS & PLUGS

## AMFLO BRAND

SERIES	PLUGS	PLUG DESCRIPTION	COUPLERS	GROOVE CONFIGURATION
HANSEN/ IND. INTER.		Short Nose with rounded neck		2 Narrow
AUTOMOTIVE		Very Short Nose		1 Narrow
ARO		Long Nose with countersunk neck		1 Wide
LINCOLN		Very Long Nose		1 Narrow, 1 Wide
AUTO & HANSEN 1/2				4 Narrow

## TOMCO BRAND

ARO Coupler

Industrial Interchange Coupler

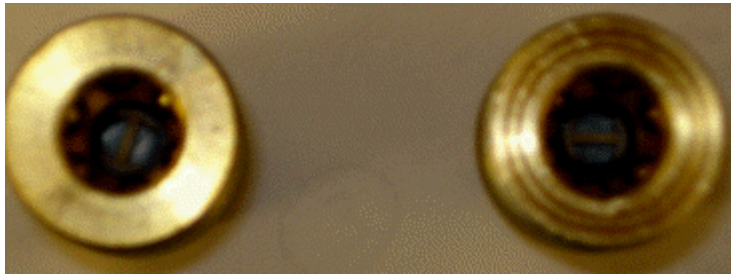

No rings on face

2 rings on face

- Plugs are identified the same way as the Amflo brand.
- 1/2" Tru-Flate & Industrial Interchange are the same.

## REFERENCE

J&B No.	Amflo No.	J&B No.	Amflo No.	J&B No.	Amflo No.
21032	C21	22743	C10	22762	C26-44
21033	CP21	22744	C20	25117	C37
21034	CP20	22747	C5-04	40936	CP10
22460	CP20-23	22749	CP5	40938	CP9-03
22462	CP21-03	22751	CP37	40985	CP25-02
22494	CP26	22752	CP38	40986	CP26-22
22495	CP25	22753	C38	40988	C26-22
22496	C26	22754	CP27	40996	CST4B
22497	C25	22755	CP28	40997	CPST3B
22499	C25-02	22756	C28	40998	CST6B
22502	C9	22760	C-40	41001	CPST5B
22742	CP17	22761	CP25-44		



# COUPLERS & PLUGS

## FEATURES & BENEFITS

- These couplers and plugs have no valves.
- Smooth straight-thru bore allows maximum flow.
- Made from solid brass bar stock. Couplers have stainless steel springs and balls.
- Excellent for carpet cleaners, vacuum service and pressure washers.
- Interchanges with Parker ST type.

## STRAIGHT-THRU SERIES



J&B #	STYLE	THREAD TYPE	BODY SIZE	NPT SIZE	MATERIAL	PSI	QTY
40996	COUPLER	FEMALE	1/4"	1/4"	BRASS	5200	EA
40994	COUPLER	MALE	1/4"	1/4"	BRASS	5200	EA
40997	PLUG	MALE	1/4"	1/4"	BRASS	5200	EA
40958	PLUG	FEMALE	1/4"	1/4"	BRASS	5200	EA
40998	COUPLER	FEMALE	3/8"	3/8"	BRASS	2700	EA
41001	PLUG	MALE	3/8"	3/8"	BRASS	2700	EA
40959	PLUG	FEMALE	3/8"	3/8"	BRASS	2700	EA



# CRIMPING TOOL

## MODEL 855 HOSE CRIMPER

*Model 855 Hose Crimper provides production capability and "big tool" crimping advantages at just a fraction of the cost of other tools offering comparable results.*

- **RUGGED CONSTRUCTION** - High strength ductile iron casting. Five hardened steel ribbed dies included.
- **SELF-CONTAINED** - All dies in place, ready for instant use. (No separate dies to lose or misplace.)
- **PORTABLE** - Carry it to the job, or mount on workbench as desired.
- **ONE-HAND OPERATION** - Gives tremendous leverage by positive camming action at end of lever stroke.

AMF 855 Crimper with 5 dies for 1/4"  
1-braid through 3/8" - 2-braid hose.

AMF 855A Same as 855, except largest die is  
replaced by 7/16" die for crimping 3/16" hose.  
(Welding hoses, etc.)

Special dies up to 13/16" (1/2" I.D. hose) available.



\* Please allow two weeks for delivery of crimping tool.

## HOSE FERRULES

J&B #	FITS HOSE	FITS J&B HOSE	QTY
38246	1/2" OD		25
38247	9/16" OD		25
38248	19/32" OD		25
38249	5/8" OD		25
38250	21/32" OD		25
38251	11/16" OD		25
38252	23/32" OD	24826	25
38253	3/4" OD		25
38256	7/8" OD		25
38258	15/16" OD	24832	25
38259	1" OD	50412	25



# BLOW GUNS

---

## HIGH VOLUME BLOW GUN Typhoon Pro



- Variable flow control for precise air delivery.
- Lightweight aluminum body with a rugged, chrome-plated zinc high flow nozzle.
- Chrome plating on a aluminum body resists chemicals & solvents and makes gun easy to clean. . Can also be disassembled for easy maintenance & internal cleaning.
- Silicone-free so ideal for use in paint applications.

J&B #	L x W x H	WT.	QTY
V41936	10.5" x 5.75" x 2.125"	12 oz	EA

---

## BLOW GUN EXTENSION



- 24" extension with chrome plated high flow tip.

J&B #	LENGTH	QTY
V41934	24"	EA

# BLOW GUNS

---

## SAFETY BLOW GUN

- Tip pressure will not exceed 30 PSI, yet gives good blast of air for cleaning.
- Molded body fits the hand properly, has convenient hang-up hook. Simple, dependable design gives years of trouble-free service.
- Plated steel control lever is riveted to body - cannot loosen.

J&B #	QTY
38425	EA

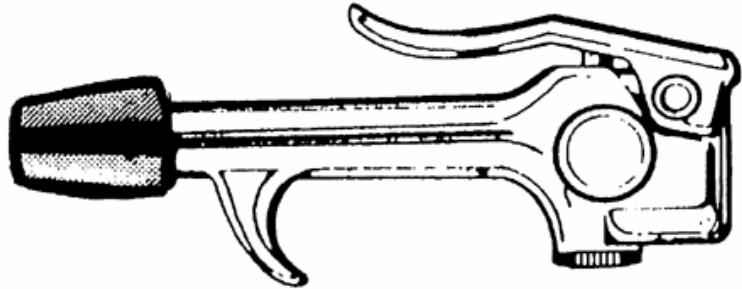

**NOTE:** Safety Air Blow Guns are equipped with a safety by-pass which prevents build up of tip pressure in the event the blow gun tip is obstructed or "dead ended". They comply with the requirements of OSHA 1910.242b and 1910.95, when used on air lines of 175 PSI or less.

---

## FULL FLOW BLOW GUN

- Molded body fits the hand properly, has convenient hang-up hook. Simple, dependable design gives years of trouble-free service.
- Plated steel control lever is riveted to body - cannot loosen.

J&B #	QTY
38424	EA

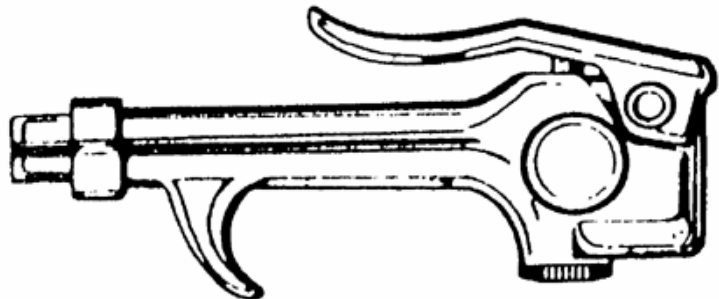

**CAUTION:** Blow Guns do not have a safety by-pass provision to prevent build-up of tip pressure in the event of tip blockage. They may be used for cleaning purposes only if the air supply (inlet pressure) has been reduced to 30 PSI or less.

# GREASE FITTINGS

## 1/4-28 TAPER THREAD

- Ball check in head.
- Pressure rating: 10,000 PSI.



J&B#	DESCRIPTION	LENGTH	QTY
20655	45° LONG	29/32	25
20656	90° SHORT	3/4	25
20653	SHORT	35/64	50
20647	LONG	11/16	25
20654	EXTRA LONG	31/32	25

## 1/8" PIPE THREAD

- Ball check in head.
- Pressure rating: 1,000 PSI.

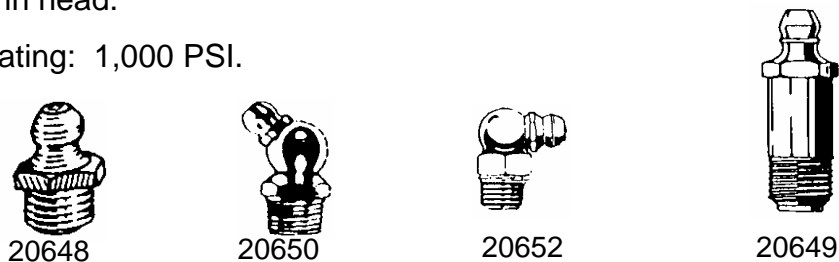

J&B #	DESCRIPTION	LENGTH	QTY
20648	STRAIGHT	11/16	50
20649	STRAIGHT	1-1/4	25
20650	45°	29/32	25
20652	90°	27/32	25

## 1/4" TAPER PIPE THREAD

- Ball check in head.
- Pressure rating: 1,000 PSI.

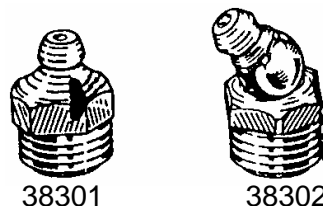

J&B #	DESCRIPTION	LENGTH	QTY
38301	STRAIGHT	59/64	25
38302	67-1/2°	1-1/16	25



# GREASE FITTINGS

## METRIC

- Ball check in head.
- Pressure rating: 10,000 PSI.



J&B #	DESCRIPTION	SIZE	QTY
25048	STRAIGHT	6 MM x 1.00	25
25049	45°	6 MM x 1.00	25
25050	90°	6 MM x 1.00	25
25051	STRAIGHT	8 MM x 1.00	25
25052	45°	8 MM x 1.00	25
25092	90°	8 MM x 1.00	25
40403	STRAIGHT	8 MM x 1.25	25
25053	STRAIGHT	10MM x 1.00	25
40365	45°	10MM x 1.00	25
25054	90°	10MM x 1.00	25

## DRIVE TYPE

- Ball check in head.
- Pressure rating: 1,000 PSI.

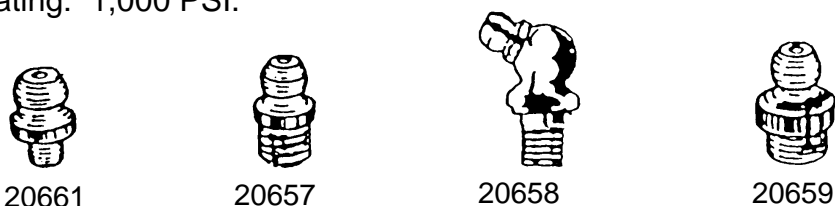

J&B #	DESCRIPTION	SIZE	QTY
20661	STRAIGHT	3/16	25
20657	STRAIGHT	1/4	25
20658	67-1/2°	1/4	25
20659	STRAIGHT	5/16	25

## BUTTON HEAD



J&B #	DESCRIPTION	SIZE	QTY
40366	STRAIGHT	1/8 PTF	10
40367	STRAIGHT	1/4 PTF	10

# GREASE ACCESSORIES

## HIGH PRESSURE GREASE HOSE 18" Whip Hose

- Working pressure 4800 PSI.
- Hose type: elastomeric.

J&B #	HOSE ID	FITTINGS ON ENDS	QTY
32340	3/16	1/8 NPT	EA

\* Use with hand operated guns only.



## HIGH PRESSURE GREASE HOSE 18" Whip Hose

- Working pressure 4500 PSI.
- Includes spring guard.

J&B #	HOSE ID	FITTINGS ON ENDS	QTY
42999	3/16	1/8 NPT	EA

\* Use with hand operated guns only.

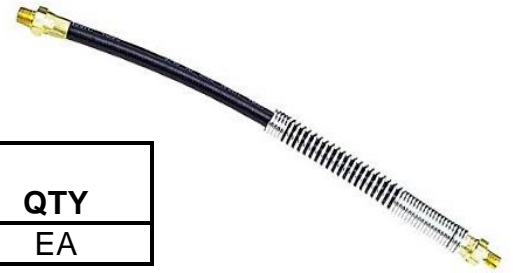

## MEDIUM PRESSURE GREASE HOSE 12" Whip Hose

- Working pressure 3000 PSI.

J&B #	HOSE ID	FITTINGS ON ENDS	QTY
20233	3/16	1/8 NPT	EA

\* Use with hand operated guns only.

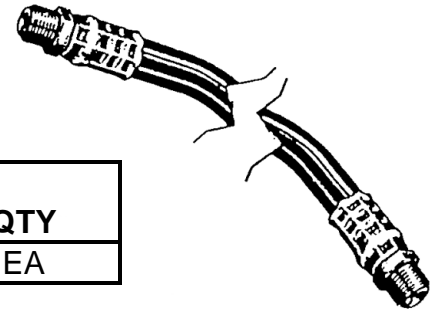

## GREASE FITTING CAP

- Made of low polyethylene.
- Snap over grease fittings to seal out grease & moisture.
- Fit standard grease fitting heads, with the exception of flush type, button heads and pin type.

J&B #	STRAP LENGTH	COLOR	QTY
59111	1/8"	RED	50



# GREASE ACCESSORIES

## LINCOLN HYD. COUPLER

- For use with all hydraulic type grease fittings.
- Has three hardened steel jaws and built in ball check.
- Lincoln part # 5852.



J&B #	THREAD	QTY
22763	1/8 NPT	5

## H/D GREASE COUPLER

- For use with all hydraulic type grease fittings.
- Has four hardened steel jaws and built in ball check.

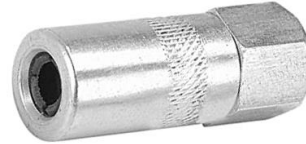

J&B #	THREAD	QTY
20162	1/8 NPT	EA

## REG GREASE COUPLER

- For ordinary working pressures only.



J&B #	THREAD	QTY
20028	1/8 NPT	EA

## GREASE ADAPTER

- 1/4-28 Taper thread male  
1/8 N.P.T. female



J&B #	QTY
20935	5

## LOCK N LUBE

- Locks on, does not leak. Rated up to 10,000 PSI.
- 1/8" NPT compatible with all grease guns.
- Grease goes in, not on, the machine.
- Works on all grease fittings, SAE and metric.
- World's original locking grease coupler.
- Easily releases from clogged grease fittings, even under pressure.



- 20080: longer design offers 3.6" effective reach.

J&B #	SIZE	QTY
20075	NORMAL	EA
20080	LONG	EA

# HOSE CLAMPS

## STANDARD BAND

- Band and housing are 201 stainless steel.
- 5/16" slotted hex head shouldered carbon screw, double plated with zinc plus dichromate-yellow.
- Four spot electronic weld (stronger than ordinary spot welds) firmly joins clamp band and housing.

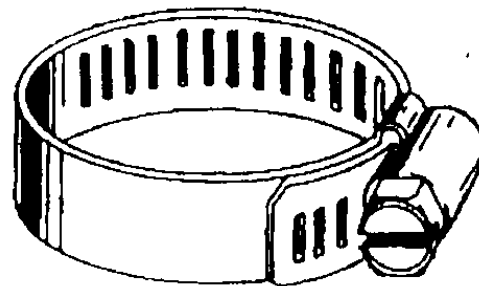

J&B #	IND #	FITS HOSE		CLAMP DIAMETER		QTY
		FROM	TO	MIN	MAX	
21066	MINI 4	1/4	3/8	7/32	5/8	10
20005	MINI 5			7/16	11/16	10
22288	MINI 6	3/8	1/2	7/16	25/32	10
21016	6	1/4	3/8	7/16	25/32	10
22541	8	3/8	5/8	1/2	29/32	10
21018	10	3/8	5/8	9/16	1-1/16	10
21987	HTR 12	5/8	3/4	11/16	1-1/4	10
21019	16	3/4	1	13/16	1-1/2	10
32108	20			13/16	1-3/4	10
21020	24	1-1/4	1-1/2	1-1/16	2	10
21067	28	1-1/4	1-3/4	1-5/16	2-1/4	10
21068	32	1-1/2	2	1-9/16	2-1/2	10
21069	36	1-3/4	2-1/4	1-13/16	2-3/4	10
21021	40	2	2-1/2	2-1/16	3	10
41380	44			2-5/16	3-1/4	10
22314	48	2-1/2	3	2-9/16	3-1/2	10
41382	52			2-13/16	3-3/4	10
21070	56	3-1/4	3-1/2	3-1/16	4	10
21023	64	3-3/4	4	3-9/16	4-1/2	10
21071	72			4-1/16	5	10
21026	88			5-1/16	6	10
40392	96			4-9/16	6-1/2	10
32109	104			6-1/16	7	10
32110	116			6-13/16	7-3/4	10
45340	152			7-1/2	10	10

\* MADE IN THE U.S.A.



# HOSE CLAMPS

## **\*\* ALL STAINLESS \*\*** **STANDARD BAND**

- Band & screw are all stainless.
- Marine grade high corrosion resisting stainless steel clamp necessary for marine, underground and other high corrosion applications.
- 4 piece interlock construction.

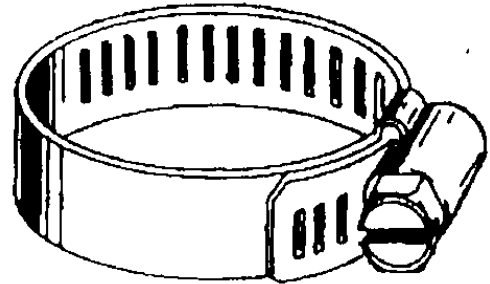

J&B #	IND #	FITS HOSE		CLAMP DIAMETER		QTY
		FROM	TO	MIN	MAX	
46800	MINI 4	1/4	3/8	7/32	5/8	10
46801	MINI 6	3/8	1/2	7/16	25/32	10
46802	6	1/4	3/8	7/16	25/32	10
46803	8	3/8	5/8	1/2	29/32	10
46804	10	3/8	5/8	9/16	1-1/16	10
46805	HTR 12	5/8	3/4	11/16	1-1/4	10
46806	16	3/4	1	13/16	1-1/2	10
46807	20			13/16	1-3/4	10
46808	24	1-1/4	1-1/2	1-1/16	2	10
46809	28	1-1/4	1-3/4	1-5/16	2-1/4	10
46810	32	1-1/2	2	1-9/16	2-1/2	10
46811	36	1-3/4	2-1/4	1-13/16	2-3/4	10
46812	40	2	2-1/2	2-1/16	3	10
46813	44			2-5/16	3-1/4	10
46814	48	2-1/2	3	2-9/16	3-1/2	10
46815	52			2-13/16	3-3/4	10
46816	56	3-1/4	3-1/2	3-1/16	4	10
46817	64	3-3/4	4	3-9/16	4-1/2	10

\* MADE IN THE U.S.A.

# HOSE CLAMPS

## EXTENDED "LINER" BAND

- Designed for silicone, E.P.D.M. & other soft hose.
- Integral extension of the band as a liner protects soft-surface hose from damage caused by extrusion or shearing through the band slots.
- Band and housing are 201/301 stainless steel.
- 5/16" slotted hex head shouldered screw, double plated with zinc plus dichromate-yellow.
- Four spot electronic weld (stronger than ordinary spot welds) firmly joins clamp band and housing.

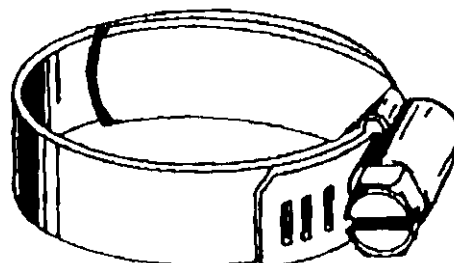

J&B #	IND #	FITS HOSE		CLAMP DIAMETER		QTY
		FROM	TO	MIN	MAX	
40585	6	1/4	3/8	7/16	25/32	10
40586	8	3/8	5/8	1/2	29/32	10
40587	10	3/8	5/8	5/8	1-1/16	10
40588	12	5/8	3/4	11/16	1-1/4	10
40589	16	3/4	1	13/16	1-1/2	10
40590	20			13/16	1-3/4	10
40591	24	1-1/4	1-1/2	1-1/16	2	10
40592	28	1-1/4	1-3/4	1-5/16	2-1/4	10
40593	32	1-1/2	2	1-9/16	2-1/2	10
40594	36	1-3/4	2-1/4	1-13/16	2-3/4	10
40595	40	2	2-1/2	2-1/16	3	10
40596	44			2-5/16	3-1/4	10
40597	48	2-1/2	3	2-9/16	3-1/2	10

## HOSE CLAMP ASSORTMENTS

J&B #	TYPE	CONTENTS	STORAGE
2126	STANDARD	5 EACH #4 THRU #36	H/D RACK
2172	STANDARD	5 EACH #4 THRU #36	DRAWER
2127	LINER	5 EACH #6 THRU #36	H/D RACK
2174	LINER	5 EACH #6 THRU #36	DRAWER

# HOSE CLAMPS

---

## CONSTANT-TORQUE HOSE CLAMPS

- A Belleville spring mechanism permits the Constant-torque clamp to automatically increase or decrease its own diameter due to changes in operational or environmental temperatures.
- This unique design eliminates “cold flow” leaks.
- Comes with extended liner which protects all types of hoses from damage & helps maintain consistent sealing pressure.
- Per SAE standard J1508 Type “SLHD”



J&B #	IND #	CLAMP DIAMETER		QTY
		MIN	MAX	
43000	10	9/16	1-1/16	EA
43001	12	11/16	1-1/4	EA
43002	16	13/16	1-1/2	EA
43003	20	13/16	1-3/4	EA
43004	24	1-1/16	2"	EA
42998	28	1-5/16	2-1/4	EA
43005	32	1-9/16	2-1/2	EA
43006	36	1-13/16	2-3/4	EA
43007	40	2-1/16	3"	EA
43008	44	2-5/16	3-1/4	EA
43009	48	2-9/16	3-1/2	EA

# HOSE CLAMPS

## TWO-EAR CLAMPS

- Can accommodate greater variation in hose size.
- A good choice for heavily vibrating equipment.
- Suitable for low-pressure hydraulic use.



J&B #	OETKER #	SIZE	DIAMETER	THICKNESS	QTY
45638	7	1/4	13/64 – 9/32	.015	50
45639	9	5/16	9/32 – 11/32	.031	50
45640	11	3/8	21/64 / 27/64	.031	50
45641	13	1/2	27/64 – 33/64	.031	50
45642	15	9/16	33/64 – 19/32	.031	25
45644	18	5/8	19/32 – 23/32	.031	25
45645	20	3/4	43/64 – 51/64	.047	25
45647	23	7/8	51/64 – 29/32	.047	25
45648	27	1"	29/32 – 1-1/16	.047	25

## SIDE-JAW Pincer

- Ideal for straight on and side clamping applications.

J&B #	QTY
45649	EA



## MINIATURE HOSE CLAMPS

Type "G"

- They grip 360 degrees around the Hose
- Zinc plated.



J&B #	HOSE I.D.	CLAMP RANGE	WIDTH	QTY
40905	1/4	10.5mm – 13mm 7/16 – 1/2	9MM (11/32)	10
40906	5/16	12.5mm – 15mm 1/2 – 19/32	9MM (11/32)	10
40907	3/8	13.5mm – 16mm 17/32 – 5/8	9MM (11/32)	10

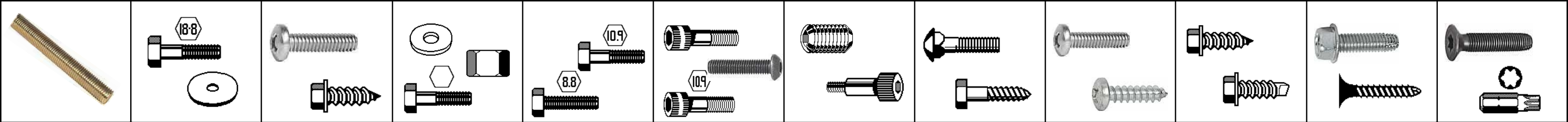























# J&B Fleet - Industrial Supply

www.jbfleet.com

22428 Harrisburg-Westville Rd. Alliance, Ohio 44601 Phone: (330) 821-6342 Fax: (330) 821-0411

**PART# 2888**

## COUPLERS & PLUGS 1/4 & 3/8

<p><b>40986</b> <sup>1</sup></p>  <p><b>1/4 PIPE 3/8 FEM PLUG</b></p> <p><sup>2</sup></p>	<p><b>40985</b> <sup>2</sup></p>  <p><b>1/4 PIPE 3/8 MALE PLUG</b></p> <p><sup>2</sup></p>	<p><b>22499</b> <sup>3</sup></p>  <p><b>1/4 PIPE 3/8 FEM COUPLER</b></p> <p><sup>2</sup></p>	<p><b>22761</b> <sup>4</sup></p>  <p><b>3/8 BARB 3/8 MALE PLUG</b></p> <p><sup>2</sup></p>	<p><b>40988</b> <sup>5</sup></p>  <p><b>1/4 PIPE 3/8 FEM COUPLER</b></p> <p><sup>2</sup></p>	<p><b>22761</b> <sup>6</sup></p>  <p><b>3/8 BARB 3/8 FEM COUPLER</b></p> <p><sup>2</sup></p>
<p><b>22494</b> <sup>7</sup></p>  <p><b>3/8 PIPE 3/8 FEM PLUG</b></p> <p><sup>2</sup></p>	<p><b>22495</b> <sup>8</sup></p>  <p><b>3/8 PIPE 3/8 MALE PLUG</b></p> <p><sup>2</sup></p>	<p><b>22497</b> <sup>9</sup></p>  <p><b>3/8 PIPE 3/8 FEM COUPLER</b></p> <p><sup>2</sup></p>	<p><b>21625</b> <sup>10</sup></p>  <p><b>1/4 BARB 1/4 MALE PLUG</b></p> <p><sup>2</sup></p>	<p><b>22744</b> <sup>11</sup></p>  <p><b>1/4 PIPE 1/4 FEM COUPLER</b></p> <p><sup>2</sup></p>	
<p><b>21034</b> <sup>13</sup></p>  <p><b>1/4 PIPE 1/4 FEM PLUG</b></p> <p><sup>2</sup></p>	<p><b>21033</b> <sup>14</sup></p>  <p><b>1/4 PIPE 1/4 MALE PLUG</b></p> <p><sup>2</sup></p>	<p><b>21032</b> <sup>15</sup></p>  <p><b>1/4 PIPE 1/4 FEM COUPLER</b></p> <p><sup>2</sup></p>	<p><b>42020</b> <sup>16</sup></p>  <p><b>3/8 BARB 1/4 MALE PLUG</b></p> <p><sup>2</sup></p>	<p><b>40984</b> <sup>17</sup></p>  <p><b>3/8 PIPE 1/4 FEM COUPLER</b></p> <p><sup>2</sup></p>	<p><b>22496</b> <sup>18</sup></p>  <p><b>3/8 PIPE 3/8 FEM COUPLER</b></p> <p><sup>2</sup></p>
<p><b>22460</b> <sup>19</sup></p>  <p><b>3/8 PIPE 1/4 FEM PLUG</b></p> <p><sup>2</sup></p>	<p><b>22462</b> <sup>20</sup></p>  <p><b>3/8 PIPE 1/4 MALE PLUG</b></p> <p><sup>2</sup></p>	<p><b>40987</b> <sup>21</sup></p>  <p><b>3/8 PIPE 1/4 FEM COUPLER</b></p> <p><sup>2</sup></p>	<p><b>21728</b> <sup>22</sup></p>  <p><b>1/4 BARB 1/4 FEM COUPLER</b></p> <p><sup>2</sup></p>	<p><b>42022</b> <sup>23</sup></p>  <p><b>3/8 BARB 1/4 FEM COUPLER</b></p> <p><sup>2</sup></p>	

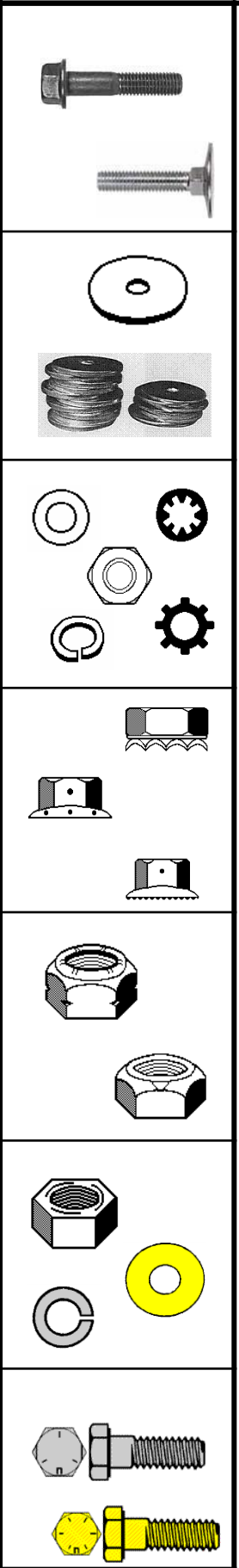



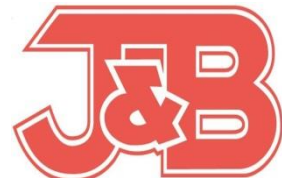
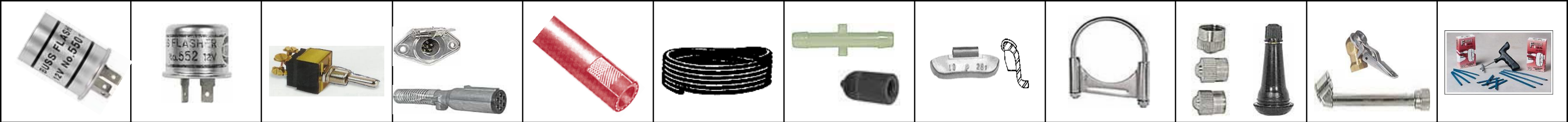









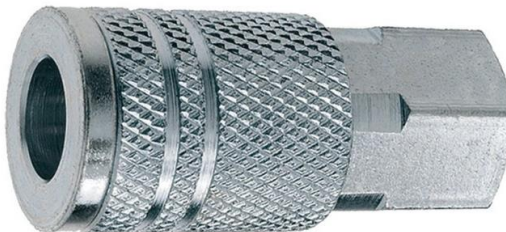

**PART# 2889**

**J&B Fleet - Industrial Supply**

22428 Harrisburg-Westville Rd. Alliance, Ohio 44601 Phone: (330) 821-6342 Fax: (330) 821-0411

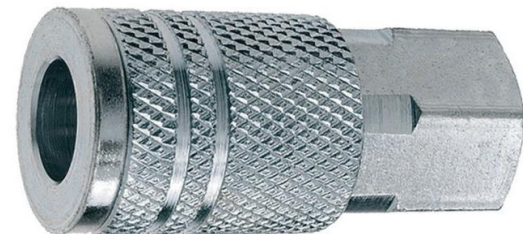
[www.jbfleet.com](http://www.jbfleet.com)

**COUPLERS & PLUGS 1/2**

<p><b>21626</b></p>  <p>2 <b>1/2 HOSE 1/2 PLUG</b></p>	<p><b>21627</b></p>  <p>2 <b>1/2 HOSE 1/2 COUPLER</b></p>	<p><b>21622</b></p>  <p>2 <b>3/8 PIPE 1/2 FEMALE COUPLER</b></p>	<p><b>21623</b></p>  <p>2 <b>3/8 PIPE 1/2 MALE COUPLER</b></p>
<p><b>21620</b></p>  <p>2 <b>3/8 PIPE 1/2 FEMALE PLUG</b></p>	<p><b>21621</b></p>  <p>2 <b>3/8 PIPE 1/2 MALE PLUG</b></p>	<p><b>22743</b></p>  <p>2 <b>1/2 PIPE 1/2 FEMALE COUPLER</b></p>	<p><b>22502</b></p>  <p>2 <b>1/2 PIPE 1/2 MALE COUPLER</b></p>
<p><b>21624</b></p>  <p>2 <b>1/2 PIPE 1/2 FEMALE PLUG</b></p>	<p><b>22742</b></p>  <p>2 <b>1/2 PIPE 1/2 MALE PLUG</b></p>		

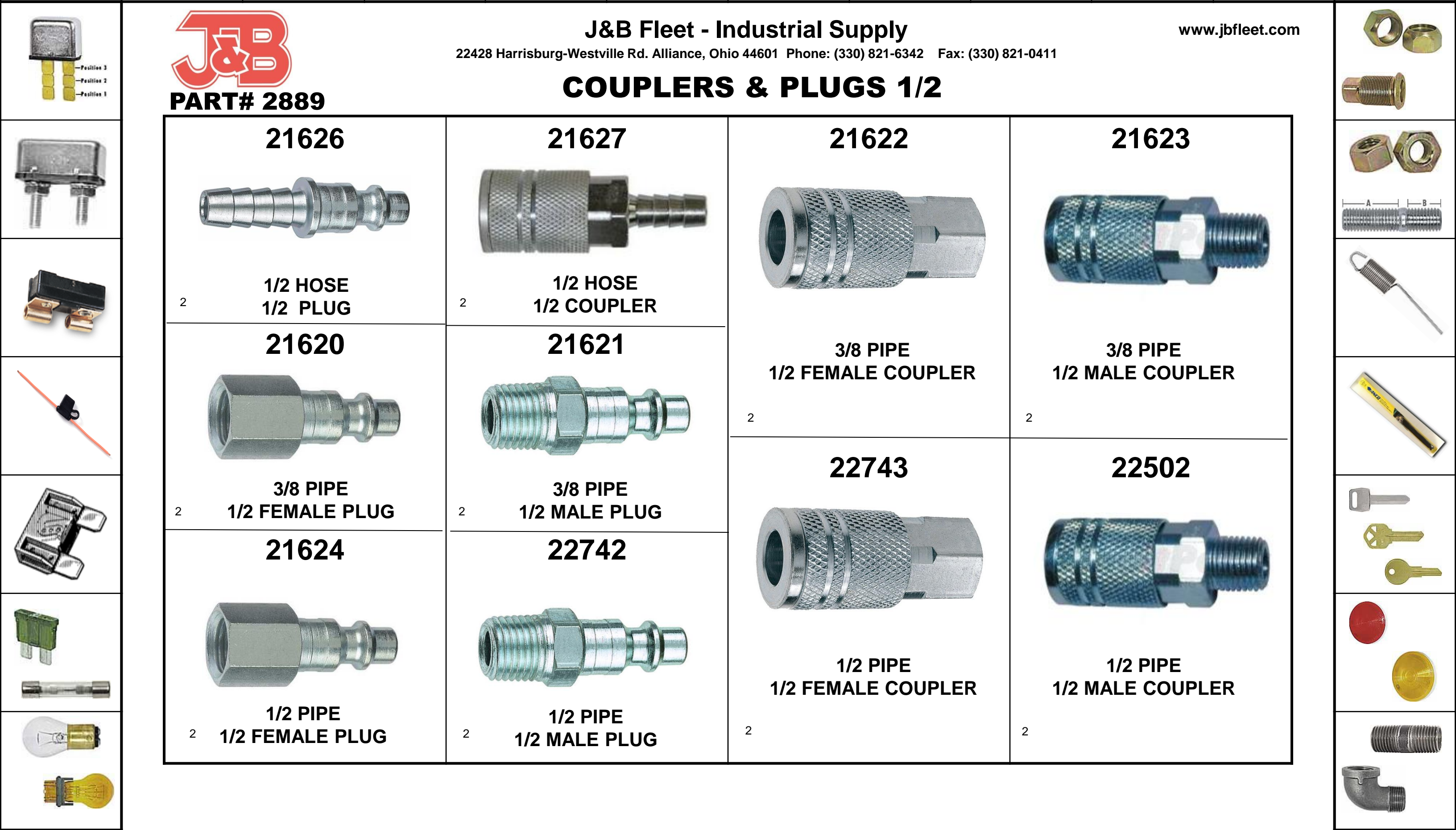



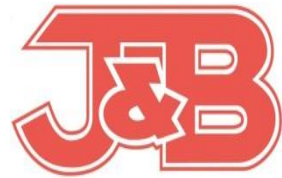













# J&B Fleet - Industrial Supply

www.jbfleet.com

22428 Harrisburg-Westville Rd. Alliance, Ohio 44601 Phone: (330) 821-6342 Fax: (330) 821-0411

## AUTOMOTIVE STANDARD SERIES 3/8"

PART # 2891

 <p><b>21732</b> 1 1/4 PIPE 3/8 FEMALE COUPLER</p>	 <p><b>21731</b> 2 3/8 PIPE 3/8 FEMALE COUPLER</p>	 <p><b>21633</b> 3 1/2 PIPE 3/8 FEMALE COUPLER</p>
 <p><b>21629</b> 4 1/4 PIPE 3/8 MALE COUPLER</p>	 <p><b>21631</b> 5 3/8 PIPE 3/8 MALE COUPLER</p>	 <p><b>22747</b> 6 1/2 PIPE 3/8 MALE COUPLER</p>
 <p><b>21628</b> 7 1/4 PIPE 3/8 FEMALE PLUG</p>	 <p><b>21630</b> 8 3/8 PIPE 3/8 FEMALE PLUG</p>	 <p><b>21632</b> 9 1/2 PIPE 3/8 FEMALE PLUG</p>
 <p><b>21730</b> 10 1/4 PIPE 3/8 MALE PLUG</p>	 <p><b>22749</b> 11 3/8 PIPE 3/8 MALE PLUG</p>	 <p><b>21729</b> 12 1/2 PIPE 3/8 MALE PLUG</p>



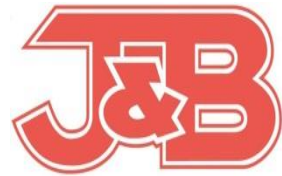

**PART # 2890**

**J&B Fleet - Industrial Supply**

22428 Harrisburg-Westville Rd. Alliance, Ohio 44601 Phone: (330) 821-6342 Fax: (330) 821-0411

[www.jbfleet.com](http://www.jbfleet.com)

**AUTOMOTIVE STANDARD SERIES 1/2"**

**40936**



**1/2 PIPE  
1/2 FEMALE PLUG**

2

**21635**



**1/2 PIPE  
1/2 MALE PLUG**

2

**22743**



**1/2 PIPE  
1/2 FEMALE COUPLER**

2

**22502**



**1/2 PIPE  
1/2 MALE COUPLER**

2

**21634**



**3/8 PIPE  
1/2 FEMALE PLUG**

2

**40938**



**3/8 PIPE  
1/2 MALE PLUG**

2

**21622**



**3/8 PIPE  
1/2 FEMALE COUPLER**

2

**21623**



**3/8 PIPE  
1/2 MALE COUPLER**

2

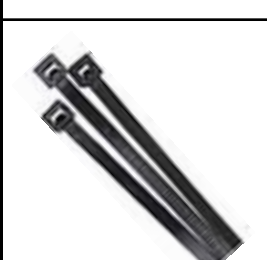
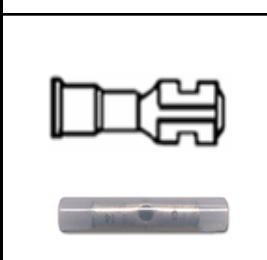



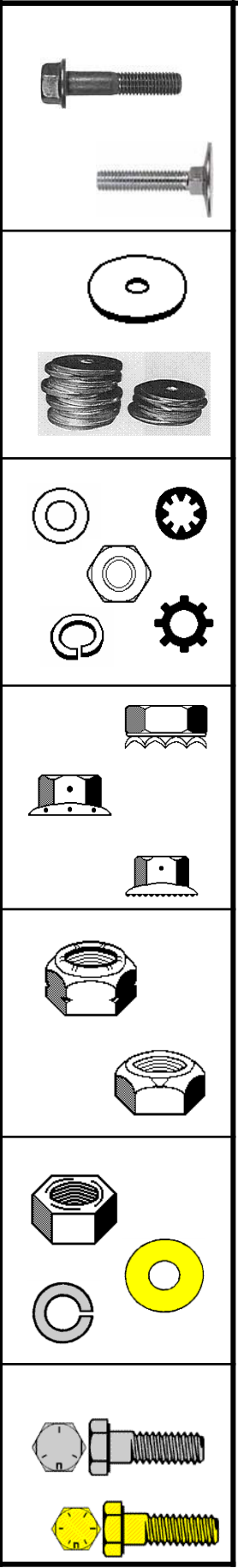
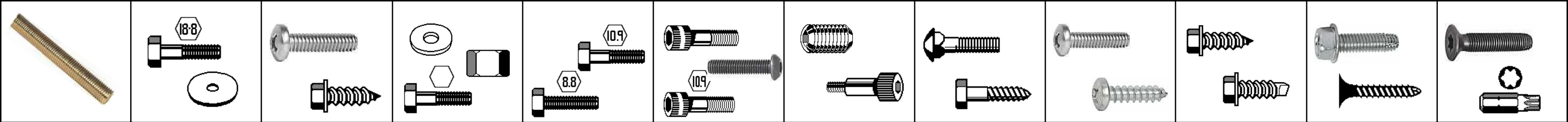

























**J&B Fleet - Industrial Supply**

22428 Harrisburg-Westville Rd. Alliance, Ohio 44601 Phone: (330) 821-6342 Fax: (330) 821-0411

[www.jbfleet.com](http://www.jbfleet.com)

**PART# 2123**

**HOSE BARB FITTINGS**

<p><b>22230</b> <sup>1</sup></p>  <p><b>3/16 HOSE MENDER</b></p> <p><sup>2</sup></p>	<p><b>22468</b> <sup>2</sup></p>  <p><b>1/4 HOSE MENDER</b></p> <p><sup>2</sup></p>	<p><b>32061</b> <sup>3</sup></p>  <p><b>5/16 HOSE MENDER</b></p> <p><sup>2</sup></p>	<p><b>22470</b> <sup>4</sup></p>  <p><b>3/8 HOSE MENDER</b></p> <p><sup>2</sup></p>	<p><b>32053</b> <sup>5</sup></p>  <p><b>1/2 HOSE MENDER</b></p> <p><sup>2</sup></p>	<p><b>32065</b> <sup>6</sup></p>  <p><b>1/4H - 1/8P</b></p> <p><sup>2</sup></p>
<p><b>22218</b> <sup>7</sup></p>  <p><b>1/8H - 1/8P</b></p> <p><sup>2</sup></p>	<p><b>22220</b> <sup>8</sup></p>  <p><b>3/16H - 1/8P</b></p> <p><sup>2</sup></p>	<p><b>32055</b> <sup>9</sup></p>  <p><b>1/4H - 1/8P</b></p> <p><sup>2</sup></p>	<p><b>21056</b> <sup>10</sup></p>  <p><b>1/4H - 1/4P</b></p> <p><sup>2</sup></p>	<p><b>32057</b> <sup>11</sup></p>  <p><b>1/4H - 3/8P</b></p> <p><sup>2</sup></p>	<p><b>32067</b> <sup>12</sup></p>  <p><b>3/8H - 1/4P</b></p> <p><sup>2</sup></p>
<p><b>32056</b> <sup>13</sup></p>  <p><b>5/16H - 1/4P</b></p> <p><sup>2</sup></p>	<p><b>32054</b> <sup>14</sup></p>  <p><b>3/8H - 1/8P</b></p> <p><sup>2</sup></p>	<p><b>32058</b> <sup>15</sup></p>  <p><b>3/8H - 1/4P</b></p> <p><sup>2</sup></p>	<p><b>32059</b> <sup>16</sup></p>  <p><b>3/8H - 3/8P</b></p> <p><sup>2</sup></p>	<p><b>32060</b> <sup>17</sup></p>  <p><b>3/8H - 1/2P</b></p> <p><sup>2</sup></p>	<p><b>32069</b> <sup>18</sup></p>  <p><b>1/2H - 3/8P</b></p> <p><sup>2</sup></p>
<p><b>38907</b> <sup>19</sup></p>  <p><b>1/2H - 1/4P</b></p> <p><sup>2</sup></p>	<p><b>38908</b> <sup>20</sup></p>  <p><b>1/2H - 3/8P</b></p> <p><sup>2</sup></p>	<p><b>38416</b> <sup>21</sup></p>  <p><b>1/2H - 1/2P</b></p> <p><sup>2</sup></p>	<p><b>22222</b> <sup>22</sup></p>  <p><b>5/8H - 1/2P</b></p> <p><sup>2</sup></p>	<p><b>22224</b> <sup>23</sup></p>  <p><b>3/4H - 1/2P</b></p> <p><sup>2</sup></p>	<p><b>38415</b> <sup>24</sup></p>  <p><b>3/4H - 3/4P</b></p> <p><sup>2</sup></p>

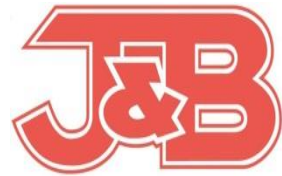





























# J&B Fleet - Industrial Supply

www.jbfleet.com

22428 Harrisburg-Westville Rd. Alliance, Ohio 44601 Phone: (330) 821-6342 Fax: (330) 821-0411

**PART # 2102**

## GREASE FITTINGS

 <p><b>25048</b> <sup>1</sup></p> <p>6 MM-1.00 STRAIGHT</p> <p><sup>3</sup></p>	 <p><b>25049</b> <sup>2</sup></p> <p>6 MM-1.00 45°</p> <p><sup>3</sup></p>	 <p><b>25050</b> <sup>3</sup></p> <p>6 MM-1.00 90°</p> <p><sup>2</sup></p>	 <p><b>25051</b> <sup>4</sup></p> <p>8 MM-1.00 STRAIGHT</p> <p><sup>2</sup></p>	 <p><b>25052</b> <sup>5</sup></p> <p>8 MM-1.00 45°</p> <p><sup>2</sup></p>	 <p><b>25092</b> <sup>6</sup></p> <p>8 MM-1.00 90°</p> <p><sup>2</sup></p>	 <p><b>25053</b> <sup>7</sup></p> <p>10 MM-1.00 STRAIGHT</p> <p><sup>2</sup></p>	 <p><b>40365</b> <sup>8</sup></p> <p>10 MM-1.00 45°</p> <p><sup>2</sup></p>
 <p><b>25054</b> <sup>9</sup></p> <p>10 MM-1.00 90°</p> <p><sup>2</sup></p>	 <p><b>20661</b> <sup>10</sup></p> <p>3/16 STRAIGHT DRIVE</p> <p><sup>3</sup></p>	 <p><b>20657</b> <sup>11</sup></p> <p>1/4 STRAIGHT DRIVE</p> <p><sup>3</sup></p>	 <p><b>20658</b> <sup>12</sup></p> <p>1/4 67-1/2 DRIVE</p> <p><sup>3</sup></p>	 <p><b>20659</b> <sup>13</sup></p> <p>5/16 STRAIGHT DRIVE</p> <p><sup>3</sup></p>	 <p><b>20935</b> <sup>14</sup></p> <p>1/4-28 MALE 1/8 PIPE FEMALE ADAPTER</p> <p><sup>2</sup></p>	 <p><b>40366</b> <sup>15</sup></p> <p>1/8 MPT BUTTON HEAD</p> <p><sup>1</sup></p>	 <p><b>40367</b> <sup>16</sup></p> <p>1/4 MPT BUTTON HEAD</p> <p><sup>1</sup></p>
 <p><b>20656</b> <sup>17</sup></p> <p>1/4-28 90</p> <p><sup>5</sup></p>	 <p><b>20655</b> <sup>18</sup></p> <p>1/4-28 45</p> <p><sup>5</sup></p>	 <p><b>20653</b> <sup>19</sup></p> <p>1/4-28 SHORT</p> <p><sup>10</sup></p>	 <p><b>20647</b> <sup>20</sup></p> <p>1/4-28 LONG</p> <p><sup>5</sup></p>	 <p><b>20654</b> <sup>21</sup></p> <p>1/4-28 EXTRA LONG</p> <p><sup>5</sup></p>	 <p><b>40403</b> <sup>22</sup></p> <p>8 MM-1.25 STRAIGHT</p> <p><sup>2</sup></p>	<p><sup>23</sup></p>	<p><sup>24</sup></p>
 <p><b>20652</b> <sup>25</sup></p> <p>1/8 MALE PIPE THREAD 90</p> <p><sup>3</sup></p>	 <p><b>20650</b> <sup>26</sup></p> <p>1/8 MALE PIPE THREAD 45</p> <p><sup>3</sup></p>	 <p><b>20648</b> <sup>27</sup></p> <p>1/8 MPT STRAIGHT</p> <p><sup>5</sup></p>	 <p><b>20649</b> <sup>28</sup></p> <p>1/8 MPT STRAIGHT LONG</p> <p><sup>2</sup></p>	<p><sup>29</sup></p>	<p><sup>30</sup></p>	 <p><b>38302</b> <sup>31</sup></p> <p>1/4 TAPER 67 1/2"</p> <p><sup>1</sup></p>	 <p><b>38301</b> <sup>32</sup></p> <p>1/4 TAPER STRAIGHT</p> <p><sup>1</sup></p>

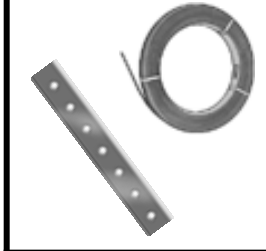





# J&B Fleet - Industrial Supply













22428 Harrisburg-Westville Rd. Alliance, Ohio 44601 Phone: (330) 821-6342 Fax: (330) 821-0411

www.jbfleet.com

PART # 2172

## HOSE CLAMPS (STANDARD)



<p>21066 <span style="float: right;">1</span></p>  <p><b>#4 (1/4 – 3/8 HOSE)</b></p> <p>5</p>	<p>21018 <span style="float: right;">5</span></p>  <p><b>#10 (3/8 – 5/8 HOSE)</b></p>	<p>32108 <span style="float: right;">8</span></p>  <p><b>#20 (1" – 1-1/4 HOSE)</b></p>	<p>21068 <span style="float: right;">11</span></p>  <p><b>#32 (1-1/2 – 2" HOSE)</b></p>
<p>22288 <span style="float: right;">2</span></p>  <p><b>#5 (3/8 – 1/2 HOSE)</b></p> <p>5</p>	<p>21987 <span style="float: right;">6</span></p>  <p><b>#12 HEATER (5/8 – 3/4 HOSE)</b></p>	<p>21020 <span style="float: right;">9</span></p>  <p><b>#24 (1-1/4 – 1-1/2 HOSE)</b></p>	<p>21069 <span style="float: right;">12</span></p>  <p><b>#36 (1-3/4 – 2-1/4 HOSE)</b></p>
<p>21016 <span style="float: right;">3</span></p>  <p><b>#6 (1/4 – 3/8 HOSE)</b></p> <p>5</p>	<p>21019 <span style="float: right;">7</span></p>  <p><b>#16 (3/4 – 1" HOSE)</b></p>	<p>21067 <span style="float: right;">10</span></p>  <p><b>#28 (1-1/4 – 1-3/4 HOSE)</b></p>	
<p>22541 <span style="float: right;">4</span></p>  <p><b>#8 (3/8 – 5/8 HOSE)</b></p> <p>5</p>			

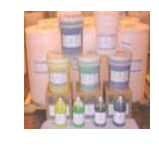



# J&B Fleet - Industrial Supply

22428 Harrisburg-Westville Rd. Alliance, Ohio 44601 Phone: (330) 821-6342 Fax: (330) 821-0411

www.jbfleet.com

PART # 2174

## HOSE CLAMPS (LINER)



<p><b>40585</b> 1</p>  <p>5 #6 (9/16 – 13/16 RANGE)</p>	<p><b>40588</b> 4</p>  <p>5 #12 (15/16 – 1-1/4 RANGE)</p>	<p><b>40591</b> 7</p>  <p>5 #24 (1-1/16 – 2" RANGE)</p>	<p><b>40593</b> 9</p>  <p>5 #32 (1-9/16 – 2-1/2 RANGE)</p>
<p><b>40586</b> 2</p>  <p>5 #8 (11/16 – 15/16 RANGE)</p>	<p><b>40589</b> 5</p>  <p>5 #16 (13/16 – 1-1/2 RANGE)</p>	<p><b>40592</b> 8</p>  <p>5 #28 (1-5/16 – 2-1/4 RANGE)</p>	<p><b>40594</b> 10</p>  <p>5 #36 (1-13/16 – 2-13/16 RANGE)</p>
<p><b>40587</b> 3</p>  <p>5 #10 (13/16 – 1-1/16 RANGE)</p>	<p><b>40590</b> 6</p>  <p>5 #20 (13/16 – 1-3/4 RANGE)</p>		

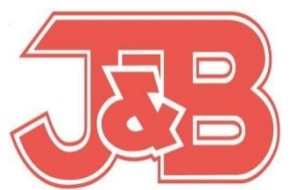
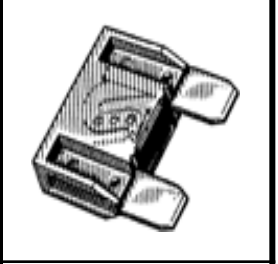
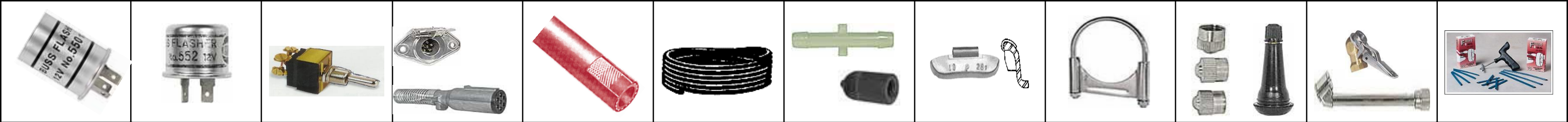



**PART# 2826**

**J&B Fleet - Industrial Supply**

22428 Harrisburg-Westville Rd. Alliance, Ohio 44601 Phone: (330) 821-6342 Fax: (330) 821-0411

[www.jbfleet.com](http://www.jbfleet.com)

**CONSTANT-TORQUE HOSE CLAMPS**

<p><b>43000</b></p>  <p><b>#10</b></p> <p>2</p>	<p><b>43003</b></p>  <p><b>#20</b></p> <p>2</p>	<p><b>43005</b></p>  <p><b>#32</b></p> <p>2</p>	<p><b>43007</b></p>  <p><b>#40</b></p> <p>1</p>
<p><b>43001</b></p>  <p><b>#12</b></p> <p>2</p>	<p><b>43004</b></p>  <p><b>#24</b></p> <p>2</p>	<p><b>43006</b></p>  <p><b>#36</b></p> <p>2</p>	<p><b>43008</b></p>  <p><b>#44</b></p> <p>1</p>
<p><b>43002</b></p>  <p><b>#16</b></p> <p>2</p>			

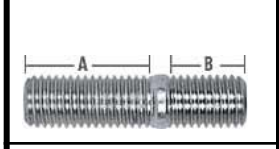

# HOSE CLAMP ASSORTMENTS

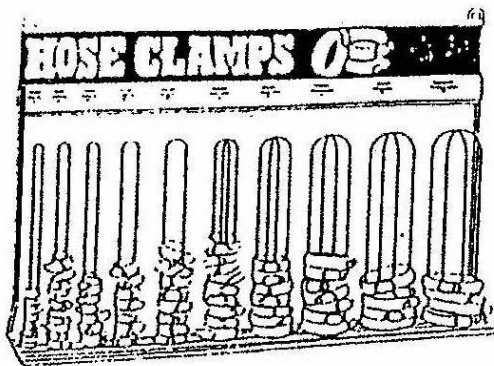

J&B #	TYPE	STORAGE
2126	STANDARD	H/D RACK

**Includes 5 clamps each of:**

- # 21066 - # 4    # 21019 - # 16
- # 22288 - # 5    # 32108 - # 20
- # 21016 - # 6    # 21067 - # 28
- # 21018 - # 10   # 21068 - # 32
- # 21987 - # 12   # 21069 - # 36

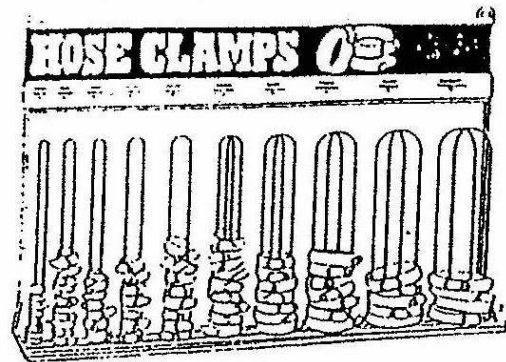
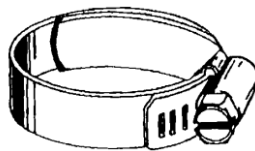

J&B #	TYPE	STORAGE
2127	LINER	H/D RACK

**Includes 5 clamps each of:**

- # 40585 - # 6    # 40590 - # 20
- # 40587 - # 10   # 40592 - # 28
- # 40588 - # 12   # 40593 - # 32
- # 40589 - # 16   # 40594 - # 36

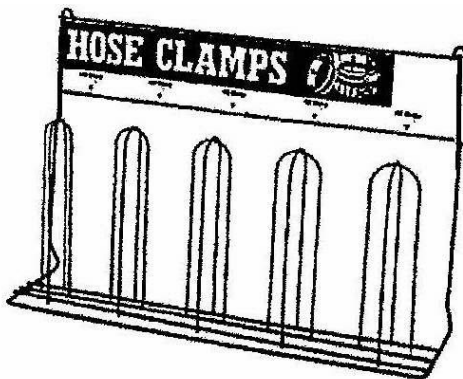

J&B #	TYPE	STORAGE
2136	STANDARD	H/D RACK

**Includes 5 clamps each of:**

- # 21021 - # 40   # 21070 - # 56
- # 22314 - # 48   # 21071 - # 72
- # 41382 - # 52

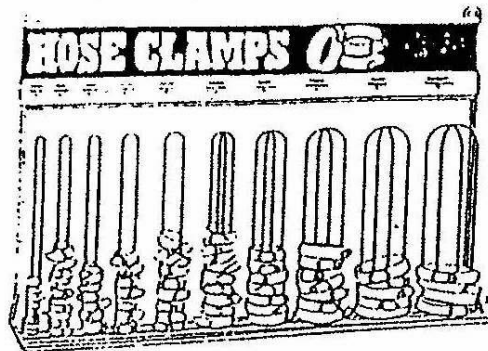
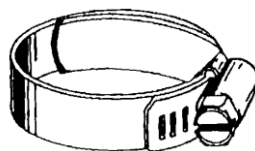

J&B #	TYPE	STORAGE
2274	STAINLESS	H/D RACK

**Includes 5 clamps each of:**

- # 46800 - # 4    # 46806 - # 16
- # 46802 - # 6    # 46807 - # 20
- # 46803 - # 8    # 46809 - # 28
- # 46804 - # 10   # 46810 - # 32
- # 46805 - # 12   # 46811 - # 36





# J&B Fleet - Industrial Supply









22428 Harrisburg-Westville Rd. Alliance, Ohio 44601 Phone: (330) 821-6342 Fax: (330) 821-0411

[www.jbfleet.com](http://www.jbfleet.com)

PART # 2276

## HOSE CLAMPS ALL STAINLESS



<p>1 <b>46800</b></p>  <p><b>#4 (1/4 - 3/8 HOSE)</b></p> <p>5</p>	<p>5 <b>46804</b></p>  <p><b>#10 (3/8 - 5/8 HOSE)</b></p>	<p>8 <b>46807</b></p>  <p><b>#20</b></p>	<p>11 <b>46810</b></p>  <p><b>#32 (1-1/2 - 2" HOSE)</b></p>
<p>2 <b>46801</b></p>  <p><b>#6 (3/8 - 1/2 HOSE)</b></p> <p>5</p>	<p>5 <b>46805</b></p>  <p><b>#12 HEATER (5/8 - 3/4 HOSE)</b></p> <p>6</p>	<p>9 <b>46808</b></p>  <p><b>#24 (1-1/4 - 1-1/2 HOSE)</b></p>	<p>5 <b>46811</b></p>  <p><b>#36 (1-3/4 - 2-1/4 HOSE)</b></p> <p>12</p>
<p>3 <b>46802</b></p>  <p><b>#6 (1/4 - 3/8 HOSE)</b></p> <p>5</p>	<p>5 <b>46806</b></p>  <p><b>#16 (3/4 - 1" HOSE)</b></p>	<p>10 <b>46809</b></p>  <p><b>#28 (1-1/4 - 1-3/4 HOSE)</b></p>	<p>5 <b>46811</b></p>  <p><b>#36 (1-3/4 - 2-1/4 HOSE)</b></p>
<p>4 <b>46803</b></p>  <p><b>#8 (3/8 - 5/8 HOSE)</b></p> <p>5</p>	<p>5 <b>46806</b></p>  <p><b>#16 (3/4 - 1" HOSE)</b></p>	<p>5 <b>46809</b></p>  <p><b>#28 (1-1/4 - 1-3/4 HOSE)</b></p>	<p>5 <b>46811</b></p>  <p><b>#36 (1-3/4 - 2-1/4 HOSE)</b></p>

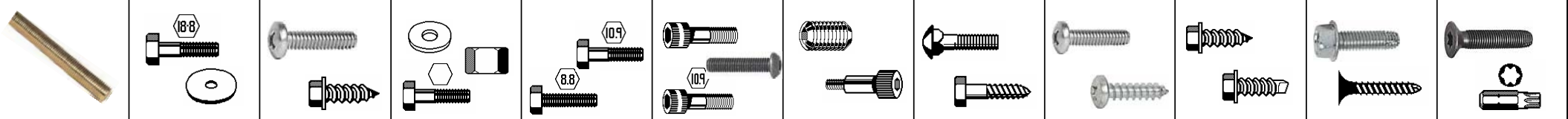

**J&B Fleet - Industrial Supply**













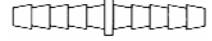

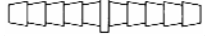
22428 Harrisburg-Westville Rd. Alliance, Ohio 44601 Phone: (330) 821-6342 Fax: (330) 821-0411

[www.jbfleet.com](http://www.jbfleet.com)

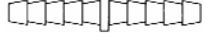
PART # 2205

**TWO-EAR CLAMPS & HOSE MENDERS**

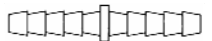

 <b>45638</b> 1 <b>TWO-EAR CLAMP</b> <b>1/4</b> 10	 <b>45642</b> 2 <b>TWO-EAR CLAMP</b> <b>9/16</b> 10	 <b>45648</b> 3 <b>TWO-EAR CLAMP</b> <b>1</b> 10	 <b>32053</b> 4 <b>HOSE MENDER</b> <b>1/2</b> 5
 <b>45639</b> 5 <b>TWO-EAR CLAMP</b> <b>5/16</b> 10	 <b>45644</b> 6 <b>TWO-EAR CLAMP</b> <b>5/8</b> 10	 <b>22468</b> 7 <b>HOSE MENDER</b> <b>1/4</b> 5	 <b>32061</b> 11 <b>HOSE MENDER</b> <b>5/16</b> 5
 <b>45640</b> 9 <b>TWO-EAR CLAMP</b> <b>3/8</b> 10	 <b>45645</b> 10 <b>TWO-EAR CLAMP</b> <b>3/4</b> 10	 <b>22470</b> 15 <b>HOSE MENDER</b> <b>3/8</b> 5	 <b>32061</b> 11 <b>HOSE MENDER</b> <b>5/16</b> 5
 <b>45641</b> 13 <b>TWO-EAR CLAMP</b> <b>1/2</b> 10	 <b>45647</b> 14 <b>TWO-EAR CLAMP</b> <b>7/8</b> 10	 <b>22470</b> 15 <b>HOSE MENDER</b> <b>3/8</b> 5	 <b>32061</b> 11 <b>HOSE MENDER</b> <b>5/16</b> 5

