

WIRE & CABLE

THERMOPLASTIC PRIMARY WIRE

Flat Two Conductor Copper Stranded

- **HEAVY DUTY** thermoplastic black and white insulated copper conductors. Gray plastic outer jacket.
- Wires laid parallel and covered with a high quality plastic jacket, oblong in shape.
- Jacket provides a compact cable and protects the insulated conductors against weather and acid conditions.
- Sizes 12 and 10 gauge are recommended for electric brake wire.
- Voltage rated at 60 volts or less. Temperature -22 F to 221 F.



J&B #	GAUGE	WIRE COLOR	QTY
*46140	10	Black / White	100'
*39430	12	Black / White	100'
39432	12	Black / White	500'
*41851	14	Black / White	100'
*39600	14	Black / White	500'
*46144	16	Black / White	100'
*46146	18	Black / White	100'

* NO BROKEN ROLLS (OK TO BREAK 39432
DOWN TO 25', 50' OR 250')

THERMOPLASTIC PRIMARY WIRE

Flat Three Conductor Copper Stranded

- **HEAVY DUTY** thermoplastic black, green and white insulated copper conductors. Gray plastic outer jacket.
- Wires laid parallel and covered with a high quality plastic jacket, oblong in shape.
- Jacket provides a compact cable and protects the insulated conductors against weather and acid conditions.
- Voltage rated at 60 volts or less. Temperature -22 F to 221 F.



J&B #	GAUGE	WIRE COLOR	QTY
*46431	12	Black / Green / White	100'
*46426	14	Black / Green / White	100'
*46428	16	Black / Green / White	100'

* NO BROKEN ROLLS

WIRE & CABLE

TRAILER CABLE

- Heavy duty, all weather **BLACK JACKET**.
- Color coded, insulated copper conductors bound with fiber filler and separator.
- Temperature rating of 80 C (176 F).

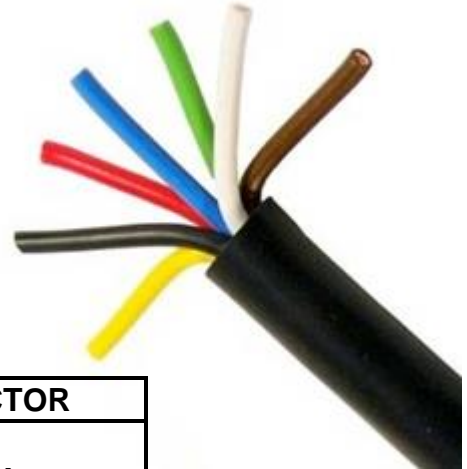

7 CONDUCTOR		4 CONDUCTOR	
(1)12 GA	(6)14 GA	(4)14 GA	
J&B #	QTY	J&B #	QTY
* 39433	100 FT	39540	25 FT
		39542	100 FT

* NO BROKEN ROLLS

AUTOMOTIVE WIRE

High Temperature
Cross-Link Polyethylene



- **Hi-temp**, thick wall, special purpose automotive wire is insulated with chemically cross-linked polyethylene.
- Withstands prolonged temperatures of up to **350°F** without melting or fusing.
- Insulation has a smooth surface finish.
- It is highly resistant to grease, oil, acids, brake fluid and abrasion.



J&B #	GAUGE	COLOR	QTY
*39435	14	BLACK	100'

* NO BROKEN ROLLS

WIRE & CABLE

FLEX-GARD CONVOLUTED LOOM

Polyethylene - Black

- Flex-gard convoluted loom holds groups of wires in position and gives the wires excellent protection against abrasion and crushing.
- It is slit for easy insertion of wires, yet the slit remains basically closed when the loom is bent or twisted.
- Temperature range: -40° to +200°F.

J&B #	SIZE	QTY
*40610	1/4"	150' RL
*40612	3/8"	100' RL
*40613	1/2"	100' RL
*40615	3/4"	50' RL
*40617	1"	25' RL
*40619	1-1/2"	20' RL

* No broken boxes

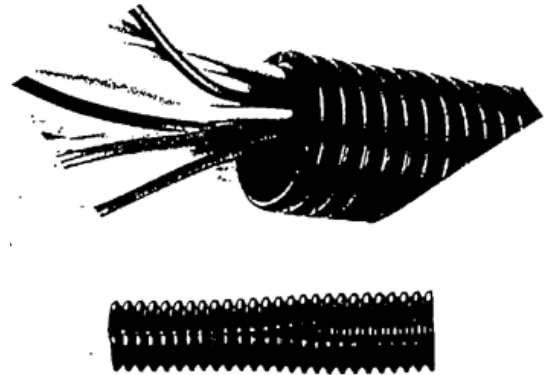

SPEAKER WIRE

- Two strand 22 gauge, grey plastic, **RIP-TYPE** wire.
- Used specifically for connecting speakers in automotive and truck equipment, industrial plants and homes.

J&B #	QTY
22593	250' ROLL

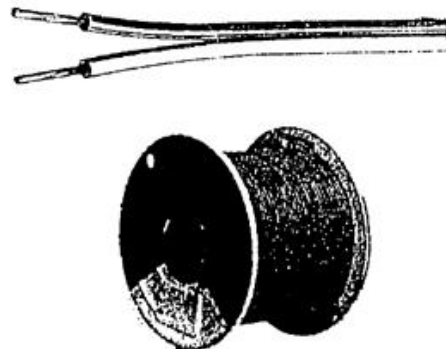

HOSE

TRANSMISSION OIL COOLER

- Special hose for circulating transmission fluid at high temperatures.
- Tube and cover are designed to meet OEM and SAE J1532 requirements.
- Features a polyester reinforcement for high burst protection.
- Resistant to fuel, ozone, oil, grease and heat aging.

J&B #	I.D.	COLOR	LENGTH
21140	5/16	BLACK	25'
21141	3/8	BLACK	25'



Construction

Tube: Nitrile

Reinforcement: Polyester

Cover: Nitrile/PVC

Temperature Resistance -30 F to +257 F.

HOSE

RED PREMIUM THERMAL HEATER HOSE 4 Spiral Polyester

- A blue insulating layer helps to minimize heat loss. Four spiral reinforcement for extra strength.
- A replacement for OE hose on most cars and light trucks.
- The high quality hose is similar to SAE20R3 Class D2, SAE J2387 for higher underhood temperatures.
- Resists weathering to provide a long, trouble-free service life.
- Withstands the abuse of corrosive solutions and additives.
- Temperature range = -40 F + 257 F (Not for steam use)

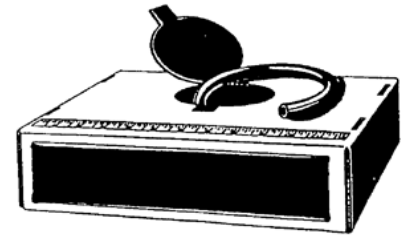

J&B #	I. D.	COLOR	LENGTH
21120	5/8"	RED	50'
21121	3/4"	RED	50'
21122	1"	RED	50'

- All heater hose packed in sturdy dispenser carton. Keeps hose fresh and clean.

SILICONE HEATER HOSE Super-Sil

- Meets or exceeds SAE20R3 HT Class A, and GM 6149 specifications.
- A silicone rubber tube, spiraled aramid fiber, and silicone rubber cover complete the construction.
- It was developed for high temperature resistance to oils, coolants, ozone, and cooling system additives.
- Reinforcement is 2 spiral polyester yarn.
- Temperature range = -65 F + 350 F



J&B #	I. D.	LENGTH
46310	5/8"	25'
46311	3/4"	25'
46312	1 "	25'

- All heater hose packed in sturdy dispenser carton. Keeps hose fresh and clean.

HOSE

BLACK OEM HEATER HOSE 2 Spiral Polyester

- A replacement for OE hose on most cars and light trucks.
- The high quality hose is similar to SAE20R3 Class D2, SAE J2387 for higher underhood temperatures.
- Resists weathering to provide a long, trouble-free service life.
- Withstands the abuse of corrosive solutions and additives.
- Temperature range = -40 F + 257 F (Not for steam use)

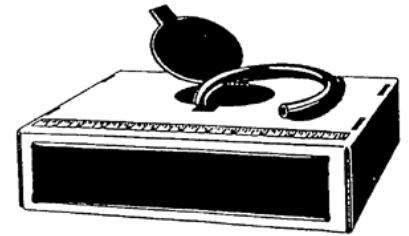
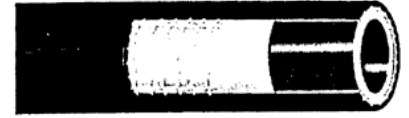

J&B #	I. D.	COLOR	LENGTH
21132	5/8"	BLACK	50'
21136	3/4"	BLACK	50'
21137	1"	BLACK	50'

- All heater hose packed in sturdy dispenser carton. Keeps hose fresh and clean.

BLACK STANDARD HEATER HOSE 2 Spiral Polyester

- A replacement for hose on most cars and light trucks.
- This standard grade hose is similar to SAE20R3 for normal duty service.
- Resists weathering to provide a long, trouble-free service life & withstands abuse of corrosive solutions & additives.
- Temperature range = -40 F + 212 F (Not for steam use)



J&B #	I.D.	COLOR	LENGTH
38738	1/2"	BLACK	50'

- All heater hose packed in sturdy dispenser carton. Keeps hose fresh and clean.

HOSE

FUEL INJECTION HOSE

- Constructed with low permeation elastomer liner.
- Durable outer cover resistant to abrasion, oil, grease, Ozone & coolants.
- -30°F to + 300°F. Meets SAE J30R9.
- Compatible with gasoline, E85 flex-fuel, ethanol extended gasoline, diesel, bio-diesel & lubrication oils.



J&B #	HOSE I.D.	BURST PRESSURE P.S.I.	WORKING PRESSURE P.S.I.	QTY
42170	1/4"	900	100	10'
42171	5/16"	900	100	10'
42172	3/8"	900	100	10'
42173	1/2"	900	100	10'

FUEL LINE HOSE

- Neoprene cover **resists** deterioration from oil, grease, and ozone and gives long service life.
- Meets all federal safety standards and regulations requiring fuel line hose to have one braid.



J&B #	HOSE I.D.	MAX WORK PRESSURE P.S.I.	MIN BURST PRESSURE P.S.I.	MIN. BEND RADIUS	QTY
21692	1/4"	40	175	2-1/2	25'
21693	5/16"	40	175	2-3/4	25'
21694	3/8"	40	175	3	25'



TUBE CUTTER

- Easy to use tool that can cut all types of plastic or rubber tube & pipe up to 1-5/8", 42 mm outside diameter.
- Includes a X-Cel blade which is a quick change, reversible blade that equals 2 times blade life.
- No ratcheting or twisting required.
- Cutter has spring loaded handles for faster positioning.



J&B #	QTY
50317	EA

FUEL LINE CONNECTORS

ORIGINAL EQUIPMENT

Quick Connectors



- Fuel line quick connectors are a press fit. Clamps not required.

****No broken packs****

J&B #	TYPE	(A)	(B)	QTY
FM2964	90 ELBOW	5/16	8mm(5/16)	2
FM2972	90 ELBOW	3/8	8mm(5/16)	2
FM2971	90 ELBOW	3/8	10mm	2
FM2965	STRAIGHT	5/16	8mm(5/16)	2
FM2966	STRAIGHT	3/8	8mm(5/16)	2
FM2967	STRAIGHT	3/8	10mm	2
FM2973	STRAIGHT	1/4	8mm(5/16)	2
FM2979	STRAIGHT	5/16	8mm(5/16)	2
FM2978	STRAIGHT	3/8	10mm	2
FM3153C	90 ELBOW	5/16	8mm(5/16)	2
FM3155C	90 ELBOW	5/16	10mm	2
FM3154C	90 ELBOW	3/8	10mm	2

FUEL LINE MEDIC

Quick Connectors

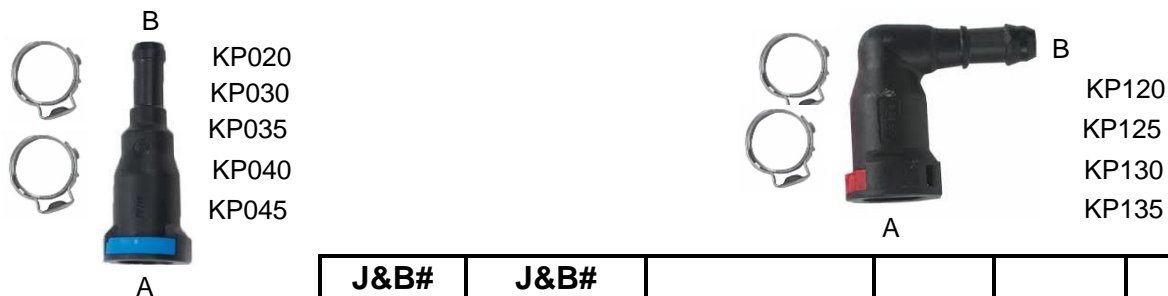

- Fuel line quick connectors are a press fit. 2 Clamps are included.

****No broken packs****

J&B# SUR&R	J&B# FMSI	TYPE	(A)	(B)	QTY
KP045	FM3403C	STRAIGHT	1/4	5/16	2
KP040	FM3394C	STRAIGHT	5/16	5/16	2
KP035	FM3393C	STRAIGHT	5/16	3/8	2
KP030		STRAIGHT	3/8	5/16	2
KP020	FM3391C	STRAIGHT	3/8	3/8	2
	FM3395C	STRAIGHT	10mm	10mm	2
KP135	FM3397C	90 ELBOW	5/16	5/16	2
KP120	FM3392C	90 ELBOW	5/16	3/8	2
KP130		90 ELBOW	3/8	5/16	2
KP125	FM3390C	90 ELBOW	3/8	3/8	2

FUEL ATTACHING HARDWARE

360 DEGREE SEAL CLAMPS

- Positive 360 degree seal with no gaps on the inside of the clamp.
- Smooth inner band prevents damage to the tube or hose.



J&B #	SIZE	I.D.	APPLICATION	QTY
FM2940	7.0 mm	9/32	6mm – 1/4" nylon fuel lines	10
FM2950	8.7 mm	11/32	8mm – 5/16 nylon fuel lines	10
FM2980	9.5 mm	3/8	8mm – 5/16 nylon fuel lines	10
FM2981	10.5 mm	13/32	3/8" nylon fuel line	10
FM2982	11.3 mm	7/16	10mm – 3/8" nylon fuel lines	10
FM2983	12.3 mm	15/32	Fuel, transmission & coolant hose	10
FM2984	13.3 mm	1/2	Fuel, transmission & coolant hose	10
FM2985	14.5 mm	9/16	Fuel, transmission & coolant hose	10
FM2986	15.7 mm	5/8	1/4" shop air line	10
FM2987	17.0 mm	11/16	3/8" shop air line	10
FM2988	18.5 mm	23/32	3/8" shop air line	10
FM3227	19.8 mm	25/32	Fuel, transmission & coolant hose	10
FM2989	21.0 mm	13/16	Fuel, transmission & coolant hose	10
FM2990	24.1 mm	15/16	Use with FMSI# 4204 (5/8")	10
FM2991	25.6 mm	1	Fuel, transmission & coolant hose	10
FM2995	28.6 mm	1-1/8	Use with FMSI# 4205 (3/4")	10

* SOLD IN FULL BOXES OF 10 CLAMPS ONLY

NYLON FUEL LINE RING BARB



J&B #	DESCRIPTION	QTY
FM2994	1/4" (6mm)	2
FM2959	5/16" (8mm)	2
FM2968	10mm	2

* SOLD IN FULL BOXES OF 2 ONLY

CONVOLUTED NYLON REPAIR LINES

J&B #	TUBE O.D	LENGTH	QTY
FM2962CVT	5/16 (8mm)	10"	EA
FM2963CVT	10mm	10"	EA

GM TANK SENDER HOSE LINE FITTINGS



J&B #	DESCRIPTION	QTY
FM4236	16mm x 1.5	EA
FM4237	14mm x 1.5	EA

NYLON FUEL LINE REDUCER



J&B #	DESCRIPTION	QTY
FM3204	1/4 to 5/16 (8mm)	2
FM3205	5/16 (8mm) to 3/8	2

* SOLD IN FULL BOXES OF 2 ONLY

STEEL FUEL REPAIR LINES

STEEL TO NYLON ADAPTER LINES

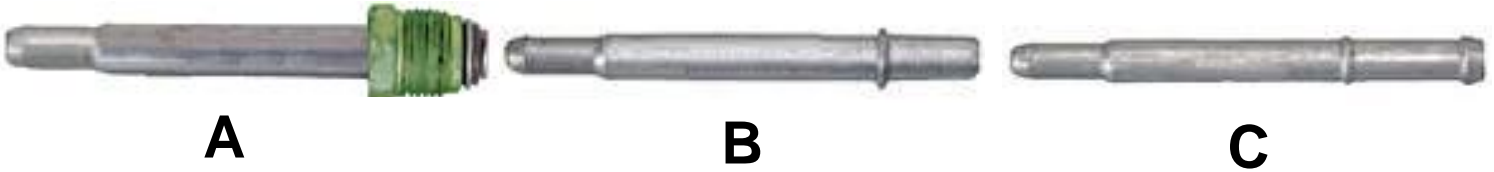

J&B #	SIZE	TYPE	APPLICATION	QTY
FM3118	5/16 x 3-3/4	B	For quick connector Ford/GM/Chrysler. (use with 5/16" (8mm) nylon tube)	2
FM3119	5/16 x 3-3/4	A	14mm fitting GM. (use with 5/16" nylon tube)	2
FM3119L	5/16 x 6"	A	14mm fitting GM. (use with 5/16" nylon tube)	2
FM3120	3/8 x 3-3/4	A	16mm fitting GM (use with 3/8" nylon tube)	2
FM3121	3/8 x 3-3/4	C	Hose end Ford/GM/Chrysler. (use with 3/8" nylon tube)	2
FM3122	5/16 x 3-3/4	C	Hose end Ford/GM/Chrysler. (use with 5/16" nylon tube)	1
FM3133	3/8 x 3-3/4	C	Hose end Ford/GM/Chrysler. (use with 10mm nylon tube)	2
FM3134	3/8 x 3-3/4	B	For quick connector Ford/GM/Chrysler. (use with 10mm nylon tube)	2
FM3135	3/8 x 3-3/4	A	16mm fitting GM (use with 10mm nylon tube)	2
FM3135L	3/8 x 6"	A	16mm fitting GM (use with 10mm nylon tube)	2

* SOLD IN FULL BOXES ONLY

SENDING UNIT REPAIR LINES



J&B #	SIZE	FITTINGS	QTY
FM3075	5/16 x 4-3/4	GM 14mm Fitting	EA
FM3074	3/8 x 4-3/4	GM 16mm Fitting	EA

J&B #	SIZE	FITTINGS	QTY
FM3073L	5/16 x 4-3/4	For quick connect	EA
FM3072L	3/8 x 4-3/4	For quick connect	EA

DOMESTIC STEEL FUEL REPAIR LINES



J&B #	SIZE	FITTINGS	QTY
FM3181	5/16 x 6"	GM 14mm Fitting	EA
FM3180	3/8 x 6"	GM 16mm Fitting	EA

TRANSMISSION REPAIR LINE



J&B #	SIZE	QTY
FM4511	3/8 x 4" ridge bead	EA

HARDWARE

FLEX LINE RETAINER CLIP



J&B #	QTY
FM3011	10

* SOLD IN FULL BOXES ONLY

FUEL INJECTION HOSE CLAMPS



J&B #	SIZE	QTY
FMF110	10mm – 12mm	10

* SOLD IN FULL BOXES ONLY

TRANSMISSION QUICK CONNECTOR RETAINER CLIP



J&B #	SIZE	QTY
FM4246	3/8	2
FM4247	1/2	2
FM4248	5/8	2

* SOLD IN FULL BOXES ONLY

FUEL LINE RETAINER CLIP



J&B #	SIZE	QTY
FM3107	5/16 Ford Transmission line	2

* SOLD IN FULL BOXES ONLY

GENERAL MOTORS FUEL LINE VITON O-RINGS



J&B #	SIZE	QTY
FM2881	5/16 fuel (return) line 14mm fitting	25
FM2880	3/8 fuel (filter) line 16mm fitting	25

* SOLD IN FULL BOXES ONLY

VACUUM PRODUCTS

WINDSHIELD WASHER & VACUUM TUBING

- Flexible & non collapsible.
- Oil & heat resistant; compression proof.
- Temperature rating: -40° to +257°F.
- Use with connectors below.



J&B #	I. D.	FITS	COLOR	LENGTH
20952	3/32"	1/8" CONN	BLACK	50'
20911	7/64"	1/8" CONN	BLACK	50'
20912	5/32"	3/16" CONN	BLACK	50'
20913	7/32"	1/4" CONN	BLACK	50'
20953	9/32"	5/16" CONN	BLACK	50'

HOSE CONNECTORS High-Density Polyethylene

UNION



J&B #	SIZE	QTY
20857	1/8	10
20858	3/16	10
20859	1/4	10
20860	5/16	10
20864	3/8	10

TEE



J&B #	SIZE	QTY
20867	5/32	10
20868	3/16	10
20869	1/4	10
32336	5/16	10
32337	3/8	10

REDUCERS



J&B #	SIZE	QTY
20865	1/4 x 3/16	10
20866	3/8 x 1/4	10

3-WAY UNIVERSAL BREAK-OFF TEE

- Provides up to **15** different size combinations for connecting various diameters of hose.
- Dual-grip serrations for positive leak-proof connections.
- **Not for use in fuel line.**

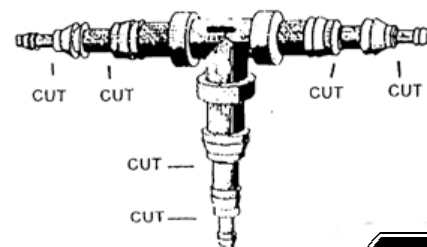

J&B #	SIZES	QTY
21329	1/8, 1/4, or 3/8	5/BX



VACUUM PRODUCTS

SEE PAGES 667 & 668 FOR NYLON TUBING

VACUUM CONNECTORS

- Withstands the higher underhood temperatures.
- Made of heat & chemical resistant **rubber**.
- For use on heater/A.C. vacuum systems & emission control systems.

J&B #	O.E.M. NUMBER	TYPE	A INCH/mm	B INCH/mm	QTY
40510	25517507	1	.110/2.85	.160/4.14	15
40512	12047609	1	.130/3.40	.230/5.50	15
40516	14084916	2	.135/3.43	.150/3.80	15
40517	12059749	2	.150/3.80	.220/5.59	15

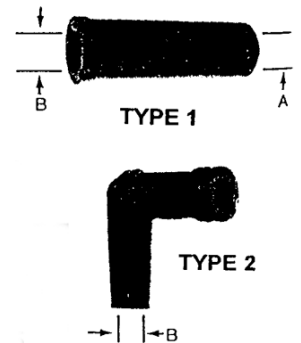

RUBBER CAPS

- Used for capping lines and hoses while testing carburetors, emission control systems, vacuum lines, etc.



J&B #	TUBE O.D.	INSIDE LENGTH	QTY
32332	1/8	.56	25
11597	3/16	.56	10
11596	1/4	.56	10
32333	5/16	.60	10
32334	3/8	.875	10
32335	1/2	.6875	10
32338	5/8	.875	10

BATTERY PRODUCTS

BATTERY CABLE

General Purpose

- Copper stranded conductor, with a smooth vinyl plastic insulation, resistant to abrasion, weather, oil and acids.
- Temperature rating of 176 def F.
- Built to S.A.E. specification J-1127.

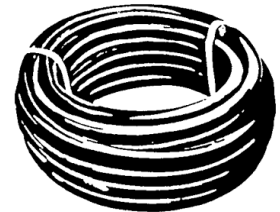

*** SOLD IN 25 FT ROLLS ONLY

BLACK			
J&B #	GAUGE	O.D.	QTY
38914	6	.330	25 FT
38930	4	.380	25 FT
38400	2	.410	25 FT
38404	1	.490	25 FT
38931	1/0	.550	25 FT
38932	2/0	.605	25 FT
38933	3/0	.695	25 FT

RED			
J&B #	GAUGE	O.D.	QTY
38401	6	.330	25 FT
38935	4	.380	25 FT
38403	2	.410	25 FT
38913	1	.490	25 FT
38936	1/0	.550	25 FT
38937	2/0	.605	25 FT

WELDING CABLE

- High stranding & EPDM jacket for greater cold weather flexibility.
- Rated at 105 C (221 F).
- Rated to 600 volts.
- Excellent abrasion & chemical resistance.
- Nominal low temp rating of -50 C (-58 F).

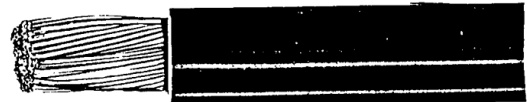

J&B #	GAUGE	COLOR	O.D.	QTY
38911	4/0	RED	.725	25 FT
38919	4/0	BLACK	.725	25 FT

**** FOR BLACK ONLY.....Welding cable comes in 25 foot rolls. 50 foot and 100 foot rolls are available if specified. Cannot order in any other lengths.**

BATTERY PRODUCTS

SOLDER PELLETS

- Fast method for attaching battery lug to cable.

J&B #	GAUGE	COLOR	QTY
56978	4	gray	10
56979	2	green	10
56980	1	red	10
56981	1/0	black	10
56982	2/0	orange	10
56983	3/0	purple	10
56984	4/0	yellow	10



SOLDER FLUX

Liquid solder flux is a chemical that serves several essential purposes for soldering battery cables and terminals. The liquid flux removes oxidation buildup in copper and solder. The oxidation buildup removal is done by the liquid solder flux to assist the metals during their bonding process. Liquid flux also reduces surface tension which allows the solder to flow more free and evenly along the surface of the application. Apply liquid flux when soldering for sturdy and clean solder joints.



2 Oz.

- Use one drop of liquid flux on the stripped copper wire to assist in your connection.
- Large cable sizes will require a few additional drops of liquid flux.
- If you are working in a confined space, wear protective eye gear when using liquid flux.

J&B #	QTY
56993	EA

BATTERY TERMINALS

BATTERY TERMINALS

3-WAY TOP POST



J&B #	WIRE SIZE	TYPE	QTY
*20172	6 to 1 GA	POSITIVE	5

HEAVY DUTY TOP POST UNIVERSAL

- Designed for heavy duty use - truck, construction, industrial, farm, etc.



J&B #	WIRE SIZE	QTY
38942	2 to 4/0 GA	5

H/D SIDE UNIVERSAL

- For batteries using side terminals.



J&B #	WIRE SIZE	QTY
38939	4-2/0 GA	EA

UNIVERSAL



J&B #	WIRE SIZE	QTY
20167	6 to 1 GA	5

UNIVERSAL LEAD FREE BATTERY TERMINAL



J&B #	WIRE SIZE	QTY
55797	4 & 6 GA	5

UNIVERSAL BATTERY TERMINALS



J&B #	WIRE SIZE	QTY
21319	6 to 1 GA	10

BATTERY TERMINALS

H/D CAST COPPER CRIMP TERMINALS Tin Plated

- One piece, cast copper construction provides **greater conductivity** and less voltage drop.
- Can be crimped or soldered.
- Long barrel gives added strength and vibration resistance.
- Uniform wall thickness assures high reliability.
- Cable size is clearly designated on terminals to ensure correct size selection.
- Polarity shown to avoid mixing positive/negative connections which could destroy battery.

STRAIGHT CLAMP

J&B #	WIRE SIZE	TYPE	QTY
39150	4 GA	UNIV	5
39151	1/0	POS	5
39152	1/0	NEG	5
39153	2/0	POS	5
39154	2/0	NEG	5
39155	3/0	POS	5
39156	3/0	NEG	5
39162	4/0	POS	4
39163	4/0	NEG	4

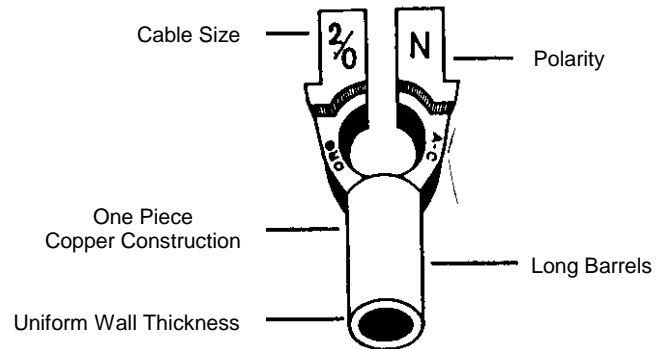

* Supplied with battery bolt & nut

RIGHT ELBOW

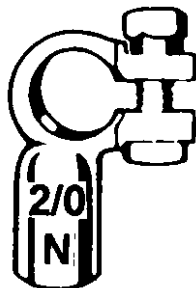

J&B #	WIRE SIZE	TYPE	QTY
39160	2/0	POS	5
39161	2/0	NEG	5

* Supplied with battery bolt & nut

FLAG TERMINAL

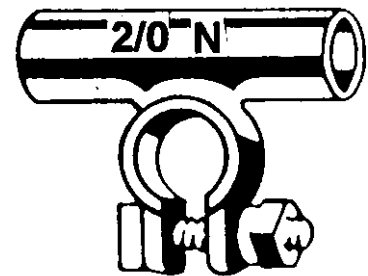

J&B #	WIRE SIZE	TYPE	QTY
39165	2/0	POS	4
39166	2/0	NEG	4

* Supplied with battery bolt & nut

BATTERY TERMINALS

H/D CAST COPPER CRIMP TERMINALS Tin Plated

- Designed for threaded stud or side terminal batteries.
- Stackable for multiple battery hook-ups.
- Locking teeth "**bite**" into battery terminal for non-rotating connection.
- Different cable gauges can be stacked, for example: 2/0 gauge cable between batteries and 4/0 gauge cable to starter or ground.
- Cable size and polarity designated on terminal.

STACKABLE TERMINALS END TERMINAL

J&B #	SIZE	TYPE	QTY
39402	2/0	UNIV	5
39403	3/0	UNIV	5



BATTERY STUD & TERMINAL COVER

- Battery post and terminal cover protects the battery stud/post, battery terminal and cable from corrosion and other harmful debris.
- Provides a finished and professional look.
- Prolongs cable life.

J&B #	SIZES	STUD	COLOR	QTY
41780	2-2/0 GA	3/8	RED	5
41781	2-2/0 GA	3/8	BLACK	5
41782	2/0-3/0 GA	3/8	RED	5
41783	2/0-3/0 GA	3/8	BLACK	5



BATTERY TERMINALS

EXTRA HEAVY DUTY COPPER LUGS

Seamless Copper (Tin Plated)



- Thicker walls for greater strength and conductivity.
- Used for severe-duty applications. Tin-plated copper. Stackable.
- Gauge stamped on lug for easy identification. Can be crimped or soldered.

LUGS

J&B #	WIRE SIZE	STUD SIZE	INDUSTRY COLOR	QTY
40488	6 GA	1/4	BLUE	5
40489	6 GA	5/16	BLUE	5
40490	6 GA	3/8	BLUE	5
40491	4 GA	1/4	GREY	5
40492	4 GA	5/16	GREY	5
40493	4 GA	3/8	GREY	5
40487	1-2 GA	5/16	PINK	5
40180	1-2 GA	3/8	PINK	5
40186	1/0	3/8	BLACK	5
40188	1/0	1/2	BLACK	5
40190	2/0	3/8	ORANGE	5
40192	2/0	1/2	ORANGE	5
40195	3/0	3/8	PURPLE	5
40196	3/0	1/2	PURPLE	5
40197	4/0	3/8	YELLOW	5
40198	4/0	1/2	YELLOW	5

SPLICES

J&B #	WIRE SIZE	INDUSTRY COLOR	QTY
40518	8 GA	RED	5
40519	6 GA	BLUE	5
40160	4 GA	GREY	5
40162	2 GA	PINK	5
40166	1/0	BLACK	5
40168	2/0	ORANGE	5
40170	3/0	PURPLE	5
40172	4/0	YELLOW	5



BATTERY TERMINALS

BATTERY CABLE LUGS

Seamless Copper

- Heavy duty closed end crimpable lugs designed for industrial, diesel, and marine applications.
- Manufactured from the highest grade electrolytic copper for **maximum conductivity**.
- All lugs are clearly marked with wire gauge for easy identification.

J&B #	WIRE SIZE	STUD SIDE	QTY
55809	8 GA	1/4	10
55810	8 GA	5/16	10
55811	8 GA	3/8	10
55812	8 GA	1/2	10
55813	6 GA	1/4	10
55814	6 GA	5/16	10
55815	6 GA	3/8	10
55816	6 GA	1/2	10
55817	4 GA	1/4	10
55818	4 GA	5/16	10
20476	4 GA	3/8	10
55819	4 GA	1/2	10
55824	2 GA	1/4	10
55825	2 GA	5/16	10
20477	2 GA	3/8	10
55826	2 GA	1/2	10
55820	1 GA	1/4	10
55821	1 GA	5/16	10
55822	1 GA	3/8	10
55823	1 GA	1/2	10
55806	1/0	1/4	10
55827	1/0	5/16	10
22190	1/0	3/8	10
55807	1/0	1/2	10
55828	2/0	1/4	10
55829	2/0	5/16	10
20478	2/0	3/8	10
20479	2/0	1/2	10
20481	3/0	3/8	10
22196	3/0	1/2	10
40016	4/0	3/8	10
40018	4/0	1/2	10



CRIMPING TOOLS

HEX CRIMPING TOOL Heavy Duty

- Designed for **heavy duty** battery terminals.
- Crimps all battery terminals, copper lugs and splices (8 GA - 4/0 GA).
- Puts **even** pressure on the terminal and wire, resulting in the best connection.
- Adjustable crimp dies permanently attached.
- Die settings have letter, number, and color codes.
- Insulated grips for comfort and safety.

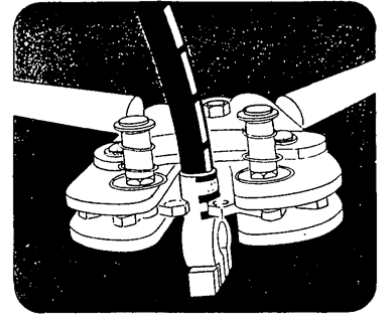

J&B #	QTY
41058	EA

CRIMPING TOOL

- Crimps 8 Ga. - 4/0 Ga. terminals.
- Use with hammer or vise.
- Crimping scale on side of tool prevents under-crimping.
- Spring loaded pin locks in 'up' position for loading terminal and cable. Pin is then released to hold terminal securely during crimping.

J&B #	QTY
39172	EA



BATTERY PRODUCTS

BATTERY ACCESSORIES

BATTERY BOLT

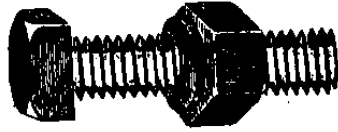

J&B #	SIZE	QTY
10572	5/16-18 x 1-3/8	25

BATTERY HOLD-DOWN BOLT



J&B #	SIZE	QTY
38972	5/16-18 x 12	10

SIDE TERMINAL BOLT

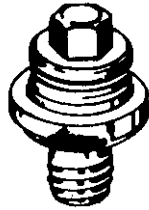

J&B #	SIZE	QTY
38938	3/8-16	10

HOLD-DOWN NUTS

Stainless Steel



J&B #	STYLE	HEAD	THREAD	QTY
39404	CLOSED	9/16	3/8-16	5
39281	OPEN	9/16	3/8-16	10

CABLE CUTTER

- Cuts all copper cable thru 4/0.
- Made of high quality **forged** steel.
- Cushion grip handles.

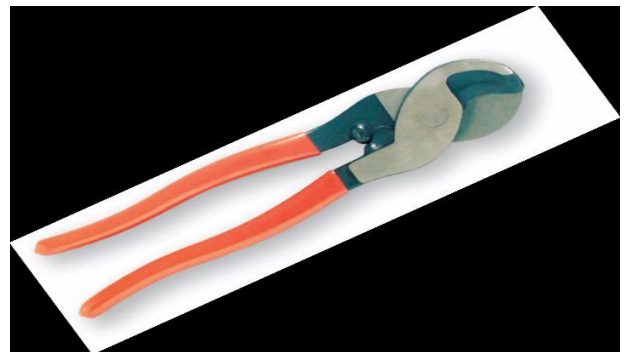

J&B #	QTY
39170	EA

BATTERY PRODUCTS

BATTERY TERMINAL PROTECTORS

- Terminal protectors are **impregnated** with a corrosion preventative formula that will not dry, evaporate, or crack due to temperature changes.
- Stops corrosion causing acid fumes from escaping at the battery post by forming a perfect seal, eliminating voltage drop or battery discharge.
- Can be used on both positive and negative terminals.

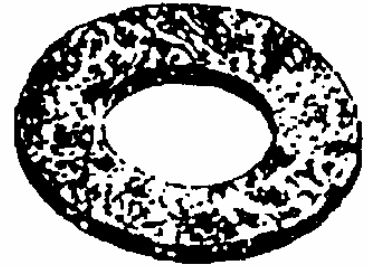

J&B #	TYPE	QTY
38740	TOP MOUNT	50/CN
38742	SIDE MOUNT	50/CN

TOP MOUNT TERMINALS

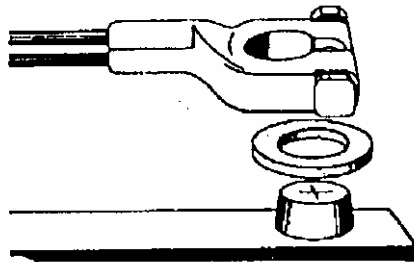

SIDE MOUNT TERMINALS

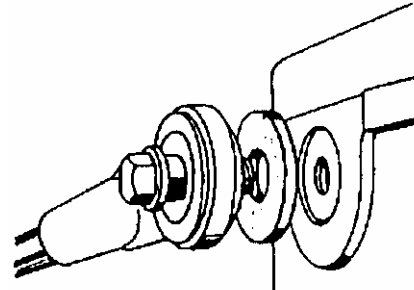

TERMINAL CLEANER

- This cleaner is shaped to fit snugly inside a battery cable terminal for removal of corrosion.
- The special shaped metal brush in the base fits over battery posts for quick cleaning and shaping.

J&B #	QTY
38941	EA



CLIPS & CLAMPS

HEAVY DUTY BATTERY CABLE CLAMPS 600 Amp

- Clamp is rated for over 600 amps.
- Handles are vinyl coated.

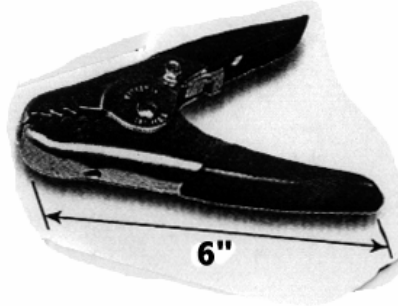

J&B #	COLOR	DESC.	QTY
38500	RED	600 AMP	EA
38501	BLACK	600 AMP	EA

MINIATURE BATTERY CLAMPS 50 Amp



J&B #	COLOR	DESC.	QTY
42080	RED	50 AMP	EA
42082	BLACK	50 AMP	EA

ALIGATOR CLIP

- 1-11/16" long, 5/16 jaw spread screw connection.







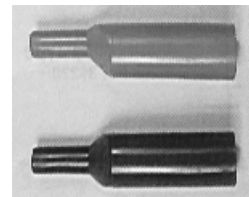











J&B #	QTY
28463	5/BX













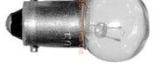

ALIGATOR CLIP INSULATOR

















J&B #	COLOR	QTY
22456	RED	5/BX
22457	BLACK	5/BX













MINIATURE BULBS

J&B #	IND.#	QTY	
40954	K2-2 Krypton	10	
38300	PR2	10	
38988	24	10	
38989	37	10	
38962	E37	10	
21164	53	10	
20896	57	10	
20898	67	10	
21145	73	10	
20903	PC74	10	
21170	89	10	
38985	97	10	
21146	147	10	
20904	168	10	
20905	PC168	10	
21147	193	10	

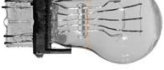

J&B #	IND.#	QTY	
20937	194	10	
21165	194A	10	
20906	PC194	10	
20585	211	10	
20907	327	10	
20908	456	10	
38979	561	10	
20909	623	10	
38986	906	10	
20914	912	10	
20915	916	10	
20916	916A	10	
20917	921	10	
40965	922	10	
21167	1003	10	

MINIATURE BULBS

J&B #	IND.#	QTY	
20918	1004	10	
20901	1073	10	
40955	1141	10	
40956	1142	10	
20511	1156	10	
20919	1156NA	10	
20902	1157	10	
20518	1157A	10	
22076	1157NA	10	
38525	1816	10	
21148	1819	10	
20921	1892	10	
38478	1893	10	
20922	1895	10	
21168	2057	10	

J&B #	IND.#	QTY	
20923	2057NA	10	
20924	2357	10	
20925	2357NA	10	
40950	2358 (3057)	10	
40952	2359 (3157)	10	
20926	3057NA (3057A)	10	
38987	3156	10	
20927	3156NA	10	
20928	3157NA	10	
20929	3456LL	10	
20930	3457 (3357)	10	
20931	3457NA (3357NA)	10	
40951	3757AK	10	
40957	3898	10	

MINIATURE BULBS

J&B #	IND.#	QTY	
20932	4157LL	10	
20933	4157NALL (4157NA)	10	
20934	7440	10	
21149	7443	10	
20936	9004	1	
20938	9004LL	1	
20939	9005	1	
21152	9005XSLL	1	
20900	9006XSLL	1	
21150	9006	1	
20940	9007LL	1	
20941	H1155 LL	1	

J&B #	IND.#	QTY	

BULB CABINET

- 32 clear, rugged plastic trays.



J&B #	SIZE	QTY
20942	19" W 26-3/4" H 4" D	EA

FUSES

GLASS TUBE FUSES

J&B #	INDUSTRY NO.	SIZE	QTY
20048	AGC 1 amp	1/4 x 1-1/4	5
20070	AGC 2 amp	1/4 x 1-1/4	5
20052	AGC 3 amp	1/4 x 1-1/4	10
20067	AGC 5 amp	1/4 x 1-1/4	10
42702	AGC 7-1/2 amp	1/4 x 1-1/4	10
20055	AGC 10 amp	1/4 x 1-1/4	10
20056	AGC 15 amp	1/4 x 1-1/4	10
21262	AGC 20 amp	1/4 x 1-1/4	10
20068	AGC 25 amp	1/4 x 1-1/4	10
20057	AGC 30 amp	1/4 x 1-1/4	10
20063	SFE 14 amp	1/4 x 1-1/16	5
20064	SFE 20 amp	1/4 x 1-1/4	5
20065	SFE 30 amp	1/4 x 1-7/16	5
21264	GBC 16 amp	1/4 x 1	5

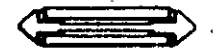
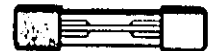
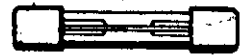

FUSE BLOCK ACCESSORY CLIP

(For Add-On Electrical Equipment)

J&B #	QTY
20050	50



FUSES

AUTOFUSE (Blade Type)

- Engineered for easy servicing - plugs in and out of the new miniaturized fuse block quickly and easily.
- **No more** bent clips and broken glass.
- Color coded for easy identification; amperage clearly marked on end of fuse.



J&B #	INDUSTRY #	COLOR	QTY
38921	ATC 1	BLACK	10
38922	ATC 2	GREY	10
38620	ATC 3	VIOLET	10
38923	ATC 4	PINK	10
38621	ATC 5	TAN	10
38622	ATC 7-1/2	BROWN	10
38623	ATC 10	RED	10
38624	ATC 15	LT. BLUE	10
38625	ATC 20	YELLOW	10
38626	ATC 25	WHITE	10
38627	ATC 30	LT. GREEN	10
38924	ATC 40	AMBER	10

BLADE TYPE FUSE TAP

- A quick, easy alternative to direct wiring when tapping the "hot side" of the fuse block.



J&B #	QTY
38619	25/BX

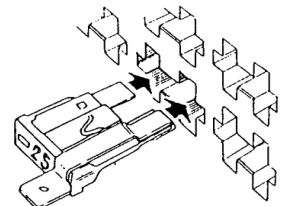
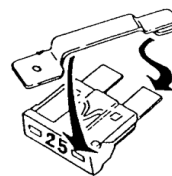

FUSE PULLER

- Tri-puller removes glass, ceramic, ATOF and Mini fuses.

J&B #	QTY
86090	EA



FUSES

ATO SMART GLOW FUSE

Automotive style Blade Type

- Smart Glow fuses are innovative automotive style fuses that feature an indicator light that glows when fuse is blown.
- Saves time to troubleshoot an open circuit.



J&B #	AMP RATING	COLOR	QTY
57390	5 AMP	TAN	5
57391	7-1/2 AMP	BROWN	5
57392	10 AMP	RED	5
57393	15 AMP	BLUE	5
57394	20 AMP	YELLOW	5
57395	25 AMP	NATURAL	5
57396	30 AMP	GREEN	5

MINI SMART GLOW FUSE

Automotive style Blade Type

- Smart Glow fuses are innovative automotive style fuses that feature an indicator light that glows when fuse is blown.
- Saves time to troubleshoot an open circuit.



J&B #	AMP RATING	COLOR	QTY
57400	5 AMP	TAN	5
57401	7-1/2 AMP	BROWN	5
57402	10 AMP	RED	5
57403	15 AMP	BLUE	5
57404	20 AMP	YELLOW	5
57405	25 AMP	NATURAL	5
57406	30 AMP	GREEN	5

LOW PROFILE MINI FUSES

(Blade Type)

- Provides the same quality features built into the ATO fuse but in a smaller more compact package.
- Low profile design is OEM on 2005-6 Toyota and GM products.



J&B #	AMP RATING	COLOR	QTY
20943	5 AMP	TAN	5
20944	7-1/2 AMP	BROWN	5
20945	10 AMP	RED	5
20946	15 AMP	BLUE	5
20947	20 AMP	YELLOW	5
20948	25 AMP	NATURAL	5
20949	30 AMP	GREEN	5

FUSES

MINI AUTOFUSE (Blade Type)

- Engineered for easy servicing - plugs in and out of the new miniaturized fuse block quickly and easily.
- **No more** bent clips and broken glass.
- Color coded for easy identification; amperage clearly marked on end of fuse.



(Mini)

J&B #	AMP RATING	COLOR	QTY
38601	2 AMP MINI	GREY	10
38603	3 AMP MINI	VIOLET	10
38604	4 AMP MINI	PINK	10
38605	5 AMP MINI	BROWN	10
38606	7-1/2 AMP MINI	DK. BROWN	10
38607	10 AMP MINI	RED	10
38608	15 AMP MINI	BLUE	10
38609	20 AMP MINI	YELLOW	10
38611	25 AMP MINI	TAN	10
38613	30 AMP MINI	GREEN	10

MINI BLADE TYPE FUSE TAP

- A quick, easy alternative to direct wiring when tapping
- The “hot side” of the fuse block.

J&B #	QTY
38659	25/BX

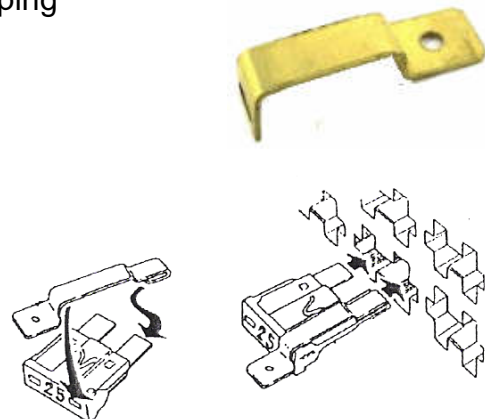

FUSES

MAXI AUTOMOTIVE FUSES

- Use where a high amperage circuit is required.
- Replaces fusible link wire in many automotive applications.

J&B #	AMP RATING	COLOR	QTY
42176	20 AMP	YELLOW	EA
42178	30 AMP	GREEN	EA
42180	40 AMP	ORANGE	EA
42182	50 AMP	RED	EA
42184	60 AMP	BLUE	EA
42174	70 AMP	TAN	EA
42175	80 AMP	PURPLE	EA



JCASE HIGH AMP FUSE

- Designed to replace the Maxi fuse and cartridge style fuses.
- Currently OEM on many new domestic and Japanese models.
- Patented technology provides both increased time delay and low voltage drop.
- Voltage rating characteristics = 32V AC/DC Slo-Blo.

J&B #	AMP RATING	COLOR	QTY
42705	20 AMP	BLUE	EA
42710	25 AMP	WHITE	EA
42706	30 AMP	PINK	EA
42707	40 AMP	GREEN	EA
42708	50 AMP	RED	EA
42709	60 AMP	YELLOW	EA



AUTO LINK PAL FUSES

Female Terminal

- Commonly found on many Japanese and Domestic built vehicles in current ratings up to 120 amperes.

J&B #	AMP RATING	COLOR	QTY
57420	20 AMP	BLUE	EA
57421	30 AMP	PINK	EA
57422	40 AMP	GREEN	EA
57423	50 AMP	RED	EA
57424	60 AMP	YELLOW	EA



AUTO LINK PAL FUSES

Mini Female Terminal

J&B #	AMP RATING	COLOR	QTY
57430	30 AMP	PINK	EA
57431	40 AMP	GREEN	EA



FUSES

LOW PROFILE JCASE FUSE

- Smaller space saving footprint is being designed in by many OEM's.
- Patented technology provides both increased time delay & low voltage drop.

J&B #	AMP RATING	COLOR	QTY
86110	20 AMP	BLUE	EA
86111	25 AMP	CLEAR	EA
86112	30 AMP	PINK	EA
86113	40 AMP	GREEN	EA
86114	50 AMP	RED	EA
86115	60 AMP	YELLOW	EA



MCASE FUSE

- Cartridge style fuse with female terminals for 2.8 mm male terminals.
- Miniaturized footprint for optimal usage of space. Time delayed fuse.

J&B #	AMP RATING	COLOR	QTY
86091	15 AMP	TAN	EA
86092	20 AMP	BLUE	EA
86093	25 AMP	CLEAR	EA
86094	30 AMP	PINK	EA
86095	40 AMP	GREEN	EA



MICRO2 BLADE FUSE

- Its sub-miniature design meets the need for more circuits to be protected while utilizing less space & its ability to cope with high temperatures in adverse environments makes the MICRO2 fuse the recommended choice for protection.

J&B #	AMP RATING	COLOR	QTY
86097	5 AMP	TAN	10
86098	7.5 AMP	BROWN	10
86099	10 AMP	RED	10
86100	15 AMP	BLUE	10
86101	20 AMP	YELLOW	10
86102	25 AMP	CLEAR	10
86103	30 AMP	GREEN	10



MICRO3 BLADE FUSE

J&B #	AMP RATING	COLOR	QTY
86105	5 AMP	TAN	5
86106	7.5 AMP	BROWN	5
86107	10 AMP	RED	5
86108	15 AMP	BLUE	5



FUSE HOLDERS

NYLON IN-LINE H.D. FUSE HOLDER

- Black 12 ga. wire leads.
- Contains 30 amp fuse.

J&B #	QTY
20037	5/BX



ENVIRONMENTALLY SEALED AUTOFUSE HOLDER

- Resistant to moisture, salt spray and engine compartment fluids.
- Withstands 50 g physical shock; Operating temperature range from -40° to 125°C.

INCLUDES: . . .

- Nylon body with latching cap
- Silicone rubber seals at wires and cap
- 12 gauge wire leads
- 3 to 30 Amp capacity - type ATC/ATO fuses

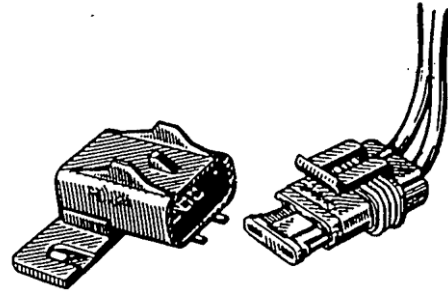

J&B #	QTY
40087	2/BX

ATC & ATO WATERPROOF INLINE FUSE HOLDER

- Inline waterproof fuse holder is compatible with ATC & ATO blade fuses.
- Deluxe waterproof body & water resistant cap is ideal for marine applications or any application that is continually in wet environments.

J&B #	WIRE SIZE	MAX AMP	WIRE COLOR	QTY
45220	16 Ga.	10	RED	2/BX
45221	12 Ga.	30	RED	2/BX
45222	10 Ga.	35	RED	2/BX



IN-LINE FUSE HOLDER FOR AUTOFUSES

- Comes with two 4" pigtails.

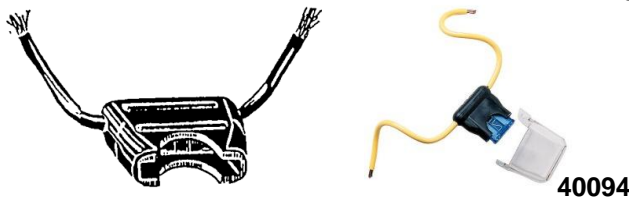

J&B #	AMP	VOLT	WIRE GA.	QTY
40086	20	32	16	5/BX
41900	30	32	12	5/BX
40094	COVER FOR 41900			5/BX

SELF-STRIPPING FUSE HOLDER

- Mates with most plug-in, blade type fuses.
- For 18-14 gauge copper wire.

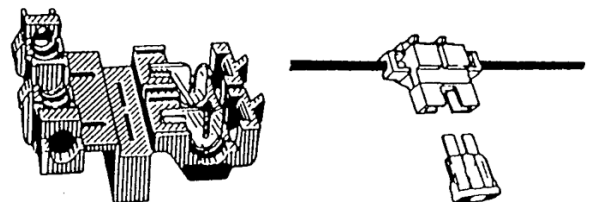

J&B #	QTY
40088	5/BX

FUSE HOLDERS

ENVIRONMENTALLY SEALED MINI FUSE HOLDER

- Holder for mini automotive fuse, 12 gauge wire, 4" long leads for 30 amps, 32 volts
- Protective cover included.

J&B #	QTY
40083	5/BX



ENVIRONMENTALLY SEALED MAXI FUSE HOLDER

- Holder for maxi automotive fuse, 6 gauge wire, 5" long leads for up to 60 amps, 32 volts
- Protective cover included.

J&B #	QTY
40089	2/BX



SMART GLOW ATC FUSE HOLDER

- For use with ATC fuses that light when they blow. 12 gauge, 4" leads, 40 amp, 12 volt.
- Protective cover included.

J&B #	QTY
40085	2/BX



SMART GLOW MINI FUSE HOLDER

- For use with mini autofuses that light when they blow. 14 gauge, 6" leads, 30 amp, 12 volt.
- Protective cover included.

J&B #	QTY
40084	2/BX



FUSE HOLDERS

JCASE FUSE HOLDER

- This inline JCase fuse holder is a cartridge fuse holder that is designed to be used with standard and low profile JCase fuses.
- The fuse holder features a weatherproof housing and fusible connection for any automotive and marine system.
- Holders offer a compact and weight savings design compared to regular Maxi fuse holder.
- 4 inch wire leads with GXL insulation with protective cover for splash resistance.
- Rated up to 60 amps at 58V DC for operating temperatures of -40 degree F to 125 degree F.



J&B #	QTY
45223	2/BX

CIRCUIT BREAKERS

SNAP IN TYPE

- For 12 volt electrical circuit.

J&B #	AMPS	QTY
38980	10	1
38981	15	1
38982	20	1
38983	30	1
38984	40	1

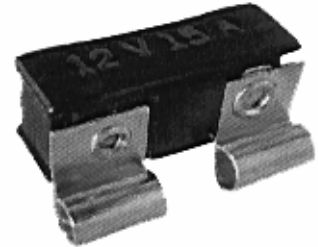

BLADE "PLUG-IN" TYPE (W/ Break-Off Tabs)

- Snap-off tabs allow **broad coverage** for most popular trucks and helps to minimize inventory.
- Heavy-duty replacement for ATC and ATO blade-type fuses.
- These breakers remain open until the trouble on the line is corrected, or the power is turned off.
- For 12 volt D.C. systems.

J&B #	AMPS	QTY
40960	10	2
40961	15	2
40962	20	2
40963	25	2
40964	30	2

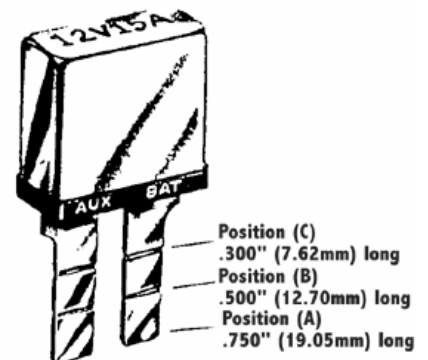

VEHICLE REPLACEMENT GUIDE	
Terminal Position (A)	Ford Pick-up Trucks
Terminal Position (B)	Chrysler & Dodge Trucks Ford Trucks (Heavy) IH Trucks
Terminal Position (C)	Kenworth Trucks

SWITCHES

TOGGLE SWITCHES For Universal Applications

- Manufactured and tested to rigid standards to assure trouble-free performance and long life; mounting hardware supplied.



J&B #	QTY
39286	EA

INCLUDES . . .

- Two positions: On-Off
- 2 screw terminals
- 12 volt, D.C. lamp load
- 25 Amps
- Silver contacts
- Mounted stem 15/32" long
- Durable molded bakelite housings



J&B #	QTY
42380	EA

TOGGLE SWITCH BOOT

- Made from tough silicon rubber
- Protect switches from moisture dust and dirt
- Built in hex nut base
- UL listed



J&B #	QTY
39288	EA

INCLUDES . . .

- Three positions: On-Off-On
- 3 screw terminals
- 12 volt, D.C. inductive load
- 35 Amps
- Silver contacts
- Mounted stem 15/32" long
- Durable molded bakelite housings

UNIVERSAL PUSH-PULL SWITCH

- Heavy gauge steel housings plated to resist corrosion.
- Extra heavy duty type for up to 36 volt applications.
- Mounting hardware supplied.

INCLUDES . . .

- Plastic screw-on knob
- 2 screw terminals with lockwashers
- Mounting stem 3/8" dia., 5/8" long
- Silver contacts



J&B #	QTY
39287	EA

MOMENTARY PUSH BUTTON SWITCH

- For starter, signaling applications and momentary control of D.C. electrical circuits and equipment.
- Extra heavy duty for up to 36 volt applications.

INCLUDES . . .

- Silver contacts
- Grey rubber cap and mounting nut assembly
- Hex nut to adjust for panel thickness
- Two screw terminals with lockwashers
- Mounting stem 5/8-32 thread, 21/32" long
- Fits panels up to 7/32" thick



J&B #	QTY
39285	EA

FLASHERS

12 lamp electronic flasher

FMVSS 108 SAE J945, J590, and 1690 class A

Heavy duty design

60-120 Flashes per minute

Fits all standard round sockets

11-15 volt, 25 amp, 1 to 12 lamp capacity

J&B #	PRONG	IND. #	QTY
20058	2	EF32	EA
20061	3	EF33	EA



Self Adjusting LED flasher

FMVSS 108 SAE J945, J590, and 1690 class A

Heavy duty design, **External wire provides ground** **THESE MAY BE ROUND OR SQUARE**

Automatically adjusts to LED current draw

Steady flash rate for all LED applications

11-15 volt, 0.10 to 25 amp max capacity

ROUND PART #'S ARE EF32RL & EF33RL

J&B #	PRONG	IND. #	QTY
20059	2	EF32L	EA
20062	3	EF33L	EA



12 lamp electronic flasher

FMVSS 108 SAE J945, J590, and 1690 class A

H/D design rated for 100 hrs. of continuous operation.

60-120 Flashes per minute

Fits all standard round sockets

11-15 volt, 25 amp, 1 to 12 lamp capacity

J&B #	PRONG	IND. #	QTY
20060	2	EF32H	EA
20066	3	EF33H	EA



FLASHERS

H/D FLASHER



J&B #	INDUSTRY #	VOLTS	# OF PRONGS	# OF LAMPS	LAMP C.P.	TYPE OF BULB	QTY
20047	552/536	12	2	2 to 8	32	STANDARD/ LONG LIFE	EA

H/D MOTORIZED FLASHERS

Wagner

- Replaces all 2 & 3 prong 12 volt truck flashers.
- 80-100 flashing cycles per minute.
- Lasts at least 5 times longer than other flashers.
- Gives greater protection when trucks are parked or disabled.

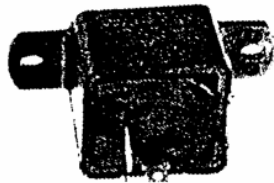

J&B #20046

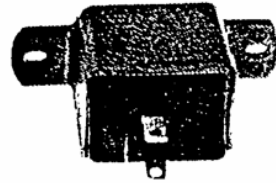

J&B #20074

J&B #	INDUSTRY #	VOLT	PRONGS	COLOR	QTY
20046	852/5X	12	2	BLACK	EA
20074	850/5X	12	3	YELLOW	EA

PIGTAIL CONNECTORS

PIGTAIL CONNECTOR

Single Large Wire Lead - 12" Long

- For sockets housing single contact lights.

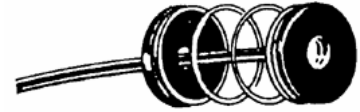

J&B #	QTY
40080	10/BX

PIGTAIL CONNECTOR

Double Wire Lead - 12" Long Aligned Ears

- For sockets housing double contact lights.

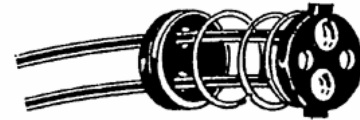

J&B #	QTY
40082	10/BX

ALTERNATOR PIGTAIL

- For use on cars with transistorized alternators.

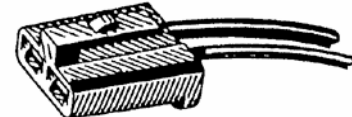

J&B #	QTY
22256	5/BX

FRONT AND REAR MARKER LIGHT ASSEMBLY

- Featuring a protective molded vinyl housing and twin 12" leads pre-stripped 1/4".

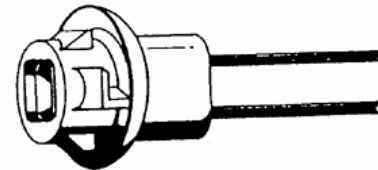

J&B #	QTY
21151	5/BX

MUFFLER CLAMPS

HEAVY DUTY CLAMPS

- 3/8" U-bolt.
- H.D. 11 ga. saddle.

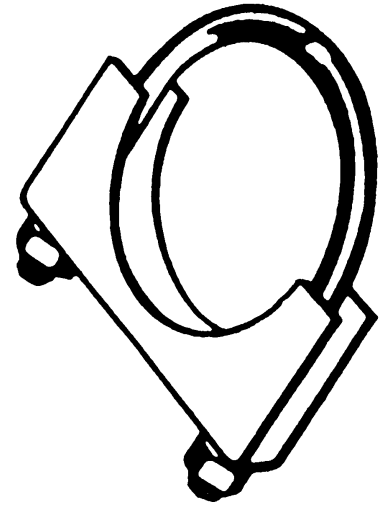

J&B #	SIZE	QTY
21082	1-1/2	EA
21084	1-3/4	EA
21085	1-7/8	EA
21220	2	EA
21221	2-1/4	EA
21222	2-1/2	EA
38990	2-3/4	EA
38991	3	EA
38992	3-1/2	EA
38993	4	EA
38994	5	EA

TAILPIPE HANGERS

HEAVY DUTY 360° TAIL PIPE HANGER

- 360° swivel allows easy mounting in **any position**.
- Unique open lip installs without disassembling clamp.
- Elongated holes for easy positioning.
- Use for automotive, R.V., truck and bus applications.

J&B #	QTY
20235	EA

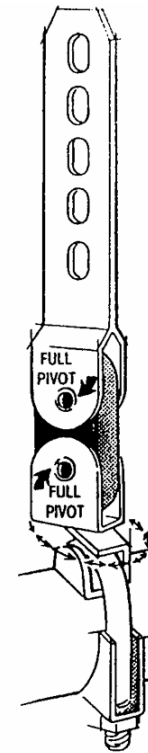

UNIVERSAL TAILPIPE HANGER

- Elongated holes for easy positioning.

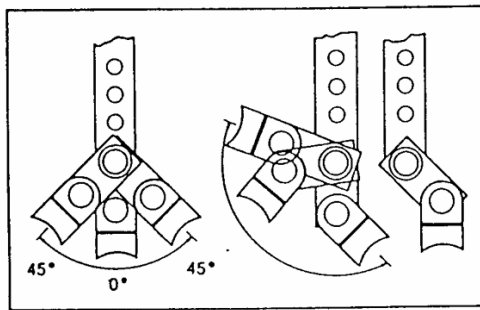

* SWINGS LEFT AND RIGHT FROM ZERO TO 45° WITH RIGHT AND LEFT DEEP KNEE BENDS.

J&B #	QTY
21092	EA

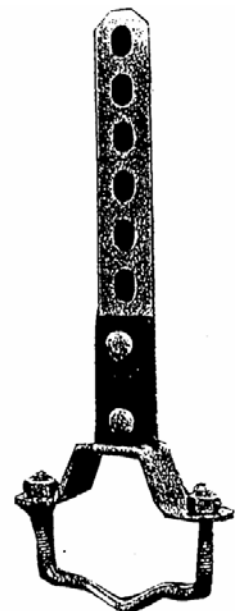

WHEEL WEIGHTS

“REG” REGULAR STYLE WHEEL WEIGHTS

Steel Wheels (Passenger)

FOR USE ON ALL PASSENGER RIMS EXCEPT WHERE THERE IS LIMITED CLEARANCE FOR WHEEL WEIGHT DUE TO RESTRICTION BY FULL FLUSH WHEEL DISC. HEAVY CROSS SECTION ASSURES MAXIMUM STRENGTH AND RIGIDITY.

J&B #	WEIGHT	QTY
40800	1/4	50
40801	1/2	50
40802	3/4	50
40803	1	50
40804	1-1/4	50
40805	1-1/2	50
40806	1-3/4	50
40807	2	50
40808	2-1/4	50
40809	2-1/2	50
40810	2-3/4	50
40811	3	50



SOLD IN BOX QUANTITIES ONLY

“AWC” O.E.M. ALLOY WHEEL WEIGHTS

Coated

J&B #	WEIGHT	QTY
40840	1/4	25
40841	1/2	25
40842	3/4	25
40843	1	25
40844	1-1/4	25
40845	1-1/2	25
40846	1-3/4	25
40847	2	25
40848	2-1/4	25
40849	2-1/2	25
40850	2-3/4	25
40851	3	25



SOLD IN BOX QUANTITIES ONLY

ADHESIVE WHEEL WEIGHT STRIPS

Steel

- Holding fast with 3M acrylic tape.



J&B #	WEIGHT	SIZE OF STRIP	SIZE OF WEIGHT	SEGMENTS PER STRIP	QTY PER BOX
45665	1/4 oz.	3/4 x 7-5/8"	3/4 x 5/8	12	52 STRIPS (624 PIECES)
41229	1/2 oz.	3/4 x 7-5/8"	3/4 x 5/8	8	28 STRIPS (224 PIECES)
41237	1.00 oz.	3/4 x 6"	3/4 x 1"	6	15 STRIPS (90 PIECES)
*41239	2.00 oz.	1-1/4 x 7-1/16"	1-1/4 x 1"	6	8 STRIPS (48 PIECES)

* 41239 2.00 oz. are lead wheel weights.

--- NO BROKEN BOXES

WHEEL WEIGHTS

“MCC” OEM ALLOY WHEEL WEIGHTS Coated

J&B #	WEIGHT	QTY
41089	1/4	25
41090	1/2	25
41091	3/4	25
41092	1	25
41093	1-1/4	25
41094	1-1/2	25
41095	1-3/4	25
41096	2	25
41097	2-1/4	25
41107	2-1/2	25
41108	2-3/4	25
41109	3	25



SOLD IN BOX QUANTITIES ONLY

“LHC” OEM ALLOY WHEEL WEIGHTS Coated

J&B #	WEIGHT	QTY
45650	1/4	25
45651	1/2	25
45652	3/4	25
45653	1	25
45654	1-1/4	25
45655	1-1/2	25
45656	1-3/4	25
45657	2	25
45658	2-1/4	25
45659	2-1/2	25
45661	2-3/4	25
45662	3	25



SOLD IN BOX QUANTITIES ONLY

WHEEL WEIGHTS

“TSC” OEM ALLOY WHEEL WEIGHTS Coated

J&B #	WEIGHT	QTY
40787	1/4	25
40788	1/2	25
40789	3/4	25
40790	1	25
40791	1-1/4	25
40792	1-1/2	25
40793	1-3/4	25
40794	2	25
40795	2-1/4	25
40796	2-1/2	25
40797	2-3/4	25
40798	3	25



SOLD IN BOX QUANTITIES ONLY

“ENC” OEM ALLOY WHEEL WEIGHTS Coated

J&B #	GRAMS	OUNCES	QTY
40776	10	1/4	25
40777	15	1/2	25
40778	20	3/4	25
40780	30	1	25
40781	35	1-1/4	25
40783	45	1-1/2	25
40784	50	1-3/4	25
40785	55	2	25



SOLD IN BOX QUANTITIES ONLY

WHEEL WEIGHTS

“FNC” OEM ALLOY WHEEL WEIGHTS Coated

J&B #	GRAMS	OUNCES	QTY
40692	5	11/64	25
40693	10	1/4	25
40694	15	1/2	25
40695	20	3/4	25
40696	25	7/8	25
40697	30	1	25
40698	35	1-1/4	25
40699	40	1-3/8	25
40701	45	1-1/2	25
40702	50	1-3/4	25
40703	55	2	25
40704	60	2-1/4	25



SOLD IN BOX QUANTITIES ONLY

“IAWC” OEM ALLOY WHEEL WEIGHTS Coated

J&B #	GRAMS	OUNCES	QTY
40705	5	11/64	25
40706	10	1/4	25
40707	15	1/2	25
40708	20	3/4	25
40709	25	7/8	25
40711	30	1	25
40712	35	1-1/4	25
40713	40	1-3/8	25
40714	45	1-1/2	25
40715	50	1-3/4	25
40716	55	2	25
40717	60	2-1/4	25



SOLD IN BOX QUANTITIES ONLY

PASSENGER CARS - AUTOMOBILES

	2002	2003	2004	2005	2006	2007	2008	2009	2010	2011	2012
All Acura [†]	FN	FN	FN	FN	FN	FN	FN	FN	FN	FN	FN
All Audi [†]	EN	EN	EN	EN	EN	EN	EN	EN	EN	EN	EN
All BMW [†]	IAW	IAW	IAW	IAW	IAW	IAW	IAW	IAW	IAW	IAW	IAW
All Buick	MC	MC	MC	MC	MC	MC	MC	MC	MC	MC	MC
All Cadillac	MC	MC	MC	MC	MC	MC	MC	MC	MC	MC	MC
Chevrolet											
Aveo			IAW	IAW	IAW	IAW	IAW	IAW	IAW	IAW	IAW
Corvette [†]	AW ADHESIVE	AW ADHESIVE	AW ADHESIVE	AW ADHESIVE	AW ADHESIVE	AW ADHESIVE	AW ADHESIVE	AW ADHESIVE	AW ADHESIVE	AW ADHESIVE	AW ADHESIVE
Epica				IAW	IAW	IAW					
Optra			IAW	IAW	IAW	IAW	IAW				
All Others	MC	MC	MC	MC	MC	MC	MC	MC	MC	MC	MC
Crysler											
300M, Concorde & LHS	LH	LH	LH	MC	MC	MC	MC	MC	MC	MC	MC
Crossfire			ADHESIVE	ADHESIVE	ADHESIVE	ADHESIVE	ADHESIVE	ADHESIVE			
Prowler	ADHESIVE										
PT Cruiser	LH	LH	LH	LH	LH	LH	LH	LH	LH		
Sebring (sedan, convertible)	LH	LH	LH	LH	LH	MC	MC	MC	MC	MC	MC
All others [‡]	LH	LH	LH	LH MC	LH MC	LH MC	LH MC	LH MC	LH MC	LH MC	LH MC
All Daewoo	FN										
Dodge											
Intrepid	LH	LH	LH	LH	LH						
Neon	LH	LH	LH	LH							
Stratus (sedan)	LH	LH	LH	LH	LH						
Viper [†]	MC ADHESIVE	MC ADHESIVE	MC ADHESIVE	MC ADHESIVE	MC ADHESIVE	MC ADHESIVE					
All others	LH	LH	LH	MC	MC	MC	MC	MC	MC	MC	MC
All Ford [†]	MC	MC	MC	MC	MC	MC	MC	MC	MC	MC	MC
All Honda [†]	FN	FN	FN	FN	FN	FN	FN	FN	FN	FN	FN
Hyundai											
Tiburon, Genesis	ADHESIVE	ADHESIVE	ADHESIVE	ADHESIVE	ADHESIVE	ADHESIVE	ADHESIVE	ADHESIVE	ADHESIVE	ADHESIVE	ADHESIVE
All others	IAW	IAW	IAW	IAW	IAW	IAW	IAW	IAW	IAW	IAW	IAW
All Infiniti [†]	FN	FN	FN	FN	FN	FN	FN	FN	FN	FN	FN
All Isuzu	FN	FN	FN	FN	FN	FN					
All Jaguar [†]	IAW	IAW	IAW	IAW	IAW	IAW	IAW	IAW	IAW	IAW	IAW
All Kia	IAW	IAW	IAW	IAW	IAW	IAW	IAW	IAW	IAW	IAW	IAW



Use rim gauge RGP-1 to verify correct application clip on style weights.

P

AW

MC

IAW

FN

T

EN

LH

PASSENGER CARS - AUTOMOBILES

	2002	2003	2004	2005	2006	2007	2008	2009	2010	2011	2012
All Lexus [†]	FN	FN	FN	FN	FN	FN	FN	FN	FN	FN	FN
All Lincoln [†]	MC	MC	MC	MC	MC	MC	MC	MC	MC	MC	MC
Mazda											
Mazda 6 [†] , 626	MC	MC	MC	MC	MC	MC	MC	MC	MC	MC	MC
All Others [†]	FN	FN	FN	FN	FN	FN	FN	FN	FN	FN	FN
All Mercedes Benz [†]	EN	EN	EN	EN	EN	EN	EN	EN	EN	EN	EN
All Mercury [†]	MC	MC	MC	MC	MC	MC	MC	MC	MC	MC	MC
All Mini [†]	IAW	IAW	IAW	IAW	IAW	IAW	IAW	IAW	IAW	IAW	IAW
Mitsubishi											
Eclipse, Eclipse Spyder	IAW	IAW	IAW	MC	MC	MC	MC	MC	MC	MC	MC
Galant	IAW	IAW	IAW	MC	MC	MC	MC	MC	MC	MC	MC
All Others	IAW	IAW	IAW	IAW	IAW	IAW	IAW	IAW	IAW	IAW	IAW
All Nissan [†]	FN	FN	FN	FN	FN	FN	FN	FN	FN	FN	FN
All Oldsmobile	MC	MC	MC	MC							
Pontiac											
G3, Wave			IAW	IAW	IAW	IAW	IAW	IAW			
GTO [†]			ADHESIVE	ADHESIVE	ADHESIVE	ADHESIVE					
Vibe [†]		FN	FN	FN	FN	FN	FN	FN			
All Others	MC	MC	MC	MC	MC	MC	MC	MC	MC	MC	MC
All Porsche	ADHESIVE	ADHESIVE	ADHESIVE	ADHESIVE	ADHESIVE	ADHESIVE	ADHESIVE	ADHESIVE	ADHESIVE	ADHESIVE	ADHESIVE
All Saab	IAW	IAW	IAW	IAW	IAW	IAW	IAW	IAW	IAW	IAW	IAW
All Saturn [†]	MC	MC	MC	MC	MC	MC	MC	MC			
All Scion [†]				FN	FN	FN	FN	FN	FN	FN	FN
All Smart [†]					IAW	IAW	IAW	IAW	IAW	IAW	IAW
All Subaru [†]	IAW	IAW	IAW	IAW	IAW	IAW	IAW	IAW	IAW	IAW	IAW
All Suzuki [†]	IAW	IAW	IAW	IAW	IAW	IAW	IAW	IAW	IAW	IAW	IAW
All Toyota [†]	FN	FN	FN	FN	FN	FN	FN	FN	FN	FN	FN
All Volkswagen [†]	EN	EN	EN	EN	EN	EN	EN	EN	EN	EN	EN
All Volvo [†]	IAW	IAW	IAW	IAW	IAW	IAW	IAW	IAW	IAW	IAW	IAW

Use rim gauge RGP-1 to verify correct application clip on style weights.



P

AW

MC

IAW

FN

T

EN

LH

LIGHT TRUCKS, SUVS & MINIVANS

	2002	2003	2004	2005	2006	2007	2008	2009	2010	2011	2012
All Acura	FN	FN	FN	FN	FN	FN	FN	FN	FN	FN	FN
All Audi [†]					EN	EN	EN	EN	EN	EN	EN
All Buick	MC	MC	MC	MC	MC	MC	MC	MC	MC	MC	MC
All BMW [†]	IAW	IAW	IAW	IAW	IAW	IAW	IAW	IAW	IAW	IAW	IAW
All Cadillac	MC T	MC T	MC T	MC T	MC T	MC T	MC T	MC T	MC T	MC T	MC T
All Chevrolet	MC T	MC T	MC T	MC T	MC T	MC T	MC T	MC T	MC T	MC T	MC T
All Crysler	LH	LH	LH	LH	LH	LH	LH	LH	MC	MC	MC
Dodge											
Grand Caravan	LH	LH	LH	LH	LH	LH	LH	LH	MC	MC	MC
All others [‡]	MC T	MC T	MC T	MC T	MC T	MC T	MC T	MC T	MC T	MC T	MC T
Ford											
Explorer	MC EN	MC EN	MC EN	MC EN	MC EN	MC	MC	MC	MC	MC	MC
Ranger	MC EN	MC EN	MC EN	MC EN	MC EN	MC	MC	MC	MC	MC	MC
All others [‡]	MC T	MC T	MC T	MC T	MC T	MC T	MC T	MC T	MC T	MC T	MC T
GMC											
Sierra, Silverado, Suburban	T	T	T	T	T	MC T	MC T	MC T	MC T	MC T	MC T
Savana	MC	MC	MC	MC	MC T	MC T	MC T	MC T	MC T	MC T	MC T
Yukon, Denali	MC	MC	MC T	MC T	MC T	MC T	MC T	MC T	MC T	MC T	MC T
All others	MC	MC	MC	MC	MC	MC	MC	MC	MC	MC	MC
Honda											
Passeport	IAW										
All others	FN	FN	FN	FN	FN	FN	FN	FN	FN	FN	FN
All Hummer		MC	MC	MC	MC	MC	MC	MC	MC	MC	MC
All Hyundai	IAW	IAW	IAW	IAW	IAW	IAW	IAW	IAW	IAW	IAW	IAW
All Infiniti [†]	FN	FN	FN	FN	FN	FN	FN	FN	FN	FN	FN
All Isuzu		MC	MC	MC	MC	MC	MC	MC			
All Jeep	MC	MC	MC	MC	MC	MC	MC	MC	MC	MC	MC
All Kia	IAW	IAW	IAW	IAW	IAW	IAW	IAW	IAW	IAW	IAW	IAW
All Land Rover [†]	IAW	IAW	IAW	IAW	IAW	IAW	IAW	IAW	IAW	IAW	IAW



Use rim gauge RGP-1 to verify correct application clip on style weights.

LIGHT TRUCKS, SUVS & MINIVANS

	2002	2003	2004	2005	2006	2007	2008	2009	2010	2011	2012
All Lexus[†]	FN	FN	FN	FN	FN	FN	FN	FN	FN	FN	FN
Lincoln											
Aviator		ADHESIVE	ADHESIVE	ADHESIVE							
All Others	T	MC	MC	MC	MC	MC	MC	MC	MC	MC	MC
Mazda											
B Series	MC	MC	MC	MC	MC	MC	MC	MC	MC	MC	MC
Tribute	MC	MC	MC	MC	MC	MC	MC	MC	MC	MC	MC
All Others [†]	FN	FN	FN	FN	FN	FN	FN	FN	FN	FN	FN
All Mercedes Benz[†]	EN	EN	EN	EN	EN	EN	EN	EN	EN	EN	EN
Mercury											
Mountaineer [†]	MC EN	MC EN	MC EN	MC EN	MC EN	MC	MC	MC	MC	MC	MC
Villager	FN										
All Others			MC	MC	MC	MC	MC	MC	MC	MC	MC
Mitsubishi											
Endeavor			IAW	IAW	MC	MC	MC	MC	MC	MC	MC
All Others	IAW	IAW	IAW	IAW	IAW	IAW	IAW	IAW	IAW	IAW	IAW
All Nissan[†]	FN	FN	FN	FN	FN	FN	FN	FN	FN	FN	FN
All Oldsmobile	MC	MC	MC								
All Pontiac	MC	MC	MC	MC	MC	MC	MC	MC	MC		
All Saab				MC	MC	MC	MC	MC	MC		
All Saturn	MC	MC	MC	MC	MC	MC	MC	MC	MC		
All Scion[†]					FN	FN	FN	FN	FN	FN	FN
All Subaru[†]	IAW	IAW	IAW	IAW	IAW	IAW	IAW	IAW	IAW	IAW	IAW
Suzuki											
XL-7					MC	MC	MC	MC			
All Others	IAW	IAW	IAW	IAW	IAW	IAW	IAW	IAW	IAW	IAW	IAW
All Toyota[†]	FN	FN	FN	FN	FN	FN	FN	FN	FN	FN	FN
Volkswagen[†]											
Routan	EN	EN	EN	EN	EN	EN	EN	EN	MC	MC	MC
All Others	EN	EN	EN	EN	EN	EN	EN	EN	EN	EN	EN
All Volvo	IAW	IAW	IAW	IAW	IAW	IAW	IAW	IAW	IAW	IAW	IAW

Gram	Ounce	Gram	Ounce
10	0.25	35	1.25
15	0.50	40	1.375
20	0.75	45	1.5
25	0.875	50	1.75
30	1.00	55	2.00
35	1.25	60	2.25

Weight type	Unit	Color code
AW	OUNCE	RED
MC	OUNCE	YELLOW
FN	GRAM	ORANGE
IAW	GRAM	BLUE
EN	GRAM	GREEN
T	OUNCE	GRAY
LH	OUNCE	PURPLE

Color appears on label, application guide, rim gauge and storage bins.



Use rim gauge RGP-1 to verify correct application clip on style weights.

WHEEL CHOCKS

- Made of molded nylon reinforced rubber.
- Recommended for **heavy** trucks, trailers, and road building equipment.
- Ideal for use on blacktop surface.
- Comes with eyebolt for attaching chain.

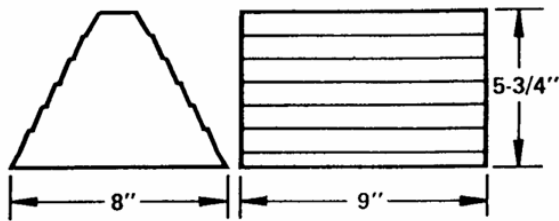
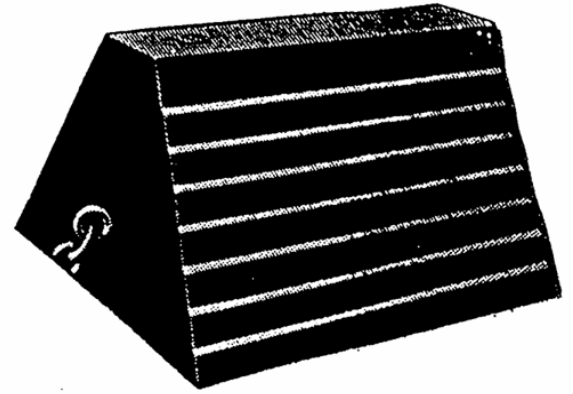

J&B #	WEIGHT	COLOR	QTY
39390	9 LBS.	BLACK	EA

TIRE PRODUCTS

VALVE CAPS



J&B #	DESCRIPTION	QTY
20458	Black Plastic Cap	25
39023	Black Plastic Cap with Seal	100
39009	Long Skirted Black Plastic Cap with Seal	100
39014	Gray Plastic Cap with Seal	100
39016	Green Plastic Cap with Seal	1000
39017	Long Metal Dome Cap with Seal	50
39019	Double Seal Valve Cap	25

VALVE CORES

J&B #	TYPE	QTY
20454	Standard	100
39037	Nickel Plated	100



VALVE CORE REMOVER

J&B #	QTY
39027	EA



TIRE PRODUCTS

TUBELESS SNAP-IN TIRE VALVES

- Rubber snap-in type.
- 65 psi maximum cold inflation pressure.
- Supplied complete with cap and core.

J&B #	RIM HOLE SIZE	LENGTH	QTY
20460	.453	1-1/4"	50
20462	.453	1-1/2"	50
20461	.453	2"	50



HIGH PRESSURE SNAP-IN TIRE VALVES

- Brass/Rubber.
- 80 psi maximum cold inflation pressure.

J&B #	RIM HOLE SIZE	LENGTH	QTY
41558	.453	1.27"	25



TPMS SNAP-IN VALVE

- Rubber.

J&B #	QTY
39026	10



4-WAY VALVE TOOL

- Repairs, reconditions inside and outside valve threads; inserts and removes cores.
- Cadmium plated.

J&B #	QTY
38762	EA

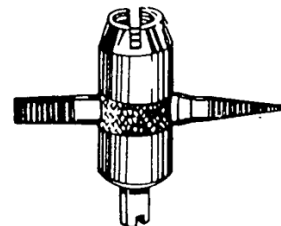

TIRE PRODUCTS

TRUCK TIRE GAUGE

- Straight on truck service gauge. Dual chuck.
- 10-150 PSI.
- Xtra Seal Brand



J&B #	QTY
V9703	EA

STRAIGHT FOOT DUAL HEAD AIR CHUCK

- Milton brand.
- Maximum air pressure of 150 lbs per square inch.



J&B #	SIZE	QTY
39146	1/4" Female N.P.T.	EA

ANGLED DUAL-FOOT AIR CHUCK

- Master brand.



J&B #	SIZE	QTY
38940	1/4" Female N.P.T.	EA

BALL FOOT CHUCK

J&B #	SIZE	QTY
38764	1/4" Female N.P.T.	EA



LOCK-ON AIR CHUCK

Closed

- Maximum operating pressure = 150 psi.



J&B #	SIZE	QTY
39000	1/4" Female N.P.T.	EA

TIRE PRODUCTS

COMBINATION UNITS Square Lead-Wire

- For use in radial & bias ply tires.
- Designed for chemical or heat vulcanization.
- Patch portion has gray vulcanizing gum with blue poly backing.
- Stem portion is wrapped with gray vulcanizing gum.
- No special insert tools required. Install from the inside, pull through, and cut off wire.



J&B #	XTRA SEAL #	STYLE	PATCH SIZE	STEM DIAMETER	QTY
41294	13-673	Dipped	2-1/8"	1/4	24
41295	13-672C	Wrapped	1-5/8"	7/32	24
41296	13-673C	Wrapped	2-1/8"	5/16	24

**** CAN'T BREAK BOXES ****

COTTON TIRE SWAB

- 15" cotton tire swab applicator.

J&B #	QTY
39022	EA



TIRE PRODUCTS

TUBELESS TIRE REPAIR Safety Seal

- 4" Fat.
- Brown.
- Tire patch instructions are on box.

J&B #	QTY
38760	60



APPLICATOR

- Euro-Paste Application Brush.

J&B #	QTY
38761	EA



TIRE-PASTE

- Environmentally friendly. Non-toxic.
- Helps beads to seal properly.
- Protects tire beads from
- Makes tire mounting/demounting easier.

J&B #	COLOR	QTY
38763	Blue	EA

4 in a case



6-1/2 lbs.

X-TRA SLIK

Tire Bead Lubricant with Rust Inhibitors

- Environmentally friendly. Non-toxic.
- Helps beads to seal properly.
- Protects tire beads from damage.
- Makes tire mounting/demounting easier.

J&B #	QTY
38765	EA

4 in a case



1 Gallon

WHITE PAINT STICKS

- 1/2" Hex-shaped.

J&B #	QTY
20596	12

* Sold in box of 12 only



TIRE PRODUCTS

CHEMICAL VULCANIZING CEMENT

- A flammable vulcanizing fast drying cement.

J&B #	QTY
38766	EA

12 in a case

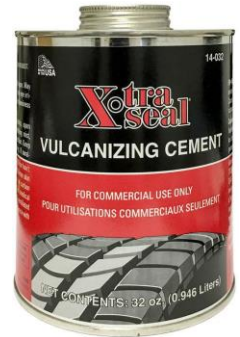

32 Oz.

RUBBER PREP

- For removing dirt, debris and mold lubricants from the repair area prior to buffing.
- A flammable pre-buff rubber cleaner.

J&B #	QTY
38769	EA

12 in a case



32 Oz.

BEAD SEALER

- For sealing small air leaks between the tire bead and the wheel.
- Flammable.

J&B #	QTY
38771	EA

12 in a case



32 Oz.

CHEMICAL VULCANIZING CEMENT

FEATURES AND BENEFITS:

- For chemical or heat vulcanization.
- Flammable.

J&B #	QTY
38849	EA

12 in a case



8 Oz.

TIRE PRODUCTS

LEAK SEALER

- Finds slow leaks in tubeless tires.

J&B #	QTY
49110	EA



8 Oz.

NO RIM RUST

Tire Lubricant & Rim Rust Retardant

- Ideal for use on steel and aluminum wheels and rims, both Tube and tubeless types.
- It lubricates rim for easy tire mounting and demounting. Prevents tires from fusing to rim.
- It's economical cost of only cents per application saves tires and prevents damage to tire changing equipment.
- It helps prevent corrosion of rims and rings and is ideal wherever a lubricant and rust inhibitor is desired.

J&B #	QTY
49111	EA



5 LBS.

INNER LINER SEALER

- For use with all passenger, commercial, truck, farm service and O.T.R. tires.
- Flammable.

J&B #	QTY
49112	EA



16 Oz.

MOULDING TAPE

MTP-1 MOULDING TAPE PRIMER

- Designed to work inconjunction with IES Conform Tape.
- Specifically designed to leave an acrylic polymer film (adhesion promoter) on the surface to achieve maximum adhesion of attachment tape to the moulding.
- Mouldings made out of PVC and other certain plastics (see moulding tape application chart inside of tape package) require use of MTP-1 moulding tape primer to prevent expensive mouldings from falling off.



4 fl. Oz.

J&B #	CONTAINER	QTY
IES70774	DAUBER	EA

12 in a case

CONFORM TAPE

Premium

Double-Sided Acrylic Foam Tape

- Acrylic foam / high-strength acrylic adhesive.
- Repositional.
- Closed-cell acrylic foam for clean cutting.
- Isolates and dampens vibration and shock.
- Maintains adhesion at sub-zero temperatures.
- Conforms to irregular substrates.
- Applications: Body side mouldings, accessories, emblems, garnish mouldings, rocker panel mouldings, interior trim panels.



J&B #	SIZE	THICKNESS	COLOR	QTY
IES70879	1/4" x 54 Ft.	3/64"	GRAY	EA
IES70880	1/2" x 54 Ft.	3/64"	GRAY	EA
IES70887	3/4" x 54 Ft.	3/64"	GRAY	EA

4 in a case

PARTS FOR GM LOCKS

TUMBLERS, SPRINGS, RETAINERS

J&B #	DESCRIPTION	QTY
13690	Retainer	25
13691	Spring	100
13692	Tumbler # 1	100
13693	Tumbler # 2	100
13694	Tumbler # 3	100
13695	Tumbler # 4	100
13696	Tumbler # 5	100



(Retainer)

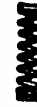

(Spring)



(Tumbler)

KEYS

BLANK METAL ENGRAVING & STAMPING TAGS

Brass

- Each has a hole for fastening with finishing nails or screws.
- 18 ga./040" thick.

J&B #	TAG SIZE	HOLE DIA.	QTY
V58002	1-1/4"	3/16	10
V58001	1-1/2"	3/16	10



KEY EQUIPMENT

KEY DEPTH GAUGE

J&B #	ILCO	APPLICATION
SP	DG-FO-MA	FORD, MAZDA, FESTIVA
SP	DG-GM-CH	GENERAL MOTORS, CHRYSLER

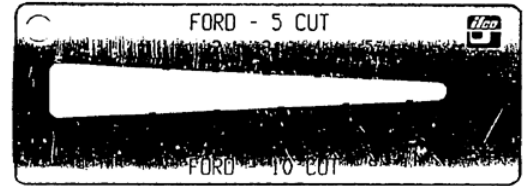

NON-STOCK

KEY RINGS

- Spring tempered steel.
- Nickel Plated.



J&B #	CENTER TO CENTER SIZE	QTY
41308	1"	100

KEY EQUIPMENT

NYLON BRUSH

- Replacement for most Ilco Unican, Taylor Lock, and Dominion Lock machines.

J&B #	ILCO #	SIZE	ARBOR HOLE	QTY
28466	814-00-51	3"	1/2"	EA



FINE MILL CUTTER

- Fine, closely spaced teeth.
- Smooth cutting action.
- Greater service life compared to the rotary fily-type cutter.
- Used on machines:
Taylor: KD1, KD1A, KD5, KD6, KD6A6, KD8, KD9.
Ilco: 2177-ID, 2179-IM, 2175-IA, 178U.
O.L.: 125, 125A, 126, 126M, 136, 136D, 146, 146D.



J&B #	ILCO #	MATERIAL	DIAMETER	THICKNESS	HOLE DIA.	QTY
28467	CU1	Tool Steel	2.25"	.25"	.5"	EA

KEYS

J&B #	APPLICATION	PICTURE PAGE #
2269	GM-E	1086
2271	GM-H	1086
2532	GM-B	1086
2571	GM-A	1086
2946	GM-D	1086
KEY 1069	CABINET, CHRYSLER HUDSON, NATIONAL	1086
KEY 1092	MASTER/DEXTER	1086
KEY 1092N	MASTER/DEXTER	1086
KEY 1092V	MASTER/DEXTER	1086
KEY 1098DB	AMERICAN MOTORS BRIGGS & STRATTON RENAULT	1086
KEY 1098M	BRIGGS & STRATTON FREIGHTLINER MACK	1086
KEY 1145	SCHLAGE 5 PIN	1086
KEY 1176	DONNER	1086
KEY 1184FD	FORD	1087
KEY 1191ET	FORD	1087
KEY 1193FD	FORD	1087
KEY 1196FD	FORD	1087
KEY 320433	CHRYSLER	1087
KEY 320560	AMERICAN MOTORS INTERNATIONAL	1087
KEY B102-P	GENERAL MOTORS	1087
KEY B102GCP	GENERAL MOTORS	1087
KEY B106-P	SATURN	1087
KEY B86-P	GM	1087
KEY B86GP	GM	1087
KEY B88-P	SATURN	1087
KEY B89-P	GM	1088
KEY B89GP	GM	1088
KEY B91-P	CHEVROLET	1088
KEY B91GCP	GM	1088
KEY B96-P	SATURN	1088

J&B #	APPLICATION	PICTURE PAGE #
KEY H1098M	GM PETERBILT VOLKSWAGEN	1088
KEY H65-P	FORD	1088
KEY H67-P	FORD	1088
KEY H75-P	FORD, MERCURY	1088
KEY H76-P	FORD	1088
KEY H78-P	FORD	1088
KEY H84-PT	FORD	
KEY O1122A	CESSNA, FREIGHT PIPER AIRCRAFT	1089
KEY P1098C	GM	1089
KEY P1099	GM	1089
KEY P1101	GM	1089
KEY P1107	GM (P1103)	1089
KEY P1110	SATURN	1089
KEY P1111	GM	1089
KEY P1112	GM	1089
KEY P1793	CHRYSLER	1089
KEY P1794	CHRYSLER	1089
KEY P1795	CHRYSLER	1089
KEY S1098WH	GM	1089
KEY S1105	GM	1089
KEY S1167FD	FORD	1089
KEY S1181FD	FORD	1090
KEY X138	HONDA	1090
KEY X170	FORD, KENWORTH PETERBILT, ROVER STERLING	1090
KEY X176	CHRYSLER	1090
KEY X186	SUZUKI	1090
KEY X217	TOYOTA	1090
KEY X237	NISSAN	1090
KEY X53	KENWORTH, PETERBILT, VOLKSWAGEN	
KEY Y154-P	CHRYSLER	1090
KEY Y157-P	CHRYSLER	1090
KEY Y157PCHY	CHRYSLER, DODGE	1090
KEY Y159-P	CHRYSLER 1995	1090
KEY Y160-PT	CHRYSLER	

- * P stands for plastic head. PC stands for color plastic head.
- * Key part numbers ending in "P" or "PC" will have box quantities of 25.
- * All other key part numbers will have box quantities of 50.
- * **Keys in bold contain a transponder chip with a preloaded factory code.**



KEYS

VATS KEYS

- Single sided.
- Original GM Stratec brand.

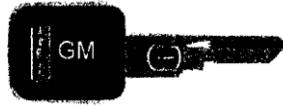

J&B #	SIZE	GM #	STRATEC #	QTY
ZZNSVATS1	#1	26019391	595511	EA
ZZNSVATS2	#2	26019392	595512	EA
ZZNSVATS3	#3	26019393	595513	EA
ZZNSVATS5	#5	26019395	595515	EA
ZZNSVATS6	#6	26019396	595516	EA
ZZNSVATS7	#7	26019397	595517	EA
ZZNSVATS8	#8	26019398	595518	EA
ZZNSVATS9	#9	26019399	595519	EA
ZZNSVATS11	#11	26019401	595521	EA
ZZNSVATS12	#12	26019402	595522	EA
ZZNSVATS13	#13	26019403	595523	EA
ZZNSVATS14	#14	26019404	595524	EA
ZZNSVATS15	#15	26019405	595525	EA

KEYS

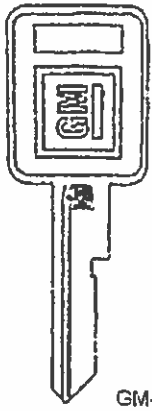

GM

GM-E

Original Equipment



GM

GM-H

Original Equipment



GM

GM-B

Original Equipment

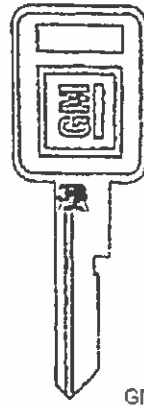

GM

GM-A

Original Equipment

2269

2271

2532

2571



GM

GM-D

Original Equipment

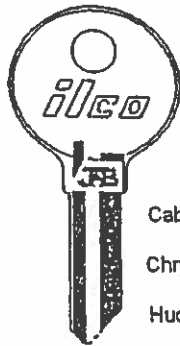

Cabinet
Chrysler
Hudson
National



Master/
Dexter

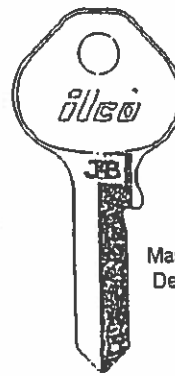

Master/
Dexter

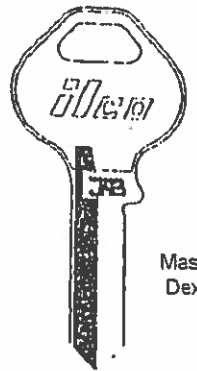

Master/
Dexter

2946

KEY 1069

KEY 1092

KEY 1092N

KEY 1092V

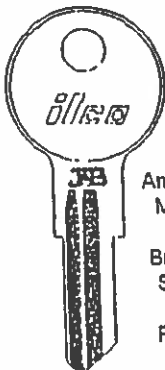

American
Motors
Briggs &
Stratton
Renault

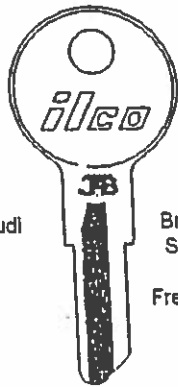

Audi

Briggs &
Stratton
Freightliner
Mack

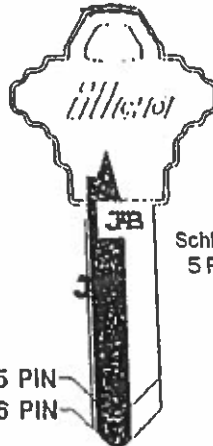

Schlage
5 Pin

5 PIN
6 PIN

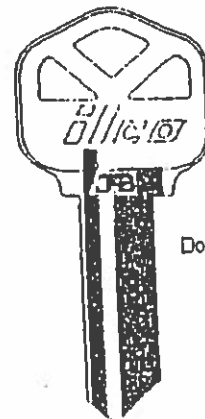

Donner

KEY 1098DB

KEY 1098M

KEY 1145

KEY 1176



KEYS

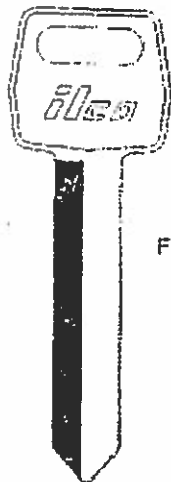

Ford

KEY 1184FD



FORD

KEY 1191ET



FORD

KEY 1193FD

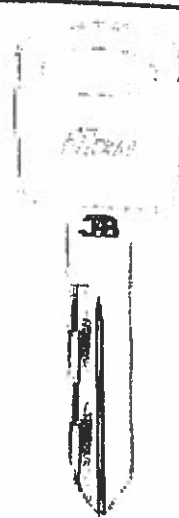

FORD

KEY 1196FD

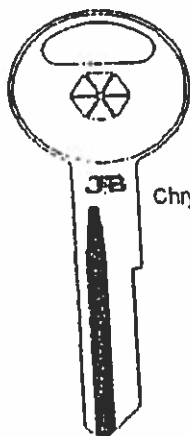

Chrysler

KEY 320433

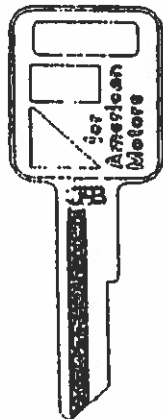

American
Motors
International

KEY 320560

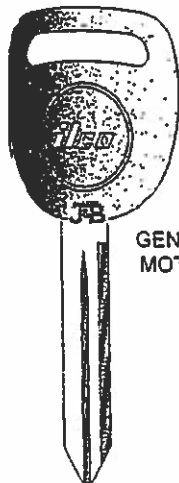

GENERAL
MOTORS

KEY B102-P

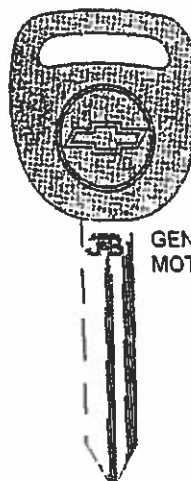

GENERAL
MOTORS

KEY B102GCP

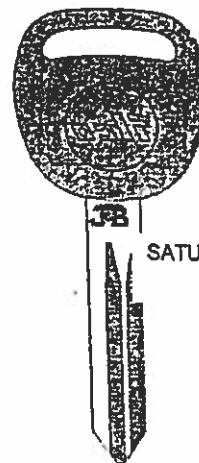

SATURN

KEY B106-P

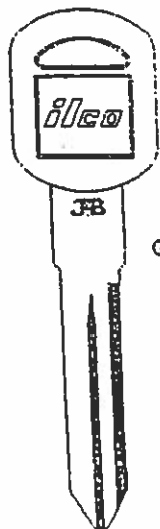

GM

KEY B86-P

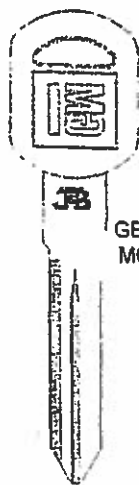

GENERAL
MOTORS

KEY B86GP



Saturn

KEY B88-P



KEYS

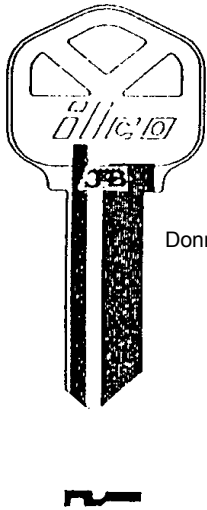

Donner

KEY 1176

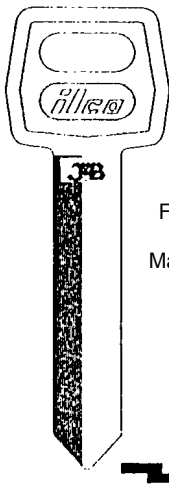

Ford
Mazda

KEY H54-PC

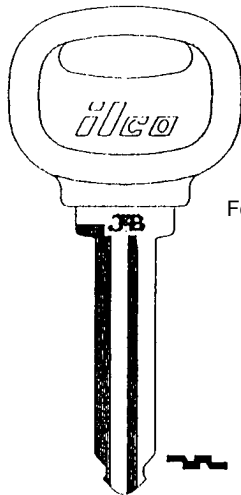

Ford

KEY H59-P

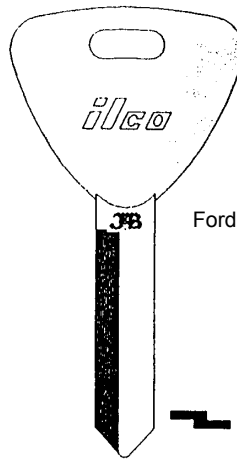

Ford

KEY H62-P

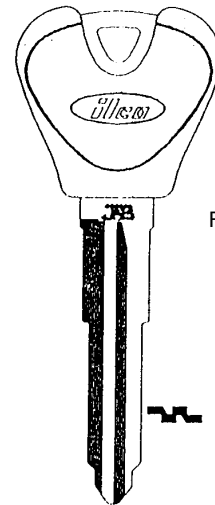

Ford

KEY H65-P

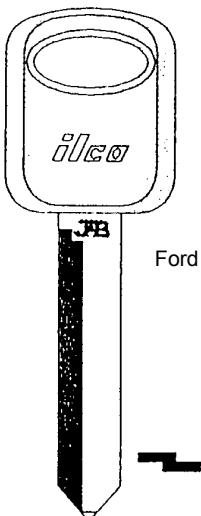

Ford

KEY H67-P

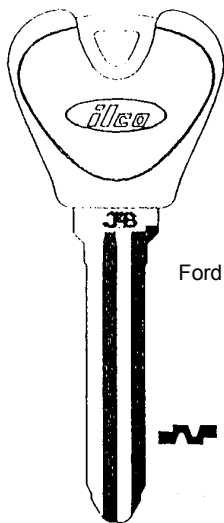

Ford

KEY H70-P

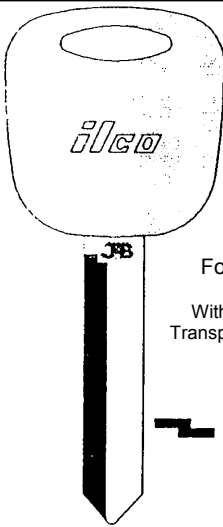

Ford
Without
Transponder

KEY H71-P

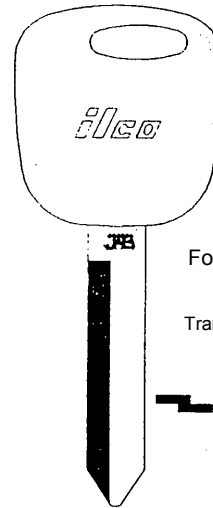

Ford 1996
With
Transponder

KEY H73-PT

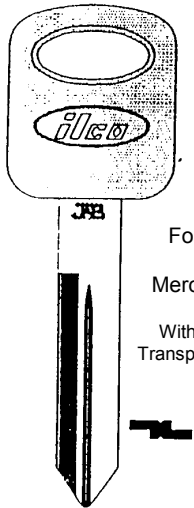

Ford
Mercury
Without
Transponder

KEY H75-P

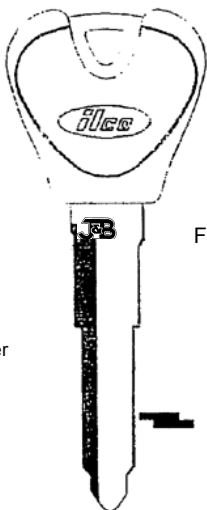

Ford

KEY H76-P

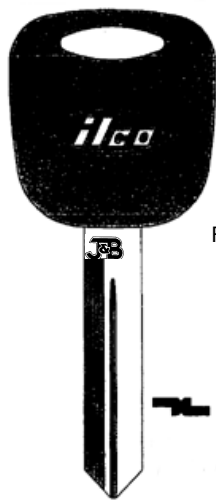

Ford

KEY H78-P

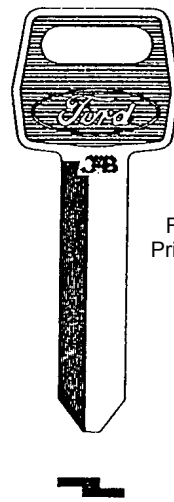

Ford
Primary

KEY H51F

KEYS

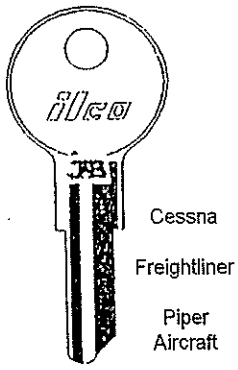

KEY O1122A

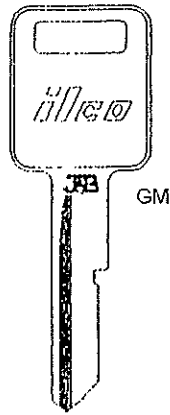

KEY P1098C

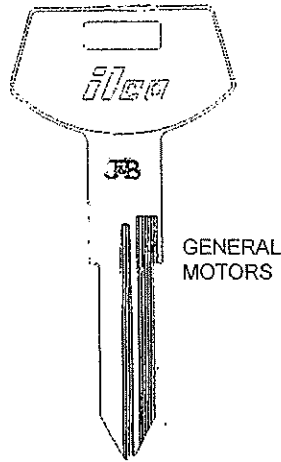

KEY P1099

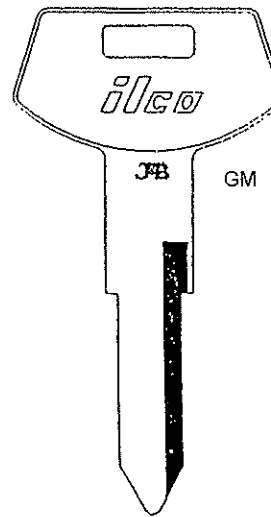

KEY P1101

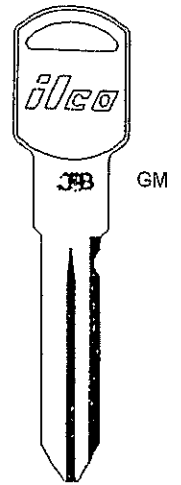

KEY P1107

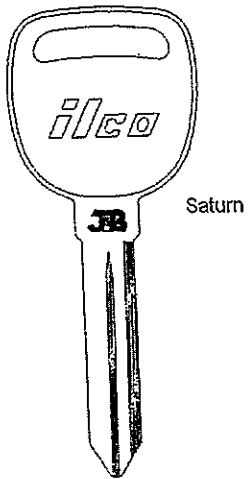

KEY P1110

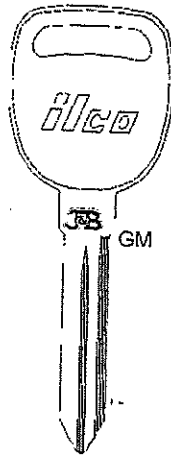

KEY P1111

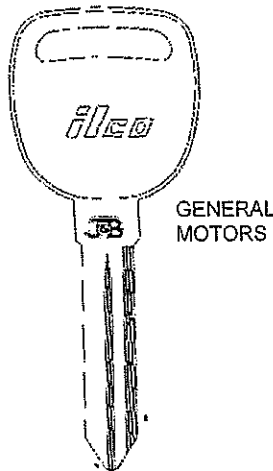

KEY P1112

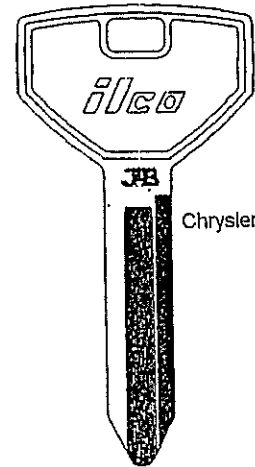

KEY P1793

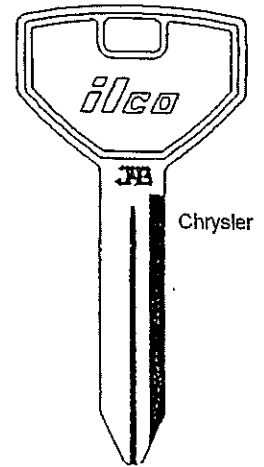

KEY P1794

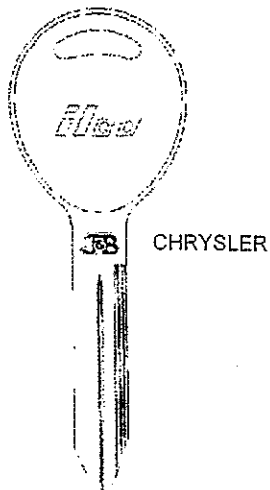

KEY P1795

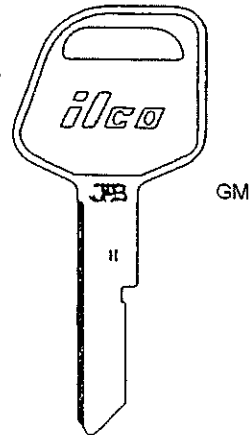

KEY S1098WH

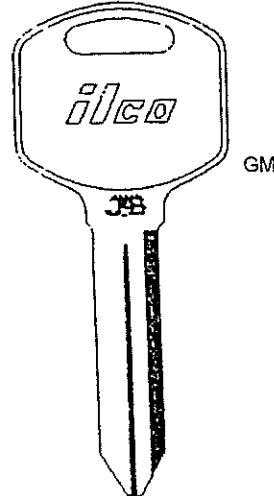

KEY S1105

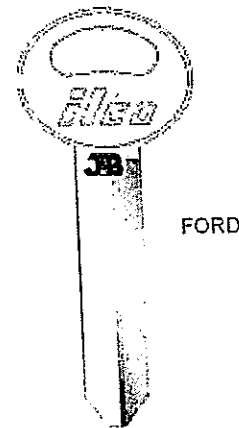

KEY S1167FD



KEYS



FORD

KEY S1181FD

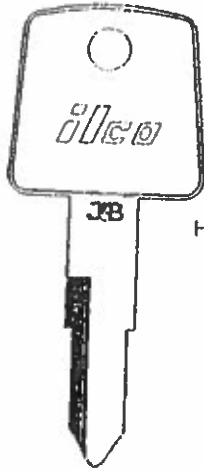

Honda

KEY X138

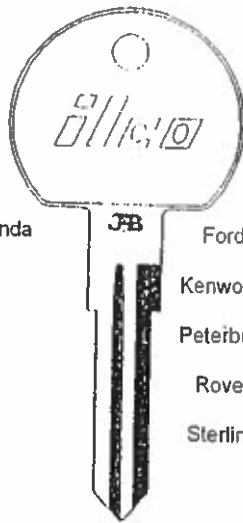

Ford
Kenworth
Peterbilt
Rover
Sterling

KEY X170



CHRYSLER

KEY X176

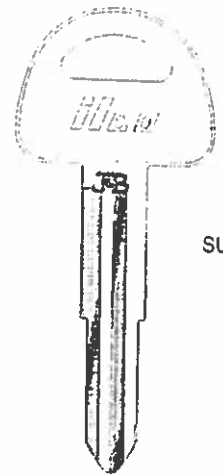

SUZUKI

KEY X186



TOYOTA

KEY X217



NISSAN

KEY X237

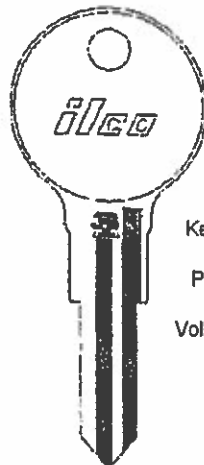

Kenworth
Peterbilt
Volkswagen

KEY X53

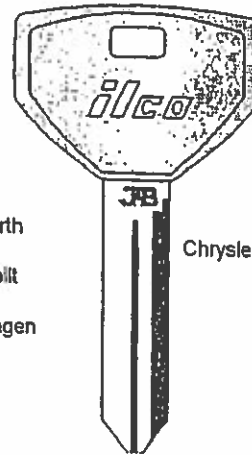

Chrysler

KEY Y154-P

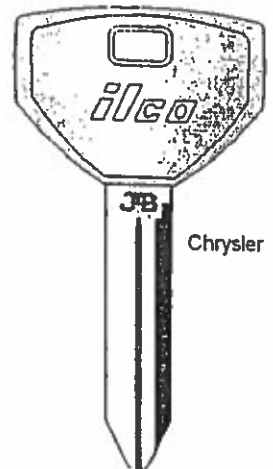

Chrysler

KEY Y157-P

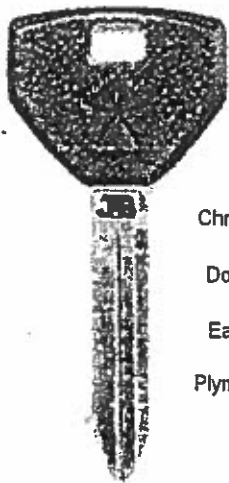

Chrysler
Dodge
Eagle
Plymouth

KEY Y157PCHY

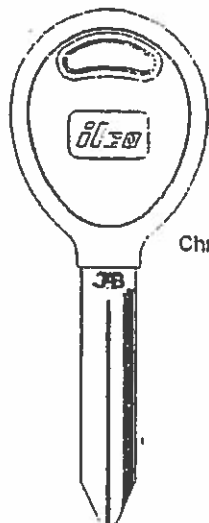

Chrysler

KEY Y159-P

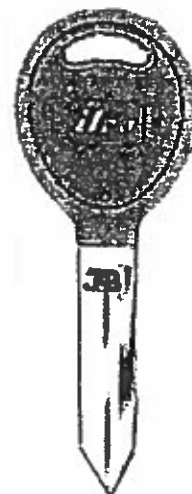

Chrysler
Dodge
Jeep

KEY Y160-PT



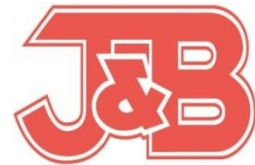
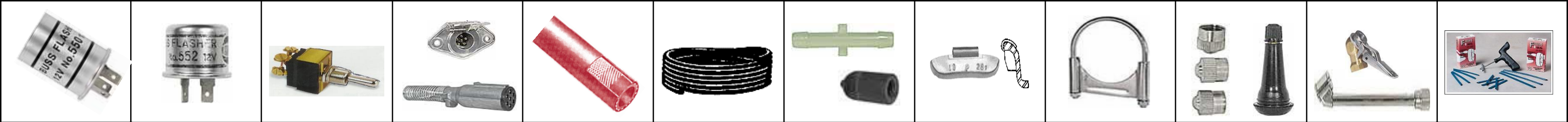















J&B Fleet - Industrial Supply

www.jbfleet.com

22428 Harrisburg-Westville Rd. Alliance, Ohio 44601 Phone: (330) 821-6342 Fax: (330) 821-0411

PART#2862

FUEL LINE CONNECTORS

 <p>FM3394C 2 5/16 ST PUSH CONN TO 8MM 5/16 LINE</p>	 <p>FM3391C 2 3/8 ST PUSH CONN TO 10MM 3/8 LINE</p>	 <p>FM2940 10 6MM 1/4 CLAMP</p>	 <p>FM3204 2 6MM 1/4 BRASS TO 8MM 5/16 REDUCER</p>
 <p>FM3403C 2 5/16 ST PUSH CONN TO 1/4 LINE</p>	 <p>FM2994 2 6MM 1/4 BRASS UNION</p>	 <p>FM2980 10 8MM 5/16 CLAMP</p>	 <p>FM3392C 2 5/16 90° PUSH CONN TO 10MM 3/8 LINE</p>
 <p>FM3393C 2 5/16 ST PUSH CONN TO 10MM 3/8 LINE</p>	 <p>FM2959 2 8MM 5/16 BRASS UNION</p>	 <p>FM2982 10 10MM 3/8 CLAMP</p>	 <p>FM3390C 2 3/8 90° PUSH CONN TO 10MM 3/8 LINE</p>
 <p>FM3395C 2 10MM ST PUSH CONN TO 10MM LINE FOR JAPANESE CARS</p>	 <p>FM2968 2 10MM 3/8 BRASS UNION</p>	 <p>FM3205 2 8MM 5/16 BRASS TO 10MM 3/8 REDUCER</p>	



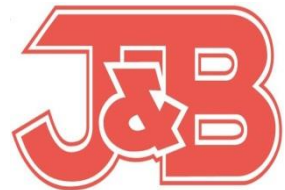

J&B Fleet - Industrial Supply

















22428 Harrisburg-Westville Rd. Alliance, Ohio 44601 Phone: (330) 821-6342 Fax: (330) 821-0411

www.jbfleet.com

PART#2864

FUEL LINE FITTINGS



<p>FM4237</p>  <p>5/16-8MM x 14MM FEMALE COUPLING</p> <p>1</p>	<p>FM4236</p>  <p>3/8-10MM x 16MM FEMALE COUPLING</p> <p>1</p>		<p>FM2842</p>  <p>10MM TO 3/8 REDUCER UNION</p> <p>4</p>
<p>FM2856</p>  <p>1/4 COMPRESSION UNION NYLON STEEL COPPER</p> <p>2</p>	<p>FM2857</p>  <p>5/16 COMPRESSION UNION NYLON STEEL COPPER</p> <p>2</p>	<p>FM2858</p>  <p>3/8 COMPRESSION UNION NYLON STEEL COPPER</p> <p>2</p>	<p>FM2859</p>  <p>10MM COMPRESSION UNION NYLON STEEL COPPER</p> <p>2</p>
<p>FM3135L</p>  <p>3/8 x 6 WITH 16MM NUT</p> <p>2</p>		<p>FM3135</p>  <p>3/8 x 3-3/4 WITH 14MM NUT</p> <p>2</p>	<p>FM3133</p>  <p>3/8 x 3-3/4 NYLON TO RUBBER</p> <p>2</p>
<p>FM3119L</p>  <p>5/16 x 6 WITH 14MM NUT</p> <p>2</p>		<p>FM3119</p>  <p>5/16 x 3-3/4 WITH 14MM NUT</p> <p>2</p>	<p>FM3122</p>  <p>5/16 x 3-3/4 NYLON TO RUBBER</p> <p>1</p>
<p>FM2963CVT</p>  <p>10MM x 10.5" FLEX TUBE 3/8"</p> <p>1</p>		<p>FM3134</p>  <p>3/8 x 3-3/4 PUSH TO CONNCT 10MM</p> <p>2</p>	
<p>FM2962CVT</p>  <p>8MM x 10.5" FLEX TUBE 5/16"</p> <p>1</p>		<p>FM3118</p>  <p>5/16 x 3-3/4 PUSH TO CONNECT 8MM</p> <p>2</p>	



LET US HELP YOU MAKE THE CONNECTION



PART#3104

FMSI FUEL FITTING KIT

J & B FLEET-INDUSTRIAL SUPPLY
PHONE: 330-821-6342

FM3390C 3/8" x 3/8" 90° 2	FM3391C 3/8" x 3/8" STRAIGHT 2	FM3392C 5/16" x 3/8" 90° 2	FM3393C 5/16" x 3/8" STRAIGHT 2		FM3394C 5/16" x 5/16" STRAIGHT 2
FM2959 5/16" NYLON TUBE JOINER 2	FM2968 10MM NYLON TUBE JOINER 2	FM2980 5/16"- 18MM FUEL LINE CLAMP 2	FM2982 3/8"-10MM FUEL LINE CLAMP 2	FM2942 5/16"- 8MM NYLON TO STEEL 2	FM2943 3/8"- 10MM NYLON TO STEEL 2

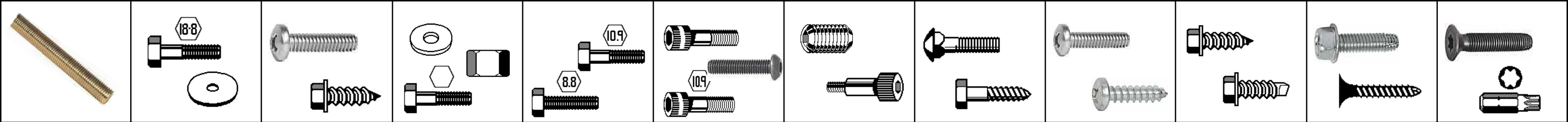











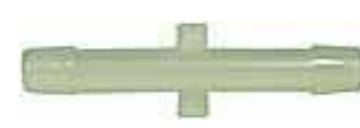









J&B Fleet - Industrial Supply

www.jbfleet.com

22428 Harrisburg-Westville Rd. Alliance, Ohio 44601 Phone: (330) 821-6342 Fax: (330) 821-0411

PART # 2012

HOSE CONNECTORS

<p>1 20857</p>  <p>5 1/8" CONNECTOR</p>	<p>2 20858</p>  <p>5 3/16" CONNECTOR</p>	<p>3 20859</p>  <p>5 1/4" CONNECTOR</p>	<p>4 20860</p>  <p>5 5/16" CONNECTOR</p>	<p>5 20864</p>  <p>5 3/8" CONNECTOR</p>
<p>7 20867</p>  <p>5 5/32" TEE</p>	<p>8 20868</p>  <p>5 3/16" TEE</p>	<p>9 20869</p>  <p>5 1/4" TEE</p>	<p>10 32336</p>  <p>5 5/16" TEE</p>	<p>11 32337</p>  <p>5 3/8" TEE</p>
<p>13 20865</p>  <p>5 1/4 " X 3/16 " REDUCER</p>	<p>14 20866</p>  <p>5 3/8 " X 1/4 " REDUCER</p>	<p>15 32332</p>  <p>5 1/8" CAP</p>	<p>16 11597</p>  <p>5 3/16" CAP</p>	<p>17 11596</p>  <p>5 1/4" CAP</p>
<p>19 32333</p>  <p>5 5/16" CAP</p>	<p>20 32334</p>  <p>5 3/8" CAP</p>	<p>21 32335</p>  <p>5 1/2" CAP</p>	<p>22 32338</p>  <p>5 5/8" CAP</p>	<p>23 11598</p>  <p>5 1/4" CAP</p>



LET US HELP YOU MAKE THE CONNECTION

PART # 3040



VACUUM CONNECTORS



J & B FLEET-INDUSTRIAL SUPPLY
PHONE: 330-821-6342

20857 1/8 UNION 5	20858 3/16 UNION 5	20859 1/4 UNION 5	20860 5/16 UNION 3	20864 3/8 UNION 3	11597 3/16 CAP 5
20867 1/8 TEE 5	20868 3/16 TEE 5	20869 1/4 TEE 5	20865 1/4 X 3/16 REDUCER 5	20866 3/8 X 1/4 REDUCER 5	11596 1/4 CAP 5



J&B Fleet - Industrial Supply



22428 Harrisburg-Westville Rd. Alliance, Ohio 44601 Phone: (330) 821-6342 Fax: (330) 821-0411

www.jbfleet.com

PART # 2122

VACUUM CONNECTORS



<p>40514 1</p> <p>OEM # 25517954</p> <p>90 ELBOW</p> <p>5</p>	<p>40520 2</p> <p>OEM # 22518857</p> <p>TEE</p> <p>5</p>	<p>50502 9</p>  <p>1/8 NTA TUBE</p> <p>25 FT</p>	<p>50503 10</p>  <p>5/32 NTA TUBE</p> <p>25 FT</p>
<p>40512 3</p> <p>OEM # 12047609</p> <p>STRAIGHT</p> <p>5</p>	<p>40517 4</p> <p>OEM # 12059749</p> <p>90 ELBOW</p> <p>5</p>		
	<p>40516 6</p> <p>OEM # 14084916</p> <p>90 ELBOW</p> <p>5</p>		
<p>40510 7</p> <p>OEM # 25517507</p> <p>STRAIGHT</p> <p>5</p>	<p>40515 8</p> <p>OEM # 4213774</p> <p>90 ELBOW</p> <p>5</p>		

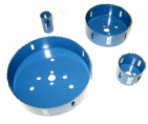

LET US HELP YOU MAKE THE CONNECTION



J & B FLEET-INDUSTRIAL SUPPLY
PHONE: 330-821-6342

PART#3109

SOLDER PELLET

56978



4G

10/BX

3

4 GA GRAY

56979



2G

10/BX

3

2 GA GREEN

56980



**1 GA
RED**

3

56981



**1/0 G
10/BX**

**1/0
BLACK**

3

56982



**2/0 G
10/BX**

**2/0
ORANGE**

3

56983



**3/0G
10/BX**

**3/0
PURPLE**

3

56984



**4/0 Ga
10/Bx**

**4/0
YELLOW**

3

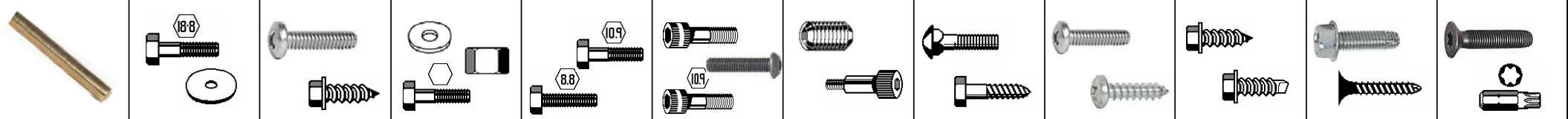











J&B Fleet - Industrial Supply

22428 Harrisburg-Westville Rd. Alliance, Ohio 44601 Phone: (330) 821-6342 Fax: (330) 821-0411

www.jbfleet.com

PART # 2083

HEAVY DUTY TERMINALS

1	40192 2  2/0 1/2 STUD HEAVY DUTY LUG 2	3	4	5	TOOL STORAGE 21 39172 	
6	40186 6  1/0 3/8 STUD HEAVY DUTY LUG 2	7	40168 8  2/0 HEAVY DUTY SPLICE 2	9		10
11	40190 12  2/0 3/8 STUD HEAVY DUTY LUG 2	13	39154 14  2/0 NEGATIVE TERMINAL 2	14		39166 15  2/0 NEGATIVE RIGHT ANGLE 1
16	40180 16  2 GA 3/8 STUD HEAVY DUTY LUG 1	17	40160 18  4 GA HEAVY DUTY SPLICE 1	18		39153 19  2/0 POSITIVE TERMINAL 2
				19		39165 20  2/0 POSITIVE RIGHT ANGLE 1





J&B Fleet - Industrial Supply

22428 Harrisburg-Westville Rd. Alliance, Ohio 44601 Phone: (330) 821-6342 Fax: (330) 821-0411

www.jbfleet.com

PART # 2081

HEAVY DUTY TERMINALS

1	 <p>40192 2</p> <p>2/0 1/2 STUD 2 HEAVY DUTY LUG</p>	3	4	5	<p>TOOL STORAGE ²¹</p>	
6	 <p>40186 6</p> <p>1/0 3/8 STUD 2 HEAVY DUTY LUG</p>	7	 <p>40168 8</p> <p>2/0 HEAVY DUTY SPLICE</p>	9		10
11	 <p>40190 12</p> <p>2/0 3/8 STUD 2 HEAVY DUTY LUG</p>	13	 <p>39154 14</p> <p>2/0 NEGATIVE TERMINAL</p>	15		 <p>39166 15</p> <p>2/0 NEGATIVE RIGHT ANGLE</p>
16	 <p>40180 16</p> <p>2 GA 3/8 STUD 1 HEAVY DUTY LUG</p>	17	 <p>40160 18</p> <p>4 GA HEAVY DUTY SPLICE</p>	19		 <p>39153 19</p> <p>2/0 POSITIVE TERMINAL</p>
		20	 <p>39165 20</p> <p>2/0 POSITIVE RIGHT ANGLE</p>			



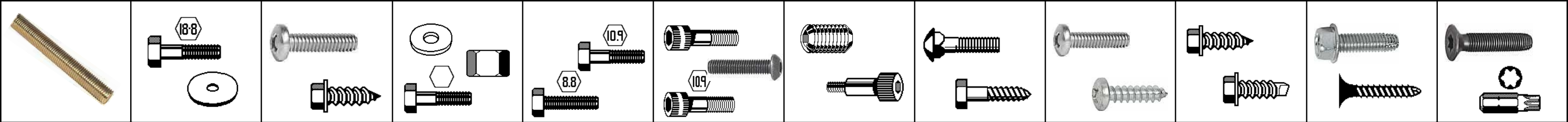

























J&B Fleet - Industrial Supply
 22428 Harrisburg-Westville Rd. Alliance, Ohio 44601 Phone: (330) 821-6342 Fax: (330) 821-0411

www.jbfleet.com

PART # 2298

HEAVY DUTY LUGS



 <p>40519¹ #6 BUTT SPLICE</p>	 <p>40160² #4 BUTT SPLICE</p>	 <p>40162³ #2 BUTT SPLICE</p>	 <p>40197⁴ 4/0-3/8 LUG</p>	 <p>40198⁵ 4/0-1/2 LUG</p>	 <p>40172⁶ 4/0 BUTT SPLICE</p>
 <p>40490⁷ #6-3/8 LUG</p>	 <p>40493⁸ #4-3/8 LUG</p>	 <p>40180⁹ #1-2 3/8 LUG</p>	 <p>40195¹⁰ 3/0-3/8 LUG</p>	 <p>40196¹¹ 3/0-1/2 LUG</p>	 <p>40170¹² 3/0 BUTT SPLICE</p>
 <p>40489¹³ #6-5/16 LUG</p>	 <p>40492¹⁴ #4-5/16 LUG</p>	 <p>40487¹⁵ #1-2 5/16 LUG</p>	 <p>40190¹⁶ 2/0-3/8 LUG</p>	 <p>40192¹⁷ 2/0-1/2 LUG</p>	 <p>40168¹⁸ 2/0 BUTT SPLICE</p>
 <p>40488¹⁹ #6-1/4 LUG</p>	 <p>40491²⁰ #4-1/4 LUG</p>	<p>40186²¹</p>  <p>1/0-3/8 LUG</p>	 <p>40188²² 1/0-1/2 LUG</p>	 <p>40188²³ 1/0-1/2 LUG</p>	 <p>40166²⁴ 1/0 BUTT SPLICE</p>

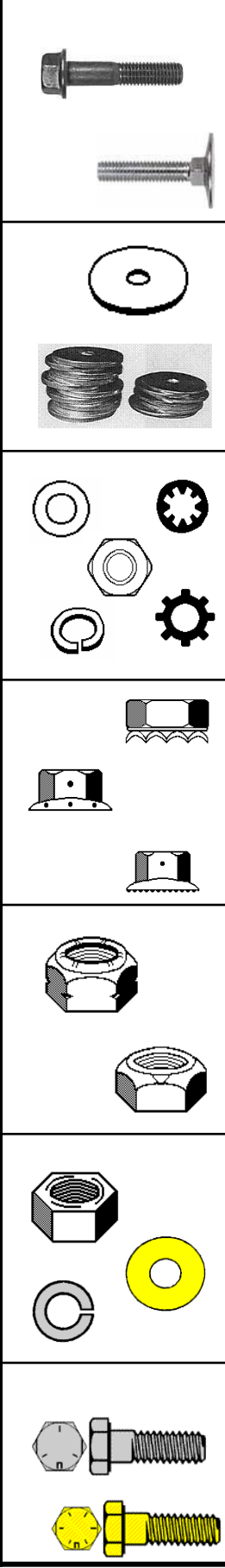

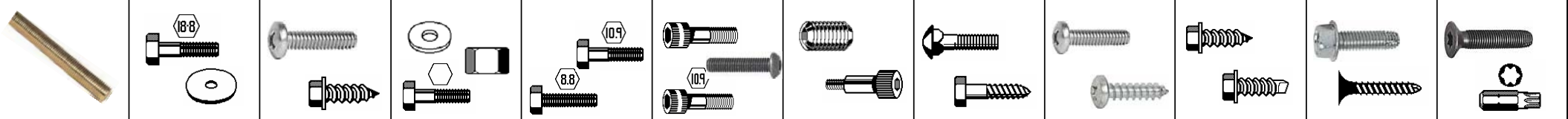



















J&B Fleet - Industrial Supply

22428 Harrisburg-Westville Rd. Alliance, Ohio 44601 Phone: (330) 821-6342 Fax: (330) 821-0411

www.jbfleet.com

PART # 2219

BATTERY TERMINALS

<p>40180 ¹</p>  <p>1-2 GA - 3/8 STUD</p> <p>³</p>	<p>40186 ²</p>  <p>1/0 - 3/8 STUD</p> <p>³</p>	<p>40188 ³</p>  <p>1/0 - 1/2 STUD</p> <p>³</p>	<p>40190 ⁴</p>  <p>2/0 - 3/8 STUD</p> <p>²</p>	<p>40192 ⁵</p>  <p>2/0 - 1/2 STUD</p> <p>²</p>	<p>40195 ⁶</p>  <p>3/0 - 3/8 STUD</p> <p>¹</p>
<p>40160 ⁷</p>  <p>4 GA SPLICE</p> <p>³</p>	<p>40162 ⁸</p>  <p>2 GA SPLICE</p> <p>³</p>	<p>40166 ⁹</p>  <p>1/0 SPLICE</p> <p>³</p>	<p>40168 ¹⁰</p>  <p>2/0 SPLICE</p> <p>²</p>	<p>40170 ¹¹</p>  <p>3/0 SPLICE</p> <p>¹</p>	<p>40196 ¹²</p>  <p>3/0 - 1/2 STUD</p> <p>¹</p>
<p>20476 ¹³</p>  <p>4 GA - 3/8 STUD</p> <p>⁴</p>	<p>20477 ¹⁴</p>  <p>2 GA - 3/8 STUD</p> <p>⁴</p>	<p>22190 ¹⁵</p>  <p>1/0 - 3/8 STUD</p> <p>⁴</p>	<p>20478 ¹⁶</p>  <p>2/0 - 3/8 STUD</p> <p>²</p>	<p>20479 ¹⁷</p>  <p>2/0 - 1/2 STUD</p> <p>²</p>	<p>22196 ¹⁸</p>  <p>3/0 - 1/2 STUD</p> <p>¹</p>
<p>¹⁹</p>	<p>²⁰</p>	<p>²¹</p>	<p>²²</p>	<p>²³</p>	<p>²⁴</p>

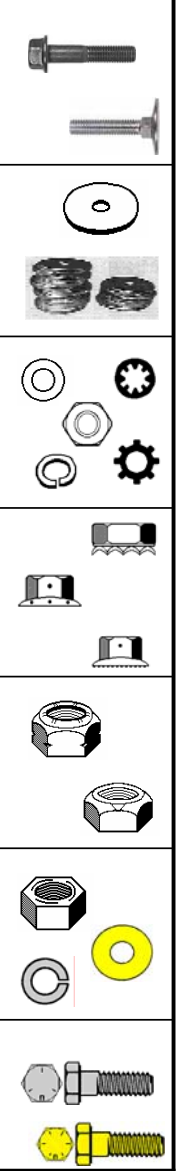

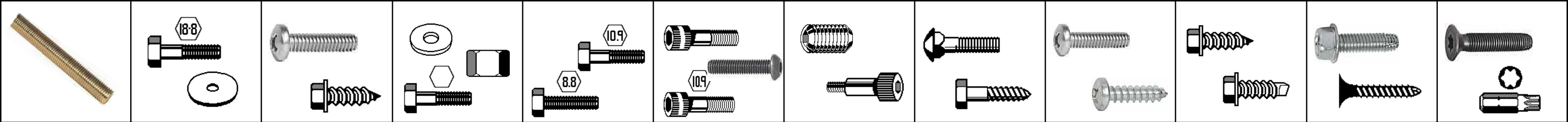

























J&B Fleet - Industrial Supply

22428 Harrisburg-Westville Rd. Alliance, Ohio 44601 Phone: (330) 821-6342 Fax: (330) 821-0411

www.jbfleet.com

PART# 2807

BATTERY CABLE LUGS

 55802 8 GA 1/4 STUD	 55810 8 GA 5/16 STUD	 55811 8 GA 3/8 STUD	 55813 6 GA 1/4 STUD	 55814 6 GA 5/16 STUD	 20479 2 / O 1/2 STUD
 55815 6 GA 3/8 STUD	 55817 4 GA 1/4 STUD	 55818 4 GA 5/16 STUD	 20476 4 GA 3/8 STUD	 55819 4 GA 1/2 STUD	 20478 2 / O 3/8 STUD
 55824 2 GA 1/4 STUD	 55825 2 GA 5/16 STUD	 20477 2 GA 3/8 STUD	 55826 2 GA 1/2 STUD	 55821 1 GA 5/16 STUD	 55829 2 / O 5/16 STUD
 55822 1 GA 3/8 STUD	 55823 1 GA 1/2 STUD	 55827 1 / O 5/16 STUD	 22190 1 / O 3/8 STUD	 55807 1 / O 1/2 STUD	 55828 2 / O 1/4 STUD

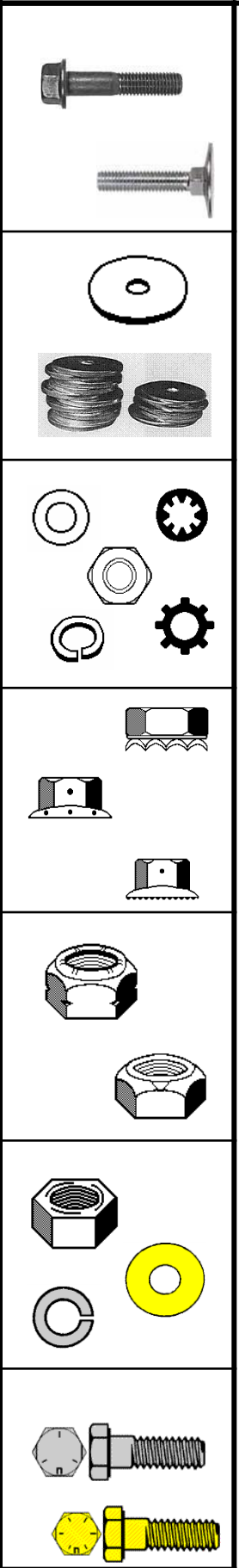

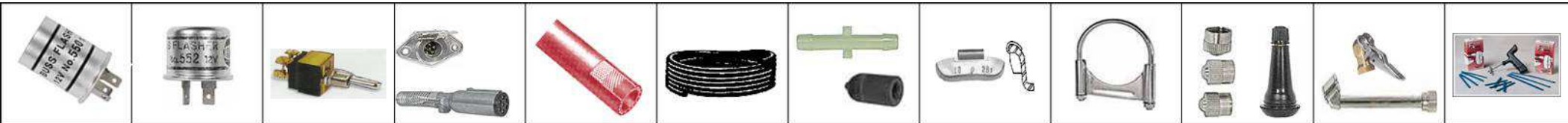









J&B Fleet - Industrial Supply

www.jbfleet.com

22428 Harrisburg-Westville Rd. Alliance, Ohio 44601 Phone: (330) 821-6342 Fax: (330) 821-0411

PART# 2825

ALLIGATOR CLAMPS

<p style="text-align: center;">38500</p>  <p style="text-align: center;">600 AMP</p> <p style="text-align: center;">H/D CABLE CLAMP 600 AMP RED</p> <p style="text-align: center;">2</p>	<p style="text-align: center;">38501</p>  <p style="text-align: center;">600 AMP</p> <p style="text-align: center;">H/D CABLE CLAMP 600 AMP BLACK</p> <p style="text-align: center;">2</p>	<p style="text-align: center;">42080</p>  <p style="text-align: center;">50 AMP MINI BATT CLAMP 50 AMP RED</p> <p style="text-align: center;">3</p> <hr/> <p style="text-align: center;">42082</p>  <p style="text-align: center;">50 AMP MINI BATT CLAMP 50 AMP RED</p> <p style="text-align: center;">3</p> <hr/> <p style="text-align: center;">22456</p>  <p style="text-align: center;">5/BX ALLIGATOR CLIPS INSULATOR RED</p> <p style="text-align: center;">5</p> <hr/> <p style="text-align: center;">22457</p>  <p style="text-align: center;">5/BX ALLIGATOR CLIPS INSULATOR BLACK</p> <p style="text-align: center;">5</p>	<p style="text-align: center;">86090</p>  <p style="text-align: center;">FUSE PULLER</p> <p style="text-align: center;">1</p> <hr/> <p style="text-align: center;">28463</p>  <p style="text-align: center;">5/BX ALLIGATOR CLIPS</p> <p style="text-align: center;">5</p>
--	--	---	--



LET US HELP YOU MAKE THE CONNECTION

PART # 3049



AGC FUSES



J & B FLEET-INDUSTRIAL SUPPLY
PHONE: 330-821-6342

20048 1 AMP 5	20070 2 AMP 5	20052 3 AMP 5	20067 5 AMP 5	42702 7.5 AMP 5	20055 10 AMP 5
20056 15 AMP 5	21262 20 AMP 5	20068 25 AMP 5	20057 30 AMP 5		







































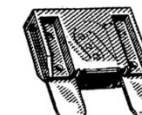





J&B Fleet - Industrial Supply

www.jbfleet.com

22428 Harrisburg-Westville Rd. Alliance, Ohio 44601 Phone: (330) 821-6342 Fax: (330) 821-0411

PART # 2106

FUSES

 5 20048 AGC-1	 5 20056 AGC-15	 5 20064 SFE-20	 5 38606 MINI-ATM-7-1/2	 5 38921 ATC-1	 5 38623 ATC-10		 2 42176 MAXI 20
 5 20070 AGC-2	 5 21262 AGC-20	 5 20065 SFE-30	 5 38607 MINI-ATM-10	 5 38922 ATC-2	 5 38624 ATC-15		 2 42178 MAXI 30
 5 20052 AGC-3	 5 20068 AGC-25	 5 38601 MINI-ATM-2	 5 38608 MINI-ATM-15	 5 38620 ATC-3	 5 38625 ATC-20		 2 42180 MAXI 40
 5 20067 AGC-5	 5 20057 AGC-30	 5 38603 MINI-ATM-3	 5 38609 MINI-ATM-20	 5 38923 ATC-4	 5 38626 ATC-25		 2 42182 MAXI 50
 5 42702 AGC-7.5	 5 21264 GBC-16	 5 38604 MINI-ATM-4	 5 38611 MINI-ATM-25	 5 38621 ATC-5	 5 38627 ATC-30		 2 42184 MAXI 60
 5 20055 AGC-10	 5 20063 SFE-14	 5 38605 MINI-ATM-5	 5 38613 MINI-ATM-30	 5 38622 ATC-7-1/2	 5 38924 ATC-40	 2 42175 MAXI 80	 2 42174 MAXI 70













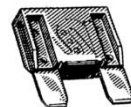

J&B Fleet - Industrial Supply

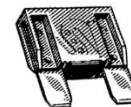
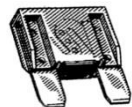
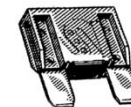
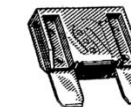
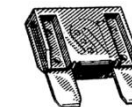
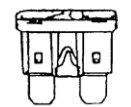
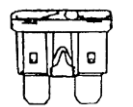
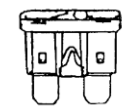
22428 Harrisburg-Westville Rd. Alliance, Ohio 44601 Phone: (330) 821-6342 Fax: (330) 821-0411

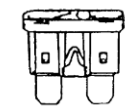
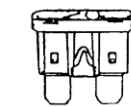
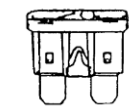
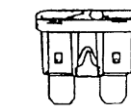
www.jbfleet.com

PART # 2231

BLADE FUSES

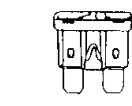
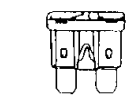
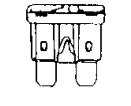
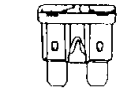
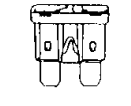
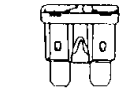
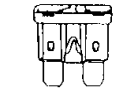
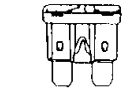
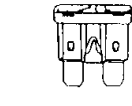
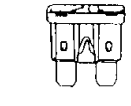
 42176 ¹ MAXI 20 2	 42178 ² MAXI 30 2	 42180 ³ MAXI 40 2	 42182 ⁴ MAXI 50 2	 42184 ⁵ MAXI 60 2	 42174 ⁶ MAXI 70 2	 42175 ⁷ MAXI 80 2	 38921 ⁹ ATC - 1 5	 38922 ¹⁰ ATC - 2 5	 38620 ¹¹ ATC - 3 5	 38923 ¹² ATC - 4 5	 38621 ¹³ ATC - 5 5	 38622 ¹⁴ ATC - 7-1/2 5	 38623 ¹⁵ ATC - 10 5	 38624 ¹⁶ ATC - 15 5
 38625 ¹⁷ ATC - 20 5	 38626 ¹⁸ ATC - 25 5	 38627 ¹⁹ ATC - 30 5	 38924 ²⁰ ATC - 40 5	 38608 ²⁹ MINI ATM - 15 5	 38609 ³⁰ MINI ATM - 20 5	 38601 ²³ MINI ATM - 2 5	 38603 ²⁴ MINI ATM - 3 5							
 38604 ²⁵ MINI ATM - 4 5	 38605 ²⁶ MINI ATM - 5 5	 38606 ²⁷ MINI ATM 7-1/2 5	 38607 ²⁸ MINI ATM - 10 5	 38608 ²⁹ MINI ATM - 15 5	 38609 ³⁰ MINI ATM - 20 5	 38611 ³¹ MINI ATM - 25 5	 38613 ³² MINI ATM - 30 5							

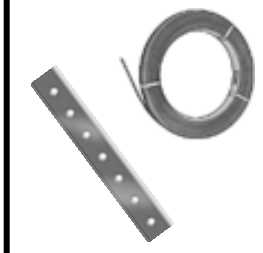

LET US HELP YOU MAKE THE CONNECTION

PART # 3039

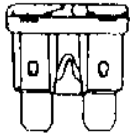

MINI AUTOFUSES



J & B FLEET-INDUSTRIAL SUPPLY
PHONE: 330-821-6342

38601 2 AMP 10	38603 3 AMP 10	38604 4 AMP 10	38605 5 AMP 10	38606 7-1/2 AMP 10	38607 10 AMP 10
38608 15 AMP 10	38609 20 AMP 10	38611 25 AMP 10	38613 30 AMP 10		

LET US HELP YOU MAKE THE CONNECTION

PART # 3037



BLADE FUSES



J & B FLEET-INDUSTRIAL SUPPLY
PHONE: 330-821-6342

38605 MINI ATM - 5 5	38607 MINI ATM - 10 5	38608 MINI ATM - 15 5	38609 MINI ATM - 20 5	38611 MINI ATM - 25 5	38613 MINI ATM - 30 5
38623 ATC - 10 5	38624 ATC - 15 5	38625 ATC - 20 5	38626 ATC - 25 5	38627 ATC - 30 5	38924 ATC - 40 5
38921 ATC - 1 5	38922 ATC - 2 5	38620 ATC - 3 5	38923 ATC - 4 5	38621 ATC - 5 5	38622 ATC - 7-1/2 5

LET US HELP YOU MAKE THE CONNECTION

PART # 3038



AUTOFUSES



J & B FLEET-INDUSTRIAL SUPPLY
PHONE: 330-821-6342

38921 ATC - 1 10	38922 ATC - 2 10	38620 ATC - 3 10	38923 ATC - 4 10	38621 ATC - 5 10	38622 ATC - 7-1/2 10
38623 ATC - 10 10	38624 ATC - 15 10	38625 ATC - 20 10	38626 ATC - 25 10	38627 ATC - 30 10	38924 ATC - 40 10

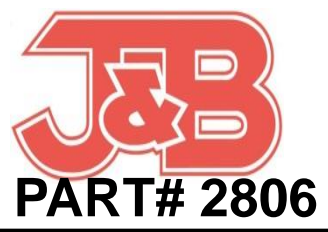
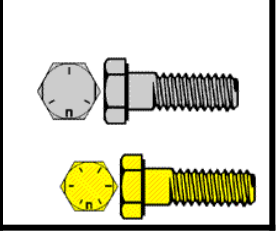
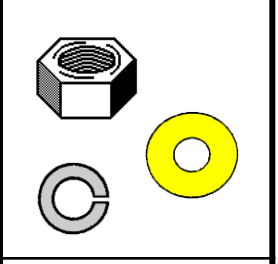
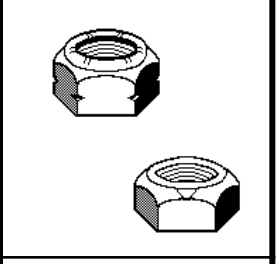
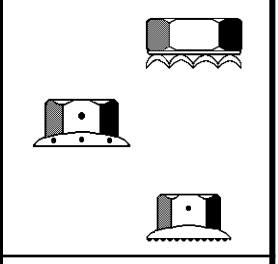
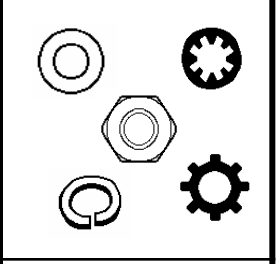
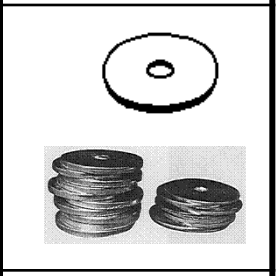
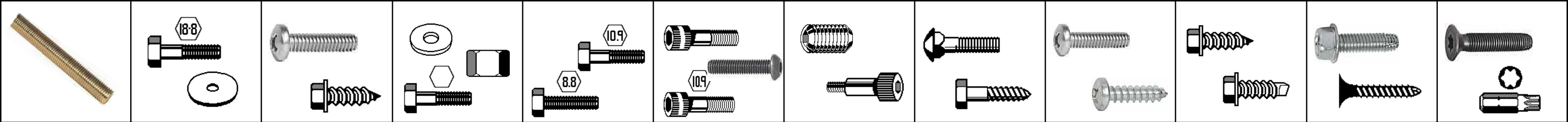

J&B Fleet - Industrial Supply
 22428 Harrisburg-Westville Rd. Alliance, Ohio 44601 Phone: (330) 821-6342 Fax: (330) 821-0411

www.jbfleet.com

SMART GLOW FUSES

<p>57390 1</p>  <p>5 AMP TAN</p> <p>4</p>	<p>57391 2</p>  <p>7-1/2 AMP BROWN</p> <p>4</p>	<p>57392 3</p>  <p>10 AMP RED</p> <p>4</p>	<p>57393 4</p>  <p>15 AMP BLUE</p> <p>4</p>	<p>57394 5</p>  <p>20 AMP YELLOW</p> <p>4</p>	<p>6</p>
<p>57395 7</p>  <p>25 AMP NATURAL</p> <p>4</p>	<p>57396 8</p>  <p>30 AMP GREEN</p> <p>4</p>	<p>9</p>	<p>10</p>	<p>11</p>	<p>12</p>
<p>57400 13</p>  <p>5 AMP MINI TAN</p> <p>4</p>	<p>57401 14</p>  <p>7-1/2 AMP MINI BROWN</p> <p>4</p>	<p>57402 15</p>  <p>10 AMP MINI RED</p> <p>4</p>	<p>57403 16</p>  <p>15 AMP MINI BLUE</p> <p>4</p>	<p>57404 17</p>  <p>20 AMP MINI YELLOW</p> <p>4</p>	<p>18</p>
<p>57405 19</p>  <p>25 AMP MINI NATURAL</p> <p>4</p>	<p>57406 20</p>  <p>30 AMP MINI GREEN</p> <p>4</p>	<p>21</p>	<p>22</p>	<p>23</p>	<p>24</p>

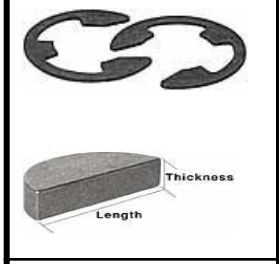
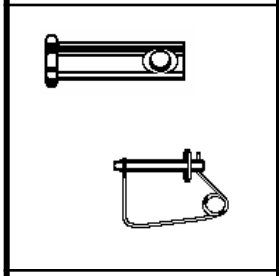
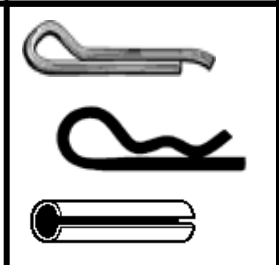

LET US HELP YOU MAKE THE CONNECTION

PART# 3091

ATO SMART GLOW FUSES



J & B FLEET-INDUSTRIAL SUPPLY
PHONE: 330-821-6342

57390 5 AMP TAN 5	57391 7-1/2 AMP BROWN 5	57392 10 AMP RED 5	57393 15 AMP BLUE 5	57394 20 AMP YELLOW 5	57395 25 AMP NATURAL 5
57396 30 AMP GREEN 5					

LET US HELP YOU MAKE THE CONNECTION

PART# 3092

SMART GLOW FUSES



J & B FLEET-INDUSTRIAL SUPPLY
PHONE: 330-821-6342

57390 5 AMP ATO TAN 3	57391 7-1/2 AMP ATO BROWN 3	57392 10 AMP ATO RED 3	57393 15 AMP ATO BLUE 3	57394 20 AMP ATO YELLOW 3	57395 25 AMP ATO NATURAL 3
57396 30 AMP ATO GREEN 3	57400 5 AMP MINI TAN 3	57401 7-1/2 AMP MINI BROWN 3	57402 10 AMP MINI RED 3	57403 15 AMP MINI BLUE 3	57404 20 AMP MINI YELLOW 3
57405 25 AMP MINI NATURAL 3	57406 30 AMP MINI GREEN 3				

LET US HELP YOU MAKE THE CONNECTION

Part# 3093

MINI SMART GLOW FUSE



J & B FLEET-INDUSTRIAL SUPPLY
PHONE: 330-821-6342

57400 5 AMP TAN 5	57401 7-1/2 AMP BROWN 5	57402 10 AMP RED 5	57403 15 AMP BLUE 5	57404 20 AMP YELLOW 5	57405 25 AMP NATURAL 5
57406 30 AMP GREEN 5					

LET US HELP YOU MAKE THE CONNECTION

PART # 3059



LOW PROFILE MINI FUSE



J & B FLEET-INDUSTRIAL SUPPLY
PHONE: 330-821-6342

20943 5 AMP TAN 5	20944 7-1/2 AMP BROWN 5	20945 10 AMP RED 5	20946 15 AMP BLUE 5	20947 20 AMP YELLOW 5	20948 25 AMP NATURAL 5
20949 30 AMP GREEN 5					

LET US HELP YOU MAKE THE CONNECTION

PART # 3050

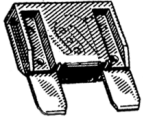

MAXI AUTOFUSES



J & B FLEET-INDUSTRIAL SUPPLY
PHONE: 330-821-6342

42176	42178	42180	42182	42184	42174
20 AMP	30 AMP	40 AMP	50 AMP	60 AMP	70 AMP
2	2	2	2	2	2
					42175
					80 AMP
					2

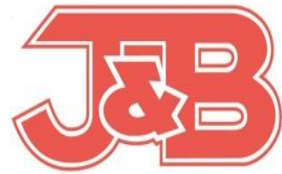













J&B Fleet - Industrial Supply

www.jbfleet.com

22428 Harrisburg-Westville Rd. Alliance, Ohio 44601 Phone: (330) 821-6342 Fax: (330) 821-0411

PART # 2821

J CASE FUSES

 86113 40 AMP LOW PROFILE GREEN 3	 86114 50 AMP LOW PROFILE RED 3	 86115 60 AMP LOW PROFILE YELLOW 3
 86110 20 AMP LOW PROFILE BLUE 3	 86111 25 AMP LOW PROFILE CLEAR 3	 86112 30 AMP LOW PROFILE PINK 3
 42707 40 AMP GREEN 3	 42708 50 AMP RED 3	 42709 60 AMP YELLOW 3
 42705 20 AMP BLUE 3	 42710 25 AMP WHITE 3	 42706 30 AMP PINK 3



LET US HELP YOU MAKE THE CONNECTION

PART# 3096



J CASE FUSES



J & B FLEET-INDUSTRIAL SUPPLY
PHONE: 330-821-6342

86110 LOW PROFILE 20 AMP BLUE 2	86111 LOW PROFILE 25 AMP CLEAR 2	86112 LOW PROFILE 30 AMP PINK 2	86113 LOW PROFILE 40 AMP GREEN 2	86114 LOW PROFILE 50 AMP RED 2	86115 LOW PROFILE 60 AMP YELLOW 2
42705 20 AMP BLUE 2	42710 25 AMP WHITE 2	42706 30 AMP PINK 2	42707 40 AMP GREEN 2	42708 50 AMP RED 2	42709 60 AMP YELLOW 2

LET US HELP YOU MAKE THE CONNECTION

PART# 3094

AUTO LINK PAL FUSES



J & B FLEET-INDUSTRIAL SUPPLY
PHONE: 330-821-6342

57420 20 AMP BLUE FEMALE 2	57421 30 AMP PINK FEMALE 2	57422 40 AMP GREEN FEMALE 2	57423 50 AMP RED FEMALE 2	57424 60 AMP YELLOW FEMALE 2	
57430 30 AMP PINK MINI FEMALE 2	57431 40 AMP GREEN MINI FEMALE 2				

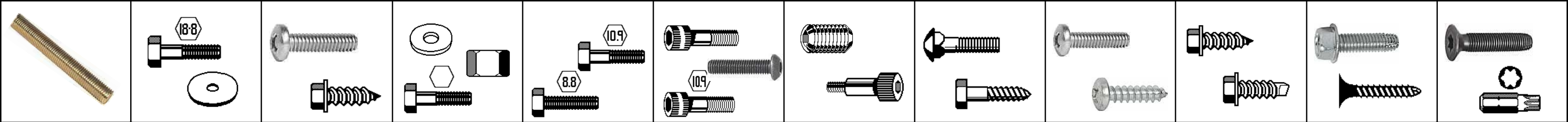

PART# 2820



J&B Fleet - Industrial Supply

22428 Harrisburg-Westville Rd. Alliance, Ohio 44601 Phone: (330) 821-6342 Fax: (330) 821-0411

www.jbfleet.com

MICRO FUSES

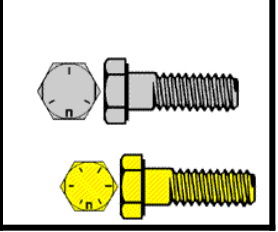
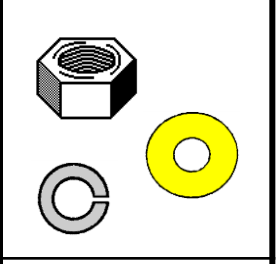
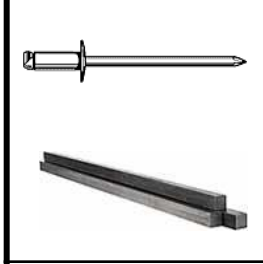
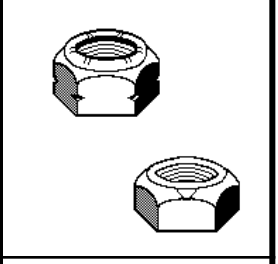
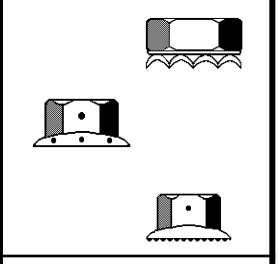
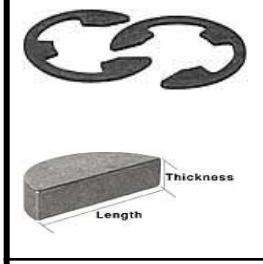
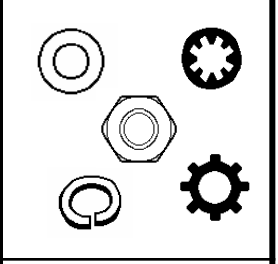
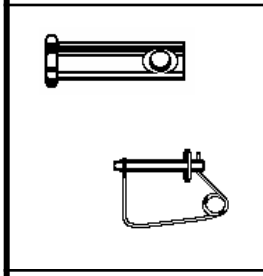
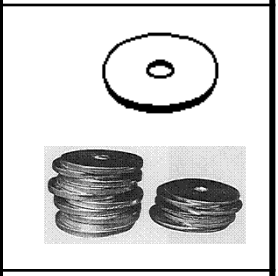
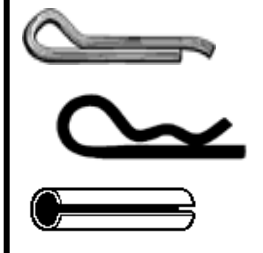

1	2	3	4	5	6
7	8	9	10	11	12
13	14	15	16	17	18
19	20	21	22	23	24

86091

**15 AMP
M CASE
TAN**

4

86092

**20 AMP
M CASE
BLUES**

4

86093

**25 AMP
M CASE
CLEAR**

4

86094

**30 AMP
M CASE
PINK**

4

86095

**40 AMP
M CASE
GREEN**

4

86103

**30 AMP
MICRO 2 FUSE
GREEN**

5

86105

**5 AMP
MICRO 3 FUSE
TAN**

5

86106

**7.5 AMP
MICRO 3 FUSE
BROWN**

5

86107

**10 AMP
MICRO 3 FUSE
RED**

5

86108

**15 AMP
MICRO 3 FUSE
BLUE**

5

86097

**5 AMP
MICRO 2 FUSE
TAN**

5

86098

**7.5 AMP
MICRO 2 FUSE
BROWN**

5

86099

**10 AMP
MICRO 2 FUSE
RED**

5

86100

**15 AMP
MICRO 2 FUSE
BLUE**

5

86101

**20 AMP
MICRO 2 FUSE
YELLOW**

5

86102

**25 AMP
MICRO 2 FUSE
CLEAR**

5



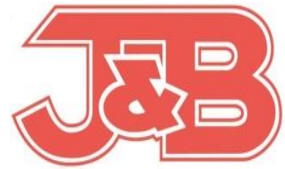















J&B Fleet - Industrial Supply

www.jbfleet.com

22428 Harrisburg-Westville Rd. Alliance, Ohio 44601 Phone: (330) 821-6342 Fax: (330) 821-0411

C-BREAKERS & SWITCHES

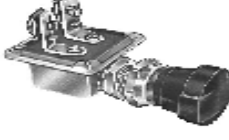
PART # 2108

<p>38980 ¹</p>  <p>10 AMP SNAP IN TYPE CIRCUIT BREAKER</p>	<p>38981 ²</p>  <p>15 AMP SNAP IN TYPE CIRCUIT BREAKER</p>	<p>38982 ³</p>  <p>20 AMP SNAP IN TYPE CIRCUIT BREAKER</p>	<p>38983 ⁴</p>  <p>30 AMP SNAP IN TYPE CIRCUIT BREAKER</p>	<p>38984 ⁵</p>  <p>40 AMP SNAP IN TYPE CIRCUIT BREAKER</p>	<p>39286 ⁶</p>  <p>TWO POSITION TOGGLE SWITCH</p>
<p>⁷</p>	<p>⁸</p>	<p>⁹</p>	<p>¹⁰</p>	<p>42380 ¹¹</p>  <p>TOGGLE SWITCH BOOT</p>	<p>39288 ¹²</p>  <p>THREE POSITION TOGGLE SWITCH</p>
<p>40960 ¹³</p>  <p>10 AMP BLADE TYPE CIRCUITBREAKER</p>	<p>40961 ¹⁴</p>  <p>15 AMP BLADE TYPE CIRCUITBREAKER</p>	<p>40962 ¹⁵</p>  <p>20 AMP BLADE TYPE CIRCUITBREAKER</p>	<p>40963 ¹⁶</p>  <p>25 AMP BLADE TYPE CIRCUITBREAKER</p>	<p>40964 ¹⁷</p>  <p>30 AMP BLADE TYPE CIRCUITBREAKER</p>	<p>39287 ¹⁸</p>  <p>UNIVERSAL PUSH PULL SWITCH</p>
<p>¹⁹</p>	<p>²⁰</p>	<p>²¹</p>	<p>²²</p>	<p>²³</p>	<p>39285 ²⁴</p>  <p>MOMENTARY PUSH BUTTON SWITCH</p>



LET US HELP YOU MAKE THE CONNECTION

PART# 3095



MICRO FUSES



J & B FLEET-INDUSTRIAL SUPPLY
PHONE: 330-821-6342

86097 MICRO 2 5 AMP TAN 5	86098 MICRO 2 7.5 AMP BROWN 5	86099 MICRO 2 10 AMP RED 5	86100 MICRO 2 15 AMP BLUE 5	86101 MICRO 2 20 AMP YELLOW 5	86102 MICRO 2 25 AMP CLEAR 5
86103 MICRO 2 30 AMP GREEN 5	86091 M CASE 15 AMP TAN	86092 M CASE 20 AMP BLUE 4	86093 M CASE 25 AMP CLEAR 4	86094 M CASE 30 AMP PINK 4	86095 M CASE 40 AMP GREEN 4
86105 MICRO 3 5 AMP TAN 5	86106 MICRO 3 7.5 AMP 5	86107 MICRO 3 10 AMP RED 5	86108 MICRO 3 15 AMP BLUE 5		

LET US HELP YOU MAKE THE CONNECTION



J & B FLEET-INDUSTRIAL SUPPLY
PHONE: 330-821-6342

VALVE CAPS

PART#3102

20458



**BLACK PLASTIC
CAP**

10

39009

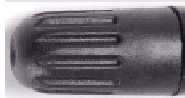

**LONG SKIRTED
BLK PLACSTIC
CAP WITH SEAL**

10

39014



**GRAY PLACSTIC
CAP WITH SEAL**

10

39016



**GREEN PLAC-
STIC CAP WITH
SEAL**

10

39017



**LONG METAL
DOME CAP WITH
SEAL**

10

20456



**HD METAL
DOME CAP WITH
SEAL**

10

39019

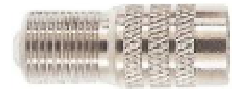

**DOUBLE SEAL
VALVE CAP**

5