

IP410 IP PHONE

User Manual



Tables of Contents

1.	About	3
2.	IP410 Overview:	3
3.	Features.....	3
4.	Technical Parameters	4
5.	Inside the box.....	5
6.	Connecting Your Phone.....	5
7.	Adjustable Stand	7
8.	Phone Buttons and Hardware.....	8
9.	IP410 Display.....	9
10.	Placing a Call	10
11.	Placing a Call (pre-dial).....	11
12.	Ending a Call:.....	11
13.	Using Last Number Redial:	12
14.	Last Number Redial One-Button Speakerphone	12
15.	Using Call Logs:.....	13
16.	Answering a call	14
17.	Answering a call while connected to a call	14
18.	Auto – Answer: Answering a call.....	15
19.	Using Hold and Auto Hold	16
20.	Transfer a Call.....	17
21.	Transfer Line-to-Line	18
22.	Using Mute.....	18
23.	Do Not Disturb (DND)	19
24.	Selective DND.....	19
25.	Conference – Three-Way	20
26.	Conference Rooms 901 & 902	21
27.	Parking a Call 700.....	21
28.	Phonebook Individual/Enterprise	22
29.	Transfer to Voice Mail	23
30.	Voice Mail	23
31.	Voice Mail – Access from outside	23
32.	Voice Mail – Access from a phone other than your extension	23
33.	Voice Mail Setup (The First Time You Log In)	24
34.	Voice Mail Menus	24
35.	Voice Mail – Listening to Messages	25
36.	Voice Mailbox – Greetings	27
37.	Voice Mailbox – Folders	27
38.	Pause Key	27
39.	Custom Ringing	28
40.	Volume Adjustments – Receivers/Speaker	29
41.	Volume Adjustment – Microphones	30
42.	Menu.....	31
43.	Buttons and Codes	33

1. About

The IP410 is an enterprise-grade communications device designed to provide the user access to all of the capabilities possible in Voice Over Internet and Voice Over LAN/WAN technologies. The IP410 is a HD® (High Definition) equipped, 4 – SIP-Line phone; SIP is the most advanced packet-switched data transport available for voice communications. Through the use of SIP-Gateways the IP410 is also capable of interfacing the legacy telephony network.

HD IPitomy's HD telephones use wideband speech CODECs which encode 7.1KHz of the voice spectrum instead of the standard 3.4KHz. This doubles the bandwidth for communications and elevates voice quality substantially. Combine HD audio with IPitomy's acoustically tuned housing, and the end result is industry-leading speakerphone clarity.

Your IP410 can utilize the g.722 codec and provide HD audio while taking up no more bandwidth than the standard g.711 codec. This means better sound and no sacrifice.

2. IP410 Overview:

- 4 dynamic, context-sensitive soft keys
- 4 SIP Line keys for use with up to four SIP extensions (SIP Accounts) or multiple appearances of the same extension (SIP Account)
- Up/Down/Right/Left and OK Navigation keys
- 8 programmable keys (speed-dial/feature keys)
- Segmented and fixed features access and call processing keys for ease of use
- 12-key standard telephone dial pad
- Big Red speaker button to answer and disconnect calls
- All Clear button for easy navigation back to original menu position
- Multi-position Stand
- Integrated Wall Mount
- Dual 10/100Mbps auto-sensing Ethernet ports with integrated PoE
- High Definition Audio
- Auto provisioning to IPitomy IP PBX
- Enterprise Phone Book
- Personal Phone Book

3. Features

- 240 X 160 graphic LCD
- 4 VoIP accounts
- HD Voice: HD Codec
- BLF
- Business Features – Park, Page, Group Page, Hands Free
- XML Phonebook
- Headset Mode with two alternatives for connectivity – RJ9 and 3.5mm Audio
- PoE, 2xRJ45
- Supports up to 6 Expansion Modules
- 8 Programmable keys
- Encryption

4. Technical Parameters

Item	IP410
Screen	4-level Gray scale LCD with back light 240 X 160 pixel
Language	English, Chinese
SIP Lines	4
Function Keys	4 Soft keys, 4 Line keys (dual-color LED) 6 Navigation keys (arrow button, OK button, Clear button) 12-key telephone Dial Pad Volume adjust bar +/-, Speakerphone (Red button), Mute, Headset, Message, Menu, Directories, Service, Hold, Redial, Conference, Transfer
VoIP Protocol	SIP 2.0
Network	2 - RJ45 10/100M Ethernet interfaces (LAN/PC) IP Assignment: Static IP or DHCP DNS Client
Network Protocol	TCP/IP, HTTP, BOOTP, TFTP, *IEEE 802.1Q, *IEEE 802.1X
Codec	G.723.1, G.729 A, G.711 A/U, G.722
QoS	TOS, Jitter Buffer, VAD, CNG, G.168 (32ms)
Call Processing	Call Sharing/Bridged Lines Line Status Indicator (dual color LED) Multiple Accounts possible Call Waiting, Call Queuing, Line Switching Call Forward, Call Transfer, Call Holding, Call Pickup, Call Park, Page Callback One Key Dial, Redial Phone directory speed dial, Call record direct dial 3-way conference (Phone capacity) Do Not Disturb Voice mail, Voice Prompt, Voice Message BLF (Busy Lamp Field)
Expansion Interface	The port "EXT" on the bottom of the phone is used to interface the IPX32 expansion module. This expansion module adds 32 keys per module. Six total modules can be used with the IP410. An external power adapter is required when 4 or more expansion modules are installed.
USB	Future Use
Security	User Authentication for configuration pages Signaling encryption Media encryption
Application	Public phone directory Private phone directory Auto Discovery / Auto Provision
Power Supply	Power adapter: AC 100-240V input and DC 12V/1A output (not included) PoE (IEEE 802.af)
POE WATTS	Power consumption of the IP410 is 5 WATTS... add 2 WATTS for each Expansion Module attached. When using more than 3 Expansion Modules use an external power supply (Model: PS346).
Environment	Storage Temperature: 0° - 60° C Operating Humidity: 10% - 90% Size 254mm*205mm*87mm

5. Inside the box

If you are removing the IP410 from its carton, you can check the contents against the following list to assure that all parts have been received:

Item	Quantity
HD-compliant IP Speakerphone	1
HD-compliant Handset	1
1.5-meter Handset Cord	1
3-meter RJ45 cable	1
Wall Mount Template	1
Button label Sheet (8 labels)	1

6. Connecting Your Phone

Your system administrator will likely connect your new IPitomy IP410 IP Phone to the corporate IP telephony network. If not, use the steps and figures to connect your phone and setup your telephone.

- 1) Connect the Handset Cord into RJ9 (4) connector on the underside of the telephone.
 - a) Inspect the handset cord and notice that one end has an extended portion that is flat (not coiled). This is the end of the cord is to be placed into the molded plastic channel leading from the connector to the edge of the telephone.
- 2) Connect the LAN connector to the telephone to the Telephony enabled network.
 - a) When your network is PoE (Power Over Ethernet) equipped it will not be necessary to use a power supply with your telephone. If not, you will need the optional power supply (PN: PS346) to use your phone.
- 3) You may also connect a PC to the "PC" connector to facilitate that PC's network connection.
- 4) The optional IXP32 (Expansion Module) "IN" connector is connected to the "EXT" of the telephone.

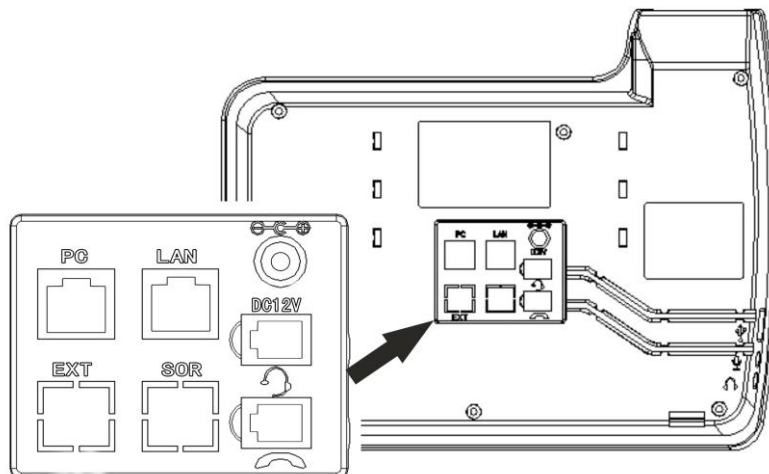

Figure 1 Connections on the back of IPitomy IP410

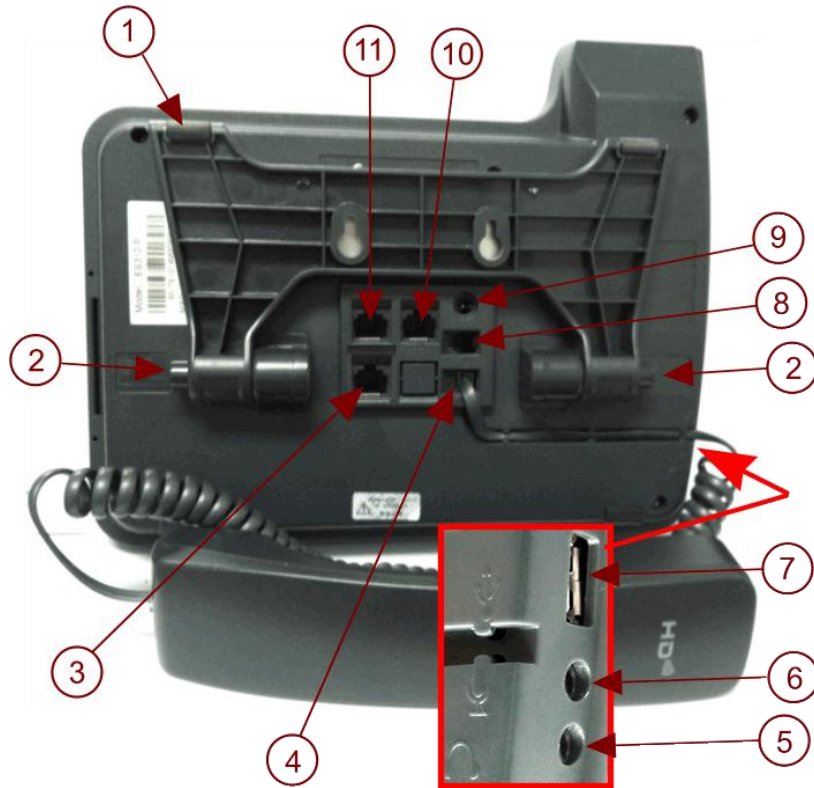

Figure 2 Photo of connections and definitions

	Hardware	Functions
①	Adjustable Stand (integrated Wall Mount)	The telephone viewing angle may be adjusted to suit your preference. Press in button (2) and adjust as you wish. In the position shown (all the way up) the telephone can be wall mounted.
②	Stand Adjustment Button	Press buttons at the same time to adjust the angle
③	Expansion connector	EXT: IXP32 interface; Use to Plug in expansion module SOR: (adjacent to "EXT") Unused
④	Handset connector	Connect the Handset
⑤	Headphone port	Connect the Headphone
⑥	Microphone port	Connect the Microphone
⑦	USB port	Reserved for future functionality
⑧	Headset port	RJ9 – Type Headset connection
⑨	Power connector	Used with optional Power Supply (PN: PS346) 12VDC
⑩	LAN connector	Connect to Telephony-enabled LAN (PoE preferred)
⑪	PC port	Connect to a local PC (if desired)

7. Adjustable Stand

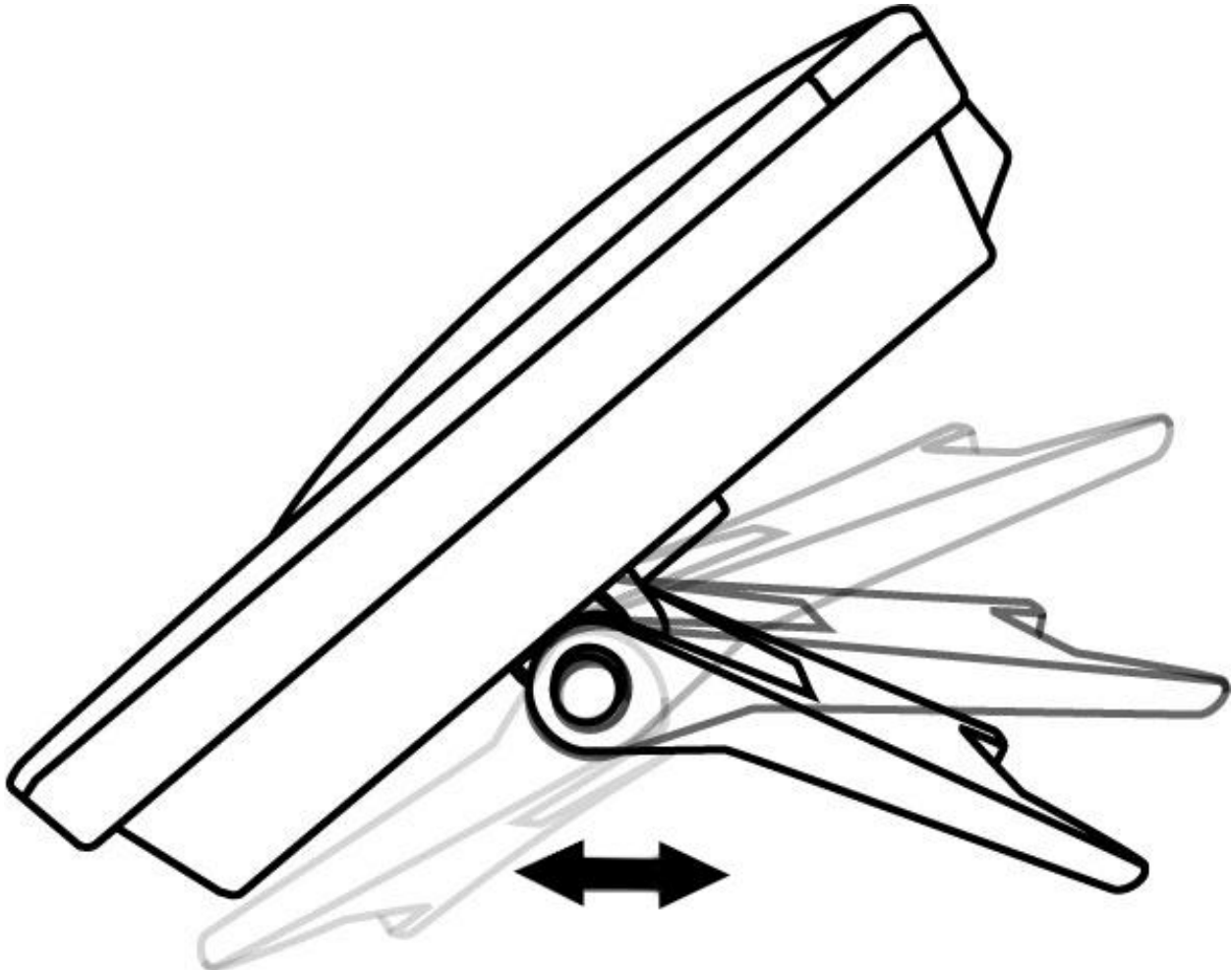

Figure 3 Adjustable Stand

Your IP410 telephone is equipped with an integrated universal adjustable positioning stand. This feature allows you to position the telephone as you wish for your own optimum viewing angle. The design of the stand also allows the telephone to be wall mounted if desired – no additional parts are required.

For wall mounting, use the included wall mount template to position screws (not included) on the wall surface. (Care should be taken to secure the mounting screws adequately with consideration of the wall material.)

8. Phone Buttons and Hardware

1		Headset: Toggles the headset on or off (Red) active
2		Service: Future Use – no uses at this time
3		Mute: Toggles the Mute feature on/off (Red) when MUTE active
4		Directories: Use to access Call History and Phone Books.
5		Messages: Use to access voice mail Red = unheard voice messages waiting
6		Menu: Used to set features and access programming.
7		240 X 160 Graphic LCD: • SIP Line activity display • Soft-Key operations • Display all various data
8		Line buttons Line Status Lamps Select line (Call/Answer)
		Red, flashing: ringing call Red, steady: in use, on call
		Green, flashing: Holding call Green, steady: Active call
9	Light Bar	Indicates In-Use status
10		Soft Keys: activate displayed function using associated button (key) below
11		Programmable Buttons: quick access to frequently used functions and user status (BLF) display and calling
12		Microphone (for hands-free operations)
13		Clear: used similarly to abort displayed menu prompts and return to previous/Home
14		Navigation and Select "OK" buttons for use in menu operations and call processing
15		



Figure 4 IPitomy IP410 Buttons and Hardware Definitions

16		Speakerphone: answer and place calls using the hands-free speakerphone
17		Dial Pad: Basic Call Placement, AND: Press to send a dialed number
18	Speaker	The speaker used in all hands-free operations
19		Hold: Place calls on hold
20		Transfer: Transfer a connected call to someone else
21		Volume rocker: Controls the volume for all various modes Volume settings are retained for each function: • Handset • Headset • Hands-free • Speakerphone • Ringer
22		Conference: Build phone-based conference calls (3-parties max.)
23		Redial: Redials the last number

9. IP410 Display

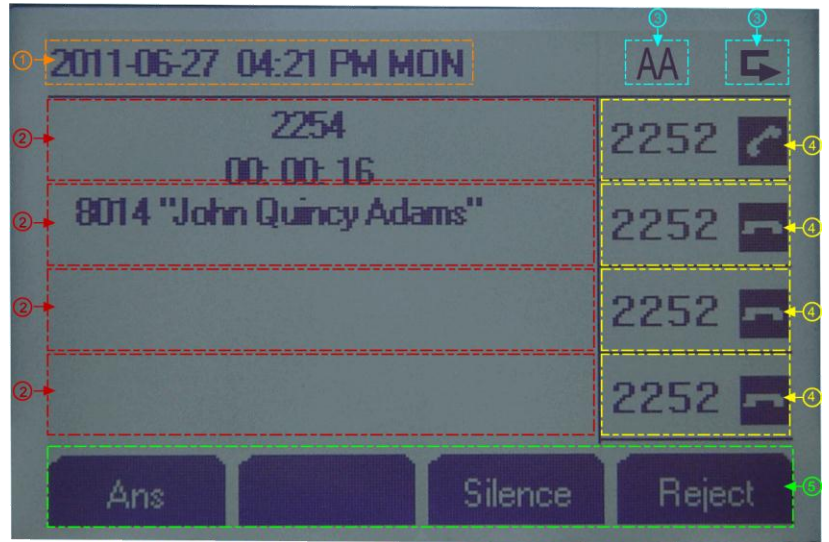







1	Time and Date	Current time and date is displayed
2	Line Activity	<p>The Line Call Activity is divided into quadrants which displays</p> <ul style="list-style-type: none"> Number Dialed (for outbound calls) Caller ID Number and Name (for inbound calls) Time Duration of call on the line Missed Calls per line (not shown)
3	Features Status	<p>For the three user-invoked features a status is displayed:</p> <p>AA Auto-Answer feature is active</p> <p> VoIP Call Forward Active (Telephone-based CFWD)</p>

4	SIP Line	SIP Line and status are shown here. The display is programmed to show the extension or line that is accessed by the associated button. In this case, PBX extension 2252. ICONs are also shown indicating the status of the line.	
			Line NOT registered
			Line Registered and Idle or Ring
			Line In Use
			Line on Hold
			Line in Do Not Disturb
			Line in Transfer state
			Conference – Three-way
5	Soft Keys	Displayed content here is dynamic to the call status. Soft Keys enhance the use of features.	

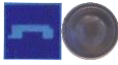
10.Placing a Call

There are three ways to use your phone for calls:

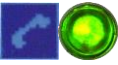
1. Using the handset
2. Using the Speakerphone
 - a. Use of the speakerphone is convenient and desirable for many calls, however the environment in which the phone is located must be taken into consideration when using the speakerphone. Acoustic properties and ambient noise will impact the performance of your speakerphone.
3. Using a Headset
 - a. Using a headset requires that an ancillary headset device be connected to either the RJ9 connector on the back of the phone or to the 3.5mm Microphone and Speaker connectors on the side of the phone.

Steps:	1	2	3	
Handset Call	Lift Handset			
Speakerphone Call	Press  Speaker Button, OR:  Idle Line Button OR:  Soft Key	Dial Number 	Press  OR 	Your call will be connected  Line Lamp Steady Green
Headset Call	 Headset Button			

Notes:

- 1) The IPitomy PBX will auto place your call based on the number dialed.
 - a) Extension calls and network numbers are dialed in the same manner
- 2) When calling an IPitomy telephone extension it is possible to place the call with hands-free reply. To do this

preface the extension number with  .







11.Placing a Call (pre-dial)

Steps:	1	2	3	
Handset Call			Lift Handset	
Speakerphone Call	<p>Dial Number</p>	<p>Press:</p> <p>to make corrections in number</p> <p>OR:</p> <p>to abort</p>	<p>Press</p> <p>Speaker Button, OR:</p> <p>Idle Line Button OR:</p> <p>Soft Key</p>	<p>Your call will be connected</p> <p>Line Lamp Steady Green</p>
Headset Call			<p>Headset Button</p>	





12.Ending a Call:

Steps:	1
Handset Call	<p>Hang Up</p> <p>Press</p> <p>Speaker Button</p> <p>OR</p> <p>Soft Key</p>
Speakerphone Call	<p>OR</p> <p>Soft Key</p>
Headset Call	<p>Headset Button</p> <p>OR</p> <p>Soft Key</p>

13. Using Last Number Redial:

Steps:	1	2
Handset Call	Lift Handset	
Speakerphone Call	Press  Speaker Button, <i>OR</i> :   Idle Line Button <i>OR</i> :  Soft Key	Press  REDIAL
Headset Call	 Headset Button	

14. Last Number Redial One-Button Speakerphone

Steps:	1
	Press  REDIAL <i>OR</i>  ReDial Your call will be connected   Line Lamp Steady Green







15. Using Call Logs:

Your IPitomy IP410 telephone will store 100 numbers each for the following Call Logs:

- Missed Calls
- Received Calls
- Dialed Numbers

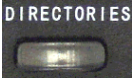
These numbers can be stored on your personal Phone Book or dialed directly from the list.







Follow these steps to retrieve a number from those saved on your telephone.

Steps:	1		2	3	4	5	6
Dialed Numbers	Press 	Right Navigation Key	Use the Up and Down Navigation Keys to find the number you want.	Press Dial OR:  to view call data	From View press Save To store in your Phone Book		
Phone Book & Call History		Directories Button	Use the Up and Down Navigation Keys to select "Call History"	Use the Up and Down Navigation Keys to select the Call Log desired	Use the Up and Down Navigation Keys to find the number you want.	Dial OR  to view call data	From "View" press Save To store in your Phone Book
Menu Access to Call Logs	 OR 	Navigation "OK" Key	Use the Up and Down Navigation Keys to select "Call History"	Use the Up and Down Navigation Keys to select the Call Log desired	Use the Up and Down Navigation Keys to find the number you want.	Dial OR  to view call data	From View press Save To store in your Phone Book

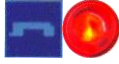
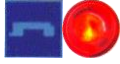
Note: Use soft-keys **Del** or **DelAll** to delete one entry or all entries in a call log.

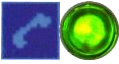

16. Answering a call

You can answer a call by simply lifting the handset. To answer using one of the other call options:

Steps:		1	2	To End Call
Answer Using Handset		Lift Handset		Hang Up
Answer Using Speakerphone	Line Ringing  Line Button flashing Red	Press  Line Button, OR:  Soft Key, OR:  Speaker Button	You will be connected to the ringing call 	Press  OR: 
Answer Using Headset		Press  Headset Button		Press 



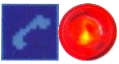
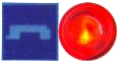
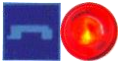
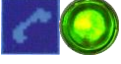



17. Answering a call while connected to a call

Answering a new call while connected on a call is enhanced with Auto Hold (see Using Hold and Auto Hold). The streamlined steps to making this function are:



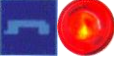
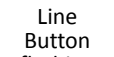
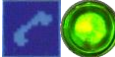





Steps:	1	2	note
Line connected  Line Button lit steady Red Line Ringing  Line Button flashing Red	Press Ringing (flashing)  Line Button	You will be connected to the ringing call.  Steady Green	The previous call is automatically placed on hold  Flashing Green

18.Auto – Answer: Answering a call

Auto Answer simplifies answering calls by connecting them automatically. When this mode is active all calls to the extension will be answered automatically in the respective modes.

	Idle Status	Auto Answer	To End Call
Answer Using Handset	Handset off-hook		Press 
Answer Using Speakerphone	 Speaker Button idle	Line Ringing  Line Button flashing Red 	You will be connected to the ringing call.  Steady Green
Answer Using Headset	 Headset Button		Press  OR 

Activate Auto Answer

- 1) At Idle phone press 
- 2) Use the Navigation keys and scroll to “Function settings” and press  or .
- 3) Use the Navigation keys and scroll to “Auto answer” and press  or .
- 4) Use the Navigation keys and scroll to “Enable” and press  or .
- 5) Press  to exit the menu. Auto Answer is now active.





19. Using Hold and Auto Hold

Hold



You can hold calls and then retrieve them when you're able.

Auto Hold

Your IP410 will automatically hold calls for you. While already on one line – press another (ringing or idle); the first call is held and the next line is accessed.

		Steps:	
		1	
Hold		Press  OR 	Call is placed on hold   Flashing Green
Auto Hold	  On a call	Press   Idle Line AND   Ringing Line	The first call is placed on hold   Flashing Green AND Connected to the ringing call.   Answer Line lit steady Green

Notes:













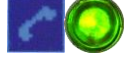

- 1) To retrieve a call from Hold, press the desired holding line button (flashing yellow/ green)  .
- 2) Callers on hold usually hear music or a periodic tone to indicate their held status.

20. Transfer a Call

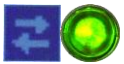
Call Transfer is used to direct a call from your telephone to the exact destination you wish. In the steps below the “target” is the number to which you want the call to be delivered.

There are two techniques you can use to transfer calls:

- Blind – used to deliver the call to the target expeditiously
- Announced – announce the call transfer to the target before completing the transfer

	Steps:	1	2	3	4
Blind Transfer		Press  OR: 	Press 	Input  Extension No.	Press  OR  The call is moved from your telephone to the target
Announced Transfer	 On a call	 OR: 	The active line ICON will indicate the transfer 	Press  OR  Wait for the target to answer and then announce the transfer	To complete the transfer press  OR:  To cancel the transfer and retrieve the call, press 



Notes:

- 1) Blind Transfer will convey the Caller ID of the call being transferred.
- 2) Announced Call Transfer will convey the Caller ID of your extension since that was the call connected prior to the transfer taking place.
- 3) You can transfer a caller to an extension’s voice mailbox to leave a message by inserting a  before the extension number (see Transfer to Voice Mail.)

21. Transfer Line-to-Line

Sometimes it's desirable to transfer a call to a line that you have previously placed on hold. The IP410 makes this possible with Transfer Line-to-Line.

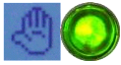
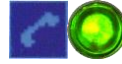

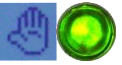
In this operation, one caller is on hold and the other is on the active line (connected to you). To connect these two people together simply transfer the connected call to the held call. As follows:

		Steps:		1	2	
Transfer Line-to-Line	 Line on Hold	 Connected Call (different line)		Press  OR 	Press  Line on Hold	The call to which you were connected is now connected to the call that had been on hold. (Your phone returns to idle)

22. Using Mute

When Mute is active, you can hear other parties on a call but they cannot hear you. You can use mute in any of the modes:

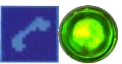
- Handset
- Speakerphone
- Headset

		Steps:	
Announced Transfer	 On a call (any line)		1 Press   Red indicates Mute is active

Notes:

- 1) Mute May be activated prior to connection.
 - a) Press Mute then lift handset
 - b) Press Mute then press Speaker Button
 - c) Press Mute then press Headset Button
- 2) Mute may be activated and deactivated during a conversation
- 3) When a connection is ended, Mute will automatically deactivate

23. Do Not Disturb (DND)

You can use Do Not Disturb (DND) to block incoming calls to your phone.



Notes:

- Callers will hear busy tone when they call the extension in DND
- You can still make calls on a line that is in DND.
- To cancel DND just press  again

24. Selective DND



Since up to four SIP Accounts may be registered on your phone you may wish to activate DND on one or more specific SIP Lines. The IP410 accommodates this nicely with Selective DND.

In the photo notice:

- two lines are extension 2252, and
- two lines are extension 5555
- Notice too that extension 5555 is in DND

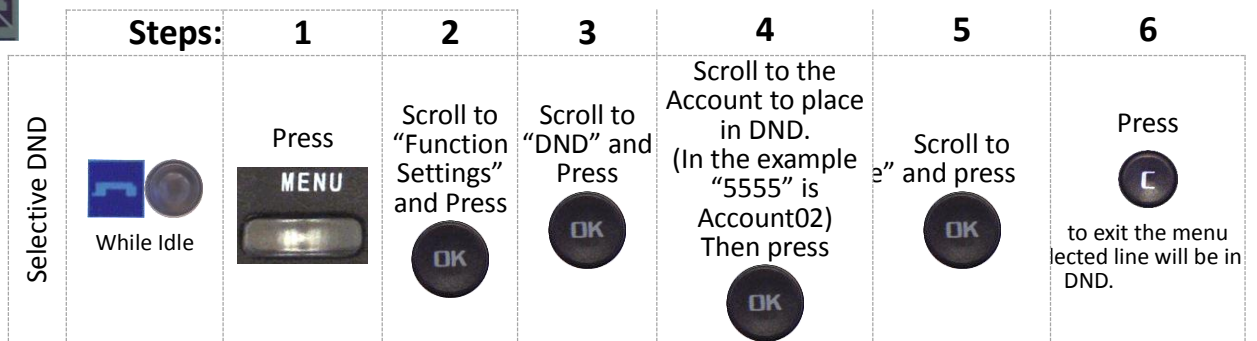













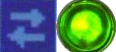

Notes:

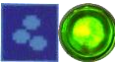
- 1) To cancel Selective DND repeat the process and select "Disable".
- 2) To cancel all DND, press  twice.

25. Conference – Three-Way

Conference calling allows you to merge two other people onto a connection on your telephone. (3-way conference = you and two others.) When using an IPitomy IP PBX, conference capacities are greatly increased through the use of Conference Rooms. Conference – Three-Way is a telephone centric feature.

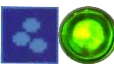
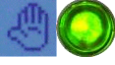
Perform the following steps to establish a three-way conference call on your telephone:

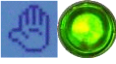
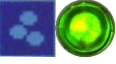



	Steps:	1	2	3	4	5	6
Conference from transfer	 On a call (any line)	Press  OR: 	The active line ICON will indicate the transfer 	Input  Extension No.	Press  OR  Wait for the target to answer and then announce the transfer	If you decide to conference rather than transfer just Press 	The conference is established  The Conference ICON is shown
Conference from idle	 Idle Line	Place your first call using Placing a Call	Press  OR: 	Place your second call using Placing a Call	Press  OR: 	The conference is established  The Conference ICON is shown	
Conference from Hold	 Line on Hold	Place a Call That which will be merge to holding line	Press  OR: 	Press  Holding line	The conference is established  The Conference ICON is shown		

Notes:

- 1) Conference – Three-Way is a telephone function and does not impact the Conference Rooms of the IPitomy IP PBX.
- 2) You may exit a Three-way Conference at any time – doing so will leave the other two parties connected in their own private conversation.
- 3) A Three-way Conference call cannot be transferred.
- 4) A Three-way Conference can be placed on hold.
 - a) While on-hold the holding parties are not connected to one another.

26. Conference Rooms 901 & 902

Conference Rooms are an IPitomy IP PBX feature and allow up to 32 parties to be connected. All IPitomy IP PBX's are equipped with two Conference Rooms minimum (Room 901 and Room 902). Additional Conference Rooms are available as an option. Use of Conference Rooms is quite easy and streamlines grouping any number of people up to 32 maximum in any one conference.

		Steps:		1	2
From Idle	 While Idle	Use Placing a Call operation and place a call to any Conference Room	 Conference Room No.	You are connected to that Conference Room	
Transfer to Conference Room	 On a call (any line)	Use Transferring Call operation and transfer this call to any Conference Room	 Conference Room No.	The call being transferred is connected to that Conference Room	

Note:

- 1) Callers may enter Conference Rooms from a Menu (Auto-Attendant)
- 2) A Conference Room PIN (password) may be required.

27. Parking a Call 700

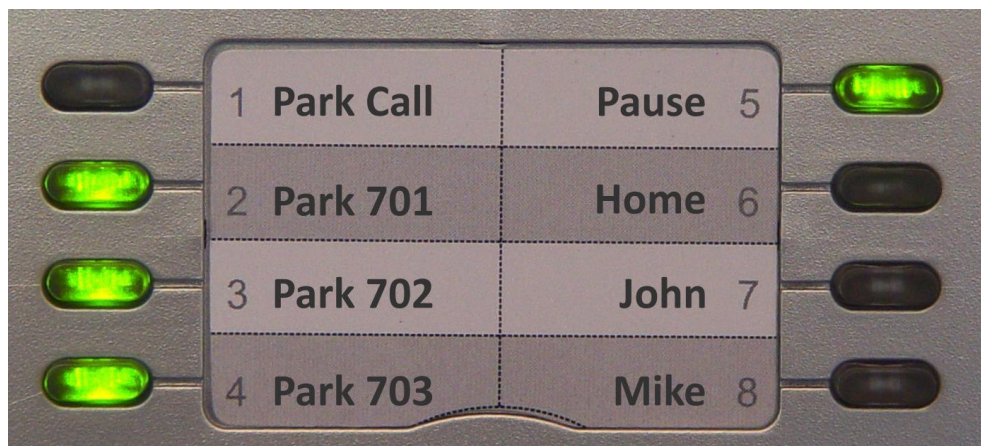

The IPitomy IP PBX is equipped with twenty (20) Park locations. Park locations are available for unique situations when a call cannot be transferred to a specific extension. Park locations are accessible by any PBX user and therefore are a general call delivery option.

Unless changed by specific application programming, the first four Programmable Buttons of your IP410 are preconfigured to operate with an elevated functionality with the first three Park locations. Button 1 is designated Park Call. Button 2, 3 and 4 are designated Park locations 701, 702, and 703.

Using Call Park is as simple as pressing the Park Call Button. When you do this the IPitomy IP PBX will position the call on the next available Park location (that is, if 701 is already in use, 702 will be selected.) **The IPitomy IP PBX will verbally advise you of the park location where the call has been positioned.**

You may then make a group page announcement and advise the recipient of the park location where their caller is waiting.

	Steps:	1	2	3	4	5
Park a Call using Park Call button	 On a call (any line)	Press Button adjacent to Park Call	Listen for the IPitomy IP PBX to announce the Park location	 The button adjacent to the Park location will light steady red		
Park a Call using Call Transfer	 On a call (any line)	Press OR: 	The active line ICON will indicate the transfer 	Input Park Call code	Press OR 	Listen for the IPitomy IP PBX to announce the Park location

Notes:

- 1) Idle Park location buttons may be green if programmed for green on idle operation.
- 2) Users may dial the park location to retrieve a call from that call park or press a button programmed for that call park.
- 3) Calls that are retrieved from call park locations are moved from that call park location to the extension line. Hence the call park location is available for another call.

28. Phonebook Individual/Enterprise

Phonebook keeps a list of contacts available for dialing. Two Phonebooks are available:







- Individual, and
- Enterprise

Phonebook entries can be assigned to groups for easy lookup. Each contact allows for three numbers.

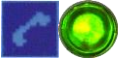
29. Transfer to Voice Mail

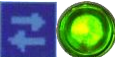
At times you may wish to connect a caller to a mailbox to leave a message for a user that is known to be unavailable. This is easily accomplished using the Transfer to Voice Mail function. To accomplish this operation you perform a

transfer as usual but preface the extension number with a . This will cause the transfer to go directly to that extension user's voice mail box greeting and allow them to leave a message.

Steps:	1	2	3	4	5
 On a call	Press  OR: 	The active line ICON will indicate the transfer 	Input   Extension No.	Press  OR 	The call is moved from your telephone to the voice mail box greeting to leave a message.

30. Voice Mail





Press the Voice Mail key on your telephone. This will bring you to a voice menu that will ask you to enter your password. Enter your password and follow the prompts to listen to messages.

31. Voice Mail – Access from outside

When you wish to access your voice mailbox while not in the office, you can do so from the automated attendant.

- 1) Dial into the automated attendant. (Usually this is the main number or another number that has been designated for outside voice mail access.)
- 2) Dial the designated digit (assigned during installation of the IP PBX).
- 3) You will be prompted to enter your mailbox number, then your password.
- 4) Follow the prompts to listen to messages.

32. Voice Mail – Access from a phone other than your extension

- 1) From a phone inside the office, dial    .
- 2) You will be prompted to enter your mailbox number, then your password.
- 3) Follow the prompts to listen to messages.

33. Voice Mail Setup (The First Time You Log In)

The first time that you log into your mailbox you should always change some settings. In particular, you should:







- Record your name
- Record your busy greeting
- Record your unavailable greeting
- Change your password

34. Voice Mail Menus



In voice mail there are many options for handling messages and how you are able to interact with the system to retrieve and administer your messages. Once you have entered into your mailbox you have the following menu options available:

Main Menu

The main menu will be the first menu that you are presented with once you have logged in.

-  Listen to messages in the currently selected folder
-  Change folders. See Section Changing Folders for more information
-  Advanced options
-  Mailbox options (see page 25)
-  Repeat the menu options
-  Exit from the voice mail system

Advanced Options

-  Place an outgoing call
-  Leave a message for another user on the system
-  Return to the main menu

0 Mailbox Options

1 Record your unavailable message

2
ABC Record your busy message

3
DEF Record your name

4
GHI Record your temporary greeting

If there is not a temporary greeting recorded, you will immediately be prompted to record a temporary greeting. If you do have a temporary greeting recorded you will be presented with the following menu:

1 Record a temporary greeting. This will allow you to record a new temporary greeting.

2
ABC Erase temporary greeting.

***** Return to the main menu

Once your temporary greeting has been erased, callers will be presented with either your busy or unavailable messages, depending on your status.

0 Change your password

***** Return to the main menu

35.Voice Mail – Listening to Messages

The Message Envelope

The voice mail system will play back the message “Envelope”. The “Envelope” is information about the message:

- Message Number
- Date and time that the message was received
- Caller ID information
- Duration of the message

Pressing **1** while listening to the message Envelope will skip the Envelope and playback the voice message.

During Message Playback

During the playback of the message(s), any of the following buttons may be pressed:

***** Rewind the message by 3 seconds

#
SEND Fast forward the message by 3 seconds

0 Pause the message playback. Press any other button to resume

After Message Playback

After the message has been played back, the system will play a prompt and wait for you to press a button:

- 1** Go to the first message in the current folder
- 2** Change folders
 - 0** New messages
 - 1** Old messages
 - 2** Work messages
 - 3** Family messages
 - 4** Friends messages
 - 5** Folder 1 messages
 - 6** Folder 2 messages
 - 7** Folder 3 messages
 - 8** Folder 4 messages
 - 9** Folder 5 messages
 - #** Cancel the change folder operation
- 3** Advanced options
 - 1** Record a message and send it directly to the mailbox of the person who sent you the current message
 - 2** Call the person that left the message back
 - 3** Play the message envelope
 - 4** Place an outgoing call *May not be allowed
 - 5** Leave a message for another user on the system
 - *** Return to the main menu
- 4** Go to the previous message in the folder
- 5** Replay the current message
- 6** Go to the next message in the folder
- 7** Delete or undelete the message
- 8** Forward the message to another user on the system
- 9** Save the message to a different folder
- 0** Mailbox options
- *** Replay the prompt
- #** Exit the voice mail system

36.Voice Mailbox – Greetings

A mailbox greeting is a message for you to inform the caller that you are away from your desk or busy on another call. There are three types of Greetings:

- **Not Available Greeting – Played when your phone is un-answered:**
“Hello, this is Mark; I am not able to answer your call right now. Please leave a detailed message and a number where I can reach you, and I’ll call you back as soon as I am able.”
- **Busy Greeting – Played when your extension is busy**
“Hello, this is Mark, I am currently on the phone and not able to take your call right now; please leave a detailed message and I will call you back as soon as I can.”
- **Temporary Greeting – if there is a Temporary Greeting recorded it is the greeting that callers hear.**
The temporary greeting is played as an override for your other greetings. When the situation warrants a greeting to inform your callers of something different than your regular greetings; record a temporary greeting and it will replace the others while it is active. Be sure to go back and delete your temporary greeting to return to the normal greeting. “Hello this is Mark; I am on vacation with limited access to messages. Please call extension 1500 and speak to Mary with any matters that need immediate attention. I will return on Monday, February 24.”

Default Greetings - If you do not record any greetings, IPitomy will play a set of default greetings depending on the status of your extension. Be sure to record your name so your greeting will be a little more professional sounding. If you do not record your name, the default greeting will say “the person at extension (your extension number) is not available”. If you record your name the greeting will say “Mark Smith” is not available...”

37.Voice Mailbox – Folders

The IPitomy IP PBX allows you to save and organize your messages into folders.

There are ten folders. The first 5 folders have convenient names for organizing messages:

- New
- Old
- Work
- Family
- Friends
- Folder 1
- Folder 2
- Folder 3
- Folder 4
- Folder 5











38.Pause Key

The IPitomy Pause Key is pre-programmed on your telephone (its button number 5). Pause is similar to DND but has a broader reach. Pause will instruct the IP PBX that you are unavailable to take calls. This is different than just placing your telephone in DND because DND is local to the phone and does not provide a status for call processing operations at the PBX. When Pause is active your status is rendered as busy at any device that indicates your status. Pause also makes your extension unavailable in Groups and ACD Call Queues.

39. Custom Ringing

You can select a ringing tone from a list of eight pre-programmed tones or upload a sound file to the telephone to make your telephone more distinctive among others when it is ringing.

To select your ring tone:

- 1) While busy or idle, press 
- 2) Use the Navigation keys and scroll to “System settings” and press  or .
- 3) Use the Navigation keys and scroll to “Phone settings” and press  or .
- 4) Use the Navigation keys and scroll to “Ring Type” and press  or .
- 5) All of the available ring tones will be listed here. Use the Navigation keys and select a tone/file from the list.
- 6) You can press  to listen to the tone before committing.
- 7) Press  or  to select this tone/file.

Notes:



- 1) Uploading a sound file is not covered in this document.
- 2) Sounds files that are uploaded to your telephone will be listed with the other ring tones.

40. Volume Adjustments – Receivers/Speaker















Your IP410 telephone has the ability to adjust volume settings in both directions for the call types:

- Handset
- Speakerphone
- Headset

This will allow you to fine-tune your telephone for the best possible audio connection in each of the various modes.

	Status	Adjust Listening Volume
Handset	Handset off-hook	 <p>Press the Volume Bar Up/Down to adjust the volume level for the mode in operation</p>
Speakerphone	 Speaker Button	
Headset	 Headset Button	
Ring	Telephone Idle	

41. Volume Adjustment – Microphones

- 3) While busy or idle, press 
- 4) Use the Navigation keys and scroll to “System settings” and press  or .
- 5) Use the Navigation keys and scroll to “Phone settings” and press  or .
- 6) Use the Navigation keys and scroll to “Volume settings” and press  or .
- 7) Use the Navigation keys and scroll to the desired device to adjust and press  or .
- Ring volume (same as that adjusted using Volume Bar while phone is idle.)
 - Handset volume (Same as that adjusted using Volume Bar while using Handset.)
 - **Handset mic volume** – use to adjust the microphone level of the handset
 - Speaker volume (Same as that adjusted using Volume Bar while using Speakerphone.)
 - **Speaker mic volume** – use to adjust the microphone level of the Speakerphone
 - Headset volume (Same as that adjusted using Volume Bar while using Headset.)
 - **Headset mic volume** – use to adjust the microphone level of the headset
- 8) Press  or .
- 9) Use the Navigation keys and scroll to the desired Volume Level and press  or .
- 10) The new setting is saved for this device. Press  to exit the menu.

42. Menu





















Your IP410 has many settings available via its MENU function. They are listed below.

Language	English only is available at this time
English	
Function Settings	Features and resources on the phone
Programmable Key	
Programmable Keys 1 – 8	
Mode	
Asterisk BLF	BLF = Busy Lamp Field Shows the status of the monitored extension and can be used to call/transfer that extension. May also be used to pick up calls that are ringing at that extension.
Speed Dial	Programmed with a number to dial when pressed
Speed Dial Prefix	Programmed with a number to insert prior to subsequent actions
BLA	not used at this time
DTMF	Used to send DTMF tones per telephony interface needs
Account SIP Account 1 – 4	Allows assignment of the button action to one or any of the installed SIP Accounts.
Name	Label for this button (reference and printout purposes)
Number	The actual value (content) of the button
DND	Do Not Disturb – Phone based
Account01 – 06 Enable/Disable	Enable/Disable per account
Message code	Used to assign the code that is associated to the VM button
Auto Answer	Enable/Disable
Expansion Installation	
Press 1 – 6 to install	When the IPX32 consoles are installed, they must be identified in software for allocation
Expansion Settings	
Expansion 1 – 6	
Programmable keys 1 – 32	
Mode	
Asterisk BLF	Same as Programmable Keys definition
Speed Dial	Same as Programmable Keys definition
Speed Dial Prefix	Same as Programmable Keys definition
BLA	Same as Programmable Keys definition
DTMF	Same as Programmable Keys definition
Account SIP Account 1 – 4	Same as Programmable Keys definition
Name	Same as Programmable Keys definition
Number	Same as Programmable Keys definition
Hot Line	Number to dial when this phone goes off-hook
Hot Line	Enable/Disable + Number (immediate)
Warn Line	Enable/Disable + Number (Hot Line after 3s pause)
Time & Date	Time and Date settings – usually serviced by PBX
Sntp	
SIP Server	
Manual Setting	

VOIP Call Forward	Telephone Call Forwarding (Independent of PBX CFWD)
All Calls	
Unconditional Transfer	Enable/Disable
Number	
If Busy	
Busy Transfer	Enable/Disable
Number	
If No Answer	
No Answer Transfer	Enable/Disable
Number	
Fuzzy Search	Can be used to “look-up” contacts while dialing numbers
Call History	
Missed Calls	
Received Calls	
Dialed numbers	
Phone Book	
Enterprise phone book	Not functional at this time
Personal phone book	Not functional at this time
Messaging	Not functional at this time
Create Message	Not functional at this time
Inbox	Not functional at this time
System Settings	
Phone Settings	
Language	English only is available at this time
Volume Settings	
Ring Volume	Levels 1 – 9 possible
Handset Volume	Levels 0 – 9 possible
Handset Microphone Volume	Levels 0 – 7 possible
Speaker Volume	Levels 0 – 9 possible
Speaker Microphone Volume	Levels 0 – 7 possible
Headset Volume	Levels 0 – 9 possible
Headset Microphone Volume	Levels 0 – 9 possible
Ring Type	Bellcore-DR1 – 8, you may select from files that are uploaded
Brightness	Level 1 – 5
Backlight	Timer/Always On/ Always Off
Contrast	Level 1 – 5
Advanced Settings	Password Protected – at default password is <blank>
Network	Various settings for network connection
VLAN	LAN/PC Port VLAN settings
SIP	Global/Accounts/Auto Provision
Load Default Settings	Are you sure you want to do that?
Reboot	Restart the phone
Modify Password	
TR069	Boot-up configuration method – not yet supported
View Settings	
Network	
Lines	
Software	
Expansion	
Diagnose	
Keys	Enter into mode and press one key a t a time to check response
LCD	Lights LCD at full brightness
Lights	Press “OK” to cycle through all LED modes
Sound	Press “OK” for echo-repeat test
Expansion	Light/Keys test for Expansion Modules

43. Buttons and Codes

Personal Voicemail:		Dial this to access your personal voicemail box from your extension.
Voicemail Main:		Dial this to reach the voice mail system from any extension or the automated attendant.
Transfer to Voicemail:	 + ext #	Use this to transfer a caller directly to someone's mailbox when you don't want to ring their extension
Directory:		IPitomy's directory and dial by name service
Blind Transfer:		Use this to transfer a caller when you don't need to speak to the party you are transferring to before sending them the call
Attended Transfer:		Use this when you want to ask the party if they would like to speak to the caller first before transferring
One Touch Record:		This will record the conversation (Requires Permission)
Pickup Extension:		Dial this to pick up a ringing extension from your phone
Directed Pickup Extension:	 + ext #	Dial this to pick up a specific extension.
Ring Group Page:	 + ext #	Dial this to page someone over their speaker phone
Pause Phone Queues:		Pause phone in all Queues (ACD Feature)
Un-pause Phone Queues:		Return phone to Queue (ACD Feature)
Pause Agent Queues:	 + Agent #	Pause agent in all queues (ACD Feature)
Un-pause Agent Queues:	 + Agent #	Return Agent to Queue (ACD Feature)
Agent Callback Login:		Following the in-call instructions allows for the agent to login at any phone. Once logged in, to log out you will follow the instructions, and when asked
Agent Login:		This logs the agent in at the phone the code was dialed at. In order to remain logged in, the phone must stay off-hook. To log out, simply hang up.
PBX Call Forward		PBX-based Call Forward. Enable/Disable access and voice prompted menu to input number where calls will be forwarded.
PBX Call Forward Destination		PBX-based Call Forward. Direct access to forward destination entry.
PBX Call Forward Cancel (disable)		PBX-based Call Forward. Direct access to disable function.