

# HEX HEAD CAP SCREWS

## SMALL PACKS

Grade 5

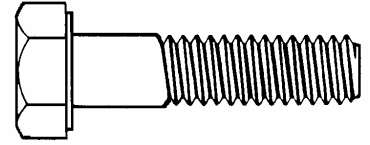

- Duraplate finish protects against rust and corrosion.
- 1038 Steel - double heat treated.
- Headmarked for complete traceability.

1/4" DIAMETER			
J&B #	SAE	LENGTH	QTY
3006	3506	1/2	50
3010	3510	3/4	50
3012	3512	1	50
3014	3514	1-1/4	25
3016	3516	1-1/2	25
3018		1-3/4	25
3020	3520	2	25
3022		2-1/4	25
3024	3524	2-1/2	25
3026		2-3/4	20
3028	3528	3	20
3032	3532	3-1/2	20
	3536	4	20

3/8" DIAMETER			
J&B #	SAE	LENGTH	QTY
3106		1/2	25
3110	3610	3/4	25
3112	3612	1	25
3114		1-1/4	25
3116	3616	1-1/2	20
3118		1-3/4	20
3120	3620	2	20
3122		2-1/4	15
3124	3624	2-1/2	15
3126		2-3/4	15
3128	3628	3	15
3132	3632	3-1/2	15
3136	3636	4	10
3138		4-1/2	10
3140		5	10
3142		5-1/2	10
3144		6	10

5/16" DIAMETER			
J&B #	SAE	LENGTH	QTY
3056	3556	1/2	50
3060	3560	3/4	50
3062	3562	1	25
3064		1-1/4	25
3066	3566	1-1/2	25
3068		1-3/4	25
3070	3570	2	25
3072		2-1/4	20
3074	3574	2-1/2	20
3076		2-3/4	20
3078	3578	3	15
3082	3582	3-1/2	15
3086	3586	4	15
3088		4-1/2	10
3090		5	10

# HEX HEAD CAP SCREWS

## SMALL PACKS

Grade 5

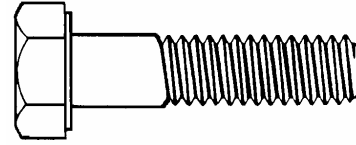

- Duraplate finish protects against rust and corrosion.
- 1038 Steel - double heat treated.
- Headmarked for complete traceability.

7/16" DIAMETER			
J&B #	SAE	LENGTH	QTY
3160		3/4	25
3162	3662	1	25
3164		1-1/4	20
3166	3666	1-1/2	20
3168		1-3/4	20
3170	3670	2	15
3172		2-1/4	15
3174	3674	2-1/2	15
3176		2-3/4	15
3178	3678	3	10
3182	3682	3-1/2	10
3186	3686	4	10
3188	3688	4-1/2	5
3190	3690	5	5
3192		5-1/2	5
3194		6	5

1/2" DIAMETER			
J&B #	SAE	LENGTH	QTY
3210		3/4	20
3212	3712	1	20
3214		1-1/4	20
3216	3716	1-1/2	20
3218		1-3/4	15
3220	3720	2	15
3222		2-1/4	15
3224	3724	2-1/2	15
3226		2-3/4	10
3228	3728	3	10
3232	3732	3-1/2	10
3236	3736	4	5
3238	3738	4-1/2	5
3240	3740	5	5
3242		5-1/2	5
3244		6	5

# BUMPER BOLTS

---

## ROUND HEAD

- Stainless steel capped for positive protection against weather.

J&B #	SIZE	QTY
10662	3/8-16 x 1	25
10665	7/16-14 x 1-1/4	25
10672	1/2-13 x 1-1/2	25

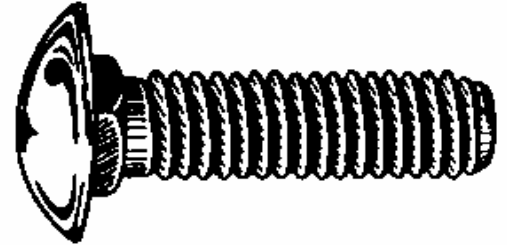

---

## PAN HEAD

- Stainless steel capped for positive protection against weather.

J&B #	SIZE	QTY
11860	3/8-16 x 1	25



J&B #	SIZE	QTY
11839	7/16-14 x 1-1/4	25

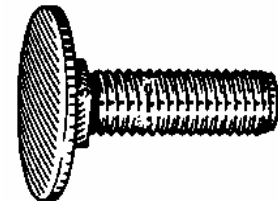

# BODY BOLTS

BLACK FINISH

## HEX SPIN LOCK

W/ Dog Point

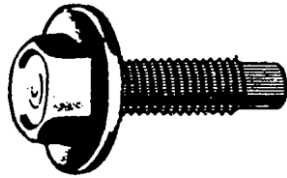

J&B#	SIZE	WASH. O.D.	QTY
12845	5/16-18 x 1	13/16	25
12847	5/16-18 x 1-1/4	13/16	25
12844	5/16-24 x 1	13/16	25

## HEX HEAD SEMS

W/ Dog Point

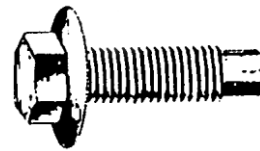

J&B#	SIZE	WASH. O.D.	QTY
13402	1/4-20 x 7/8	3/4	25
12504	1/4-20 x 1	5/8	25

## HEX SPIN LOCK

Without Dog Point

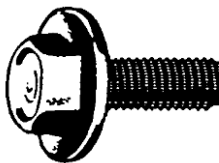

J&B#	SIZE	WASH. O.D.	QTY
12841	1/4-20 x 5/8	5/8	25

## HEX HEAD SEMS

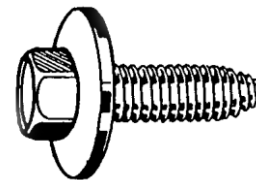

J&B#	SIZE	WASH. O.D.	QTY
38468	3/8-16 x 1	1"	25
10377	3/8-16 x 1-1/2	1-1/8	25

## HEX HEAD SEMS

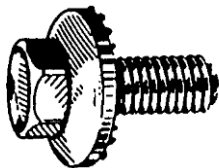

J&B#	SIZE	WASH. O.D.	QTY
10567	5/16-18 x 1	7/8	25

## HEX HEAD SEMS

W/ Dog Point

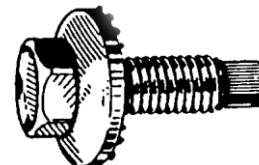

J&B#	SIZE	WASH. O.D.	QTY
10570	5/16-18 x 1-1/4	7/8	25

## HEX WASHER HEAD

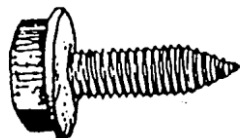

J&B#	SIZE	WASH. O.D.	QTY
12060	5/16-18 x 13/16	41/64	20
38499	5/16-18 x 3/4	21/32	100



# METRIC BODY BOLTS

---

## BLACK FINISH METRIC HEX HEAD SEMS

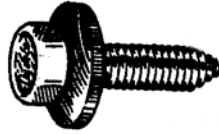

J&B #	SIZE	MATERIAL	WASH. OD	QTY
45410	M6-1.00 x 20mm	Phosphate	17mm	25
41841	M6-1.00 x 25mm	Phosphate	17mm	50
45418	M6-1.00 x 25mm	Phosphate	24mm	50
45888	M6-1.00 x 35mm	Phosphate	17mm	50
42004	M6-1.00 x 25mm	Black Polyseal	24mm	25
42008	M8-1.25 x 25mm	Phosphate	24mm	25
41882	M8-1.25 x 30mm	Phosphate	24mm	25
45802	M10-1.50 x 40mm	Phosphate	29mm	25

---

## METRIC HEX HEAD SEMS

W/ Dog Point

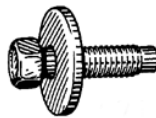

J&B #	SIZE	WASH. OD	QTY
42090	M6-1.00 x 22mm	19mm	25
45425	M6-1.00 x 28mm	19mm	25

---

## HEX WASHER HEAD

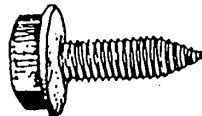

J&B #	SIZE	MATERIAL	WASH. OD	QTY
45814	M8-1.25 x 25mm	Black Polyseal	17mm	25

# BODY SHOP NUTS

## EXTRUDED "U" NUTS Standard

- Treated for corrosion resistance.
- High quality annealed steel.

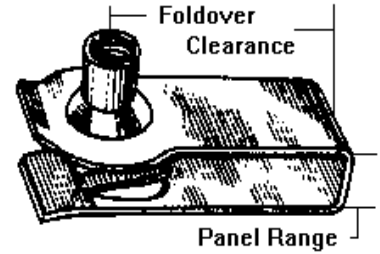

J&B #	THREAD	FOLDOVER CLEARANCE	PANEL RANGE	QTY
10525	1/4-20	1/2	.080 - .090	25
10527	1/4-20	3/4	.140 - .170	25
10530	5/16-18	9/16	.025 - .150	25
10556	5/16-18	9/16	.120 - .150	25
10536	5/16-18	27/32	.025 - .150	25
10533	3/8-16	1-1/8	.050 - .200	15

## EXTRUDED "U" NUTS Metric

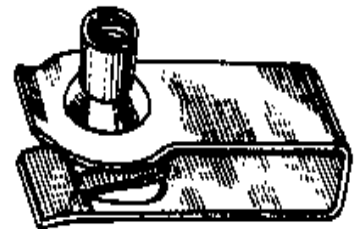

J&B #	THREAD	FOLDOVER CLEARANCE	PANEL RANGE	QTY
41876	6-1.0 mm	13.5 mm	.8 - 4.0 mm	50
42094	6-1.0 mm	13.5 mm	.8 - 4.0 mm	25
41878	6-1.0 mm	19.5 mm	.34 - 4.0 mm	25
42102	6-1.0 mm	19.5 mm	1.0 - 2.5 mm	50
10691	6.3 - 1.0 mm	13.5 mm	.8 - 4.0 mm	25
42000	8-1.25 mm	14.5 mm	.8 - 4.0 mm	25
41874	8-1.25 mm	20.0 mm	8 - 4.5 mm	25
42086	10-1.50 mm	19 mm	1.0 - 6.0 mm	25

## "J" TYPE CAGE NUTS

- High quality selected annealed steel.
- Heat treated at exacting temperatures to give maximum holding power and "spring back" action even after continuous use.















J&B #	THREAD	FOLDOVER CLEARANCE	PANEL RANGE	QTY
11654	1/4-20 (W/Square Nut)	1/2	.032 - .100	25
11610	5/16-18	15/32	.087 - .093	25
11637	3/8-16	9/16	.050 - .090	15

# BODY SHOP NUTS

## “U” & “J” TYPE NUTS

(Illustrations Actual Size)

- High quality selected annealed steel.
- Heat treated at exacting temperatures to give maximum holding power and “spring back” action.



J&B #	SCREW SIZE	PANEL RANGE	FOLDOVER CLEARANCE	QTY	
10414	# 8	.025 - .035	3/8	25	
10420	# 8	.025 - .040	3/8	25	
10327	# 6	.090 - .110	9/32	25	
10343	#10	.025 - .060	11/32	100	
11027	# 8	.025 - .040	9/32	25	
10421	# 8			25	
10347	1/4-20	.064 - .125	9/16	25	
10422	# 8	.025 - .150	3/8	25	
11705	#10	.045 - .062	13/32	25	
10425	#10	.025 - .064	3/8	25	
11024	#10	.025 - .062	9/32	25	
11034	#10	.030 - .037	3/8	25	

# BODY SHOP NUTS

## “U” & “J” TYPE NUTS

(Illustrations Actual Size)

- High quality selected annealed steel.
- Heat treated at exacting temperatures to give maximum holding power and “spring back” action.

J&B #	SCREW SIZE	PANEL RANGE	FOLDOVER CLEARANCE	QTY	
10329	# 8	.025 - .035	11/32	25	
45522	# 8	.025 - .150	5/8	25	
45800	# 8	.025 - .150	3/8	100	

## SHOCK ABSORBER NUT

J&B #	THREAD	THROAT DEPTH	PANEL RANGE	QTY	
42003	5/16-18	.370-.409	.154-.173	25	

## JACK NUT

- Zinc plated with raintite sealer.

J&B #	THREAD	GRIP RANGE	REQUIRED HOLE DIA.	QTY	
4235	1/4-20	1/64”-3/16”	.434-.450	15	











# BODY SHOP NUTS

## FLAT NUTS

(Illustrations Actual Size)

- High quality selected annealed steel.
- Heat treated at exacting temperatures to give maximum holding power and “spring back” action even after continuous use.

J&B #	STUD SIZE	QTY	
11036	1/16	50	
10485	5/64	50	
11037	3/32	50	
11038	7/64	50	
11039	1/8	50	
11040	5/32	50	
11042	3/16	50	
11041	5/32	50	

## CAGE NUTS

- Phosphatate plated.











J&B #	THREAD	PANEL RANGE	QTY
86065	1/4-20	.064 - .105	50
86066	5/16-18	.023 - .063	50



# BODY SHOP NUTS

## BARREL NUTS

(Illustrations Actual Size)

J&B #	STUD SIZE	PANEL RANGE	HOLE SIZE	QTY	
10393	1/8	.025 - .045	3/16	50	
11053	1/8	.030 - .036	5/32	50	
11006	1/8	.040 - .045	3/16	50	
11004	1/8	.038 - .044	5/32	50	
10492	3/16	.036 - .046	1/4	25	
10484	3/32	.032 - .040	1/8	50	
10482	3/16	.040 - .055	19/64	50	
11009		.039 - .045	.267 x .116	50	
10496	1/4	.034 - .040	9/32	50	
11008	1/8	.035 - .100	3/16	50	
11605	3/32	.031 - .041	1/8 x 5/32	50	

# BODY SHOP

---

## WELL NUT

Neoprene with Captive Brass Nut

J&B #	SIZE	OVERALL LENGTH	HOLE SIZE	QTY
55892	6-32	.981	1/4	25
55893	8-32	.499	5/16	25
55894	10-24	.767	3/8	25
55895	10-32	.807	3/8	25
55896	1/4-20	1.051	1/2	25
40908	M6-1.0	.630	1/2	25

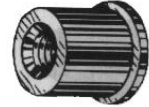

---

## DOOR HINGE REPAIR KIT

For GM,C/K Trucks & Full Size SUV '99 & up

- Economically repair worn out door hinge pins on vehicles with welded hinges without removing the hinge.
- Case hardened forged pins with dacromet (500 hour salt spray) finish.
- Bronze bushings, thru hardened washers and prevailing torq lock nuts.

\*\* Each kit contains...

2 pins  
2 bushings  
2 washers  
2 locknuts



J&B #	QTY
4238	1/KIT

# BODY SHOP NUTS

## SELF-THREADING NUTS

Zinc

J&B #	SIZE	WASHER O.D.	QTY
11534	1/8 Stud	17/32	100
12199	5/32 Stud	9/16	100
11535	3/16 Stud	5/8	100
11536	1/4 Stud	7/16	100
12217	5/16 Stud	7/8	50



## FLANGED PAL NUTS

Zinc

J&B #	SIZE	FLANGE	QTY
10623	10-24	3/4	100
10634	1/4-20	19/32	100
10719	1/4-20	13/16	100



## PUSHNUT BOLT RETAINER

For Threaded Fasteners

Phosphate

- Prevents screw or bolt from spinning.



J&B #	SIZE	O.D.	QTY
10370	1/4	1/2	100
10371	5/16	5/8	100
10372	3/8	25/32	100
10373	7/16	27/32	50
10374	1/2	15/16	50

## FLAT PUSH-ON RETAINER

For Non-Threaded Fasteners

Zinc

- No threads, notches or grooves required.



J&B #	SIZE	O.D.	QTY
10501	1/8	3/8	50

## PUSHNUT BOLT RETAINER

- \* Prevents screw or bolt from spinning.

For Threaded Fasteners

Dacromate



J&B #	SIZE	O.D.	QTY
42064	M8-1.25	24mm	50

# METRIC BODY NUTS

---

## HEX FLANGE NUT



J&B #	SIZE	FLANGE O.D.	QTY
42060	M8-1.25	17mm	25
45804	M10-1.50	21mm	25

## METRIC SPIN LOCK NUTS

With Serrations



J&B #	SIZE	O.D.	QTY
45852	M10-1.25	19mm	25

---

## FREE SPINNING WASHER NUT

Phosphate

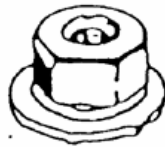

J&B #	SIZE	WASHER O.D.	HEX SIZE	QTY
41861	M6-1.0	16mm	10mm	25
10915	M6-1.0	19mm	11mm	25
10913	M6.3-1.0	16mm	11mm	25
10916	M8.0-1.25	24mm	13mm	25

---

## FREE SPINNING WASHER NUT











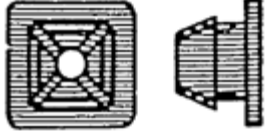
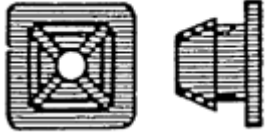

J&B #	SIZE	WASHER O.D.	HEX SIZE	MATERIAL	QTY
45580	M6-1.0	18mm	10mm	PHOSPHATE	50
45581	M6-1.0	19mm	10mm	ZINC	50
45842	M6-1.0	20mm	10mm	PHOSPHATE	50

---







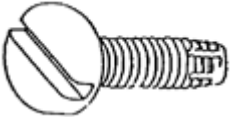

# LICENSE PLATE FASTENERS

## ZINC PLATED SCREWS



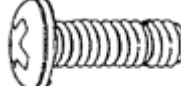
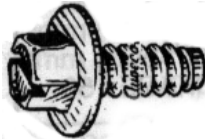



J&B #	DESCRIPTION	QTY	
41436	Hole: M9.5 Screw #14	100	
10583	Hole: 3/8 Screw #14	50	
12069	14 x 3/4 Round Slotted Truss Head	100	
10589	1/4-20 x 3/4 Slotted Truss Head	100	
11301	14 x 3/4 Slotted Hex Washer Head	50	
46119	6-1.00 x 12mm Pan Head Phillips Black Nylon License Plate Screw	100	
46120	6-1.00 x 16mm Pan Head Phillips Black Nylon License Plate Screw	100	
46121	6-1.00 x 16mm Pan Head Phillips Black Nylon License Plate Screw	1000	
46122	6-1.00 x 20mm Pan Head Phillips Black Nylon License Plate Screw	100	
46123	6-1.00 x 20mm Pan Head Phillips Black Nylon License Plate Screw	1000	
46124	6-1.00 Nylon Hex Nut Black	100	

# LICENSE PLATE FASTENERS

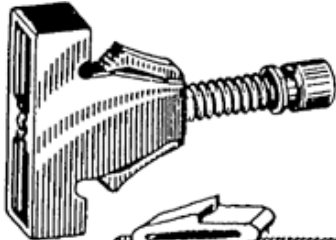
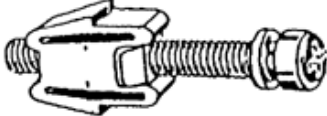
## ZINC PLATED SCREWS

J&B #	DESCRIPTION	QTY	
12906	1/4-20 x 5/8 Slotted Pan Head	100	
10360	#8	25	
10768	#10 x 5/8 Slotted Truss Washer Head	100	
10474	#14 x 5/8 Slotted Truss Head with Dog Point	50	
11120	6mm - 1.00 x 20mm Phillips Pan Machine Screw	100	
40909	#14 x 5/8 Slotted Hex Washer Head	50	
40913	6 – 1.81 x 20mm Phil Hex wash hd 12mm Wshr Hd. O.D. 10mm Hex Zinc Plt.	50	
40916	#14 x 3/4 Sl. Hex Wash Hd. 1/2 wash hd O.D. 3/8 Hex Black E-Coat	50	
59130	M6-1.0 x 20mm Sl. Hex Wash Hd. 13mm (1/2") Wshr Hd. O.D. 10mm Hex	50	
59132	#10 x 3/4" Phil Flt Wash Hd. 15/32 Wash Hd. O.D. Black E-Coat	100	









# HEADLIGHT ASSEMBLIES

J&B #	SIZE	TYPE	QTY	
11888	12-28 x 1-3/8	Screw & Nut	5	
11660	12-28 x 1-1/2	Screw & Nut	10	
13461	1/4-28 x 2	Screw & Nut	10	
13462		Nut	25	
11656		Nut	20	
10498	1/4-28 x 1-1/2	Screw	25	
10590	#8 Screw size 5/16 hole GM 1967-On	Nylon bezel nut	50	











# NYLON NUTS









(Illustrations Actual Size)

J&B #	SIZE	DESCRIPTION	QTY	
10583	1/4" Screw	GM License Plate	50	
10360	# 8 Screw	CHRYSLER Headlamp Door & Rear License Plate	25	
11927	# 8 Screw	GM Front End & Panel	25	
11842	# 8 - #10 Screw 1/4 Hole	FORD Universal Use	25	
12038	# 6 or # 8 Screw	AMC	25	
11702		GM Door Trim Pad	25	
25119		CHEVROLET Headlamp Bezel	25	
11670		BUICK Grill Nut	25	
11742	#10 Screw 5/16 Hole		25	







# TRIM CLIPS

J&B #	SIZE	DESCRIPTION	QTY	
45896	8mm	Push type Retainer Front Fender Civic & Del Sol 93' - On	15	
45900	8mm	Front Fender Push- Type Retainer Acura 3.5RL, Honda Accord, Prelude & Odyssey 94' - On	25	
45898	10mm	Front Bumper Push- type Retainer 3.5RL Sedan 96' - On	15	
45880	6mm	Hood Insulation Retaining Clip Honda & Accura 90' - On	25	
45890	9mm	Rear Bumper Cover Push-type Retainer Tercel 88' - On	4	
45894	6mm	Hood & Trunk Moulding Retaining Clip Acura Integra & Honda Civic 94' - On	10	
45892	6mm	Weatherstrip Retainer Acura 3.5 RL & Honda Accord, Civic & Odyssey 92' - On	25	
41937	8mm	Nissan/Infiniti Push- Type Retainer Black Nylon 2002-On	15	
59119	8mm	Hyundai, Accent, Azera, Elantra, Sonata, Tucson, Kia Amanti, Borrego, Cadenza, Forte, Rio, Rondo, Sedona, Soul	50	

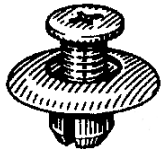
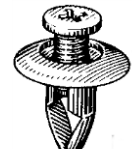

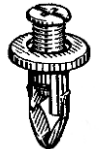

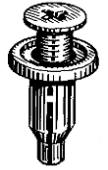

# TRIM CLIPS

J&B #	SIZE	DESCRIPTION	QTY	
40911	6mm	Screw grommet Lexus & Toyota Fits into 8mm hole	25	
40927	9mm	Bumper push-type Retainer Honda & Mitsubishi 98-On.	15	
40928	8mm	Push-type Retainer Maxima 94-On	15	
40929	9mm	Hood & Fender Screw grommet Camry & RAV 4 Fits into 9mm hole	15	
40931	10mm	Front & Rear bumper retainer Honda Accord & Odyssey 96-on	15	
59140	10mm	Bumper Cover & grille retainer 19.5mm Head Mazda 99-on	10	
59141	7mm	Front Fender Liner 18mm Head Celica, Corolla, Matrix & Solara, Lexus & Pontiac Vibe 99-on	10	
59142	10mm	Front Bumper Retainer w/ metal insert 20mm Head Civic 2006-on	10	

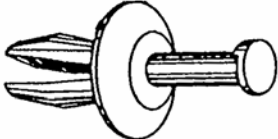



# TRIM CLIPS

J&B #	SIZE	DESCRIPTION	QTY	
45850	8mm	Push type Retainer	25	
45856	8mm	Inner Fender Retainer Nissan 80' - On	25	
45902	10mm	Bumper Push-type Retainer 240SX & Maxima 94-On	15	
45862	10mm	Push -type Retainer Accord 90' - On Bumper Fascia	10	
45870	8mm	Fender Splash Sheild Push-type Retainer Accord 90' - On	10	
45872	8mm	Push-type Retainer Mazda & Ford Aspire	10	
45882	10mm	Front & Rear Bumper Push-type Retainer Honda 90' - On	10	
59138	8mm	Front & Rear Bumper Cover Retainer Maxima & Infiniti 90' - On	15	
40397	8mm	Push-type Retainer Maxima & 300ZX 94' - On	15	



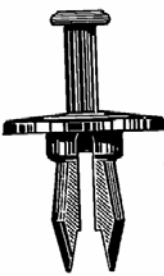

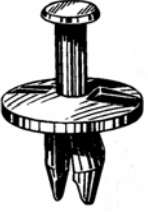
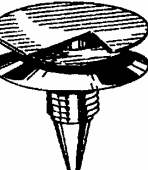
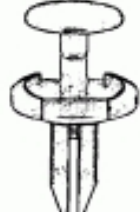



# TRIM CLIPS

J&B #	DESCRIPTION	MAKE & YEAR	QTY	
11270	Hood Retainer	GM '64 - On	25	
40090	Front Fender Mud Skirt	GM '81 - On	25	
11387 41840	Radiator Yoke, Fender & Bumper Shield	GM, FORD, CHRYSLER	25 100	
11581 13397	Black Shield Retainer	GM, FORD, CHRYSLER, AMC	25 50	
13406	Gray Shield Retainer	GM '73 - On	25	
11989	Door Trim Panel & Headliner	GM '71 - On	25	
45876	Shield Retainer	GM '89 - On	50	





# TRIM CLIPS

J&B #	DESCRIPTION	MAKE & YEAR	QTY	
42066	Fascia Retainer	GM '79 - On	15	
42068	Front End Stone Retainer	GM '81 - On	25	
45810	Radiator Apron Panel Retainer	GM '77 - On	25	
42100	Nylon Radiator Shroud Retainer	GM '82 - On Ford '86 - On	25	
45430	Fascia Retainer	GM '82 - On	25	
45436	Door Trim Panel Retainer	GM '78 - On	50	
40917	Radiator, Wheel-House, Fender, & front bumper cover	GM C & K Trucks 99 - On Jeep Liberty 02 - On	25	

# TRIM CLIPS

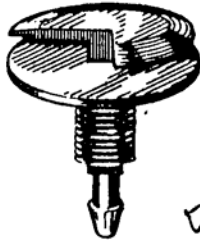

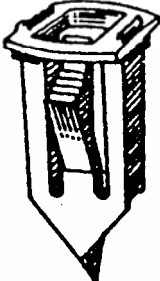
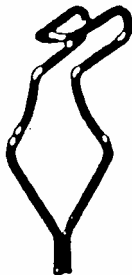
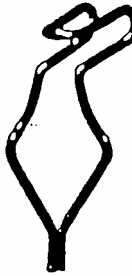



J&B #	DESCRIPTION	MAKE & YEAR	QTY	
45864	Air Baffle to Under Carriage Push-type Retainer	GM '91 - On	25	
45866	Push-type Retainer 8mm hole	GM '91 - On	25	
45878	Push-type Retainer 1/4 hole	GM '92 - On Dodge '93 - On	25	
45794	Trim Panel Trunk Lid Latch	1993 - On Ford Explorer 1996 - On Chrysler	50	
45796	Fascia to Bumper Retainer	Ford 81 - On	25	
45798	Trunk Trim Retainer	GM	25	
59143	Air inlet grille, bumper fascia & front brake caliper cooling duct 6.5 Hole	Buick enclave, Cadillac CTS & STS, Chevy cobalt, Equinox & SSR GM trucks & Pontiac G5 & torrent 2002-on	50	
59144	Cowl vent & fender push-type retainer 8.5mm Hole	Buick century, LaCrosse & Regal, Cadillac, chevy equinox, GM trucks, Hummer H3 & pontiac grand prix & torrent 97-on Ford 2006-on	25	

# TRIM CLIPS

J&B #	DESCRIPTION	MAKE & YEAR	QTY	
11946	Trim Panel	FORD '76 - On	25	
10396	Door Weatherstrip	FORD	25	
11310	Hood Insulation	FORD, CHRYSLER '73 - On	25	
11408	Headliner Clip	GM '73 - On	8	
12669	Door Trim Panel Fastener	FORD	25	
11056	Door Trim Panel Fastener	FORD	25	
45868	Weatherstrip Retainer	LINCOLN 89' - On	50	



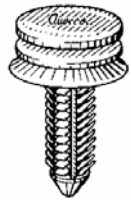



# TRIM CLIPS

J&B #	DESCRIPTION	MAKE & YEAR	QTY	
45818	Door Trim Panel Retainer	FORD '81 - On	25	
45822	Trim Panel Retainer Black Nylon	FORD 80' - On		
45838	Splash Shield & Facia Retainer	GM, Ford	25	
45843	Hood Insulation Retainer	GM 80' On	25	
45854	Front Door Trim Panel Retainer	GM 82' On	25	
45906	Push type Retainer	INTREPID & EAGLE 98' On	25	
45826	Door Trim Panel Retainer	GM '83 - On	25	

# MOULDING FASTENERS

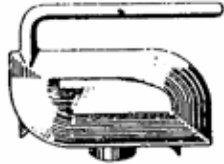
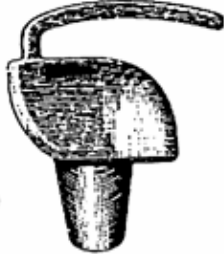
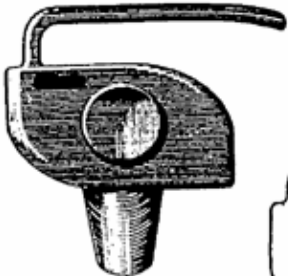
## NYLON

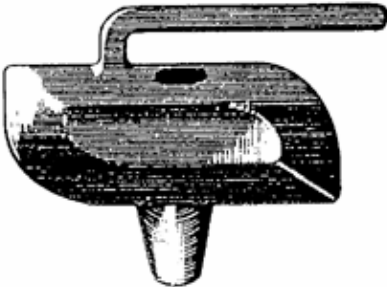

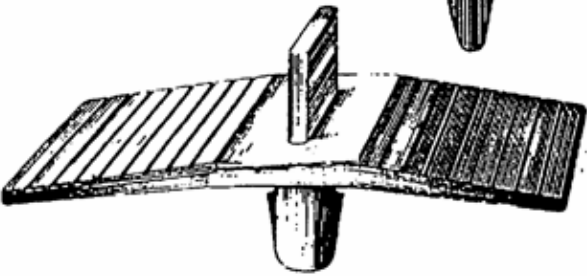
(Illustrations Actual Size)

J&B #	DESCRIPTION	QTY	
10315	Front & Rear Door Mould	25	
10316	Front & Rear Door & Quarter Panel Mould	25	
10317	Rear Fender Lower Mould	20	
10318	Rear Fender Lower Mould	15	
10319	For 1-1/4 to 1-3/4 Mould	12	
11952	Fits 1/2 to 5/8 Moulding	25	
10320	Mould Fast Break off Plate	10	

# MOULDING FASTENERS

## METAL

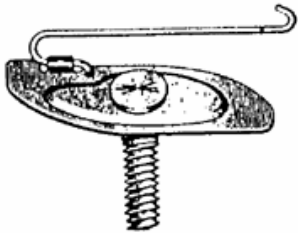

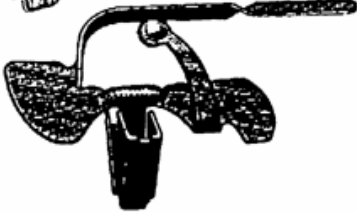



(Illustrations Actual Size)

J&B #	DESCRIPTION	QTY	
10303	10-24 x 5/8 Bolt	25	
10307	10-24 x 3/4 Bolt	25	
10365	General Purpose	15	
11638		10	

# MOULDING FASTENERS

## REVEAL CLIPS

(Illustrations Actual Size)

J&B #	DESCRIPTION	MAKE & YEAR	QTY	
11809	Rear Window	GM '65 - On	25	
12087	Windshield - Upper & Lower	GM '67 - On	25	
12058	Rear Window	GM '69 - On	25	
11811	Rear Window	GM '69 - On	25	
10696	Windshield & Rear Window	Ford '68 - On	25	
13662	Belt Reveal Moulding	GM '76 - On	25	

## ROCKER PANEL

J&B #	MAKE & YEAR	QTY	
11968	GM '80 - On	25	

# BODY SHOP

## THROTTLE CLIPS



LEFT HAND TYPE			
J&B #	DIA.	IND. STD.	QTY
10937	5/32	# 2L	25
10939	3/16	# 4L	25

RIGHT HAND TYPE			
J&B #	DIA.	IND. STD.	QTY
10938	5/32	# 2R	25

## REMOTE CONTROL ROD TO DOOR LOCK CLIP

J&B #	QTY
40125	50

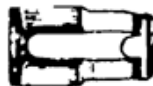

## ADJUSTING SPRINGS

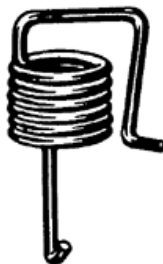

J&B #	DESCRIPTION	QTY
10577	OLDS	10

## DOOR HANDLE CLIP



J&B #	QTY
10922	50

## HOG RING (Medium)



J&B #	QTY
10923	100

# BODY SHOP

---

## ROUTING CLIPS



J&B #	ID	OD.	QTY
45840	1/2	11/16	25

## RADIATOR GRILLE RETAINER

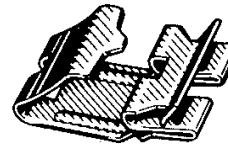

- GM Pickup, Van, Blazer, Jimmy 94- On

J&B #	QTY
45886	25

---

## HEADLIGHT COMPONENT RETAINING CLIP

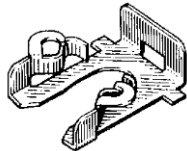

- Ford Taurus, T-Bird, Mercury Cougar & Sable 89'- On

J&B #	QTY
45848	25

## RADIATOR GRILLE NUT



- #8 Grille Nut #8 Screw Size GM Trucks C & K, 1, 2 & 3 1993-On

J&B #	QTY
59139	25

# PLUGS

## DRAIN PLUGS W/GASKET

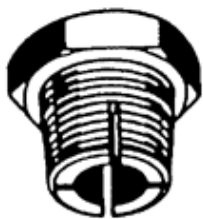

1/2-20 DOUBLE OVERSIZE	
J&B#	QTY
20021	10

1/2-20 OVERSIZE	
J&B #	QTY
20022	10

1/2-20 STANDARD	
J&B #	QTY
20023	10

## PLUG BUTTONS

J&B #	HOLE SIZE	HEAD DIA	QTY
11161	1/4	13/32	50
11162	3/8	1/2	50
11163	1/2	21/32	25
11164	5/8	13/16	25
11165	3/4	15/16	20
11166	7/8	1-1/16	20
11167	1	1-1/8	10



- Nickel Plated

# INSULATED TUBING CLAMPS

## STANDARD TYPE Zinc Plated

- 1/32" thick black vinyl plastic coating.
- Resists abrasions and chemical action.



J&B #	D	H	L	W	G	S	QTY
	INSIDE DIA.	HOLE DIA.	CENTER TO CENTER	WIDTH	GAUGE	SLOT LENGTH	
13357	1/4	9/32	17/32	1/2	.032	3/8	25
13358	5/16	9/32	9/16	1/2	.032	3/8	25
13359	3/8	9/32	19/32	1/2	.032	3/8	25
13360	1/2	9/32	21/32	1/2	.048	3/8	25
13361	5/8	9/32	23/32	1/2	.048	3/8	15
13362	3/4	9/32	25/32	1/2	.048	3/8	10

## EXTRA HEAVY DUTY TYPE Zinc Plated

J&B #	D	H	L	W	G	S	QTY
	INSIDE DIA.	HOLE DIA.	CENTER TO CENTER	WIDTH	GAUGE	SLOT LENGTH	
38720	1/4	13/32	21/32	3/4	.032	1/2	25
38722	5/16	13/32	11/16	3/4	.032	1/2	25
38724	3/8	13/32	23/32	3/4	.032	1/2	25
38726	1/2	13/32	25/32	3/4	.048	1/2	25
38728	5/8	13/32	27/32	3/4	.048	1/2	25
38730	3/4	13/32	29/32	3/4	.048	1/2	25
13363	1	13/32	1-1/32	3/4	.048	1/2	10
13364	1-1/4	13/32	1-5/32	3/4	.048	1/2	10
38732	1-1/2	13/32	1-9/32	3/4	.048	1/2	10
38733	1-3/4	17/32	1-17/32	1	.048	5/8	10
38734	2	9/16	2	1	.048	5/8	10

## NYLON TYPE

J&B#	WIDTH	TUBE DIA.	QTY
10436	3/8	1/4	20
10437	3/8	5/16	20
10438	3/8	3/8	20
10439	3/8	1/2	20
10445	3/8	5/8	20



- Secure cable, tubing, wires, fiber optics, etc. with these high quality nylon cable clamps.



# CLAMPS

## LOOM CLAMPS Carbon Steel Plated

- Carbon steel loom clamps have a higher ductility and are susceptible to less fatigue than other metal loom clamps.
- Ideal for applications that are constantly in high vibration and harsh environments.
- Plated with zinc/gold chromate; Removable EPDM jacket.



J&B #	INSIDE DIA.	MOUNTING HOLE DIA.	WIDTH	BOLT SIZE	QTY
45240	1/4	13/32	5/8	3/8	10
45241	3/8	13/32	5/8	3/8	10
45242	1/2	13/32	5/8	3/8	10
45243	5/8	13/32	5/8	3/8	10
45244	3/4	13/32	5/8	3/8	10
45246	1"	13/32	5/8	3/8	10
45248	1-1/4	13/32	5/8	3/8	10
45250	1-1/2	13/32	5/8	3/8	10
45251	2"	13/32	5/8	3/8	10
45460	2-1/2	13/32	5/8	3/8	10

## LOOM CLAMPS Stainless Steel

- Stainless steel loom clamps have a removable EPDM cushion which helps cut vibration while protecting the loom or cables.
- Typical applications include holding hydraulic hoses, wire harnesses and cables.



J&B #	INSIDE DIA.	MOUNTING HOLE DIA.	WIDTH	BOLT SIZE	QTY
45225	1/4	17/64	1/2	1/4	10
45226	3/8	17/64	1/2	1/4	10
45227	1/2	17/64	1/2	1/4	10
45228	5/8	17/64	1/2	1/4	10
45229	3/4	17/64	1/2	1/4	10
45230	1"	17/64	1/2	1/4	10
45232	1-1/4	17/64	1/2	1/4	10
45234	1-1/2	17/64	1/2	1/4	10

# SHIMS

## BODY ALIGNING SHIMS

J&B #	DIMENSION S	SLOT	THICK- NESS	QTY
10469	1-1/4 x 1-1/8	3/8	1/16	50
10470	1-1/4 x 1-1/8	3/8	1/8	50

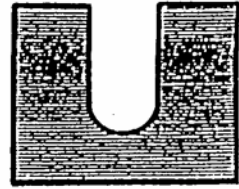

J&B #	DIMENSION S	SLOT	THICK- NESS	QTY
10471	1-3/4 x 1-1/4	1/2	1/16	50
10472	1-3/4 x 1-1/4	1/2	1/8	50

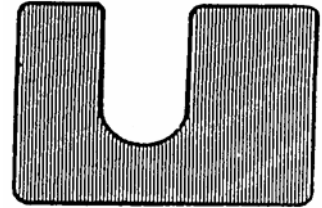

J&B #	DIMENSION S	SLOT	THICK- NESS	QTY
20101	1-1/8 x 1-1/8	1/2	1/16	50
20102	1-1/8 x 1-1/8	1/2	1/8	50

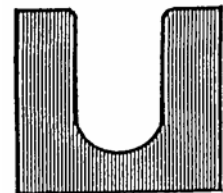

# SHIMS

## UNIVERSAL ALIGNMENT SHIMS

J&B #	DIMENSIONS	SLOT	THICK- NESS	QTY
40625	1-3/16 x 1-15/32	5/8	1/64	25
40626	1-3/16 x 1-15/32	5/8	1/32	25
40627	1-3/16 x 1-15/32	5/8	1/16	25
40628	1-3/16 x 1-15/32	5/8	1/8	25

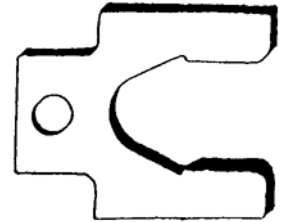

## CASTERS & CHAMBER SHIMS GM

J&B #	DIMENSION S	BOLT OPENING	THICK- NESS	QTY
20204	1 x 1-11/16	37/64	1/32	50

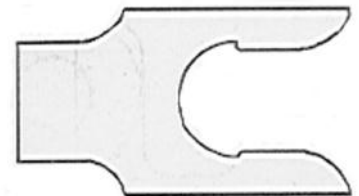

# UNIVERSAL SPRINGS

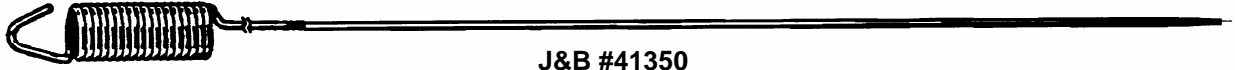

J&B #41350



J&B #41351

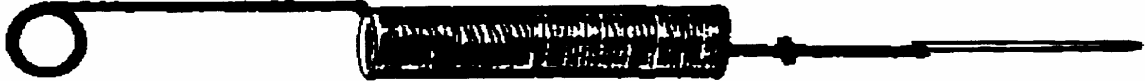

J&B #41353



J&B #41354



J&B #41356



J&B #41360



J&B #41357



J&B #41359

J&B #	LENGTH OVERALL	COIL LENGTH	O.D.	WIRE SIZE	QTY
41350	18-1/2	2	13/16	3/32	10
41351	17-1/2	3-1/2	3/4	1/16	10
41353	11-1/2	1-7/8	13/32	1/32	10
41354	8-1/2	1-7/8	3/4	3/32	10
41356	8-1/4	2	7/16	1/16	10
41357	5-3/4	2-3/8	25/32	3/64	10
41359	1-13/16	1-1/2	3/8	1/32	10
41360	4-3/8	2-1/2	1/2	1/16	10

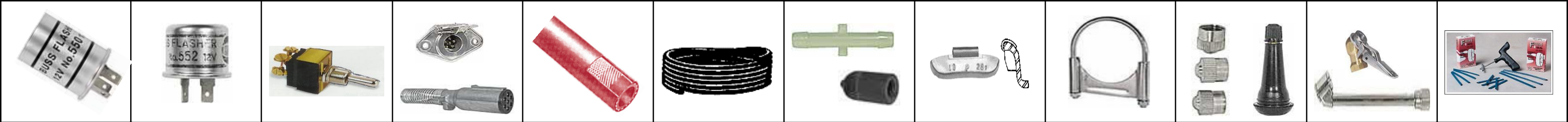

# J&B Fleet - Industrial Supply

www.jbfleet.com

22428 Harrisburg-Westville Rd. Alliance, Ohio 44601 Phone: (330) 821-6342 Fax: (330) 821-0411

## METRIC BODY BOLTS & NUTS

### PART # 2237

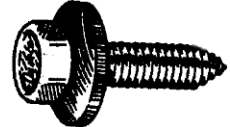
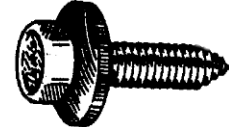
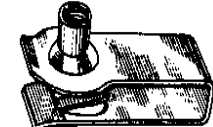
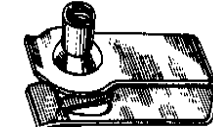
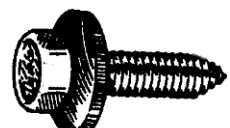
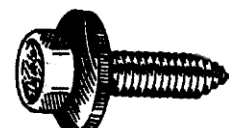
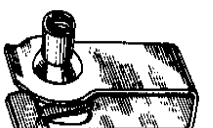
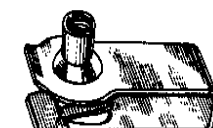
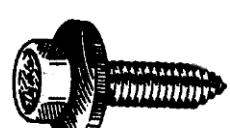
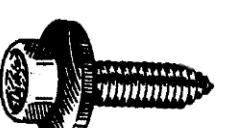
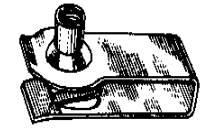
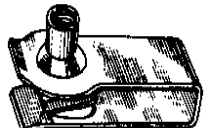
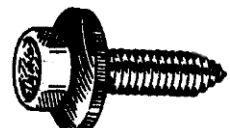
<p>10</p> <p><b>45410</b></p>  <p><b>M6-1.00 x 20 WASHER OD 17MM</b></p>	<p>5</p> <p><b>42008</b></p>  <p><b>M8-1.25 x 25 WASHER OD 24MM</b></p>	<p>10</p> <p><b>42094</b></p>  <p><b>6-1.0MM CLEARANCE 13.5MM RANGE .8 - 4.0MM</b></p>	<p>5</p> <p><b>42000</b></p>  <p><b>8-1.25MM CLEARANCE 14.5MM RANGE .8 - 4.0MM</b></p>
<p>10</p> <p><b>41841</b></p>  <p><b>M6-1.00 x 25 WASHER OD 17MM</b></p>	<p>5</p> <p><b>41882</b></p>  <p><b>M8-1.25 x 30 WASHER OD 24MM</b></p>	<p>10</p> <p><b>41878</b></p>  <p><b>6-1.0MM CLEARANCE 19.5MM RANGE .34 - 4.0MM</b></p>	<p>5</p> <p><b>41874</b></p>  <p><b>8-1.25MM CLEARANCE 20.0MM RANGE .8 - 4.5MM</b></p>
<p>10</p> <p><b>45418</b></p>  <p><b>M6-1.00 x 25 WASHER OD 24MM</b></p>	<p>5</p> <p><b>45802</b></p>  <p><b>M10-1.50 x 40 WASHER OD 29MM</b></p>	<p>10</p> <p><b>42102</b></p>  <p><b>6-1.0MM CLEARANCE 19.5MM RANGE 1.0 - 2.5MM</b></p>	<p>5</p> <p><b>42086</b></p>  <p><b>10-1.50MM CLEARANCE 19MM RANGE 1.0 - 6.0MM</b></p>
<p>10</p> <p><b>42004</b></p>  <p><b>M6-1.00 x 25 WASHER OD 24MM</b></p>			

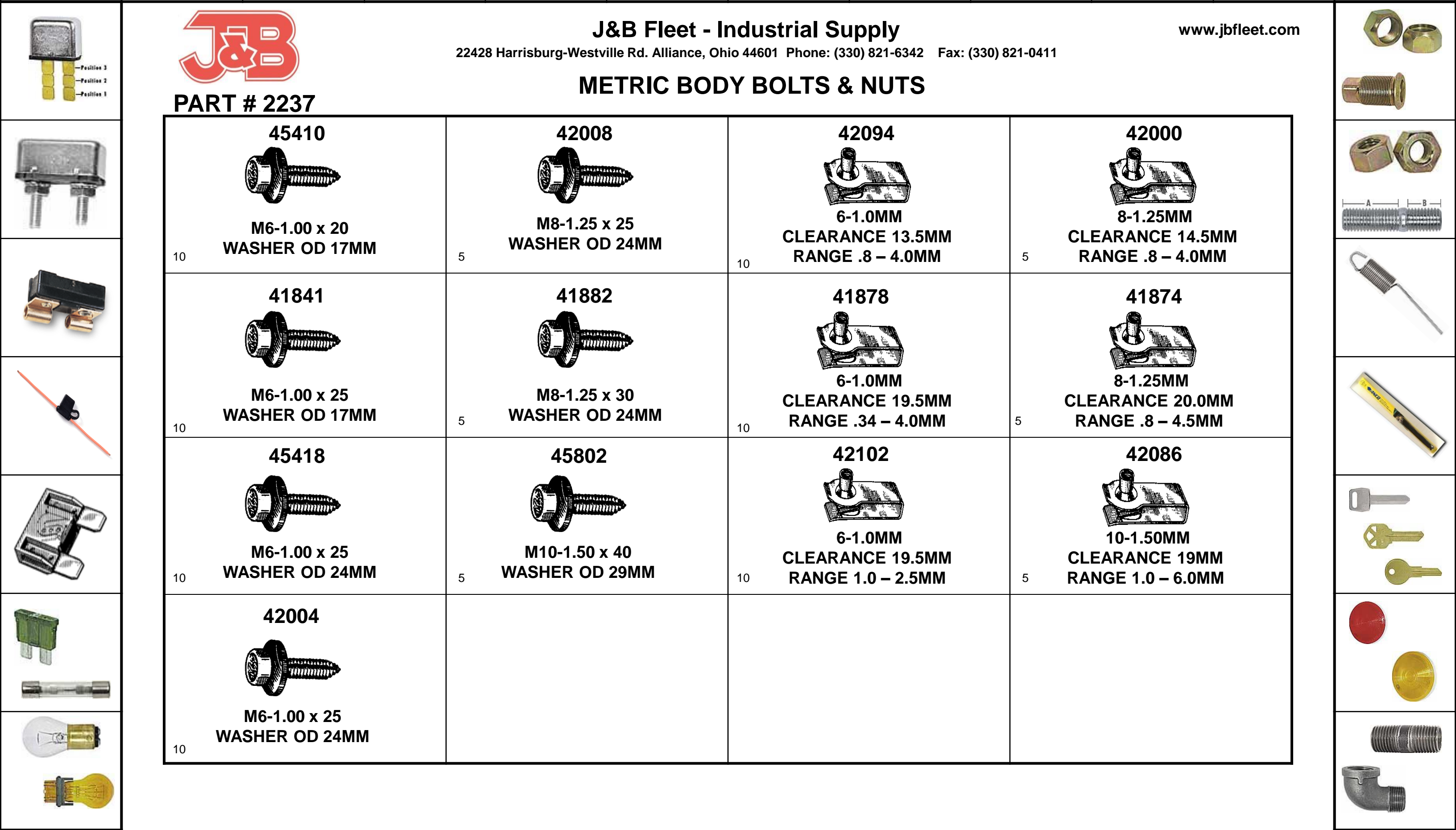



































# J&B Fleet - Industrial Supply

www.jbfleet.com

22428 Harrisburg-Westville Rd. Alliance, Ohio 44601 Phone: (330) 821-6342 Fax: (330) 821-0411

PART # 2294

## RETAINERS

 <b>45838</b> 1 GM FORD PUSH PIN 10	 <b>59144</b> 2 GM FORD PUSH PIN 10	 <b>59142</b> 3 HONDA PUSH PIN 5	 <b>59143</b> 4 GM FORD PUSH PIN 10	 <b>45878</b> 5 GM CHRYSLER PUSH PIN 10	 <b>45850</b> 6 GM PUSH PIN 10	 <b>45866</b> 7 GM PUSH PIN 10	 <b>42100</b> 8 GM FORD PUSH PIN 10
 <b>45902</b> 9 NISSAN PUSH PIN 5	 <b>45862</b> 10 HONDA PUSH PIN 5	 <b>45870</b> 11 HONDA PUSH PIN 5	 <b>45872</b> 12 MAZDA FORD PUSH PIN 5	 <b>45882</b> 13 HONDA PUSH PIN 5	 <b>59138</b> 14 NISSAN PUSH PIN 5	 <b>45864</b> 15 GM FORD CHRYSLER PUSH PIN 10	 <b>45856</b> 16 NISSAN PUSH PIN 10
 <b>45896</b> 17 HONDA PUSH PIN 5	 <b>45900</b> 18 HONDA PUSH PIN 10	 <b>45898</b> 19 HONDA PUSH PIN 5	 <b>40927</b> 20 HONDA ACURA PUSH PIN 5	 <b>40928</b> 21 HONDA MITSUBISHI PUSH PIN 5	 <b>40931</b> 22 HONDA PUSH PIN 5	 <b>59140</b> 23 MAZDA PUSH PIN 5	 <b>59141</b> 24 TOYOTA LEXUS PONTIAC PUSH PIN 5
 <b>11581</b> 25 SHORT RETAINER 5/16 DIA 10	 <b>11387</b> 26 MEDIUM RETAINER 5/16 DIA 10	 <b>45876</b> 27 LONG RETAINER 5/16 DIA 10	 <b>45796</b> 28 LG HEAD RETAINER 5/16 DIA 10	 <b>45794</b> 29 MEDIUM RETAINER 3/8 DIA 10	 <b>42068</b> 30 LONG RETAINER 7/16 DIA 10	 <b>45798</b> 31 GM TRUCK BUMPER FACIA 10	 <b>45880</b> 32 HONDA ACURA RETAINER 10

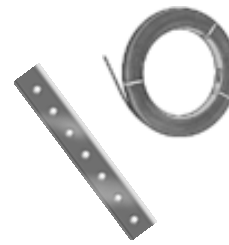

LET US HELP YOU MAKE THE CONNECTION

**PART# 3098**



**WELL NUTS**



J & B FLEET-INDUSTRIAL SUPPLY  
PHONE: 330-821-6342

<b>55892</b>	<b>55893</b>	<b>55894</b>	<b>55895</b>	<b>55896</b>	<b>40908</b>
<b>6 - 32</b>	<b>8 - 32</b>	<b>10 - 24</b>	<b>10 - 32</b>	<b>1/4 - 20</b>	<b>M6 - 1.0</b>
<b>1/4 HOLE</b>	<b>5/16 HOLE</b>	<b>3/8 HOLE</b>	<b>3/8 HOLE</b>	<b>1/2 HOLE</b>	<b>1/2 HOLE</b>
10	10	10	10	10	10

LET US HELP YOU MAKE THE CONNECTION

PART # 3041



# SELF-THREADING NUTS



J & B FLEET-INDUSTRIAL SUPPLY  
PHONE: 330-821-6342

<b>11534</b>  1/8 STUD 17/32 OD  50	<b>12199</b>  5/32 STUD 9/16 OD  50	<b>11535</b>  3/16 STUD 5/8 OD  50		<b>11536</b>  1/4 STUD 7/16 OD  50	
<b>12217</b>  5/16 STUD 7/8 OD  25		<b>10623</b>  10-24 3/4 FLANGE  50		<b>10634</b>  1/4-20 19/32 FLANGE  50	



LET US HELP YOU MAKE THE CONNECTION

PART # 3103



J&B FLEET-INDUSTRIAL SUPPLY  
PHONE: 330-821-6342

## PUSH ON NUTS

**10370**



1/4"

50

**10371**



5/16"

50

**10372**



3/8"

50

**10373**



7/16"

25

**10374**



1/2"

25

**42064**



M8-1.25

25

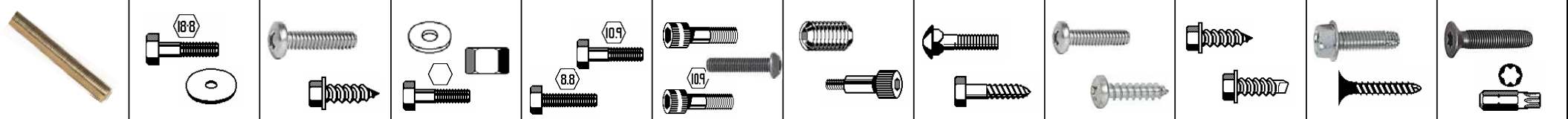

























# J&B Fleet - Industrial Supply

22428 Harrisburg-Westville Rd. Alliance, Ohio 44601 Phone: (330) 821-6342 Fax: (330) 821-0411

[www.jbfleet.com](http://www.jbfleet.com)

PART # 2212

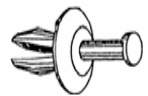
## RETAINERS

<p>11387 <sup>1</sup></p>  <p>RADIATOR YOKE</p> <p>15</p>	<p>11581 <sup>2</sup></p>  <p>BLACK SHIELD RETAINER</p> <p>15</p>	<p>11989 <sup>3</sup></p>  <p>DOOR TRIM PANEL &amp; HEADLINER</p> <p>15</p>	<p>45876 <sup>4</sup></p>  <p>SHIELD RETAINER</p> <p>15</p>	<p>42068 <sup>5</sup></p>  <p>FRONT END STONE RETAINER</p> <p>10</p>	<p>45810 <sup>6</sup></p>  <p>RADIATOR APRON PANEL RETAINER</p> <p>15</p>
<p>45436 <sup>7</sup></p>  <p>DOOR TRIM PANEL RETAINER</p> <p>15</p>	<p>45818 <sup>8</sup></p>  <p>DOOR TRIM PANEL RETAINER</p> <p>15</p>	<p>45826 <sup>9</sup></p>  <p>DOOR TRIM PANEL RETAINER</p> <p>15</p>	<p>45854 <sup>10</sup></p>  <p>FRONT DOOR TRIM PANEL RETAINER</p> <p>10</p>	<p>45822 <sup>11</sup></p>  <p>TRIM PANEL RETAINER BLACK NYLON</p> <p>15</p>	<p>45843 <sup>12</sup></p>  <p>HOOD INSULATION RETAINER</p> <p>10</p>
<p>45794 <sup>13</sup></p>  <p>TRIM PANEL RETAINER</p> <p>10</p>	<p>45796 <sup>14</sup></p>  <p>FASCIA TO BUMPER RETAINER</p> <p>10</p>	<p>45798 <sup>15</sup></p>  <p>BUMPER FASCIA RETAINER</p> <p>5</p>	<p>45880 <sup>16</sup></p>  <p>HOOD INSULATION RETAINING CLIP</p> <p>10</p>	<p>45838 <sup>17</sup></p>  <p>SPLASH SHIELD &amp; FASCIA RETAINER</p> <p>15</p>	<p>45878 <sup>18</sup></p>  <p>PUSH TYPE RETAINER 1/4 HOLE</p> <p>10</p>
<p>45866 <sup>19</sup></p>  <p>PUSH TYPE RETAINER 8MM HOLE</p> <p>10</p>	<p>45864 <sup>20</sup></p>  <p>AIR BAFFLE TO UNDERCARRIAGE PUSH-TYPE RETAINER</p> <p>10</p>	<p>45430 <sup>21</sup></p>  <p>FASCIA RETAINER</p> <p>10</p>	<p>42100 <sup>22</sup></p>  <p>NYLON RADIATOR SHROUD RETAINER</p> <p>15</p>	<p>40090 <sup>23</sup></p>  <p>FRONT FENDER MUD SKIRT</p> <p>15</p>	<p><sup>24</sup></p> 

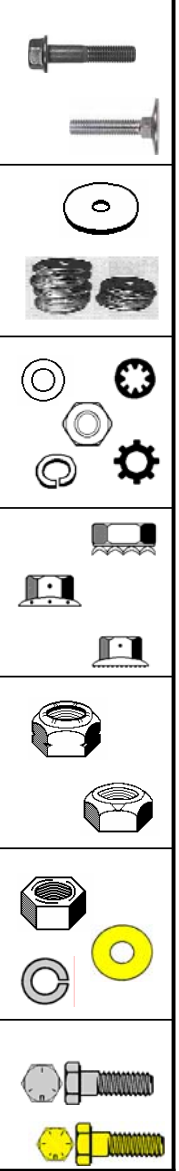



# J&B Fleet - Industrial Supply









22428 Harrisburg-Westville Rd. Alliance, Ohio 44601 Phone: (330) 821-6342 Fax: (330) 821-0411

[www.jbfleet.com](http://www.jbfleet.com)

PART # 2087

## HEAVY DUTY TUBE CLAMPS



<p>38728</p>  <p>5/8 (13/32 HOLE)</p>	<p>1</p> <p>2</p>	<p>3</p>
<p>38726</p>  <p>1/2 (13/32 HOLE)</p>	<p>4</p> <p>5</p> <p>13363</p>  <p>1" (13/32 HOLE)</p>	<p>6</p> <p>38732</p>  <p>1-1/2 (13/32 HOLE)</p>
<p>38724</p>  <p>3/8 (13/32 HOLE)</p>	<p>7</p> <p>8</p>	<p>9</p>
<p>38722</p>  <p>5/16 (13/32 HOLE)</p>	<p>10</p> <p>5</p> <p>38730</p>  <p>3/4 (13/32 HOLE)</p>	<p>12</p> <p>13364</p>  <p>1-1/4 (13/32 HOLE)</p>

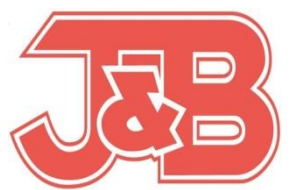
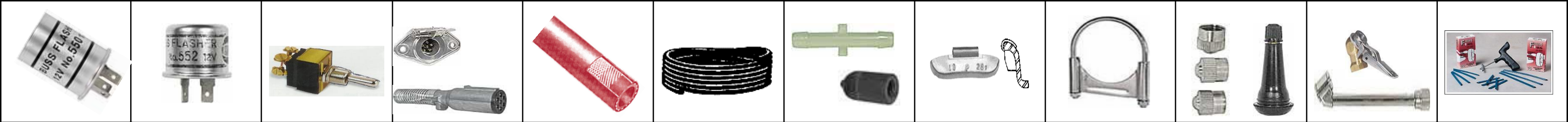







**PART#2827**

**J&B Fleet - Industrial Supply**

22428 Harrisburg-Westville Rd. Alliance, Ohio 44601 Phone: (330) 821-6342 Fax: (330) 821-0411

[www.jbfleet.com](http://www.jbfleet.com)

**LOOM CLAMPS - CARBON STEEL**

<p><b>45240</b></p>  <p><b>1/4"</b></p> <p>5</p>	<p><b>45243</b></p>  <p><b>5/8"</b></p> <p>4</p>	<p><b>45246</b></p>  <p><b>1"</b></p> <p>3</p>	<p><b>45250</b></p>  <p><b>1-1/2"</b></p> <p>2</p>
<p><b>45241</b></p>  <p><b>3/8"</b></p> <p>5</p>	<p><b>45244</b></p>  <p><b>3/4"</b></p> <p>4</p>	<p><b>45248</b></p>  <p><b>1-1/4"</b></p> <p>3</p>	



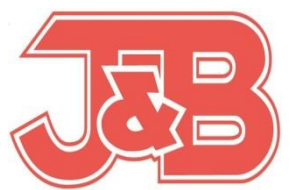
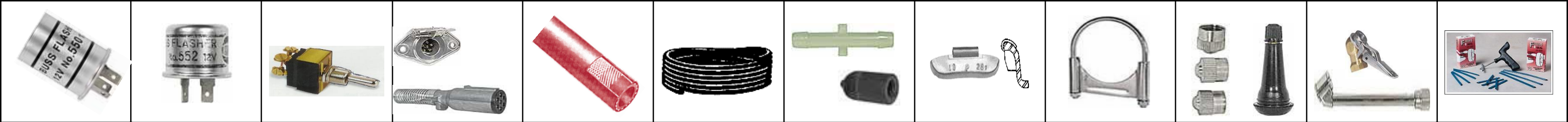

**PART# 2828**





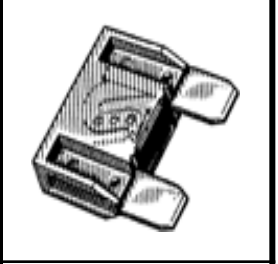

**J&B Fleet - Industrial Supply**

22428 Harrisburg-Westville Rd. Alliance, Ohio 44601 Phone: (330) 821-6342 Fax: (330) 821-0411

[www.jbfleet.com](http://www.jbfleet.com)

**LOOM CLAMPS – STAINLESS STEEL**



<p><b>45225</b></p>  <p><b>1/4"</b></p> <p>5</p>	<p><b>45228</b></p>  <p><b>5/8"</b></p> <p>4</p>	<p><b>45230</b></p>  <p><b>1"</b></p> <p>3</p>	<p><b>45234</b></p> 
<p><b>45226</b></p>  <p><b>3/8"</b></p> <p>5</p>	<p><b>45229</b></p>  <p><b>3/4"</b></p> <p>4</p>	<p><b>45232</b></p>  <p><b>1-1/4"</b></p> <p>3</p>	<p><b>1-1/2"</b></p> <p>2</p>





# J&B Fleet - Industrial Supply









22428 Harrisburg-Westville Rd. Alliance, Ohio 44601 Phone: (330) 821-6342 Fax: (330) 821-0411

[www.jbfleet.com](http://www.jbfleet.com)

PART # 2140

## UNIVERSAL SPRINGS



	<b>41350</b>	1
5	 <b>18 1/2" LONG 13/16" O.D. 3/32" WIRE</b>	
	<b>41351</b>	2
5	 <b>17 1/2" LONG 3/4" O.D. 1/16" WIRE</b>	
	<b>41353</b>	3
5	 <b>11 1/2" LONG 13/32" O.D. 1/32" WIRE</b>	
	<b>41354</b>	4
5	 <b>8 1/2" LONG 1 7/8" O.D. 3/32" WIRE</b>	
	<b>41356</b>	5
5	 <b>8 1/4" LONG 7/16" O.D. 1/16" WIRE</b>	
	<b>41359</b>	6
5	 <b>1 13/16" LONG 3/8" O.D. 1/32" WIRE</b>	
	<b>41360</b>	7
5	 <b>4 3/8" LONG 1/2" O.D. 1/16" WIRE</b>	
	<b>41357</b>	8
5	 <b>5 3/4" LONG 25/32" O.D. 3/64" WIRE</b>	