

REVIEW ON WIRELESS SENSOR NETWORK STABILITY DURING ROUTING APPROACHES

Kanwalharjot Kaur¹, Damandeep kaur²

^{1,2} *Electronics and Communication, Golden College of Engineering and Technology, INDIA*

Abstract- Routing plays a very challenging role in WSN technology. The WSN technology consists of the sensor nodes that are deployed densely either very close or within the sink and they have restricted memory, computational capacity, and power. Such kind of network is explained under the feature guidance at node as well as network level. The network is explained with variable position as well as fixed position scenarios. The location of nodes is explained under mobility guidance and narrow range setting under the implication of stability. The network is explained under the limitation of route identification and volume limit guidance. The network is explained under the node neighbor identification that can identify the efficient next hop to create the effective communication

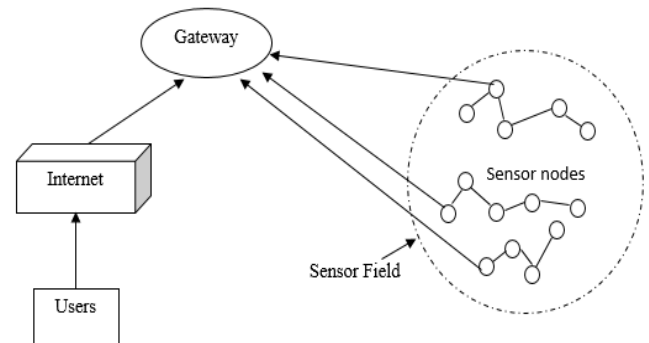

Figure 1.3 Components of WSN

Keywords: communication, WSN, routing, optimization

I. INTRODUCTION

There are three main components in WSN: nodes, gateways and software. Spatially distributed cluster heads interface with sensors to monitor assets. The collected data transmit to gateway wirelessly, and can operate independently. It is connected to a host system where the data can be collected, processed, analyzed and presented by using software. To extend WSN distance and reliability, special type of measurement node is used such as router node. WSN is a widely used system because of its low costs and high efficiency. WSN contains sensor nodes which basically utilized for detecting, imparting and information preparation. Sensor nodes can be utilized as a part of numerous fields like businesses, military, and farming applications, for example, transportation activity checking, natural observing, keen workplaces and front-line observations. In these applications, sensors are conveyed in a specially appointed way and work independently. In these unattended conditions, these sensors can't be effectively replaced or energized, and vitality utilization is the most basic issue that must be considered. The sensor is a small device which is used to detect the amount of physical parameters, event occurring, measures the presence of an object and then it converts the physical parameters to electrical signal values using electrical actuators.

1.3.3 Characteristics of WSN

The characteristics of WSN include the following:

- The consumption of power limits for nodes with batteries.
- Capacity to handle node failures.
- Heterogeneity of nodes and some mobility of nodes.
- Large scale distribution scalability.
- Ensure and maintaining strict environmental conditions.
- Cross-layer design.
- Simple/ Easy to use.

1.4 TYPES OF WSN TOPOLOGIES

The different types of network topology [4] are used for the development and deployment in wireless sensor network that are point to point, bus, star, tree, ring and mesh etc.

(a) Point to point network topology: This type of topology is used very commonly and it does not contain central hub part. Here, a sensor node can communicate with another node directly. It contains a single channel for data communication offering a secured path for communication. Each of the device works on a client-server mechanism.

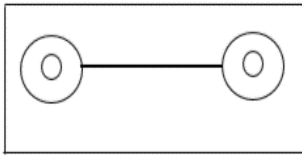

Figure 1.4 Point to Point Topology

(b) Bus Topology: In this topology the node sends the message to another node on the network and all nodes are able to see this message but only the actual recipient node accepts and processes the message. This topology is easy to install when the resources and nodes are in limited amount but the congestion is increased due to single path of communication.

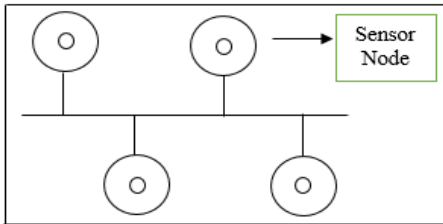

Figure 1.5 Bus Topology

(c) Star Topology: In this topology the sensor nodes are connected to the sink node and send the data through it. The direct communication of the nodes is not possible in this type of topology. The data sharing in this topology is easy due to a central communicator but if the sink node is fail then the whole network is not working and a condition of jamming is performed on network.

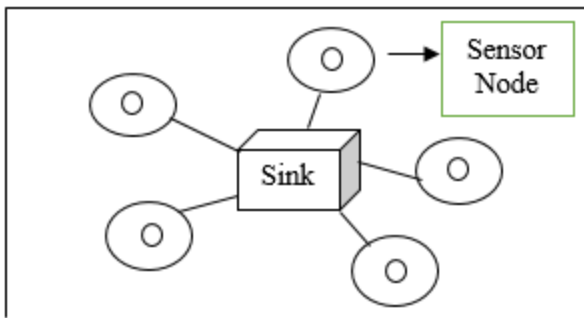

Figure 1.6 Star Topology

(e) Tree Topology: In the tree topology the central root node is worked as a router and selects the route for all the nodes. The central hub in this topology is just one level below the root node. The lower level of the topology is worked like a star topology and it is considered as hybrid. This topology worked as single and multi-hop and data is send by the central hub to the sink nodes.

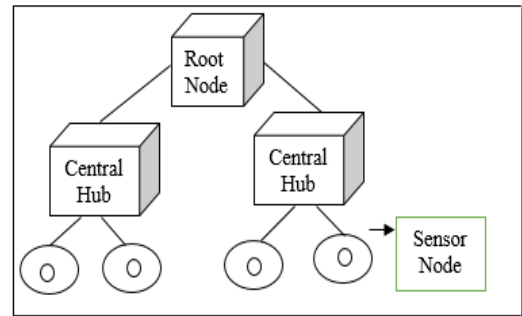

Figure 1.7 Tree Topology

(e) Ring Topology: In Ring topology each node has two neighbor nodes and the communication in ring topology is performed in always one direction. The direct communication between the nodes is not possible in this topology because all the nodes are connected through a loop. If the single node is failed in this network then the communication between the all nodes stops completely.

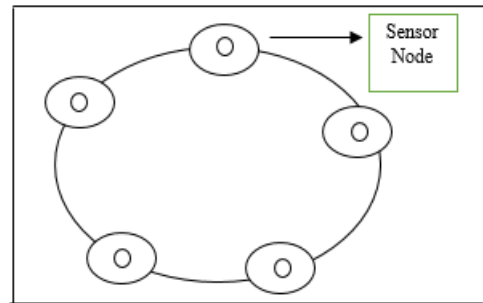

Figure 1.8 Ring Topology

(f) Mesh Topology

In mesh topology every node is connected to each other and able to share the data. Many paths are available between the sources and sink if the one path is failed due to some reasons then the communication does not affected and other path is taken by the nodes.

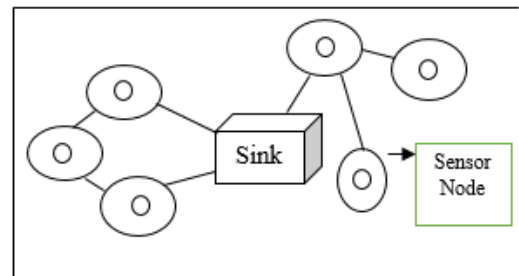

Figure 1.9 Mesh Topology

(g) **Circular Topology:** In circular topology [4, Figure.1.10] the sensing area is defined by the tiers in which sensing nodes and random nodes are deployed for the communication. The sink node is available at the center of the network. This topology is easy to maintain, easy to deploy and more efficient than other topologies.

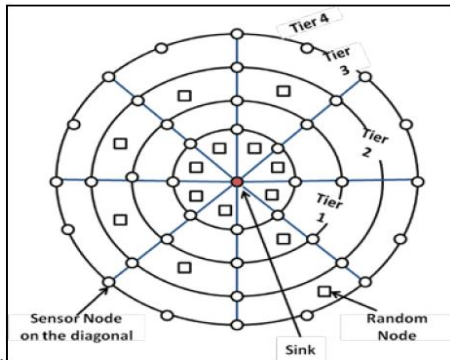

Figure 1.10 Circular Topology

(h) **Grid Topology:** In this topology [4, Figure 1.11] the network is divided into the equal sizes grids that are non-overlapped and square in shape. In each grid at least one node is working at the anytime. Each grid has a node head which is responsible for sending the information to the other node related to routing and data transmission. This topology is fast among all topologies and congestion is not possible in this topology due to the grids structure.

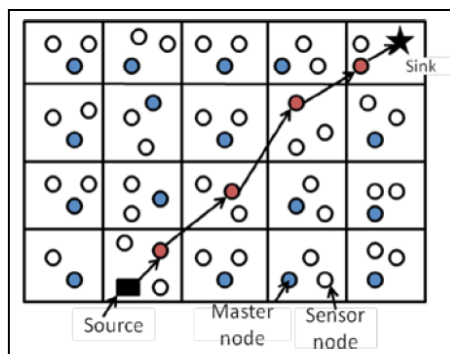

Figure 1.11 Grid Topology

II. RELATED WORK

Shelke, Maya et al. [1] proposed a congestion-aware routing protocol in the wireless sensor network. It works on the opportunistic theory and selects the optimized route. For scheduling on the network, it uses sleep mechanism. The proposed protocol reduced the congestion on the network and enhances the node's life and entire network life time. It also reduced the partitioning of the network. It mainly used to provide the appropriate path on the wireless network to the nodes.

Hong, Chao, et al. [2] introduced a Forwarding Area Division and Selection routing protocol in the wireless sensor network. This protocol used to classify the collisions in two forms that are same slot collision and distinct slot collision. It reduces the probability of same slot collision and it balances the load by using dynamic load balancing approach. Forwarding area division method is applicable on nodes within the same area and selecting sub area by reducing the number of candidates. This process reduced the same slot collision. Adaptive forwarding area selection is used to channelize the subarea dynamically. The simulation result of the proposed method reduced the packet delay, energy consumption.

Chincoli et al. [3] worked on the transmission power control in wireless sensor networks by using cognitive methods. In this protocols are divided into two types proactive and reactive. Cognitive protocols that are used this work are fuzzy logic, swarm intelligence and reinforcement learning. These protocols improve the energy level and quality of service management. This paper also gives information related to benefits of these protocols.

Umar, IdrisAbubakar, et al. [4] introduced the state free geographic forwarding protocol which worked on the concept of cross layering and combines the task of routing and media access control layers which minimizes the energy consumption. MAC protocols are able to mitigate the hidden terminal problem using handshake mechanism. This mechanism reduced the end-to-end delay and energy consumption in the wireless networks. In this work, the author uses Directional Compact Geographic Forwarding approach to reduce the excessive overhead in the multi-hop network. The result of the paper shows that it reduced the message overhead, energy consumption, and end-to-end delay.

Shafieirad et al. [5] proposed an energy-aware opportunistic routing protocol for wireless sensor networks. This protocol analyzed the energy available on the sensor node, distance from the other node and the amount of data transmission between the nodes. This protocol does not require any prior information related to the network topology. The experiment also tested by using the numerical results and it clearly shows that it enhanced the data delivery ratio.

Oh, Hoon et al. [6] introduced a slotted sense MAC protocol for timely and reliable data transfer in the wireless sensor network. This protocol allocates the sharable slot to each tree which produces topology independent schedule and makes it highly responsive. This protocol provides a reliable data transmission over the nodes. The sharable slot features the proposed method improve its performance by enhancing the data delivery ratio.

Agrawal, Deepika, et al. [7] Fuzzy based unequal clustering algorithm is proposed by the author in this article to enhance the lifetime of the wireless sensor network. It balanced the energy consumption by making the unequal clusters. Cluster heads are selected by using the fuzzy logic. Density, energy and base station distance are the input variables of the network. Rank and competition radius are the outputs of the fuzzy system. The performance of the proposed algorithm is compared with existing protocols and found that the proposed algorithm performs better.

Kirubakaran et al. [8] IW- MAC (invite and wait) protocol is proposed to provide efficient wireless sensor networks. This protocol is used to provide the efficient use of battery power by sensor nodes. It transfers the minimum control packets and maximum data packet in the given time. Energy on the nodes is used to transfer the data and reduce the overhead of control packets and channel reservation. This approach is used to save the energy during the data transmission on the nodes.

Gowtham et al. [9] proposed congestion control and packet recovery in cross-layer approach. It reduced the problem occurred by the traffic like congestion and contention on the data link layer and transport layer. This protocol recovers the missing packets by storing the copy of the data packets. To avoid the congestion on the network it assigns the priority to the nodes for transmitting data. On the basis of priority, the packets are transmitted to the next node. The packet which has the highest priority transmitted first and then next according to the assigned priority. The performance of the packet is tested on the simulator and gives effective results.

Swain et al. [10] work on the diagnosis of fault in the wireless network and proposed a protocol for it named as Heterogeneous Fault Diagnosis Protocol. This protocol consists of three phases that are clustering phase, fault detection phase, and fault classification phase. This method detects the faulty nodes and classification is done by using probabilistic neural network protocol. The simulation result of the proposed method is tested on NS-2 simulator.

Huang, Haojun, et al. [11] energy-efficient multicast geographic routing protocol (EMGR) is proposed by the author to provide the efficient and scalable wireless sensor network. It is a multicast tree which formed by the set of destination and the source node based on the energy. This protocol provides low energy consumption, computational overhead and high packet delivery ratio.

Kumberg, Timo, et al. [12] proposed a simple and effective cross-layer routing protocol called as T-ROME. In this nodes are containing wake up receivers. This by the protocol used to save energy skipping nodes during data transfer. In this

protocol, Markov chain model is also used for verification. This protocol enhanced the performance of the wireless sensor network.

Krishna et al. [13] uses sensor- media access control protocol and Leach to provide energy efficient wireless sensor network. In this method, Leach is used for adaptive clustering of the nodes in remote sensor systems. This method uses TDMA based MAC convention to adjust utilization. In these work different types of Leach is also used to enhance the performance.

Tan, Cheng Kiat, et al. [14] introduced FAEM data collection protocol which is used for energy efficient multicast multichannel routing in wireless sensor networks. It works on the basketball net topology in which it establishes a table for each node and also pre-assigns the channel which is different from the neighbor nodes. Time is divided into duty cycle and each cycle consists of two phases. The first phase called iterative scheduling phase and second phase called as slot-based packet forwarding phase. In this network tree upload nodes are called parent node and download nodes are called child node. Results of the proposed method give low energy consumption, low latency, and high data reliability.

Bahbahani, et al. [15] proposed cooperative clustering protocol to enhance the longevity of energy harvesting based WSN. It maintains the energy consumption between the cluster heads and nodes according to the duty cycle. In this TDMA approach is used with the cross-layer approach. Performance of the proposed system is analyzed by using parameters bandwidth utilization, latency, and energy consumption.

INFERENCE FROM THE LITERATURE SURVEY

Author's Name	Year	Algorithm Used	Effects on WSN
1) Shelke et al.	2018	Congestion-Aware Routing Protocol	The proposed protocol reduced the congestion on the network and enhances the node's life and entire network life time. It also reduced the partitioning of the network. It mainly used to provide the appropriate path on the wireless network to the nodes.
2) Hong et al.	2018	Forwarding Area Division And Selection	This process reduced the same slot collision. Adaptive forwarding area selection is used to channelize the subarea dynamically.
3) Chincholi et al.	2018	Proactive And Reactive. Cognitive Protocols	These protocols improve the energy level and quality of service management.
4) Umar et al.	2018	State Free Geographic Forwarding Protocol	Directional Compact Geographic Forwarding approach to reduce the excessive overhead in the multi-hop network. The result of the paper shows that it reduced the message overhead, energy consumption, and end-to-end delay.
5) Shafieirad, et al.	2018	Energy-Aware Opportunistic Routing Protocol	This protocol analyzed the energy available on the sensor node, distance from the other node and the amount of data transmission between the nodes. This protocol does not require any prior information related to the network topology and enhanced the data delivery ratio.
6) Oh. Hoon et al.	2018	Slotted Sense MAC Protocol	This protocol provides a reliable data transmission over the nodes. The sharable slot features the proposed method improve its performance by enhancing the data delivery ratio.
7) Agarwal et al.	2018	Fuzzy Based Unequal Clustering Algorithm	It balanced the energy consumption by making the unequal clusters. Cluster heads are selected by using the fuzzy logic.
8) Kirubakaran, et al.	2018	IW- MAC (Invite And Wait) Protocol	It transfers the minimum control packets and maximum data packet in the given time. Energy on the nodes is used to transfer the data and reduce the overhead of control packets and channel reservation. This approach is used to save the energy during the data transmission on the nodes.
9) Gautham et al.	2018	Cross-Layer Approach	This protocol recovers the missing packets by storing the copy of the data packets. To avoid the congestion on the network it assigns the priority to the nodes for transmitting data.
10) Swain, et al.	2018	Heterogeneous Fault Diagnosis Protocol	This method detects the faulty nodes and classification is done by using probabilistic neural network protocol.
11) Huang, et al.	2017	energy-efficient multicast geographic routing protocol (EMGR)	It is a multicast tree which shaped by the arrangement of destination and the source hub in view of the vitality. This convention gives low vitality utilization, computational overhead and high packet delivery ratio.

12) Kumberg Timo et al.	2017	T-Rome Routing Protocol	This by the protocol used to save energy skipping nodes during data transfer. In this protocol, Markov chain model is also used for verification.
13) Krishna et al	2017	TDMA and MAC	This method uses TDMA based MAC convention to adjust utilization. In these work different types of Leach is also used to enhance the performance.
14) Tang Cheng et al.	2017	FAEM Protocol	The proposed method gives low energy consumption, low latency, and high data reliability.
15) Bahbahani, et al.	2017	TDMA with Cross Layer Approach	It maintains the energy consumption between the cluster heads and nodes according to the duty cycle.
16) Saleh Ahmed et al.	2017	Multi-aware Query Driven routing protocol	This protocol focused on the life of the sensor, delay transmission of data and total cost of network and path on the network. Fuzzy rules are used to select the proper path.
17) Kulshrestha et al.	2017	Adaptive Energy Balanced And Energy Efficient Approach	Forwarding approach to reduce the excessive overhead in the multi-hop network. The result of the paper shows that it reduced the message overhead, energy consumption, and end-to-end delay.
18) Zhang, Xiaoying, et al.	2017	Mac Protocol	It checks the total power allocated to the senders to transmit data packets. This protocol gives congestion free network and nodes consuming low energy.
19) Bouachir, Ons, et al.	2017	EAMP-AIDC energy-aware protocol	Duty cycle considers the active and sleep periods of the nodes which are used for balancing of the nodes. This experiment is performed on OMNET++ and gives better energy consumption and enhanced the energy savings over the network.
20) Urard, Pascal, et al.	2017	Beaconless Geographic Routing	It uses two kind of handshake mechanism for delay sensitive packets that are request to send and clear to send.
21) Fouladlou, et al.	2017	EECA (Energy Efficient Clustering Algorithm)	In this work, clustering is done with the help of genetic algorithm for sake of effective routing and a long-lasting network lifetime. The performance evaluation of the proposed algorithm is done on the basis of parameters that are the end-to-end delay, energy consumption, bit error rate and throughput.

III CONCLUSION

information is sent through different nodes with an entryway and the information is conveyed to different networks like wireless Ethernet. These networks are utilized to control physical or ecological conditions like sound, weight, temperature and so forth. WSN nodes have constrained battery limit. As the use of WSN is increasing rapidly and simultaneously this technology is facing various major challenges of energy constraints depending upon the limited

lifetime of batteries as each of its node relies on energy demand for performing the basic operational activities which has become the major reason behind the failure in wireless sensor networks. One node interruption may result in shutting down the overall operation of the system. The nodal operation relies on active mode, idle, and sleeping modes. In case of active modes, energy is consumed while transmitting or receiving the data. In case of idle mode, the node consumes the energy same as consumed in active type node whereas in case of sleeping mode, the node gets shut down in order to save the energy.

IV REFERENCES

- [1] Shelke, Maya, Akshay Malhotra, and Parikshit N. Mahalle. "Congestion-Aware Opportunistic Routing Protocol in Wireless Sensor Networks." *Smart Computing and Informatics*. Springer, Singapore, 2018. 63-72.
- [2] Hong, Chao, et al. "FADS: Circular/Spherical Sector based Forwarding Area Division and Adaptive Forwarding Area Selection routing protocol in WSNs." *Ad Hoc Networks* 70 (2018): 121-134.
- [3] Chincoli, Michele, and Antonio Liotta. "Transmission power control in WSNs: from deterministic to cognitive methods." *Integration, Interconnection, and Interoperability of IoT Systems*. Springer, Cham, 2018. 39-57.
- [4] Umar, Idris Abubakar, et al. "Towards overhead mitigation in state-free geographic forwarding protocols for wireless sensor networks." *Wireless Networks* (2018): 1-14.
- [5] Shafieirad, Hossein, Raviraj S. Adve, and Shahram Shahbaz Panahi. "Max-SNR Opportunistic Routing for Large-Scale Energy Harvesting Sensor Networks." *IEEE Transactions on Green Communications and Networking* (2018).
- [6] Oh, Hoon, and Chi Trung Ngo. "A Slotted Sense Multiple Access Protocol for Timely and Reliable Data Transmission in Dynamic Wireless Sensor Networks." *IEEE Sensors Journal* (2018).
- [7] Agrawal, Deepika, and Sudhakar Pandey. "FUCA: Fuzzy-based unequal clustering algorithm to prolong the lifetime of wireless sensor networks." *International Journal of Communication Systems* 31.2 (2018).
- [8] Kirubakaran, M. K., and N. Sankararam. "IW-MAC: a invite and wait MAC protocol for power efficient wireless sensor networks." *Journal of Ambient Intelligence and Humanized Computing* (2018): 1-12.
- [9] Gowtham, M. S., and Kamalraj Subramaniam. "Congestion control and packet recovery for cross layer approach in MANET." *Cluster Computing* (2018): 1-8.
- [10] Swain, Rakesh Ranjan, Pabitra Mohan Khilar, and Sourav Kumar Bhoi. "Heterogeneous fault diagnosis for wireless sensor networks." *Ad Hoc Networks* 69 (2018): 15-37.
- [11] Huang, Haojun, et al. "EMGR: Energy-efficient multicast geographic routing in wireless sensor networks." *Computer Networks* 129 (2017): 51-63.
- [12] Kumberg, Timo, et al. "T-ROME: A simple and energy efficient tree routing protocol for low-power wake-up receivers." *Ad Hoc Networks* 59 (2017): 97-115.
- [13] Krishna, Konda Hari, Tapas Kumar, and Y. Suresh Babu. "Energy effectiveness practices in WSN over simulation and analysis of S-MAC and leach using the network simulator NS2." *I-SMAC (IoT in Social, Mobile, Analytics and Cloud)(I-SMAC), 2017 International Conference on*. IEEE, 2017.
- [14] Tan, Cheng Kiat, et al. "A fast, adaptive, and energy-efficient multi-path-multi-channel data collection protocol for wireless sensor networks." *Recent Advances in Signal Processing, Telecommunications & Computing (SigTelCom), International Conference on*. IEEE, 2017.
- [15] Bahbahani, Mohammed, and Emad Alsusa. "A Cooperative Clustering Protocol With Duty Cycling for Energy Harvesting Enabled Wireless Sensor Networks." *IEEE Transactions on Wireless Communications* (2017).
- [16] Saleh, Ahmed I., Khaled M. Abo-Al-Ez, and Ahmed A. Abdullah. "A Multi-Aware Query Driven (MAQD) routing protocol for mobile wireless sensor networks based on neuro-fuzzy inference." *Journal of Network and Computer Applications* 88 (2017): 72-98.
- [17] Sen, GB Zionna, and GG Zionar Sen. "An energy efficient for WSN using mobile co-ordinator in fuzzy method." *Information Communication and Embedded Systems (ICICES), 2017 International Conference on*. IEEE, 2017.
- [18] Kulshrestha, J., and M. K. Mishra. "An adaptive energy balanced and energy efficient approach for data gathering in wireless sensor networks." *Ad Hoc Networks* 54 (2017): 130-146.
- [19] Zhang, Xiaoying, et al. "Performance of energy-efficient cooperative MAC protocol with power backoff in MANETs." *Wireless Personal Communications* 92.3 (2017): 843-861.
- [20] Bouachir, Ons, et al. "EAMP-AIDC-energy-aware mac protocol with adaptive individual duty cycle for EH-WSN." *Wireless Communications and Mobile Computing Conference (IWCMC), 2017 13th International*. IEEE, 2017.
- [21] Hong, Chao, Zhongyang Xiong, and Yufang Zhang. "A hybrid beaconless geographic routing for different packets in WSN." *Wireless Networks* 22.4 (2016): 1107-1120.