

COTTER PINS

Zinc Plated

- One prong is extended for easy insertion.
- Use to lock clevis pins, slotted nuts, and other fasteners.

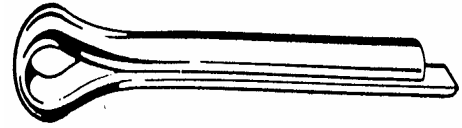

| 1/16 DIAMETER | | |
|---------------|--------------|-----|
| J&B # | SIZE | QTY |
| 12330 | 1/16 x 1/2 | 100 |
| 12331 | 1/16 x 3/4 | 100 |
| 12332 | 1/16 x 1 | 100 |
| 12333 | 1/16 x 1-1/4 | 100 |
| 12334 | 1/16 x 1-1/2 | 100 |
| 12335 | 1/16 x 1-3/4 | 100 |
| 12336 | 1/16 x 2 | 100 |

| 5/64 DIAMETER | | |
|---------------|----------|-----|
| J&B # | SIZE | QTY |
| 12325 | 5/64 x 1 | 100 |
| 12327 | 5/64 x 2 | 100 |

| 7/64 DIAMETER | | |
|---------------|----------|-----|
| J&B # | SIZE | QTY |
| 12328 | 7/64 x 1 | 100 |
| 12329 | 7/64 x 2 | 100 |

| 3/32 DIAMETER | | |
|---------------|--------------|-----|
| J&B # | SIZE | QTY |
| 12337 | 3/32 x 1/2 | 100 |
| 12338 | 3/32 x 3/4 | 100 |
| 12339 | 3/32 x 1 | 100 |
| 12340 | 3/32 x 1-1/4 | 100 |
| 12341 | 3/32 x 1-1/2 | 100 |
| 12342 | 3/32 x 1-3/4 | 100 |
| 12343 | 3/32 x 2 | 100 |
| 12345 | 3/32 x 2-1/2 | 100 |

| 5/32 DIAMETER | | |
|---------------|--------------|-----|
| J&B # | SIZE | QTY |
| 12356 | 5/32 x 3/4 | 100 |
| 12357 | 5/32 x 1 | 100 |
| 12358 | 5/32 x 1-1/4 | 100 |
| 12359 | 5/32 x 1-1/2 | 100 |
| 12361 | 5/32 x 2 | 100 |
| 12363 | 5/32 x 2-1/2 | 100 |
| 12364 | 5/32 x 3 | 100 |

| 1/8 DIAMETER | | |
|--------------|-------------|-----|
| J&B # | SIZE | QTY |
| 12346 | 1/8 x 1/2 | 100 |
| 12347 | 1/8 x 3/4 | 100 |
| 12348 | 1/8 x 1 | 100 |
| 12349 | 1/8 x 1-1/4 | 100 |
| 12350 | 1/8 x 1-1/2 | 100 |
| 12351 | 1/8 x 1-3/4 | 100 |
| 12352 | 1/8 x 2 | 100 |
| 12353 | 1/8 x 2-1/4 | 100 |
| 12354 | 1/8 x 2-1/2 | 100 |
| 12355 | 1/8 x 3 | 100 |

COTTER PINS

Zinc Plated

- One prong is extended for easy insertion.
- Use to lock clevis pins, slotted nuts, and other fasteners.

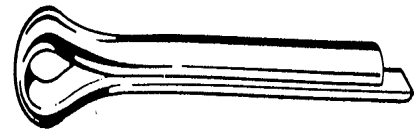

| 3/16 DIAMETER | | |
|---------------|--------------|-----|
| J&B # | SIZE | QTY |
| 12365 | 3/16 x 3/4 | 100 |
| 12366 | 3/16 x 1 | 100 |
| 12367 | 3/16 x 1-1/4 | 100 |
| 12368 | 3/16 x 1-1/2 | 100 |
| 12369 | 3/16 x 1-3/4 | 100 |
| 12370 | 3/16 x 2 | 100 |
| 12371 | 3/16 x 2-1/4 | 100 |
| 12372 | 3/16 x 2-1/2 | 100 |
| 12373 | 3/16 x 3 | 100 |
| 25149 | 3/16 x 4 | 50 |

| 1/4 DIAMETER | | |
|--------------|-------------|-----|
| J&B # | SIZE | QTY |
| 12374 | 1/4 x 1 | 50 |
| 12375 | 1/4 x 1-1/4 | 50 |
| 12376 | 1/4 x 1-1/2 | 50 |
| 12377 | 1/4 x 1-3/4 | 50 |
| 12378 | 1/4 x 2 | 50 |
| 12380 | 1/4 x 2-1/2 | 50 |
| 12381 | 1/4 x 3 | 50 |
| 12382 | 1/4 x 3-1/2 | 50 |
| 12383 | 1/4 x 4 | 50 |
| 12931 | 1/4 x 6 | 25 |

| 5/16 DIAMETER | | |
|---------------|--------------|-----|
| J&B # | SIZE | QTY |
| 12384 | 5/16 x 1 | 50 |
| 12385 | 5/16 x 1-1/2 | 50 |
| 12386 | 5/16 x 2 | 50 |
| 12388 | 5/16 x 3 | 25 |
| 12390 | 5/16 x 4 | 25 |
| 12932 | 5/16 x 6 | 25 |

| 3/8 DIAMETER | | |
|--------------|-------------|-----|
| J&B # | SIZE | QTY |
| 12392 | 3/8 x 2 | 25 |
| 12393 | 3/8 x 3 | 25 |
| 12394 | 3/8 x 3-1/2 | 25 |
| 12395 | 3/8 x 4 | 25 |
| 12933 | 3/8 x 6 | 25 |

| 1/2 DIAMETER | | |
|--------------|---------|-----|
| J&B # | SIZE | QTY |
| 12396 | 1/2 x 3 | 25 |
| 12397 | 1/2 x 4 | 25 |
| 20084 | 1/2 x 6 | 25 |

| 5/8 DIAMETER | | |
|--------------|---------|-----|
| J&B # | SIZE | QTY |
| * 12399 | 5/8 x 6 | 25 |

* Unplated

SPRING LOCK PINS

Zinc Plated

- Chamfered ends for easier starting.
- Carbon steel construction for superior strength.
- Tap in and pin expands to grip tightly.



| 1/16 DIAMETER | | |
|---------------|--------|-----|
| J&B # | LENGTH | QTY |
| 12401 | 1/4 | 50 |
| 12406 | 3/8 | 50 |
| 12400 | 1/2 | 50 |
| 12402 | 3/4 | 50 |
| 12487 | 1 | 50 |

| 5/64 DIAMETER | | |
|---------------|--------|-----|
| J&B # | LENGTH | QTY |
| 12403 | 1/4 | 50 |
| 12405 | 1/2 | 50 |
| 12413 | 5/8 | 50 |
| 12407 | 3/4 | 50 |
| 12412 | 1 | 50 |

| 3/32 DIAMETER | | |
|---------------|--------|-----|
| J&B # | LENGTH | QTY |
| 12410 | 1/2 | 50 |
| 12411 | 3/4 | 50 |
| 12414 | 1 | 50 |
| 12485 | 1-1/2 | 50 |

| 1/8 DIAMETER | | |
|--------------|--------|-----|
| J&B # | LENGTH | QTY |
| 12415 | 3/8 | 50 |
| 12416 | 1/2 | 50 |
| 12417 | 5/8 | 50 |
| 12418 | 3/4 | 50 |
| 12420 | 1 | 50 |
| 12421 | 1-1/4 | 50 |
| 12422 | 1-1/2 | 50 |
| 25166 | 1-3/4 | 25 |
| 32086 | 2 | 25 |

| 5/32 DIAMETER | | |
|---------------|--------|-----|
| J&B # | LENGTH | QTY |
| 12423 | 1/2 | 50 |
| 12425 | 3/4 | 50 |
| 12426 | 1 | 50 |
| 12427 | 1-1/4 | 50 |
| 12428 | 1-1/2 | 25 |

| 3/16 DIAMETER | | |
|---------------|--------|-----|
| J&B # | LENGTH | QTY |
| 12429 | 1/2 | 50 |
| 12431 | 3/4 | 50 |
| 12432 | 1 | 25 |
| 12433 | 1-1/4 | 25 |
| 12434 | 1-1/2 | 25 |
| 12435 | 1-3/4 | 25 |
| 12436 | 2 | 25 |

SPRING LOCK PINS

Zinc Plated

- Chamfered ends for easier starting.
- Carbon steel construction for superior strength.
- Tap in and pin expands to grip tightly.



| 7/32 DIAMETER | | |
|---------------|--------|-----|
| J&B # | LENGTH | QTY |
| 12437 | 3/4 | 25 |
| 12438 | 1 | 25 |
| 12439 | 1-1/4 | 25 |
| 12440 | 1-1/2 | 25 |
| 12484 | 1-3/4 | 50 |
| 12442 | 2 | 25 |

| 1/4 DIAMETER | | |
|--------------|--------|-----|
| J&B # | LENGTH | QTY |
| 25170 | 5/8 | 50 |
| 12443 | 3/4 | 50 |
| 12444 | 1 | 25 |
| 12445 | 1-1/4 | 25 |
| 12447 | 1-1/2 | 25 |
| 12446 | 1-3/4 | 25 |
| 12448 | 2 | 25 |
| 12486 | 2-1/4 | 25 |
| 12450 | 2-1/2 | 25 |
| 12452 | 3 | 25 |

| 5/16 DIAMETER | | |
|---------------|--------|-----|
| J&B # | LENGTH | QTY |
| 32085 | 3/4 | 25 |
| 12466 | 1 | 25 |
| 12468 | 1-1/2 | 25 |
| 12470 | 2 | 25 |
| 12472 | 2-1/2 | 20 |

| 3/8 DIAMETER | | |
|--------------|--------|-----|
| J&B # | LENGTH | QTY |
| 12453 | 1 | 25 |
| 12455 | 1-1/2 | 25 |
| 12457 | 2 | 25 |
| 12459 | 2-1/2 | 20 |
| 12461 | 3 | 15 |

| 7/16 DIAMETER | | |
|---------------|--------|-----|
| J&B # | LENGTH | QTY |
| 12481 | 1-1/2 | 20 |

| 1/2 DIAMETER | | |
|--------------|--------|-----|
| J&B # | LENGTH | QTY |
| 25171 | 1-1/4 | 10 |
| 12482 | 1-1/2 | 10 |
| 25172 | 2 | 10 |
| 12483 | 3 | 10 |
| 25173 | 4 | 10 |

HITCH PIN CLIPS / HAIRPINS

ZINC PLATED

Also known as: Bridge Pins, R-Keys, R-Clips or Presto Pins
(Pictures Actual Size)

- Easily inserted and quickly removed.
- Universal usage such as on shafts, wheels, small engines, to hold washers in place.



J&B #13264



J&B #13266



J&B #13268



J&B #13270

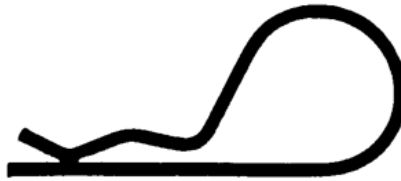

J&B #13272



J&B #13274



J&B #13276



J&B #13254

| J&B # | DRILL HOLE SIZE | WIRE DIA. | OVERALL LENGTH | INSIDE EYE DIA. | QTY |
|-------|-----------------|-----------|----------------|-----------------|-----|
| 13264 | 1/32 | .028 | .600 | .093 | 100 |
| 13266 | 3/64 | .042 | 1 | 1/4 | 100 |
| 13268 | 1/16 | .047 | 1-9/16 | 5/16 | 100 |
| 13270 | 5/64 | .062 | 1-9/16 | 3/8 | 100 |
| 13272 | 5/64 | .072 | 1-7/8 | 5/8 | 100 |
| 13274 | 3/32 | .080 | 1-9/16 | 3/8 | 100 |
| 13276 | 7/64 | .093 | 1-5/8 | 3/8 | 50 |
| 13254 | 7/64 | .093 | 2-5/16 | 5/8 | 50 |

HITCH PIN CLIPS / HAIRPINS

ZINC PLATED

Also known as: Bridge Pins, R-Keys, R-Clips or Presto Pins
(Pictures Actual Size)



J&B #13278



J&B #13262



J&B #13256



J&B #13280



J&B #13282

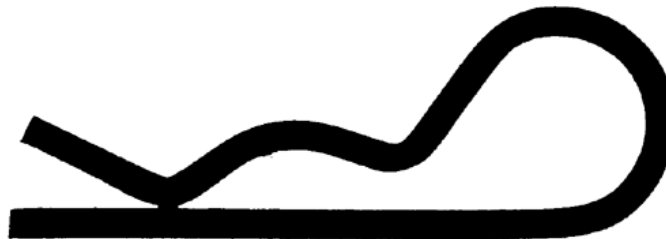

J&B #13260

| J&B # | DRILL HOLE SIZE | WIRE DIA. | OVERALL LENGTH | INSIDE EYE DIA. | QTY |
|-------|-----------------|-----------|----------------|-----------------|-----|
| 13278 | 1/8 | .105 | 1-1/4 | 1/8 | 50 |
| 13262 | 9/64 | .125 | 1-15/16 | 7/16 | 50 |
| 13256 | 9/64 | .125 | 2-1/2 | 5/8 | 25 |
| 13280 | 9/64 | .125 | 2-7/8 | 5/8 | 25 |
| 13282 | 5/32 | .148 | 2-15/16 | 3/4 | 25 |
| 13260 | 3/16 | .177 | 3-3/4 | 15/16 | 10 |

WOODRUFF KEYS

- Low-carbon steel.
- Smooth finish for easy insertion.
- Ideal for machine repair.



| J&B # | IND. # | T L | H | QTY |
|-------|--------|--------------|-------|-----|
| 12586 | # 2 | 3/32 x 1/2 | 3/16 | 25 |
| 12587 | # 4 | 3/32 x 5/8 | 1/4 | 25 |
| 12588 | # 3 | 1/8 x 1/2 | 3/16 | 25 |
| 12589 | # 5 | 1/8 x 5/8 | 1/4 | 25 |
| 12590 | # 6 | 5/32 x 5/8 | 1/4 | 25 |
| 12591 | # 8 | 5/32 x 3/4 | 19/64 | 25 |
| 12592 | #10 | 5/32 x 7/8 | 23/64 | 20 |
| 12593 | # 9 | 3/16 x 3/4 | 19/64 | 25 |
| 12594 | #11 | 3/16 x 7/8 | 23/64 | 20 |
| 12595 | #13 | 3/16 x 1 | 27/64 | 20 |
| 12596 | #91 | 1/4 x 3/4 | 19/64 | 20 |
| 12597 | # A | 1/4 x 7/8 | 23/64 | 20 |
| 12598 | #15 | 1/4 x 1 | 15/32 | 15 |
| 12599 | #18 | 1/4 x 1-1/8 | 27/64 | 10 |
| 12600 | #21 | 1/4 x 1-1/4 | 17/32 | 10 |
| 12601 | # B | 5/16 x 1 | 27/64 | 10 |
| 12602 | # C | 5/16 x 1-1/8 | 15/32 | 10 |
| 12603 | # D | 5/16 x 1-1/4 | 17/32 | 10 |
| 12604 | #152 | 3/8 x 1 | 27/64 | 10 |
| 12605 | # E | 3/8 x 1-1/4 | 17/32 | 10 |

WIRE ROPE

WIRE ROPE CLIPS

Zinc Plated

- Hot dip galvanized; malleable iron.
- Accurately formed wire rope channels on saddle eliminates damage to cable.



| J&B # | SIZE | QTY |
|-------|------|-----|
| 13223 | 1/8 | 10 |
| 13224 | 3/16 | 10 |
| 13226 | 1/4 | 10 |
| 13227 | 5/16 | 10 |
| 13228 | 3/8 | 10 |
| 13230 | 1/2 | 10 |
| 13232 | 5/8 | 5 |
| 13233 | 3/4 | 5 |

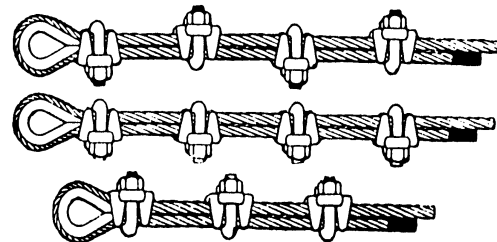

To give adequate holding force, U-bolt clips must be spaced along the rope at equal intervals. . . usually at a distance of six wire-rope diameters. Before the rope is placed under tension, the nuts are tightened. But after the load is applied to the rope, the nuts must be tightened again.

THIMBLES

- Carbon steel; hot galvanized.
- Recommended for light duty service.

| J&B # | SIZE (ROPE DIA.) | APPROX. LENGTH OVERALL | MIN. INSIDE WIDTH | QTY |
|-------|---------------------|------------------------------|-------------------------|-----|
| 41490 | 1/8 | 1-3/4 | 11/16 | 10 |
| 41491 | 3/16 | 1-3/4 | 11/16 | 10 |
| 41492 | 1/4 | 1-7/8 | 11/16 | 10 |
| 41493 | 5/16 | 2 | 13/16 | 10 |
| 41494 | 3/8 | 2-1/2 | 25/32 | 10 |
| 41496 | 1/2 | 3 | 1-1/8 | 10 |



OVAL CABLE SLEEVES

| J&B # | SIZE | QTY |
|--------|------|-----|
| V56990 | 1/8 | 50 |
| V56991 | 3/16 | 50 |
| 56992 | 1/4 | 10 |



LINKAGE HARDWARE

ANCHOR SHACKLES

With Screw Pin

- Zinc plated.
- GR30.



| J&B # | SIZE | PIN DIAMETER | WORKING LOAD LIMIT | QTY |
|-------|------|--------------|--------------------|-----|
| 41527 | 1/4 | 5/16 | 400 LB | 5 |
| 41521 | 5/16 | 3/8 | 700 LB | 5 |
| 41522 | 3/8 | 7/16 | 1000 LB | 5 |
| 41523 | 1/2 | 1/2 | 2000 LB | 5 |
| 41524 | 5/8 | 5/8 | 3000 LB | 5 |
| 41525 | 3/4 | 3/4 | 4000 LB | 5 |

SWIVEL SAFETY HASP

- Zinc plated.



| J&B # | SIZE | QTY |
|--------|--------|-----|
| V56985 | 4-1/2" | EA |

LINKAGE HARDWARE

SNAP SAFETY PINS

- Quick connect and disconnect offers thousands of applications on equipment, shafts and trailers.
- Headed shank formed of 1010 carbon steel, retainer wire formed of MB spring steel.
- Two Wire; zinc plated for corrosion resistance.



Square Handle

Round Handle

| J&B # | NOMINAL (D) | EFFECTIVE LENGTH (EL) | SHANK LENGTH (SL) | WIRE CLEARANCE (W) | WIRE DIA. (T) | HANDLE STYLE | QTY |
|-------|-------------|-----------------------|-------------------|--------------------|---------------|--------------|-----|
| 41055 | 1/4 | 1-3/8 | 1-5/8 | 1.625 | .091 | Round | 5 |
| 41054 | 1/4 | 2-1/4 | 2-1/2 | 1.625 | .091 | Square | 5 |
| 39225 | 1/4 | 2-1/2 | 2-3/4 | 1.625 | .091 | Square | 5 |
| 39226 | 5/16 | 1-3/8 | 1-5/8 | 1.75 | .091 | Round | 5 |
| 41056 | 5/16 | 2-1/4 | 2-1/2 | 1.75 | .091 | Square | 5 |
| 39227 | 5/16 | 2-1/2 | 2-3/4 | 1.75 | .091 | Square | 5 |
| 39228 | 5/16 | 3 | 3-1/4 | 1.75 | .091 | Square | 5 |
| 39229 | 3/8 | 1-1/2 | 1-3/4 | 1.50 | .091 | Round | 5 |
| 41061 | 3/8 | 2-1/4 | 2-1/2 | 1.50 | .091 | Square | 5 |
| 39230 | 3/8 | 2-1/2 | 2-3/4 | 1.50 | .091 | Square | 5 |
| 39231 | 3/8 | 3 | 3-1/4 | 1.50 | .091 | Square | 5 |

HITCH PINS

- Red plastisol coated head, heavy duty, made of high tensile strength and heat treated.
- Includes hairpin.

| J&B # | SHAFT DIAMETER | USEABLE LENGTH | QTY |
|-------|----------------|----------------|-----|
| 41483 | 3/8 | 4" | 6 |
| 41484 | 1/2 | 3-5/8" | 6 |
| 41485 | 5/8 | 5-1/2" | 6 |
| 41486 | 3/4 | 6-1/2" | 6 |

LINKAGE HARDWARE

LYNCH PINS

- Forged, gold dichromate plating.
- Quick disconnect fastener.

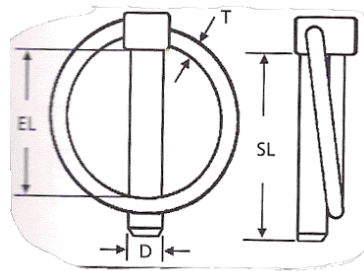

| J&B # | NOMINAL (D) | EFFECTIVE LENGTH (EL) | SHANK LENGTH (SL) | WIRE DIAMETER (T) | QTY |
|--------|-------------|-----------------------|-------------------|-------------------|-----|
| 41057 | 3/16 | 1" | 1-1/4 | .118 | 10 |
| 41062 | 3/16 | 1-1/4 | 1-9/16 | .138 | 10 |
| 39232 | 3/16 | 1-3/4 | 2 | .138 | 10 |
| 41063 | 1/4 | 1-1/4 | 1-9/16 | .138 | 10 |
| 41059 | 1/4 | 1-5/16 | 1-3/4 | .138 | 10 |
| 41079 | 1/4 | 1-3/4 | 2 | .138 | 10 |
| 41066 | 5/16 | 1-1/4 | 1-9/19 | .138 | 10 |
| 41064 | 5/16 | 1-3/8 | 1-3/4 | .138 | 10 |
| 41080 | 5/16 | 1-3/4 | 2 | .138 | 10 |
| 41060 | 7/16 | 1-5/8 | 1-15/16 | .138 | 10 |
| *41065 | 7/16 | 1-3/4 | 2-1/4 | .177 | 10 |
| 41081 | 7/16 | 2-1/4 | 2-1/2 | .177 | 10 |

*plain

BOLT SNAP

- Swiveling round eye. Polished solid bronze.



| J&B # | SIZE | DESCRIPTION | OPENING | QTY |
|--------|--------|----------------------|---------|-----|
| R51339 | 3-5/32 | 3/4 Round swivel eye | 3/8 | EA |

SNAP LINK

- Malleable iron with zinc finish.

| J&B # | SIZE | QTY |
|-------|------|-----|
| 41050 | 1/4 | 10 |
| 41051 | 5/16 | 10 |
| 41052 | 3/8 | 10 |
| 41044 | 7/16 | 10 |
| 41045 | 1/2 | 10 |
| 41047 | 5/8 | 10 |



LINKAGE HARDWARE

CLEVIS GRAB HOOKS

Grade 43



Grade 70



WORKING LOAD LIMIT MUST NOT BE EXCEEDED

- Forged Steel. Zinc plated finish
- Forged Steel. Yellow chromate finish
- Transport Grade

| J&B # | CHAIN SIZE | WORKING LOAD LIMIT - LBS. | QTY |
|-------|------------|---------------------------|-----|
| 38710 | 1/4 | 2,600 | EA |
| 38711 | 5/16 | 3,900 | EA |
| 38712 | 3/8 | 5,400 | EA |

| J&B # | CHAIN SIZE | WORKING LOAD LIMIT - LBS. | QTY |
|-------|------------|---------------------------|-----|
| 57038 | 1/4 | 3,150 | EA |
| 57039 | 5/16 | 4,700 | EA |
| 57046 | 3/8 | 6,600 | EA |
| 38713 | 1/2 | 11,300 | EA |

CLEVIS SLIP HOOKS

Grade 43

- Forged Steel. Zinc plated finish.

| J&B # | CHAIN SIZE | WORKING LOAD LIMIT - LBS. | QTY |
|--------|------------|---------------------------|-----|
| R52058 | 1/4 | 2,600 | EA |
| R52059 | 5/16 | 3,900 | EA |
| R52060 | 3/8 | 5,400 | EA |



5/16 & 3/8 with latch



1/4 without latch

LINKAGE HARDWARE

UNIVERSAL CLEVIS PINS

Zinc Plated

| J&B # | SIZE | QTY |
|-------|----------|-----|
| 13185 | 1/4 x 2 | 10 |
| 13186 | 5/16 x 2 | 10 |
| 13187 | 3/8 x 2 | 10 |
| 13188 | 7/16 x 2 | 10 |
| 13189 | 1/2 x 2 | 10 |
| 38960 | 5/8 x 3 | 5 |
| 38961 | 3/4 x 3 | 5 |



* Length is under the head to the end of pin.

STANDARD CLEVIS PINS

Zinc Plated



* Length is under the head to the end of pin.

| J&B # | SIZE | QTY |
|-------|--------------|-----|
| 37480 | 3/16 x 1/2 | 10 |
| 37481 | 3/16 x 3/4 | 10 |
| 37482 | 3/16 x 1 | 10 |
| 37483 | 3/16 x 1-1/2 | 10 |

| J&B # | SIZE | QTY |
|-------|-------------|-----|
| 37486 | 1/4 x 3/4 | 10 |
| 37500 | 1/4 x 1 | 10 |
| 37501 | 1/4 x 1-1/4 | 10 |
| 37502 | 1/4 x 1-1/2 | 10 |
| 37450 | 1/4 x 1-3/4 | 10 |
| 37451 | 1/4 x 2 | 10 |

| J&B # | SIZE | QTY |
|-------|--------------|-----|
| 37506 | 5/16 x 1 | 10 |
| 37507 | 5/16 x 1-1/4 | 10 |
| 37508 | 5/16 x 1-1/2 | 10 |
| 37456 | 5/16 x 1-3/4 | 10 |
| 37457 | 5/16 x 2 | 10 |

| J&B # | SIZE | QTY |
|-------|---------|-----|
| 37525 | 5/8 x 2 | 10 |
| 37526 | 5/8 x 3 | 10 |

| J&B # | SIZE | QTY |
|-------|-------------|-----|
| 37512 | 3/8 x 1 | 10 |
| 37513 | 3/8 x 1-1/4 | 10 |
| 37514 | 3/8 x 1-1/2 | 10 |
| 37462 | 3/8 x 1-3/4 | 10 |
| 37463 | 3/8 x 2 | 10 |
| 37464 | 3/8 x 2-1/4 | 10 |
| 37465 | 3/8 x 2-1/2 | 10 |

| J&B # | SIZE | QTY |
|-------|--------------|-----|
| 37490 | 7/16 x 1-1/4 | 10 |
| 37524 | 7/16 x 1-1/2 | 10 |
| 37469 | 7/16 x 2 | 10 |
| 37470 | 7/16 x 2-1/2 | 10 |

| J&B # | SIZE | QTY |
|-------|-------------|-----|
| 40505 | 1/2 x 1-1/2 | 10 |
| 37473 | 1/2 x 1-3/4 | 10 |
| 37474 | 1/2 x 2 | 10 |
| 37475 | 1/2 x 2-1/4 | 10 |
| 37498 | 1/2 x 2-1/2 | 10 |
| 37499 | 1/2 x 3 | 10 |

| J&B # | SIZE | QTY |
|-------|---------|-----|
| 39031 | 3/4 x 3 | 5 |

BRAKE CHAMBER YOKE

| J&B # | DESCRIPTION | QTY |
|-------|--|-----|
| 40500 | 5/8-18 NF Thread 1 29/32" Length 1/2" Pin Hole | 10 |



* Use Clevis pin 40505 for brake chamber yoke

CHAIN HARDWARE

DOUBLE CLEVIS LINKS

- Designed for linking all popular sizes of chain to rings, end links, eye hooks, pad eyes, tractor eyebolts, etc.
- Pin can be removed with pliers or screwdriver.
- All pins alloy steel, quenched and tempered.

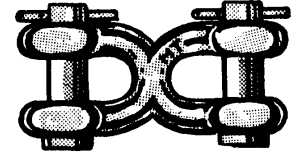

| J&B # | SIZE | COLOR | WORK LOAD LIMIT | QTY |
|-------|------|-------------|-----------------|-----|
| 41502 | 1/4 | BLUE CHROME | 3,900 | 2 |
| 41406 | 3/8 | ZINC | 5,400 | 5 |

COLD SHUTS

- Zinc plated.

| J&B # | SIZE OF CHAIN | WORK LOAD LIMIT | QTY |
|-------|---------------|-----------------|-----|
| 41518 | 1/4 | 800 | 10 |
| 41519 | 5/16 | 1,300 | 10 |
| 41520 | 3/8 | 1,900 | 10 |

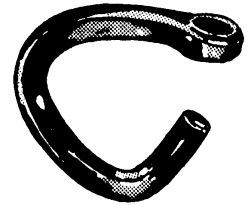

QUICK LINK

- Beveled hex nut. Steel with zinc finish.

| J&B # | SIZE | WORK LOAD LIMIT | QTY |
|--------|------|-----------------|-----|
| R79101 | 1/8 | 220 LBS | EA |
| R52622 | 3/16 | 660 LBS | EA |
| R52623 | 1/4 | 880 LBS | EA |
| R52624 | 5/16 | 1,760 LBS | EA |
| R52625 | 3/8 | 2,200 LBS | EA |
| R52604 | 1/2 | 3,300 LBS | EA |

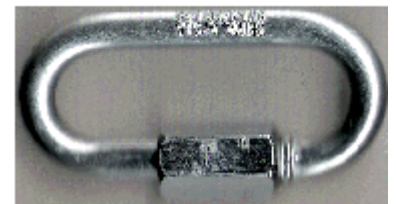

CHAIN

ASA STANDARD ROLLER CHAIN

- For chain drive power transmission.
- The finest quality imported roller chain with longer wear life and higher resistance to fatigue.
- Connecting parts are made to American standard specifications.
- One connecting link furnished.

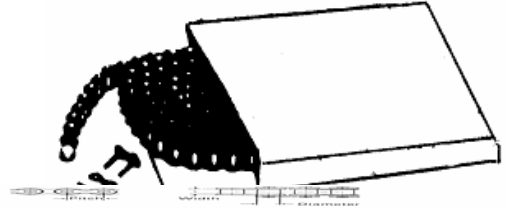

| ASA NO. | J&B # | PITCH IN INCHES | ROLLER IN INCHES | | TENSILE STRENGTH | QTY |
|---------|-------|-----------------|------------------|----------|------------------|--------|
| | | | WIDTH | DIAMETER | | |
| 40 | 38944 | 1/2 | 5/16 | .156 | 3700 | 10 FT. |
| 50 | 39006 | 5/8 | 3/8 | .400 | 6100 | 10 FT. |
| 60 | 39007 | 3/4 | 1/2 | 15/16 | 8500 | 10 FT. |
| 80 | 39008 | 1 | 5/8 | 5/8 | 14500 | 10 FT. |

CONNECTING LINKS

- Connecting links are inserted between sections (10 Ft.) of roller chain.



| J&B # | INDUSTRIAL # | QTY |
|-------|--------------|-----|
| 13478 | #35 | 4 |
| 13480 | #40 | 4 |
| 13479 | #41 | 4 |
| 13481 | #50 | 4 |
| 13482 | #60 | 3 |
| 13491 | #80 | 2 |

OFFSET LINKS

- Offset links are used to adjust the length of the chain.



| J&B # | INDUSTRIAL # | QTY |
|-------|--------------|-----|
| 13486 | #35 | 4 |
| 13483 | #40 | 4 |
| 13487 | #41 | 4 |
| 13484 | #50 | 4 |
| 13485 | #60 | 3 |
| 13492 | #80 | 2 |

Replacement links fit specified chain size requirements for repairs on:

- Smaller farm machinery
- Small tractors, tillers
- Printing presses, conveyors
- Cement mixers, washing machines
- Motorcycles and mini-bikes
- Bicycles and Go-Carts
- Industrial Machines
- Aqua-Cats, lawn mowers

HARDWARE

COMMON NAILS

- Bright smooth shank.



| J&B # | SIZE | LENGTH | QTY |
|-------|------|--------|------|
| 46450 | 4D | 1-1/2 | 1 lb |
| 46451 | 6D | 2" | 1 lb |
| 46452 | 8D | 2-1/2 | 1 lb |
| 46453 | 10D | 3" | 1 lb |
| 46454 | 12D | 3-1/4 | 1 lb |
| 46455 | 16D | 3-1/2 | 1 lb |
| 46456 | 20D | 4" | 1 lb |

*Cannot break a box

HEAVY OPEN S HOOKS

- Zinc plated steel.
- Do not use for overhead lifting, support of human weight, athletic or playground equipment. When safety is involved, consult the manufacturer.



| J&B # | SIZE | WEIGHT LIMIT | DIAMETER | UNIT WEIGHT | QTY |
|-------|--------|--------------|----------|-------------|-----|
| 46400 | 1" | 20 lbs. | 1/8 | .006 | 50 |
| 46401 | 1-1/2" | 40 lbs. | 3/16 | .021 | 50 |
| 46402 | 2" | 125 lbs. | 1/4 | .064 | 25 |
| 46403 | 2-1/2" | 140 lbs. | 5/16 | .108 | 25 |

SCREW HOOKS

- Zinc plated steel.
- Do not use for overhead lifting, support of human weight, athletic or playground equipment. When safety is involved, consult the manufacturer.



| J&B # | SIZE | WEIGHT LIMIT | QTY |
|-------|--------------|--------------|-----|
| 70020 | 1/4 x 4-1/4 | 60 lbs. | 10 |
| 70021 | 5/16 x 4-1/2 | 115 lbs. | 10 |
| 70022 | 3/8 x 4-7/8 | 150 lbs. | 10 |

RIVETS

DOMED HEAD

- Aluminum rivets have a polished and sealed finish.
- Steel mandrels are plain with a corrosion protective coating.

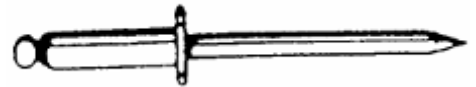

| ALUMINUM DOME / ALUMINUM MANDREL | | | | |
|----------------------------------|---------------|---------|-------------|-----|
| J&B # | DIA. X LENGTH | DRILL # | GRIP RANGE | QTY |
| 13319 | 1/8 x .275 | #30 | 1/16 to 1/8 | 250 |
| 13322 | 1/8 x .400 | #30 | 3/16 to 1/4 | 250 |
| 32091 | 1/8 x .462 | #30 | 1/4 to 5/16 | 250 |
| 13323 | 1/8 x .525 | #30 | 5/16 to 3/8 | 250 |
| 12260 | 1/8 x .650 | #30 | 3/8 to 1/2 | 250 |
| 13326 | 5/32 x .425 | #20 | 3/16 to 1/4 | 250 |
| 13330 | 3/16 x .450 | #11 | 1/8 to 1/4 | 250 |
| 13332 | 3/16 x .575 | #11 | 1/4 to 3/8 | 250 |
| 13334 | 3/16 x .700 | #11 | 3/8 to 1/2 | 250 |
| 32116 | 3/16 x .950 | #11 | 5/8 to 3/4 | 250 |
| 32127 | 3/16 x 1.075 | #11 | 3/4 to 7/8 | 250 |
| 39015 | 1/4 x .625 | F | 1/4 to 3/8 | 100 |

| STEEL DOME / STEEL MANDREL | | | | |
|----------------------------|---------------|---------|-------------|-----|
| J&B # | DIA. X LENGTH | DRILL # | GRIP RANGE | QTY |
| 13317 | 1/8 x .275 | #30 | 1/16 to 1/8 | 250 |
| 13320 | 1/8 x .400 | #30 | 3/16 to 1/4 | 250 |
| 12262 | 1/8 x .525 | #30 | 5/16 to 3/8 | 250 |
| 12263 | 1/8 x .650 | #30 | 3/8 to 1/2 | 250 |
| 32092 | 3/16 x .325 | #11 | 1/16 to 1/8 | 250 |
| 32093 | 3/16 x .450 | #11 | 3/16 to 1/4 | 250 |
| 32094 | 3/16 x .575 | #11 | 1/4 to 3/8 | 250 |
| 32095 | 3/16 x .700 | #11 | 3/8 to 1/2 | 250 |
| 32096 | 1/4 x .625 | F | 1/4 to 3/8 | 100 |
| 32097 | 1/4 x .750 | F | 3/8 to 1/2 | 100 |

DOMED HEAD (Large Flange)



| ALUMINUM DOME / ALUMINUM MANDREL | | | | |
|----------------------------------|---------------|---------|------------|-----|
| J&B # | DIA. X LENGTH | DRILL # | GRIP RANGE | QTY |
| 13337 | 3/16 x .575 | #11 | 1/4 to 3/8 | 250 |
| 13338 | 3/16 x .700 | #11 | 3/8 to 1/2 | 250 |
| 39018 | 3/16 x .950 | #11 | 5/8 to 3/4 | 250 |

| STEEL DOME / STEEL MANDREL | | | | |
|----------------------------|---------------|---------|------------|-----|
| J&B # | DIA. X LENGTH | DRILL # | GRIP RANGE | QTY |
| 12269 | 3/16 x .700 | #11 | 3/8 to 1/2 | 250 |

RIVET CHART

(ACTUAL SIZES)

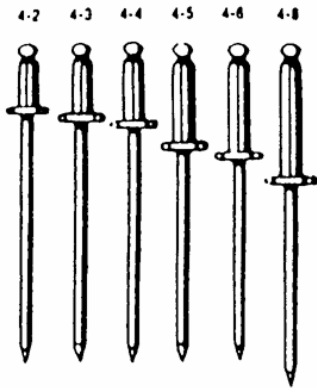

1/8 Diameter

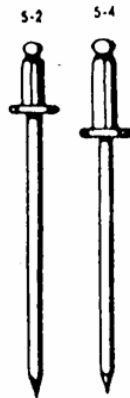

5/32 Diameter

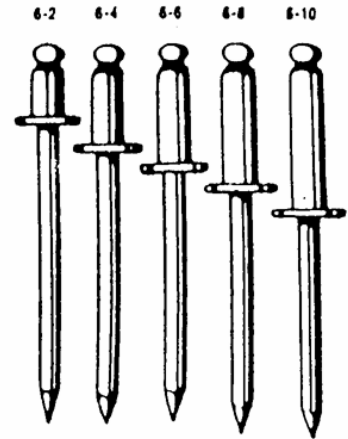

3/16 Diameter

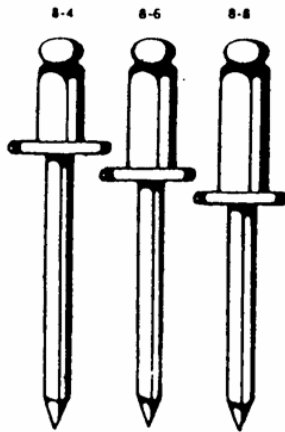

1/4 Diameter

COUNTERSUNK HEAD

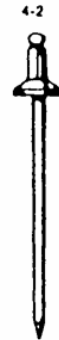

1/8 Diameter

LARGE FLANGE

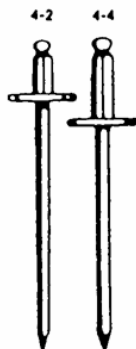

1/8 Diameter

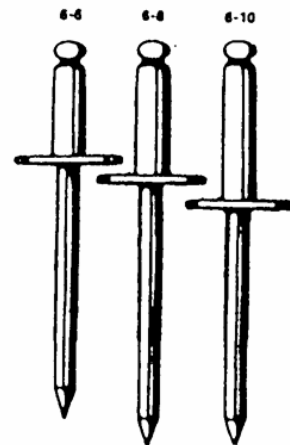

3/16 Diameter

RIVETS

STRUCTURAL - SELF-PLUGGING RIVETS

- **HIGH CLAMP-UP:** The T Rivet will draw sheets firmly together, even when separated by as much as 3/16".
- **NON-CRITICAL HOLE SIZE:** The T Rivet will function properly in holes as much as 1/32" oversize.
- **EXTREMELY HIGH SHEAR AND TENSILE STRENGTH:** The hardened mandrel in the T Rivet provides high tensile strength and shear values comparable to solid rivets or machine screws.

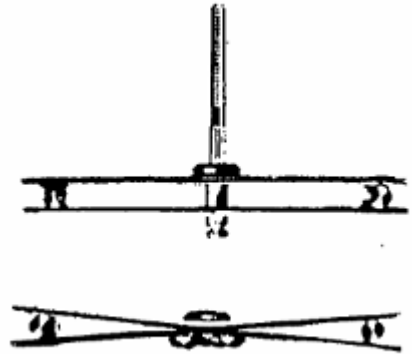

| J&B # | GRIP RANGE | DESCRIPTION | QTY | |
|-------|-------------|---------------------------|-----|--|
| 39196 | .030 / .140 | Window Regulator Rivet | 25 | |
| 39194 | 090 / .115 | Outside Door Handle Rivet | 25 | |

"PEEL TYPE" RIVET

| J&B # | MAKE & YR | PANEL RANGE | HOLE DIA | QTY | |
|-------|--------------------------|---------------|----------|-----|--|
| 41879 | GM, FORD, CHRYSLER 71-ON | 1/32 – 9/64 | 1/4 | 50 | |
| 41881 | GM, FORD, CHEVY 76-ON | 33/64 – 19/32 | 1/4 | 25 | |

"SPLIT-TYPE" RIVET

| J&B # | MAKE & YR | PANEL RANGE | HOLE DIA | QTY | |
|-------|----------------------------------|-------------|----------|-----|--|
| 45904 | FORD 92' -On CHRYSLER 92 - On | 3/16 - 3/8 | 1/4 | 25 | |

RIVETS

BACK UP WASHERS

- Use with domed head rivets.
- Use when fastening soft materials or to compensate for oversize holes.

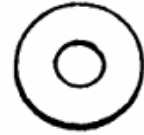

| J&B # | MATERIAL | HOLE SIZE | DIAMETER | QTY |
|-------|----------|-----------|----------|-----|
| 39010 | STEEL | 1/8 | 3/8 | 250 |
| 39011 | STEEL | 3/16 | 1/2 | 250 |
| 39012 | ALUM | 1/8 | 3/8 | 250 |
| 39013 | ALUM | 3/16 | 1/2 | 250 |

NYLON BLIND RIVET

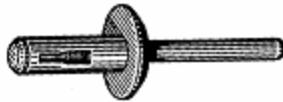

| J&B # | AUVECO # | MAKE & YR | PANEL RANGE | HOLE DIA | QTY |
|-------|----------|----------------|---------------|----------|-----|
| 45830 | 13747 | GM, FORD | 1/16 – 11/64 | 13/64 | 25 |
| 45834 | 13752 | GM | 3/32 – 3/16 | 17/64 | 25 |
| 42098 | 13753 | GM | 3/32 – 3/16 | 17/64 | 25 |
| 45832 | 13751 | GM, FORD, CHRY | 5/32 – 13/32 | 1/4 | 25 |
| 41842 | 13750 | GM, FORD, CHRY | 5/32 – 13/32 | 1/4 | 25 |
| 45836 | 13755 | CHRY | 15/64 – 25/64 | 13/64 | 25 |
| 40914 | 17101 | CHRY, FORD | 5/16 – 15/32 | 1/4 | 25 |

ALUMINUM SPLIT-TYPE RIVET





| J&B # | AUVECO # | MAKE & YR | GRIP RANGE | FLANGE DIA | DIA | QTY |
|-------|----------|-------------------|--------------|------------|------|-----|
| 45858 | 16864 | APV Vans 90' - On | 3/64 – 11/32 | 3/8 | 3/16 | 25 |
| 45860 | 17121 | GM, FORD | 5/64 – 15/64 | 7/16 | 3/16 | 25 |
| 59127 | 14127 | FORD 82' - On | 3/8 – 1/2 | 9/16 | 3/16 | 25 |

RIVETS

ALUMINUM SPLIT-TYPE RIVET

Black

| J&B # | MAKE & YR | GRIP RANGE | FLANGE DIA | DIA | QTY |
|-------|---|--------------|------------|------|-----|
| 59134 | Ford T-Bird & Mercury cougar 89-on  | 1/8 – 3/16 | 3/8 | 1/8 | 50 |
| 59136 | Bumper Fascia & General Purpose GM 1990-on  | 3/64 – 23/64 | 5/8 | 3/16 | 25 |

RIVETS

HEAVY DUTY LEVER RIVET GUN RivetKing

- Full capacity riveting tool capable of setting full range of blind rivet sizes from 1/8" (nose piece sold separately), 5/32", 3/16" and 1/4".
- The geared head design reduces operator effort and fatigue.
- Nose pieces are stored onboard for easy accessibility (5/32", 3/16" & 1/4").



| J&B # | QTY |
|-------|-----|
| 1808 | EA |

HEAVY DUTY PISTOL RIVET GUN RivetKing

- Full capacity riveting tool capable of setting full range of blind rivet sizes up to 5/32" and 3/16" materials excluding high force or structural rivets).
- The best in manual squeeze riveting.
- Nose pieces are stored onboard for easy accessibility (3/32", 1/8", 5/32" & 3/16").

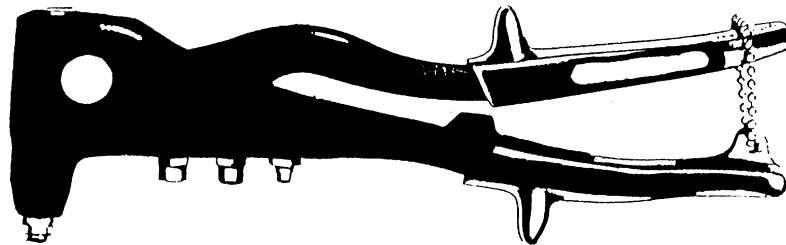

| J&B # | QTY |
|-------|-----|
| 1404 | EA |

RIVETS

PNEUMATIC RIVET GUN RivetKing

- Economy grade pneumatic rivet gun for use on all materials.
- For use on 3/32", 1/8", 5/32" and 3/16" rivets.
- Comes with nose pieces for all the above sizes.

| J&B # | MODEL# | QTY |
|-------|--------|-----|
| 24235 | RK-187 | EA |

- Max. air pressure: 90 PSI * Traction power: 1980 lbs *
Stroke: .625" * Air consumption: .017 CuFt. * Min.
Hose Size: 3/8" ID * Air inlet: 1/4" NPT * Net Weight:
3.3 lbs.



RUBBER 'O' RINGS

- O-Rings effectively resist petroleum-based oils, most silicone fluids, hydraulic, and nonaromatic fuels and solvents.
- Excellent working properties such as low compression set, high tensile strength, and high abrasion resistance.
- Has excellent compression set. Temperature range -65° to +275°.
- Material is Buna N. Durometer is 70.

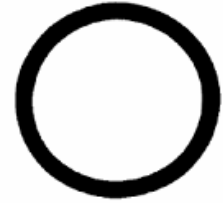

O-RING CROSS REFERENCE

All "O" Rings are manufactured to commercial 6227 specifications for hydraulic use. The OR-number shown is an industry wide numbering system and is used in conjunction with the spec number i.e. 6227-1.

| 1/16" DIAMETER | | | | | |
|----------------|-------|--------|--------|---------|-----|
| J&B # | I. D. | O. D. | NAT. # | ARP # | QTY |
| 12606 | 1/8 | 1/4 | OR-1 | ARP-006 | 25 |
| 12607 | 5/32 | 9/32 | OR-2 | ARP-007 | 25 |
| 12608 | 3/16 | 5/16 | OR-3 | ARP-008 | 25 |
| 12609 | 7/32 | 11/32 | OR-4 | ARP-009 | 25 |
| 12610 | 1/4 | 3/8 | OR-5 | ARP-010 | 25 |
| 12611 | 5/16 | 7/16 | OR-6 | ARP-011 | 25 |
| 12612 | 3/8 | 1/2 | OR-7 | ARP-012 | 25 |
| 39900 | 7/16 | 9/16 | | ARP-013 | 15 |
| 39901 | 1/2 | 5/8 | | ARP-014 | 15 |
| 39902 | 9/16 | 11/16 | | ARP-015 | 15 |
| 39903 | 5/8 | 3/4 | | ARP-016 | 15 |
| 39904 | 11/16 | 13/16 | | ARP-017 | 15 |
| 39905 | 3/4 | 7/8 | | ARP-018 | 15 |
| 39906 | 13/16 | 15/16 | | ARP-019 | 15 |
| 39907 | 7/8 | 1 | | ARP-020 | 15 |
| 39908 | 15/16 | 1-1/16 | | ARP-021 | 15 |
| 39909 | 1 | 1-1/8 | | ARP-022 | 10 |
| 39910 | 1-1/8 | 1-1/4 | | ARP-024 | 10 |
| 39911 | 1-1/4 | 1-3/8 | | ARP-026 | 10 |
| 39912 | 1-3/8 | 1-1/2 | | ARP-028 | 10 |
| 39913 | 1-1/2 | 1-5/8 | | ARP-029 | 10 |
| 39914 | 1-5/8 | 1-3/4 | | ARP-030 | 5 |
| 39915 | 1-3/4 | 1-7/8 | | ARP-031 | 5 |
| 39916 | 1-7/8 | 2 | | ARP-032 | 5 |

RUBBER 'O' RINGS

O-RING CROSS REFERENCE

| 3/32" DIAMETER | | | | | |
|----------------|--------|---------|--------|---------|-----|
| J&B # | I. D. | O. D. | NAT. # | ARP # | QTY |
| 12613 | 3/8 | 9/16 | OR- 8 | ARP-110 | 25 |
| 12614 | 7/16 | 5/8 | OR- 9 | ARP-111 | 25 |
| 12615 | 1/2 | 11/16 | OR-10 | ARP-112 | 25 |
| 12616 | 9/16 | 3/4 | OR-11 | ARP-113 | 10 |
| 12617 | 5/8 | 13/16 | OR-12 | ARP-114 | 10 |
| 12618 | 11/16 | 7/8 | OR-13 | ARP-115 | 10 |
| 12619 | 3/4 | 15/16 | OR-14 | ARP-116 | 10 |
| 39940 | 13/16 | 1 | | ARP-117 | 10 |
| 39941 | 7/8 | 1-1/16 | | ARP-118 | 10 |
| 39942 | 15/16 | 1-1/8 | | ARP-119 | 10 |
| 39943 | 1 | 1-3/16 | | ARP-120 | 10 |
| 39944 | 1-1/16 | 1-1/4 | | ARP-121 | 10 |
| 39945 | 1-1/8 | 1-5/16 | | ARP-122 | 10 |
| 39946 | 1-3/16 | 1-3/8 | | ARP-123 | 10 |
| 39947 | 1-1/4 | 1-7/16 | | ARP-124 | 10 |
| 39948 | 1-3/8 | 1-9/16 | | ARP-126 | 5 |
| 39949 | 1-1/2 | 1-11/16 | | ARP-128 | 5 |
| 39950 | 1-5/8 | 1-13/16 | | ARP-130 | 5 |
| 39951 | 1-3/4 | 1-15/16 | | ARP-132 | 5 |
| 39952 | 1-7/8 | 2-1/16 | | ARP-134 | 5 |
| 39953 | 2 | 2-3/16 | | ARP-136 | 5 |

| 1/8" DIAMETER | | | | | |
|---------------|--------|---------|--------|---------|-----|
| J&B # | I. D. | O. D. | NAT. # | ARP # | QTY |
| 39986 | 11/16 | 15/16 | OR-15 | ARP-209 | 10 |
| 12620 | 3/4 | 1 | OR-16 | ARP-210 | 10 |
| 12621 | 13/16 | 1-1/16 | OR-17 | ARP-211 | 10 |
| 12622 | 7/8 | 1-1/8 | OR-18 | ARP-212 | 10 |
| 12623 | 15/16 | 1-3/16 | OR-19 | ARP-213 | 10 |
| 12624 | 1 | 1-1/4 | OR-20 | ARP-214 | 10 |
| 12625 | 1-1/16 | 1-5/16 | OR-21 | ARP-215 | 10 |
| 12626 | 1-1/8 | 1-3/8 | OR-22 | ARP-216 | 10 |
| 12627 | 1-3/16 | 1-7/16 | OR-23 | ARP-217 | 10 |
| 12628 | 1-1/4 | 1-1/2 | OR-24 | ARP-218 | 10 |
| 12629 | 1-5/16 | 1-9/16 | OR-25 | ARP-219 | 10 |
| 12630 | 1-3/8 | 1-5/8 | OR-26 | ARP-220 | 10 |
| 12631 | 1-7/16 | 1-11/16 | OR-27 | ARP-221 | 10 |
| 12632 | 1-1/2 | 1-3/4 | | ARP-222 | 10 |
| 39980 | 1-5/8 | 1-7/8 | | ARP-223 | 5 |
| 39981 | 1-3/4 | 2 | | ARP-224 | 5 |
| 39982 | 1-7/8 | 2-1/8 | | ARP-225 | 5 |
| 39983 | 2 | 2-1/4 | | ARP-226 | 5 |
| 39984 | 2-1/8 | 2-3/8 | | ARP-227 | 5 |
| 39985 | 2-1/4 | 2-1/2 | | ARP-228 | 5 |

RUBBER 'O' RINGS

O-RING CROSS REFERENCE

| 3/16" DIAMETER | | | | | |
|----------------|-------|-------|--------|---------|-----|
| J&B # | I. D. | O. D. | NAT. # | ARP # | QTY |
| 12633 | 1-1/2 | 1-7/8 | OR-28 | ARP-325 | 10 |
| 12634 | 1-5/8 | 2 | OR-29 | ARP-326 | 10 |
| 12635 | 1-3/4 | 2-1/8 | OR-30 | ARP-327 | 10 |
| 13448 | 1-7/8 | 2-1/4 | OR-31 | ARP-328 | 5 |
| 13449 | 2 | 2-3/8 | OR-32 | ARP-329 | 5 |
| 13450 | 2-1/8 | 2-1/2 | OR-33 | ARP-330 | 5 |
| 13451 | 2-1/4 | 2-5/8 | OR-34 | ARP-331 | 5 |
| 13452 | 2-3/8 | 2-3/4 | OR-35 | ARP-332 | 5 |
| 13453 | 2-1/2 | 2-7/8 | OR-36 | ARP-333 | 5 |
| 13454 | 2-5/8 | 3 | OR-37 | ARP-334 | 5 |
| 13455 | 2-3/4 | 3-1/8 | OR-38 | ARP-335 | 5 |
| 13456 | 2-7/8 | 3-1/4 | OR-39 | ARP-336 | 5 |
| 13457 | 3 | 3-3/8 | OR-40 | ARP-337 | 5 |

RUBBER 'O' RINGS

1/16" WIDTH



| | |
|--------|---------|
| 12606 | QTY. 25 |
| 1/8 ID | 1/4 OD |

| | |
|---------|---------|
| 12607 | QTY. 25 |
| 5/32 ID | 9/32 OD |

| | |
|---------|---------|
| 12608 | QTY. 25 |
| 3/16 ID | 5/16 OD |

| | |
|---------|----------|
| 12609 | QTY. 25 |
| 7/32 ID | 11/32 OD |



| | |
|--------|---------|
| 12610 | QTY. 25 |
| 1/4 ID | 3/8 OD |

| | |
|---------|---------|
| 12611 | QTY. 25 |
| 5/16 ID | 7/16 OD |

| | |
|--------|---------|
| 12612 | QTY. 25 |
| 3/8 ID | 1/2 OD |

RUBBER 'O' RINGS

3/32" WIDTH



| | |
|--------|---------|
| 12613 | QTY. 25 |
| 3/8 ID | 9/16 OD |

| | |
|---------|---------|
| 12614 | QTY. 25 |
| 7/16 ID | 5/8 OD |

| | |
|--------|----------|
| 12615 | QTY. 25 |
| 1/2 ID | 11/16 OD |

| | |
|---------|---------|
| 12616 | QTY. 10 |
| 9/16 ID | 3/4 OD |



| | |
|--------|----------|
| 12617 | QTY. 10 |
| 5/8 ID | 13/16 OD |

| | |
|----------|---------|
| 12618 | QTY. 10 |
| 11/16 ID | 7/8 OD |

| | |
|--------|----------|
| 12619 | QTY. 10 |
| 3/4 ID | 15/16 OD |

1/8" WIDTH



| | |
|--------|---------|
| 12620 | QTY. 10 |
| 3/4 ID | 1" OD |

| | |
|----------|-----------|
| 12621 | QTY. 10 |
| 13/16 ID | 1-1/16 OD |

| | |
|--------|----------|
| 12622 | QTY. 10 |
| 7/8 ID | 1-1/8 OD |

| | |
|----------|-----------|
| 12623 | QTY. 10 |
| 15/16 ID | 1-3/16 OD |

RUBBER 'O' RINGS

1/8" WIDTH



| | |
|-------|----------|
| 12624 | QTY. 10 |
| 1" ID | 1-1/4 OD |



| | |
|-----------|-----------|
| 12625 | QTY. 10 |
| 1-1/16 ID | 1-5/16 OD |

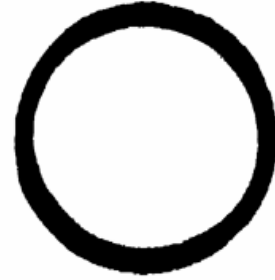

| | |
|----------|----------|
| 12626 | QTY. 10 |
| 1-1/8 ID | 1-3/8 OD |

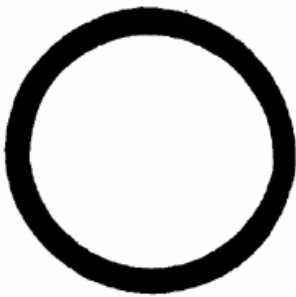

| | |
|-----------|-----------|
| 12627 | QTY. 10 |
| 1-3/16 ID | 1-7/16 OD |

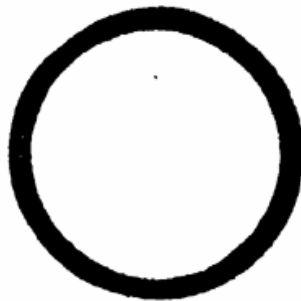

| | |
|----------|----------|
| 12628 | QTY. 10 |
| 1-1/4 ID | 1-1/2 OD |

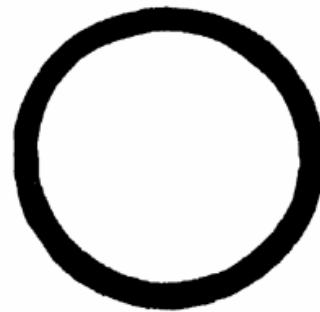

| | |
|-----------|-----------|
| 12629 | QTY. 10 |
| 1-5/16 ID | 1-9/16 OD |



| | |
|----------|----------|
| 12630 | QTY. 10 |
| 1-3/8 ID | 1-5/8 OD |

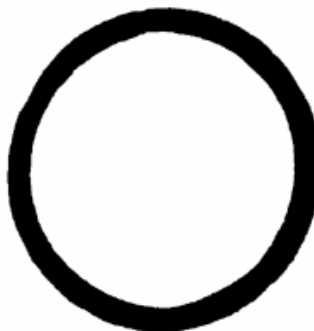

| | |
|-----------|------------|
| 12631 | QTY. 10 |
| 1-7/16 ID | 1-11/16 OD |

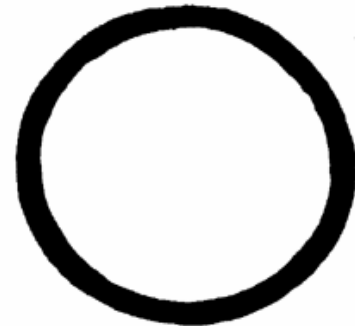

| | |
|----------|----------|
| 12632 | QTY. 10 |
| 1-1/2 ID | 1-3/4 OD |

RUBBER 'O' RINGS

3/16" WIDTH

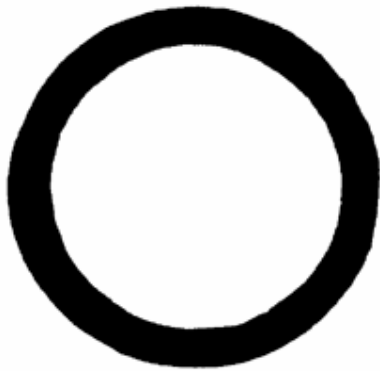

| | |
|----------|----------|
| 12633 | QTY. 10 |
| 1-1/2 ID | 1-7/8 OD |



| | |
|----------|---------|
| 12634 | QTY. 10 |
| 1-5/8 ID | 2" OD |

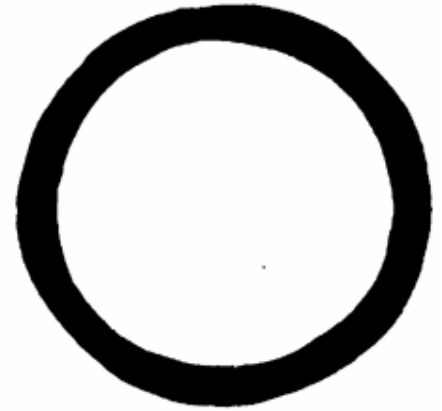

| | |
|----------|----------|
| 12635 | QTY. 10 |
| 1-3/4 ID | 2-1/8 OD |

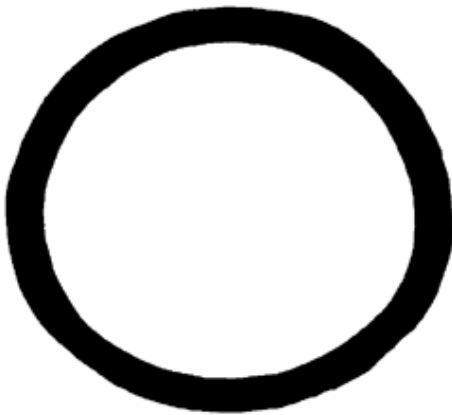

| | |
|----------|----------|
| 13448 | QTY. 5 |
| 1-7/8 ID | 2-1/4 OD |

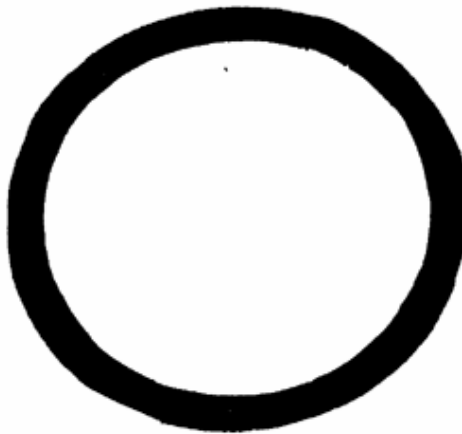

| | |
|-------|----------|
| 13449 | QTY. 5 |
| 2" ID | 2-3/8 OD |

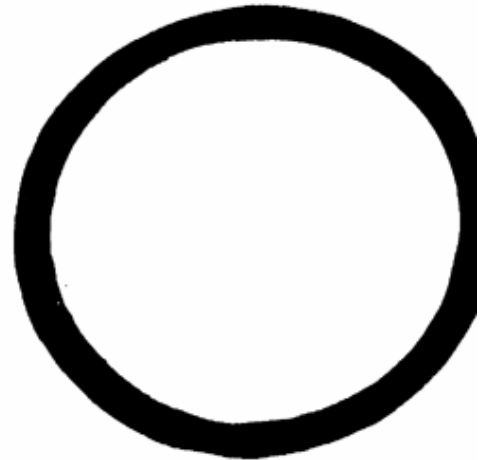

| | |
|----------|----------|
| 13450 | QTY. 5 |
| 2-1/8 ID | 2-1/2 OD |

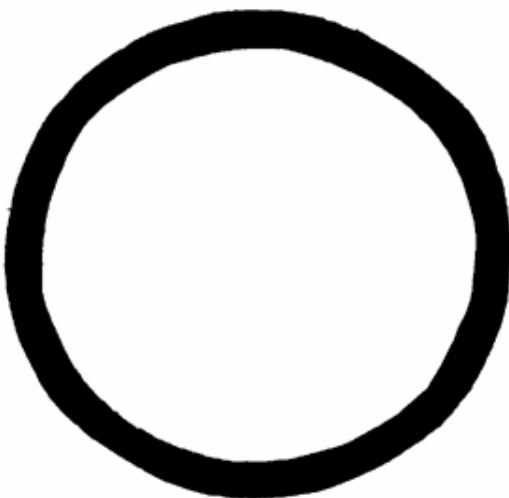

| | |
|----------|----------|
| 13451 | QTY. 5 |
| 2-1/4 ID | 2-5/8 OD |

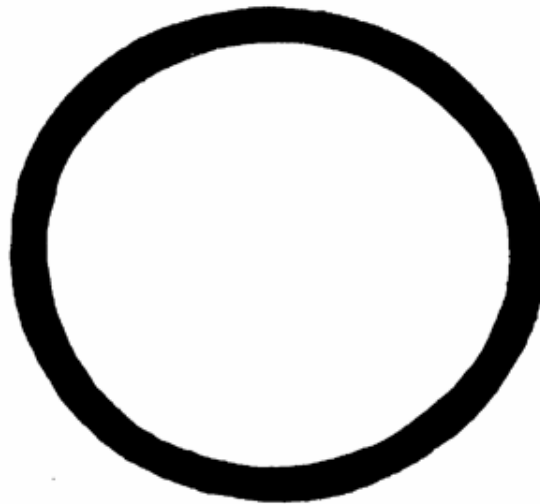

| | |
|----------|----------|
| 13452 | QTY. 5 |
| 2-3/8 ID | 2-3/4 OD |



RUBBER 'O' RINGS

3/16" WIDTH

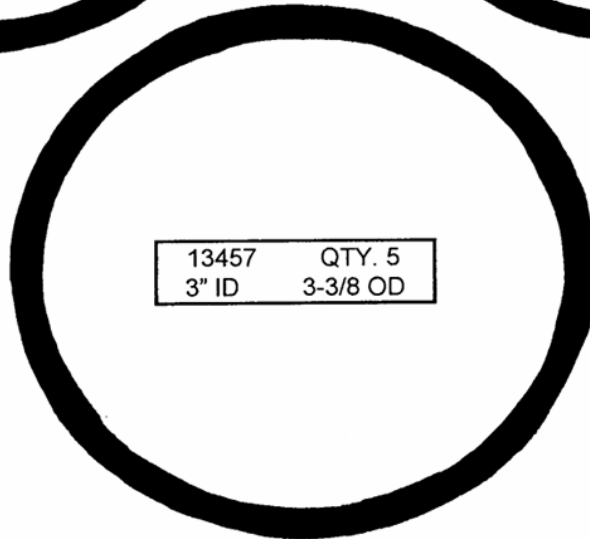
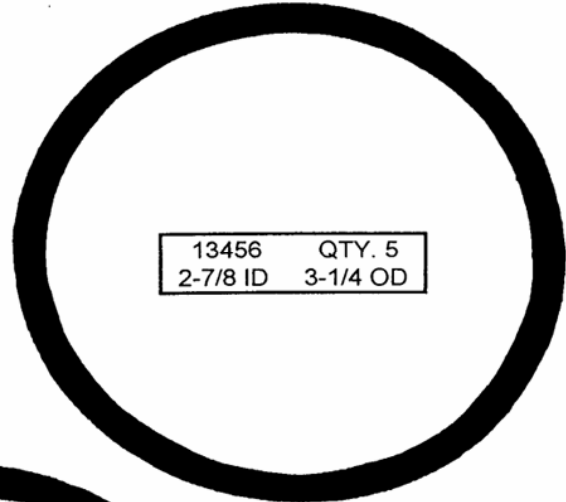
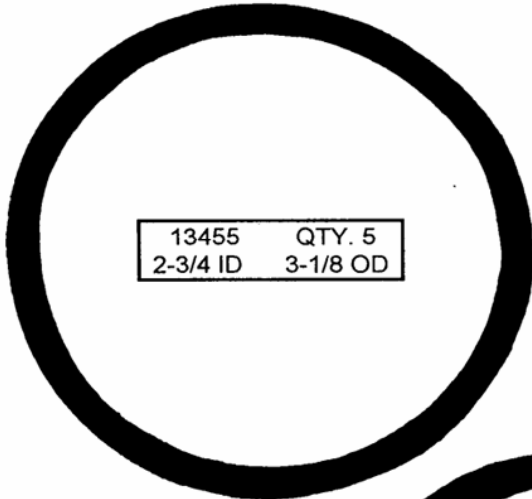
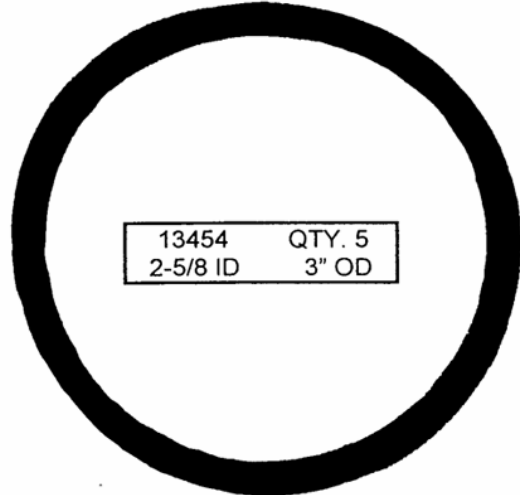
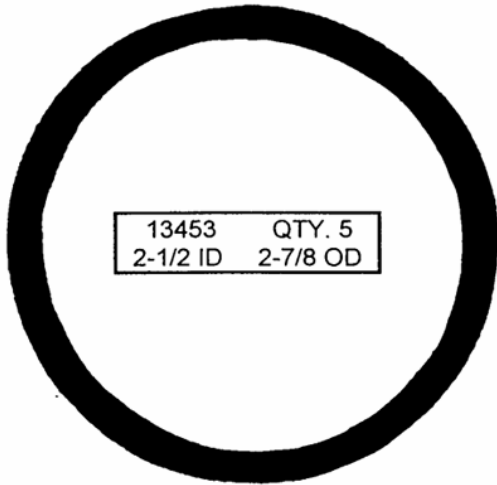

RUBBER 'O' RINGS

SIZING CHART

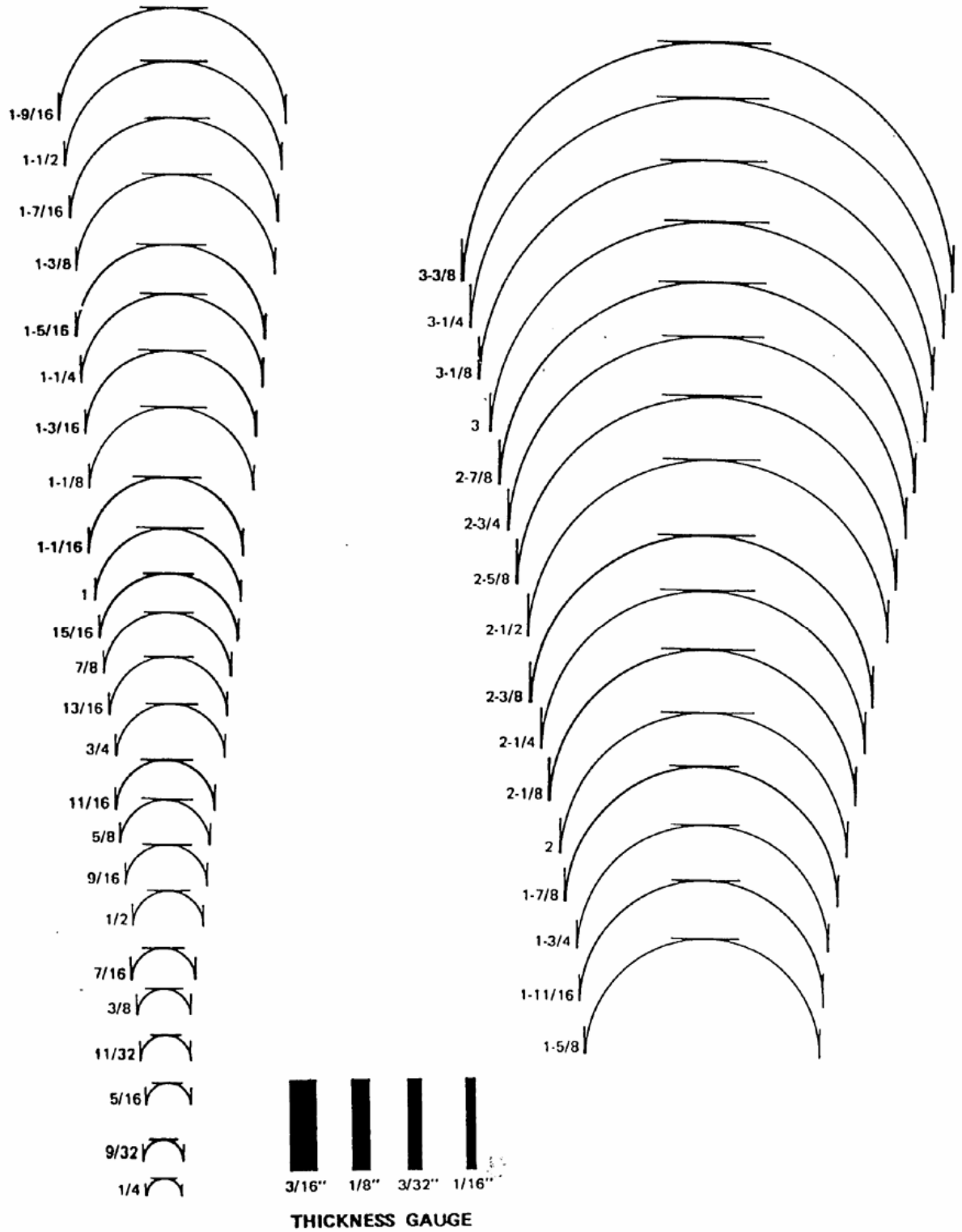

RUBBER 'O' RINGS

HNBR O-RING ASSORTMENT High Temperature

- 270 piece kit contains 18 popular o-ring sizes.
- Hydrogenated Nitrile Butadiene Rubber (HNBR), also known as Highly Saturated Nitrile (HSN) is a special class of nitrile rubber & is for mission critical applications.
- Temperature range of -49 F (-45 C) to 329 F (165 C).
- HNBR is classified by ASTM as DH-type polymer.
- Suitable for many hydrocarbons, fats, oils, gas, etc..
- **NOT SUITABLE FOR USE WITH BRAKE FLUIDS.**
- Good Abrasion resistance & resistant to compression.
- High Tensile strength.



| I/D | Section | I/D | Section |
|-------|---------|------|---------|
| 7/32 | 1/16 | 7.8 | 1.9 |
| 1/4 | 1/16 | 8.8 | 1.9 |
| 5/16 | 1/16 | 13.9 | 1.9 |
| 7/16 | 1/16 | 8 | 2 |
| 11/16 | 1/16 | 11 | 2 |
| 7/16 | 3/32 | 12 | 2 |
| 9/16 | 3/32 | 14 | 2 |
| 11/16 | 1/8 | 15 | 2 |
| 6.8 | 1.9 | 17 | 2 |

| J&B # | QTY |
|-------|-----|
| 2283 | EA |

**O-RING ASSORTMENTS...
SEE PAGES 2546 – 2549 & PAGE 2592**

METRIC O-RINGS LOCATED ON PAGE 2549

RUBBER 'O' RINGS

O-RING SPLICING KIT

- Makes any size O-ring from cord or wrong size keys.
- Eliminates delays from out-of-stock situations.
- Works with most ring materials.
- Replaces rings without machine disassembly.

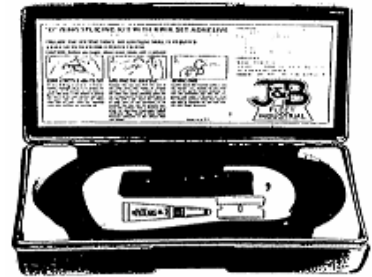

| J&B # | QTY |
|-------|-----|
| 38800 | EA |

REPLACEMENT BUNA-N CORD STOCK

| J&B # | DIAMETER | LENGTH | QTY |
|-------|----------|--------|-----|
| 39045 | 3/32 | 3' | EA |
| 39046 | 1/8 | 3' | EA |
| 39047 | 3/16 | 3' | EA |
| 39048 | 1/4 | 3' | EA |

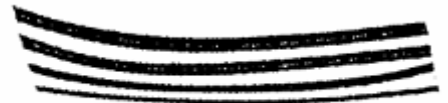

RUBBER GROMMETS

- For protecting and insulating automotive and industrial wiring, cables, tubing, etc., installed through metal paneling.
- Used to prevent vibration, wire or tubing damage, and shorts.

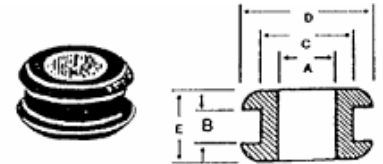

| J&B # | A BORE DIAMETER | B GROOVE WIDTH | C GROOVE DIAMETER | D OUTSIDE DIAMETER | E OVERALL THICKNESS | QTY |
|-------|-----------------------|----------------------|-------------------------|--------------------------|---------------------------|-----|
| 38201 | 1/8 | 3/32 | 3/8 | 1/2 | 5/16 | 25 |
| 38172 | 5/32 | 1/16 | 1/4 | 3/8 | 3/16 | 25 |
| 38202 | 3/16 | 1/16 | 5/16 | 1/2 | 1/4 | 25 |
| 38173 | 3/16 | 1/4 | 5/16 | 7/16 | 3/8 | 25 |
| 38204 | 1/4 | 1/16 | 7/16 | 5/8 | 3/16 | 25 |
| 38205 | 1/4 | 1/16 | 1" | 1-1/4 | 1/4 | 25 |
| 38206 | 5/16 | 1/16 | 9/16 | 13/16 | 5/16 | 25 |
| 38207 | 5/16 | 1/8 | 9/16 | 13/16 | 3/8 | 25 |
| 38208 | 5/16 | 1/4 | 9/16 | 13/16 | 1/2 | 25 |
| 38209 | 3/8 | 1/16 | 1/2 | 5/8 | 9/32 | 25 |
| 38210 | 3/8 | 1/16 | 1" | 1-1/4 | 1/4 | 25 |
| 38213 | 1/2 | 3/32 | 3/4 | 31/32 | 9/32 | 25 |
| 38216 | 1/2 | 1/4 | 13/16 | 1-1/16 | 1/2 | 25 |
| 38217 | 5/8 | 1/8 | 7/8 | 1-1/8 | 3/8 | 25 |
| 38218 | 5/8 | 1/16 | 7/8 | 1-1/8 | 5/16 | 25 |
| 38220 | 3/4 | 1/16 | 1-1/16 | 1-3/8 | 3/8 | 25 |
| 38221 | 3/4 | 1/16 | 1-1/4 | 1-5/8 | 1/4 | 25 |
| 38222 | 3/4 | 1/4 | 1-1/4 | 1-5/8 | 7/16 | 25 |

RETAINING RINGS

INTERNAL SNAP TYPE

(Rings Actual Size)

- Internal rings fit in a groove in the housing bore.
- Unlimited universal applications: Industrial, power equipment, cars, trucks, garden equipment.



#10638 QTY. 50
1/4" Housing



#10639 QTY. 50
5/16" Housing



#10640 QTY. 25
3/8" Housing



#10641 QTY. 25
7/16" Housing



#10642 QTY. 25
1/2" Housing



#10643 QTY. 25
9/16" Housing



#10644 QTY. 20
5/8" Housing



#40030 QTY. 15
11/16" Housing



#10645 QTY. 25
3/4" Housing



#40031 QTY. 15
13/16" Housing



#10646 QTY. 15
7/8" Housing



#10647 QTY. 10
1" Housing



#40032 QTY. 10
1-1/16" Housing



#10648 QTY. 10
1-1/8" Housing

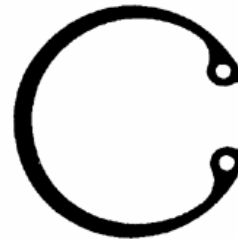

#40033 QTY. 10
1-3/16" Housing

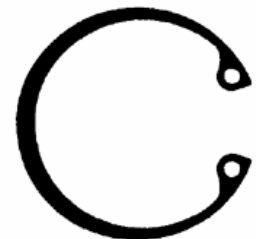

#10649 QTY. 10
1-1/4" Housing

RETAINING RINGS

INTERNAL SNAP TYPE (Rings Actual Size)

- Internal rings fit in a groove in the housing bore.
- Unlimited universal applications: Industrial, power equipment, cars, trucks, garden equipment.

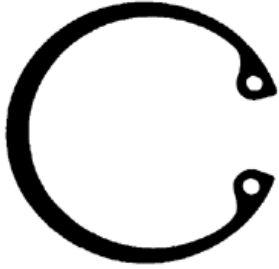

#40044 QTY. 10
1-5/16" Housing

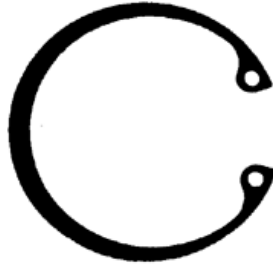

#40045 QTY. 10
1-3/8" Housing

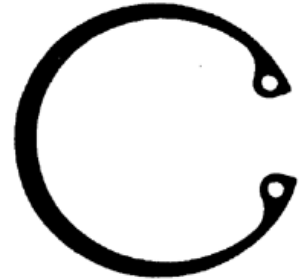

#40046 QTY. 10
1-7/16" Housing

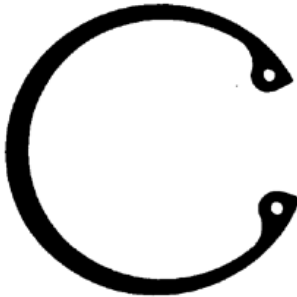

#40047 QTY. 10
1-1/2" Housing

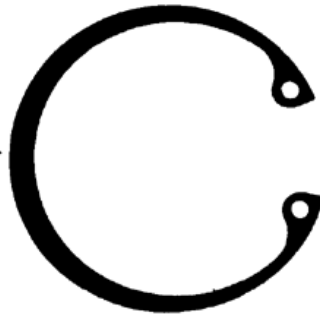

#40048 QTY. 10
1-5/8" Housing

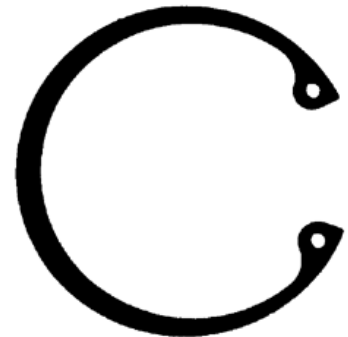

#40049 QTY. 10
1-3/4" Housing

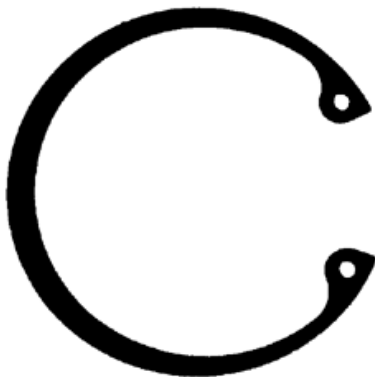

#86999 QTY. 10
2" Housing

RETAINING RINGS

EXTERNAL SNAP TYPE (Rings Actual Size)

- Rings require a groove on the shaft.
- Unlimited universal applications: cars, trucks, industrial, power equipment.



#87000 QTY. 50
1/8" Shaft



#40055 QTY. 50
3/16" Shaft



#10650 QTY. 50
1/4" Shaft



#40056 QTY. 50
9/32" Shaft



#10651 QTY. 50
5/16" Shaft



#40057 QTY. 50
11/32" Shaft



#10652 QTY. 25
3/8" Shaft



#87001 QTY. 25
13/32" Shaft



#10653 QTY. 25
7/16" Shaft



#10654 QTY. 25
1/2" Shaft



#10655 QTY. 20
9/16" Shaft



#10656 QTY. 20
5/8" Shaft



#10762 QTY. 15
11/16" Shaft



#10657 QTY. 15
3/4" Shaft



#87002 QTY. 15
13/16" Shaft



#10658 QTY. 15
7/8" Shaft

RETAINING RINGS

EXTERNAL SNAP TYPE (Rings Actual Size)

- Rings require a groove on the shaft.
- Unlimited universal applications: cars, trucks, industrial, power equipment.



#87003 QTY. 10
15/16" Shaft



#10659 QTY. 10
1" Shaft



#40058 QTY. 10
1-1/16" Shaft



#10660 QTY. 10
1-1/8" Shaft



#40059 QTY. 10
1-3/16" Shaft



#10661 QTY. 10
1-1/4" Shaft



#40060 QTY. 10
1-5/16" Shaft



#40061 QTY. 10
1-3/8" Shaft



#40062 QTY. 10
1-7/16" Shaft

RETAINING RINGS

EXTERNAL SNAP TYPE (Rings Actual Size)

- Rings require a groove on the shaft.



#40063 QTY. 10
1-1/2" Shaft



#40064 QTY. 10
1-5/8" Shaft



#40065 QTY. 10
1-3/4" Shaft



#87004 QTY. 10
1-7/8" Shaft



#40066 QTY. 10
2" Shaft



#87005 QTY. 5
2-1/8" Shaft

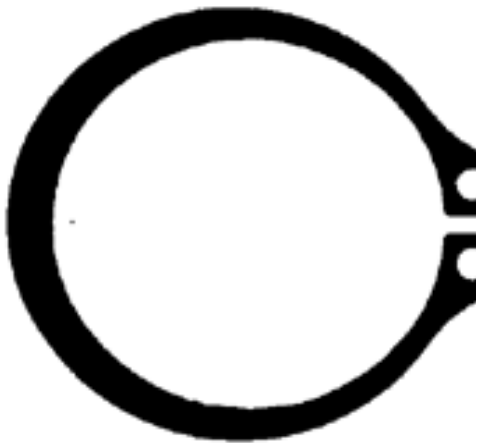

#87006 QTY. 5
2-1/4" Shaft

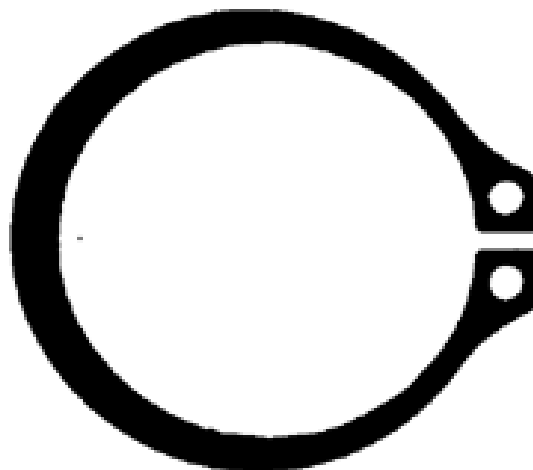

#87007 QTY. 5
2-3/8" Shaft

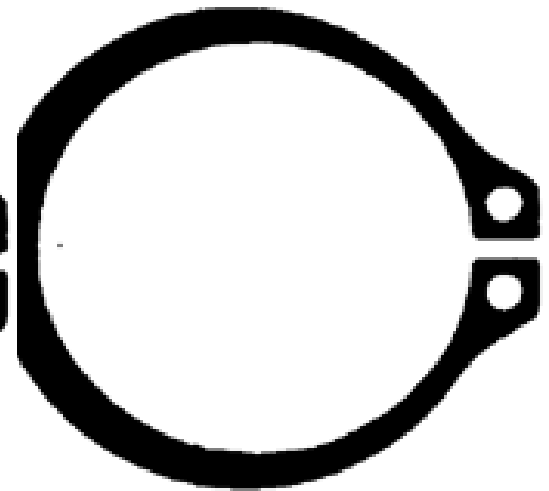

#87008 QTY. 5
2-1/2" Shaft

RETAINING RINGS

E TYPE

(Rings Actual Size)

- These external rings provide three-way contact.
- Unlimited universal applications: Industrial, machinery, cars, trucks, snow plows.



#12706 QTY 100
1/16" Shaft



#12711 QTY 100
3/32" Shaft



#12712 QTY 100
1/8" Shaft



#12707 QTY 100
9/64" Shaft



#12713 QTY 100
5/32" Shaft



#12708 QTY 100
11/64" Shaft



#12714 QTY 100
3/16" Shaft



#12717 QTY 100
7/32" Shaft



#12715 QTY 50
1/4" Shaft



#12716 QTY 50
5/16" Shaft



#10951 QTY. 25
3/8" Shaft



#12718 QTY. 25
7/16" Shaft



#12719 QTY. 25
1/2" Shaft



#12768 QTY. 25
9/16" Shaft



#11094 QTY. 25
5/8" Shaft

RETAINING RINGS

E TYPE (Rings Actual Size)

- These external rings provide three-way contact.
- Unlimited universal applications: Industrial, machinery, cars, trucks, snow plows.



#11095 QTY. 25
3/4" Shaft



#11096 QTY. 20
7/8" Shaft



#11097 QTY. 20
1" Shaft



#12709 QTY. 20
1-3/16" Shaft



#12710 QTY. 20
1-3/8" Shaft

RETAINING RINGS

SNAP RING PLIERS

- Vise-grip, 4 piece, convertible snap ring pliers.
- **One pair replaces 2 for internal or external use.**
- Includes 4 interchangeable tips for ease in moving from 1 project to the next.
- Pro touch grips provide extra comfort for less hand fatigue.
- Retaining ring pliers set includes two 180 degrees tips, one 90 degree tip & one 45 degree tip.

| J&B # | QTY |
|-------|-----|
| 57048 | EA |





J&B Fleet - Industrial Supply

























22428 Harrisburg-Westville Rd. Alliance, Ohio 44601 Phone: (330) 821-6342 Fax: (330) 821-0411

www.jbfleet.com



PART # 2021

COTTER PINS 1/16 – 5/32

| | | | | | |
|---|---|---|---|---|---|
| <p>12330 ¹</p>  <p>50 1/16 X 1/2</p> | <p>12331 ²</p>  <p>50 1/16 X 3/4</p> | <p>12332 ³</p>  <p>50 1/16 X 1</p> | <p>12333 ⁴</p>  <p>50 1/16 X 1-1/4</p> | <p>12334 ⁵</p>  <p>50 1/16 X 1-1/2</p> | <p>12336 ⁶</p>  <p>50 1/16 X 2</p> |
| <p>12337 ⁷</p>  <p>50 3/32 X 1/2</p> | <p>12338 ⁸</p>  <p>50 3/32 X 3/4</p> | <p>12339 ⁹</p>  <p>50 3/32 X 1</p> | <p>12340 ¹⁰</p>  <p>50 3/32 X 1-1/4</p> | <p>12341 ¹¹</p>  <p>50 3/32 X 1-1/2</p> | <p>12343 ¹²</p>  <p>50 3/32 X 2</p> |
| <p>12347 ¹³</p>  <p>50 1/8 X 3/4</p> | <p>12348 ¹⁴</p>  <p>50 1/8 X 1</p> | <p>12349 ¹⁵</p>  <p>50 1/8 X 1-1/4</p> | <p>12350 ¹⁶</p>  <p>50 1/8 X 1-1/2</p> | <p>12351 ¹⁷</p>  <p>50 1/8 X 1-3/4</p> | <p>12352 ¹⁸</p>  <p>50 1/8 X 2</p> |
| <p>12356 ¹⁹</p>  <p>50 5/32 X 3/4</p> | <p>12357 ²⁰</p>  <p>50 5/32 X 1</p> | <p>12358 ²¹</p>  <p>50 5/32 X 1-1/4</p> | <p>12359 ²²</p>  <p>50 5/32 X 1-1/2</p> | <p>12361 ²³</p>  <p>50 5/32 X 2</p> | <p>12363 ²⁴</p>  <p>50 5/32 X 2-1/2</p> |





















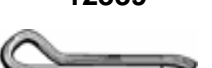
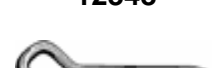
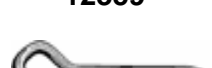
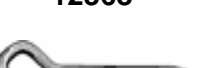
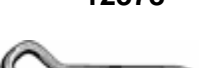

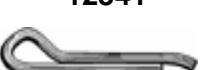
J&B Fleet - Industrial Supply

22428 Harrisburg-Westville Rd. Alliance, Ohio 44601 Phone: (330) 821-6342 Fax: (330) 821-0411

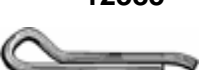
www.jbfleet.com

PART # 2095

COTTER PINS

| | | | | | |
|---|---|--|---|---|--|
|  12330 ¹ 1/16 X 1/2 50 |  12337 ² 3/32 X 1/2 50 |  12347 ³ 1/8 X 3/4 50 |  12356 ⁴ 5/32 X 3/4 25 |  12365 ⁵ 3/16 X 3/4 20 |  12376 ⁶ 1/4 X 1-1/2 10 |
|  12332 ⁷ 1/16 X 1 50 |  12339 ⁸ 3/32 X 1 50 |  12348 ⁹ 1/8 X 1 50 |  12359 ¹⁰ 5/32 X 1-1/2 25 |  12368 ¹¹ 3/16 X 1-1/2 20 |  12378 ¹² 1/4 X 2 10 |
|  12334 ¹³ 1/16 X 1-1/2 50 |  12341 ¹⁴ 3/32 X 1-1/2 50 |  12350 ¹⁵ 1/8 X 1-1/2 25 |  12361 ¹⁶ 5/32 X 2 25 |  12370 ¹⁷ 3/16 X 2 10 |  12385 ¹⁸ 5/16 X 1-1/2 5 |
|  12336 ¹⁹ 1/16 X 2 25 |  12343 ²⁰ 3/32 X 2 25 |  12352 ²¹ 1/8 X 2 25 |  12363 ²² 5/32 X 2-1/2 20 |  12374 ²³ 1/4 X 1 10 |  12386 ²⁴ 5/16 X 2 5 |



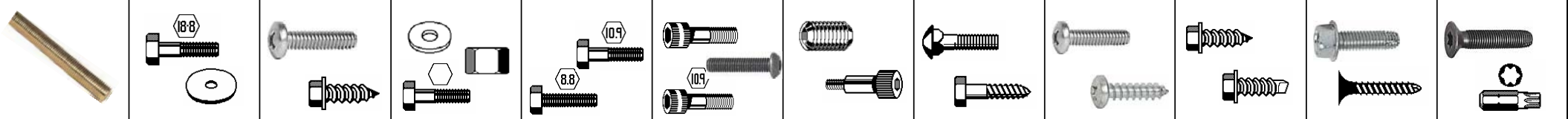

























J&B Fleet - Industrial Supply

22428 Harrisburg-Westville Rd. Alliance, Ohio 44601 Phone: (330) 821-6342 Fax: (330) 821-0411

www.jbfleet.com

PART # 2020

COTTER PINS 3/16 – 3/8

| | | | | | |
|--|--|---|---|---|---|
| <p>12365 ¹</p>  <p>35</p> <p>3/16 X 3/4</p> | <p>12366 ²</p>  <p>35</p> <p>3/16 X 1</p> | <p>12367 ³</p>  <p>35</p> <p>3/16 X 1-1/4</p> | <p>12368 ⁴</p>  <p>35</p> <p>3/16 X 1-1/2</p> | <p>12370 ⁵</p>  <p>35</p> <p>3/16 X 2</p> | <p>12373 ⁶</p>  <p>35</p> <p>3/16 X 3</p> |
| <p>12372 ⁷</p>  <p>35</p> <p>3/16 X 2-1/2</p> | <p>12374 ⁸</p>  <p>15</p> <p>1/4 X 1</p> | <p>12375 ⁹</p>  <p>15</p> <p>1/4 X 1-1/4</p> | <p>12376 ¹⁰</p>  <p>15</p> <p>1/4 X 1-1/2</p> | <p>12381 ¹¹</p>  <p>15</p> <p>1/4 X 3</p> | <p>12384 ¹²</p>  <p>15</p> <p>1/4 X 3</p> |
| <p>12377 ¹³</p>  <p>15</p> <p>1/4 X 1-3/4</p> | <p>12378 ¹⁴</p>  <p>15</p> <p>1/4 X 2</p> | <p>12380 ¹⁵</p>  <p>15</p> <p>1/4 X 2-1/2</p> | <p>12384 ¹⁶</p>  <p>15</p> <p>5/16 X 1</p> | <p>12388 ¹⁷</p>  <p>10</p> <p>5/16 X 3</p> | <p>12388 ¹⁸</p>  <p>10</p> <p>5/16 X 3</p> |
| <p>12385 ¹⁹</p>  <p>15</p> <p>5/16 X 1-1/2</p> | <p>12386 ²⁰</p>  <p>15</p> <p>5/16 X 2</p> | <p>12392 ²¹</p>  <p>10</p> <p>3/8 X 2</p> | <p>12393 ²²</p>  <p>10</p> <p>3/8 X 3</p> | <p>12393 ²³</p>  <p>10</p> <p>3/8 X 3</p> | <p>12393 ²⁴</p>  <p>10</p> <p>3/8 X 3</p> |

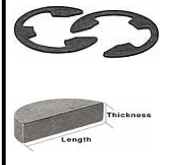
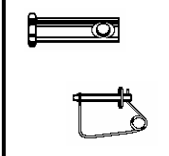
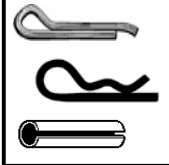
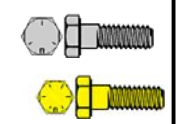
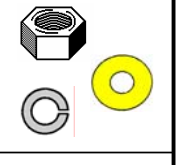
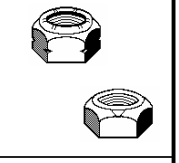
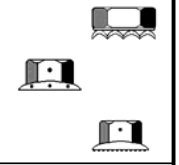































J&B Fleet - Industrial Supply

22428 Harrisburg-Westville Rd. Alliance, Ohio 44601 Phone: (330) 821-6342 Fax: (330) 821-0411

www.jbfleet.com

PART # 2218

COTTER PINS

| | | | | | | | |
|--|--|--|---|---|--|--|---|
|  12330 ¹ 1/16 X 1/2 50 |  12332 ² 1/16 X 1 50 |  12334 ³ 1/16 X 1-1/2 50 |  12336 ⁴ 1/16 X 2 25 |  12337 ⁵ 3/32 X 1/2 50 |  12339 ⁶ 3/32 X 1 50 |  12341 ⁷ 3/32 X 1-1/2 50 |  12343 ⁸ 3/32 X 2 25 |
|  12347 ⁹ 1/8 X 3/4 50 |  12348 ¹⁰ 1/8 X 1 50 |  12349 ¹¹ 1/8 X 1-1/4 25 |  12350 ¹² 1/8 X 1-1/2 25 |  12352 ¹³ 1/8 X 2 25 |  12356 ¹⁴ 5/32 X 3/4 25 |  12357 ¹⁵ 5/32 X 1 25 |  12358 ¹⁶ 5/32 X 1-1/4 25 |
|  12359 ¹⁷ 5/32 X 1-1/2 25 |  12361 ¹⁸ 5/32 X 2 25 |  12365 ¹⁹ 3/16 X 3/4 20 |  12366 ²⁰ 3/16 X 1 20 |  12367 ²¹ 3/16 X 1-1/4 20 |  12369 ²² 3/16 X 1-1/2 10 |  12370 ²³ 3/16 X 2 10 |  12374 ²⁴ 1/4 X 1 10 |
|  12375 ²⁵ 1/4 X 1-1/4 10 |  12376 ²⁶ 1/4 X 1-1/2 10 | 27 |  12378 ²⁸ 1/4 X 2 10 | 29 |  12385 ³⁰ 5/16 X 1-1/2 5 | 31 |  12386 ³² 5/16 X 2 5 |



LET US HELP YOU MAKE THE CONNECTION

PART# 3004

COTTER PINS



J & B FLEET-INDUSTRIAL SUPPLY
PHONE: 330-821-6342



| | | | | | |
|--|--|--|--|--|---|
| 12330 1/16 X 1/2 25 | 12332 1/16 X 1 25 | 12339 3/32 X 1 25 | 12341 3/32 X 1-1/2 25 | 12348 1/8 X 1 25 | 12350 1/8 X 1-1/2 10 |
| 12352 1/8 X 2 10 | 12359 5/32 X 1-1/2 10 | 12361 5/32 X 2 10 | 12365 3/16 X 3/4 10 | 12368 3/16 X 1-1/2 10 | 12370 3/16 X 2 5 |



















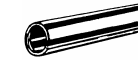







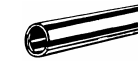
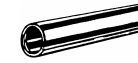

J&B Fleet - Industrial Supply

22428 Harrisburg-Westville Rd. Alliance, Ohio 44601 Phone: (330) 821-6342 Fax: (330) 821-0411

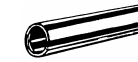
www.jbfleet.com

PART #2246

SPRING PINS

| | | | | | | | |
|---|--|--|--|--|---|---|--|
|  12400 ¹ 1/16 X 1/2 25 |  12402 ² 1/16 X 3/4 25 |  12405 ³ 5/64 X 1/2 20 |  12407 ⁴ 5/64 X 3/4 20 |  12411 ⁵ 3/32 X 3/4 20 |  12414 ⁶ 3/32 X 1 20 |  12418 ⁷ 1/8 X 3/4 20 |  12420 ⁸ 1/8 X 1 20 |
|  12421 ⁹ 1/8 X 1 1/4 15 |  12422 ¹⁰ 1/8 X 1 1/2 15 |  12426 ¹¹ 5/32 X 1 15 |  12428 ¹² 5/32 X 1-1/2 10 |  12432 ¹³ 3/16 X 1 10 |  12433 ¹⁴ 3/16 X 1-1/4 10 |  12434 ¹⁵ 3/16 X 1-1/2 10 |  12436 ¹⁶ 3/16 X 2 5 |
|  12438 ¹⁷ 7/32 X 1 10 |  12440 ¹⁸ 7/32 X 1-1/2 5 |  12442 ¹⁹ 7/32 X 2 5 |  12444 ²⁰ 1/4 X 1 10 |  12445 ²¹ 1/4 X 1-1/4 10 |  12447 ²² 1/4 X 1-1/2 5 |  12448 ²³ 1/4 X 2 5 | 12449 ²⁴ |
|  12466 ²⁵ 5/16 X 1 5 |  12468 ²⁶ 5/16 X 1-1/2 5 |  12470 ²⁷ 5/16 X 2 5 | 12471 ²⁸ |  12453 ²⁹ 3/8 X 1 5 |  12455 ³⁰ 3/8 X 1-1/2 5 |  12457 ³¹ 3/8 X 2 5 | 12458 ³² |





J&B Fleet - Industrial Supply







22428 Harrisburg-Westville Rd. Alliance, Ohio 44601 Phone: (330) 821-6342 Fax: (330) 821-0411

www.jbfleet.com

PART # 2016

ROLL PINS 1/16 – 1/4

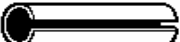
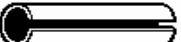
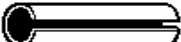
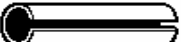
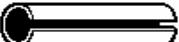
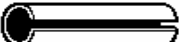
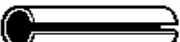
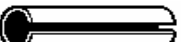
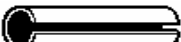
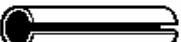
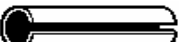
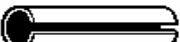
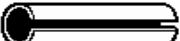
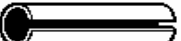
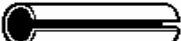
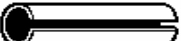
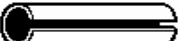
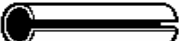

| | | | | | |
|---|---|---|---|--|--|
| <p>12401 ¹</p>  <p>25 1/16 X 1/4</p> | <p>12400 ²</p>  <p>25 1/16 X 1/2</p> | <p>12402 ³</p>  <p>25 1/16 X 3/4</p> | <p>12403 ⁴</p>  <p>25 5/64 X 1/4</p> | <p>12405 ⁵</p>  <p>25 5/64 X 1/2</p> | <p>12407 ⁶</p>  <p>25 5/64 X 3/4</p> |
| <p>12410 ⁷</p>  <p>25 3/32 X 1/2</p> | <p>12411 ⁸</p>  <p>25 3/32 X 3/4</p> | <p>12414 ⁹</p>  <p>25 3/32 X 1</p> | <p>12415 ¹⁰</p>  <p>25 1/8 X 3/8</p> | <p>12418 ¹¹</p>  <p>25 1/8 X 3/4</p> | <p>12422 ¹²</p>  <p>20 1/8 X 1-1/2</p> |
| <p>12423 ¹³</p>  <p>25 5/32 X 1/2</p> | <p>12426 ¹⁴</p>  <p>25 5/32 X 1</p> | <p>12428 ¹⁵</p>  <p>20 5/32 X 1-1/2</p> | <p>12429 ¹⁶</p>  <p>25 3/16 X 1/2</p> | <p>12432 ¹⁷</p>  <p>20 3/16 X 1</p> | <p>12436 ¹⁸</p>  <p>15 3/16 X 2</p> |
| <p>12437 ¹⁹</p>  <p>25 7/32 X 3/4</p> | <p>12440 ²⁰</p>  <p>20 7/32 X 1-1/2</p> | <p>12442 ²¹</p>  <p>15 7/32 X 2</p> | <p>12444 ²²</p>  <p>20 1/4 X 1</p> | <p>12448 ²³</p>  <p>10 1/4 X 2</p> | <p>12452 ²⁴</p>  <p>5 1/4 X 3</p> |



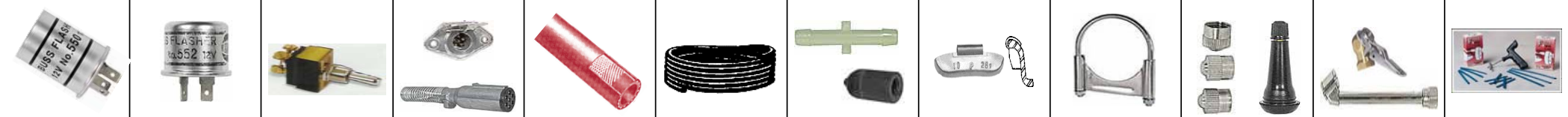













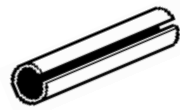

J&B Fleet - Industrial Supply

22428 Harrisburg-Westville Rd. Alliance, Ohio 44601 Phone: (330) 821-6342 Fax: (330) 821-0411

www.jbfleet.com

PART # 2017

ROLL PINS 5/16 – 1/2

| | | | |
|---|--|---|--|
|  32085 1 15 5/16 X 3/4 |  12466 2 15 5/16 X 1 |  12468 3 10 5/16 X 1-1/2 |  12470 4 10 5/16 X 2 |
|  12453 5 10 3/8 X 1 |  12455 6 10 3/8 X 1-1/2 |  12457 7 5 3/8 X 2 |  12459 8 5 3/8 X 2-1/2 |
|  12461 9 10 3/8 X 3 |  25172 14 5 1/2 X 2 |  12481 11 5 7/16 X 1-1/2 |  25171 12 5 1/2 X 1-1/4 |
|  12482 13 10 1/2 X 1-1/2 |  12483 15 5 1/2 X 3 |  25173 16 3 1/2 X 4 | |

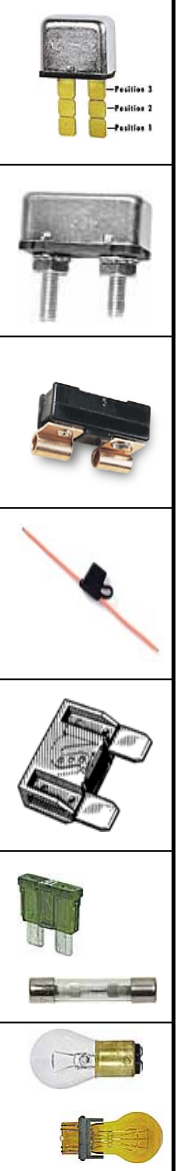
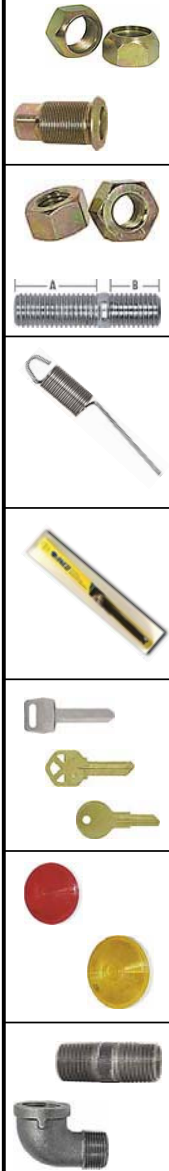



















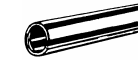







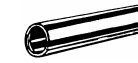
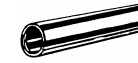

J&B Fleet - Industrial Supply

22428 Harrisburg-Westville Rd. Alliance, Ohio 44601 Phone: (330) 821-6342 Fax: (330) 821-0411

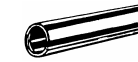
www.jbfleet.com

PART #2246

SPRING PINS

| | | | | | | | |
|---|--|--|--|--|---|---|--|
|  12400 ¹ 1/16 X 1/2 25 |  12402 ² 1/16 X 3/4 25 |  12405 ³ 5/64 X 1/2 20 |  12407 ⁴ 5/64 X 3/4 20 |  12411 ⁵ 3/32 X 3/4 20 |  12414 ⁶ 3/32 X 1 20 |  12418 ⁷ 1/8 X 3/4 20 |  12420 ⁸ 1/8 X 1 20 |
|  12421 ⁹ 1/8 X 1 1/4 15 |  12422 ¹⁰ 1/8 X 1 1/2 15 |  12426 ¹¹ 5/32 X 1 15 |  12428 ¹² 5/32 X 1-1/2 10 |  12432 ¹³ 3/16 X 1 10 |  12433 ¹⁴ 3/16 X 1-1/4 10 |  12434 ¹⁵ 3/16 X 1-1/2 10 |  12436 ¹⁶ 3/16 X 2 5 |
|  12438 ¹⁷ 7/32 X 1 10 |  12440 ¹⁸ 7/32 X 1-1/2 5 |  12442 ¹⁹ 7/32 X 2 5 |  12444 ²⁰ 1/4 X 1 10 |  12445 ²¹ 1/4 X 1-1/4 10 |  12447 ²² 1/4 X 1-1/2 5 |  12448 ²³ 1/4 X 2 5 | 12449 ²⁴ |
|  12466 ²⁵ 5/16 X 1 5 |  12468 ²⁶ 5/16 X 1-1/2 5 |  12470 ²⁷ 5/16 X 2 5 | 12471 ²⁸ |  12453 ²⁹ 3/8 X 1 5 |  12455 ³⁰ 3/8 X 1-1/2 5 |  12457 ³¹ 3/8 X 2 5 | 12458 ³² |

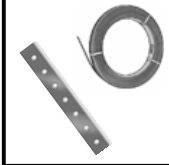

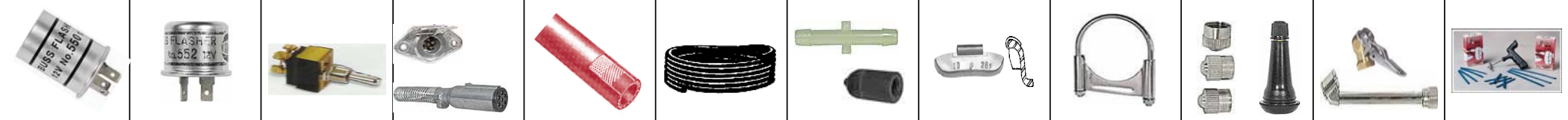



















J&B Fleet - Industrial Supply

www.jbfleet.com

22428 Harrisburg-Westville Rd. Alliance, Ohio 44601 Phone: (330) 821-6342 Fax: (330) 821-0411

PART # 2137

SPRING PINS

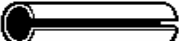
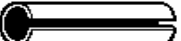
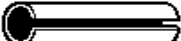
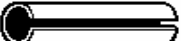
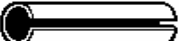
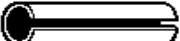
| | | | | | |
|---|--|---|--|--|---|
| <p>12400 ¹</p>  <p>1/16 X 1/2</p> <p>20</p> | <p>12402 ²</p>  <p>1/16 X 3/4</p> <p>20</p> | <p>12405 ³</p>  <p>5/64 X 1/2</p> <p>20</p> | <p>12407 ⁴</p>  <p>5/64 X 3/4</p> <p>20</p> | <p>12411 ⁵</p>  <p>3/32 X 3/4</p> <p>20</p> | <p>12452 ⁶</p>  <p>1/4 X 3</p> <p>5</p> |
| <p>12414 ⁷</p>  <p>3/32 X 1</p> <p>20</p> | <p>12418 ⁸</p>  <p>1/8 X 3/4</p> <p>20</p> | <p>12420 ⁹</p>  <p>1/8 X 1</p> <p>20</p> | <p>12422 ¹⁰</p>  <p>1/8 X 1-1/2</p> <p>20</p> | <p>12426 ¹¹</p>  <p>5/32 X 1</p> <p>20</p> | <p>12457 ¹²</p>  <p>3/8 X 2</p> <p>5</p> |
| <p>12428 ¹³</p>  <p>5/32 X 1-1/2</p> <p>20</p> | <p>12432 ¹⁴</p>  <p>3/16 X 1</p> <p>10</p> | <p>12436 ¹⁵</p>  <p>3/16 X 2</p> <p>10</p> | <p>12440 ¹⁶</p>  <p>7/32 X 1</p> <p>10</p> | <p>12442 ¹⁷</p>  <p>7/32 X 2</p> <p>10</p> | <p>12461 ¹⁸</p>  <p>3/8 X 3</p> <p>5</p> |
| <p>12444 ¹⁹</p>  <p>1/4 X 1</p> <p>10</p> | <p>12448 ²⁰</p>  <p>1/4 X 2</p> <p>10</p> | <p>12466 ²¹</p>  <p>5/16 X 1</p> <p>10</p> | <p>12470 ²²</p>  <p>5/16 X 2</p> <p>5</p> | <p>12453 ²³</p>  <p>3/8 X 1</p> <p>5</p> | <p>12483 ²⁴</p>  <p>1/2 X 3</p> <p>5</p> |



LET US HELP YOU MAKE THE CONNECTION

Part # 3005

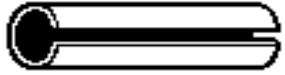

ROLL PINS



J & B FLEET-INDUSTRIAL SUPPLY
PHONE: 330-821-6342

| | | | | | |
|--|--|--|---|--|--|
| 12402 1/16 x 3/4 10 | 12414 3/32 x 1 10 | 12420 1/8 x 1 10 | 12422 1/8 x 1-1/2 10 | 12426 5/32 x 1 10 | 12428 5/32 x 1-1/2 10 |
| 12432 3/16 x 1 10 | 12436 3/16 x 2 10 | 12440 7/32 x 1 10 | 12442 7/32 x 2 10 | 12444 1/4 x 1 10 | 12448 1/4 x 2 10 |



















J&B Fleet - Industrial Supply

www.jbfleet.com

22428 Harrisburg-Westville Rd. Alliance, Ohio 44601 Phone: (330) 821-6342 Fax: (330) 821-0411

PART # 2089

HAIRPINS

| | | | |
|---|---|---|--|
| <p>50</p> <p>13264</p>  <p>1/32 X 5/8</p> | <p>10</p> <p>13276</p>  <p>7/64 X 1-5/8</p> | <p>10</p> <p>13256</p>  <p>9/64 X 2-1/2</p> | <p>3</p>  <p>41055</p> <p>PIN DIA 1/4</p> <p>EFFECTIVE LENGTH 1-3/8</p> |
| <p>50</p> <p>13266</p>  <p>3/64 X 1"</p> | <p>10</p> <p>13254</p>  <p>7/64 X 2-5/16</p> | <p>10</p> <p>13280</p>  <p>9/64 X 2-7/8</p> | <p>3</p>  <p>41056</p> <p>PIN DIA 5/16</p> <p>EFFECTIVE LENGTH 2-1/4</p> |
| <p>25</p> <p>13268</p>  <p>1/16 X 1-9/16</p> | <p>10</p> <p>13278</p>  <p>1/8 X 1-1/4</p> | <p>5</p> <p>13282</p>  <p>5/32 X 2-15/16</p> | |
| <p>25</p> <p>13270</p>  <p>5/64 X 1-9/16</p> | <p>10</p> <p>13262</p>  <p>9/64 X 1-15/16</p> | <p>3</p> <p>13260</p>  <p>3/16 X 3-3/4</p> | |
| <p>25</p> <p>13272</p>  <p>5/64 X 1-7/8</p> | | | |
| <p>25</p> <p>13274</p>  <p>3/32 X 1-9/16</p> | | | |

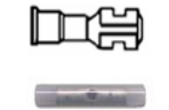

LET US HELP YOU MAKE THE CONNECTION

PART # 3008

HAIRPINS



J & B FLEET-INDUSTRIAL SUPPLY
PHONE: 330-821-6342



| 13270 | 13274 | 13254 | 13256 | 13282 | 13260 |
|---------------|---------------|---------------|--------------|----------------|--------------|
| 5/64 x 1-9/16 | 3/32 x 1-9/16 | 7/64 x 2-5/16 | 9/64 x 2-1/2 | 5/32 x 2-15/16 | 3/16 x 3-3/4 |
| 25 | 25 | 10 | 10 | 10 | 5 |













J&B Fleet - Industrial Supply

www.jbfleet.com

22428 Harrisburg-Westville Rd. Alliance, Ohio 44601 Phone: (330) 821-6342 Fax: (330) 821-0411

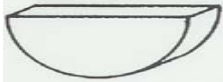
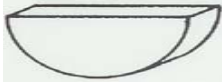
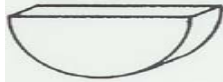
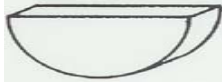
PART # 2032

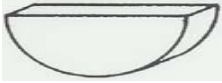
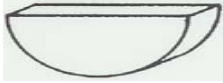
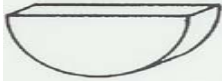
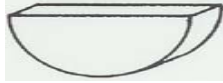
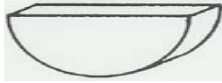
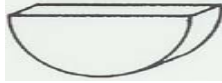
WOODRUFF KEYS

| | | | | | |
|--|---|---|---|--|--|
| <p>12586 ¹</p>  <p>15 3/32 X 1/2</p> | <p>12587 ²</p>  <p>15 3/32 X 5/8</p> | <p>12588 ³</p>  <p>15 1/8 X 1/2</p> | <p>12589 ⁴</p>  <p>15 1/8 X 5/8</p> | <p>12590 ⁵</p>  <p>10 5/32 X 5/8</p> | <p>12591 ⁶</p>  <p>10 5/32 X 3/4</p> |
| <p>12592 ⁷</p>  <p>10 5/32 X 7/8</p> | <p>12593 ⁸</p>  <p>10 3/16 X 3/4</p> | <p>12594 ⁹</p>  <p>10 3/16 X 7/8</p> | <p>12595 ¹⁰</p>  <p>10 3/16 X 1</p> | <p>12596 ¹¹</p>  <p>5 1/4 X 3/4</p> | <p>12597 ¹²</p>  <p>5 1/4 X 7/8</p> |
| <p>12598 ¹³</p>  <p>5 1/4 X 1</p> | <p>12599 ¹⁴</p>  <p>5 1/4 X 1-1/8</p> | <p>12600 ¹⁵</p>  <p>5 1/4 X 1-1/4</p> | <p>12601 ¹⁶</p>  <p>5 5/16 X 1</p> | <p>12602 ¹⁷</p>  <p>5 5/16 X 1-1/8</p> | <p>12603 ¹⁸</p>  <p>5 5/16 X 1-1/4</p> |
| <p>12604 ¹⁹</p>  <p>3 3/8 X 1</p> | <p>12605 ²⁰</p>  <p>3 3/8 X 1-1/4</p> | <p>²¹</p> | <p>²²</p> | <p>²³</p> | <p>²⁴</p> |



LET US HELP YOU MAKE THE CONNECTION

PART # 3007

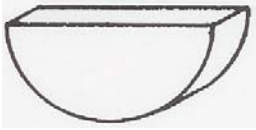

WOODRUFF KEYS



J & B FLEET-INDUSTRIAL SUPPLY
PHONE: 330-821-6342

| | | | | | |
|---|--|--|--|--|---|
| 12586 3/32 x 1/2 5 | 12587 3/32 x 5/8 5 | 12588 1/8 x 1/2 5 | 12589 1/8 x 5/8 5 | 12590 5/32 x 5/8 5 | 12591 5/32 x 3/4 5 |
| 12593 3/16 x 3/4 5 | 12594 3/16 x 7/8 5 | 12595 3/16 x 1 5 | 12596 1/4 x 3/4 3 | 12597 1/4 x 7/8 3 | 12598 1/4 x 1 3 |
| 12600 1/4 x 1-1/4 3 | 12601 5/16 x 1 2 | 12602 5/16 x 1-1/8 2 | 12603 5/16 x 1-1/4 2 | 12604 3/8 x 1 2 | 12605 3/8 x 1-1/4 2 |



J&B Fleet - Industrial Supply

www.jbfleet.com

22428 Harrisburg-Westville Rd. Alliance, Ohio 44601 Phone: (330) 821-6342 Fax: (330) 821-0411

PART # 2238

SNAP & LYNCH PINS

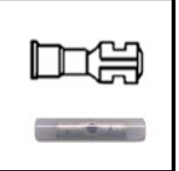

| | | |
|---|--|--|
| <p>41055 1</p> <p>5 PIN DIA. 1/4 EFFECTIVE LENGTH 1-3/8</p> | <p>41057 2</p> <p>5 PIN DIA. 3/16 EFFECTIVE LENGTH 1</p> | <p>41066 3</p> <p>5 PIN DIA. 5/16 EFFECTIVE LENGTH 1-1/4</p> |
| <p>41054 4</p> <p>5 PIN DIA. 1/4 EFFECTIVE LENGTH 2-1/4</p> | <p>41062 5</p> <p>5 PIN DIA. 3/16 EFFECTIVE LENGTH 1-1/4</p> | <p>41064 6</p> <p>5 PIN DIA. 5/16 EFFECTIVE LENGTH 1-3/8</p> |
| <p>41056 7</p> <p>5 PIN DIA. 5/16 EFFECTIVE LENGTH 2-1/4</p> | <p>41063 8</p> <p>5 PIN DIA. 1/4 EFFECTIVE LENGTH 1-1/4</p> | <p>41060 9</p> <p>5 PIN DIA. 7/16 EFFECTIVE LENGTH 1-5/8</p> |
| <p>41061 10</p> <p>5 PIN DIA. 3/8 EFFECTIVE LENGTH 2-1/4</p> | <p>41059 11</p> <p>5 PIN DIA. 1/4 EFFECTIVE LENGTH 1-5/16</p> | <p>41065 12</p> <p>5 PIN DIA. 7/16 EFFECTIVE LENGTH 1-3/4</p> |



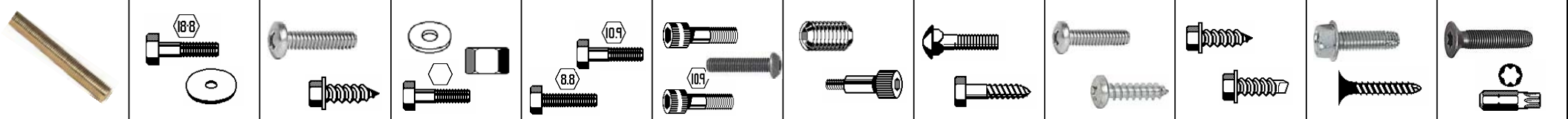









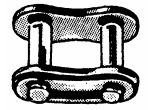

J&B Fleet - Industrial Supply

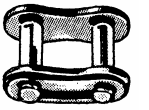
22428 Harrisburg-Westville Rd. Alliance, Ohio 44601 Phone: (330) 821-6342 Fax: (330) 821-0411

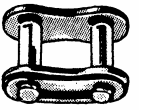
www.jbfleet.com

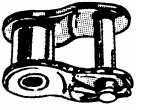
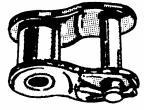
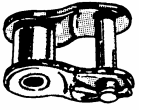
PART # 2225

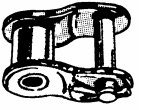
CHAIN LINKS

| | | | | | |
|---|---|---|---|---|---|
| <p>13478 ¹</p>  <p>#35 CONNECTING LINKS</p> <p>4</p> | <p>13480 ²</p>  <p>#40 CONNECTING LINKS</p> <p>4</p> | <p>13479 ³</p>  <p>#41 CONNECTING LINKS</p> <p>4</p> | <p>13481 ⁴</p>  <p>#50 CONNECTING LINKS</p> <p>4</p> | <p>13482 ⁵</p>  <p>#60 CONNECTING LINKS</p> <p>3</p> | <p>13491 ⁶</p>  <p>#80 CONNECTING LINKS</p> <p>2</p> |
| <p>⁷</p> | <p>⁸</p> | <p>⁹</p> | <p>¹⁰</p> | <p>¹¹</p> | <p>¹²</p> |
| <p>13486 ¹³</p>  <p>#35 OFFSET LINKS</p> <p>4</p> | <p>13483 ¹⁴</p>  <p>#40 OFFSET LINKS</p> <p>4</p> | <p>13487 ¹⁵</p>  <p>#41 OFFSET LINKS</p> <p>4</p> | <p>13484 ¹⁶</p>  <p>#50 OFFSET LINKS</p> <p>4</p> | <p>13485 ¹⁷</p>  <p>#60 OFFSET LINKS</p> <p>3</p> | <p>13492 ¹⁸</p>  <p>#80 OFFSET LINKS</p> <p>2</p> |
| <p>¹⁹</p> | <p>²⁰</p> | <p>²¹</p> | <p>²²</p> | <p>²³</p> | <p>²⁴</p> |



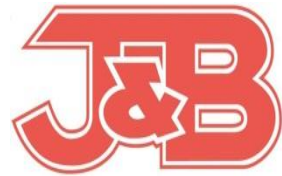

J&B Fleet - Industrial Supply

www.jbfleet.com

22428 Harrisburg-Westville Rd. Alliance, Ohio 44601 Phone: (330) 821-6342 Fax: (330) 821-0411

SNAP SAFETY PIN

PART # 2598



| | | |
|--|---|--|
| <p>41055 1</p> <p>PIN DIA. 1/4 EFFECTIVE LENGTH 1-3/8</p> | <p>39226 2</p> <p>PIN DIA. 5/16 EFFECTIVE LENGTH 1-3/8</p> | <p>39229 3</p> <p>PIN DIA. 3/8 EFFECTIVE LENGTH 1-1/2</p> |
| <p>41054 4</p> <p>PIN DIA. 1/4 EFFECTIVE LENGTH 2-1/4</p> | <p>41056 5</p> <p>PIN DIA. 5/16 EFFECTIVE LENGTH 2-1/4</p> | <p>41061 6</p> <p>PIN DIA. 3/8 EFFECTIVE LENGTH 2-1/4</p> |
| <p>39225 7</p> <p>PIN DIA. 1/4 EFFECTIVE LENGTH 2-1/2</p> | <p>39227 8</p> <p>PIN DIA. 5/16 EFFECTIVE LENGTH 2-1/2</p> | <p>39230 9</p> <p>PIN DIA. 3/8 EFFECTIVE LENGTH 2-1/2</p> |
| <p>10</p> | <p>39228 11</p> <p>PIN DIA. 5/16 EFFECTIVE LENGTH 3</p> | <p>39231 12</p> <p>PIN DIA. 3/8 EFFECTIVE LENGTH 3</p> |









J&B Fleet - Industrial Supply

www.jbfleet.com

22428 Harrisburg-Westville Rd. Alliance, Ohio 44601 Phone: (330) 821-6342 Fax: (330) 821-0411

PART # 2898

LYNCH PINS

| | | |
|---|---|---|
|  41057 1 PIN DIA. 3/16 EFFECTIVE LENGTH 1 |  41062 2 PIN DIA. 3/16 EFFECTIVE LENGTH 1-1/4 |  39232 3 PIN DIA. 3/16 EFFECTIVE LENGTH 1-3/4 |
|  41063 4 PIN DIA. 1/4 EFFECTIVE LENGTH 1-1/4 |  41059 5 PIN DIA. 1/4 EFFECTIVE LENGTH 1-5/16 |  41079 6 PIN DIA. 1/4 EFFECTIVE LENGTH 1-3/4 |
|  41066 7 PIN DIA. 5/16 EFFECTIVE LENGTH 1-1/4 |  41064 8 PIN DIA. 5/16 EFFECTIVE LENGTH 1-3/8 |  41080 9 PIN DIA. 5/16 EFFECTIVE LENGTH 1-3/4 |
|  41060 10 PIN DIA. 7/16 EFFECTIVE LENGTH 1-5/8 |  41065 11 PIN DIA. 7/16 EFFECTIVE LENGTH 1-3/4 |  41081 12 PIN DIA. 7/16 EFFECTIVE LENGTH 2-1/4 |



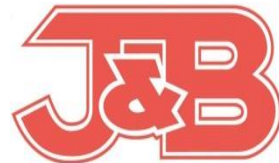











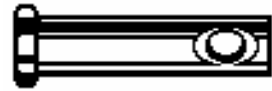
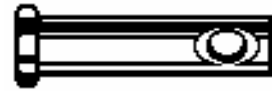



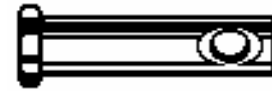







J&B Fleet - Industrial Supply

22428 Harrisburg-Westville Rd. Alliance, Ohio 44601 Phone: (330) 821-6342 Fax: (330) 821-0411

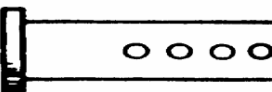
www.jbfleet.com

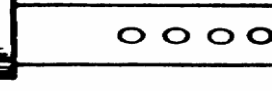
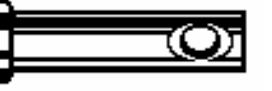
PART # 2198

CLEVIS PINS (zinc plated)

| | | | | | |
|---|--|---|---|--|--|
|  37480 ¹ 5 3/16 X 1/2 |  37481 ² 5 3/16 X 3/4 |  37482 ³ 5 3/16 X 1 |  37483 ⁴ 5 3/16 X 1-1/2 |  37486 ⁵ 5 1/4 X 3/4 |  37499 ⁶ 2 1/2 X 3 |
|  37500 ⁷ 5 1/4 X 1 |  37501 ⁸ 5 1/4 X 1-1/4 |  37502 ⁹ 5 1/4 X 1-1/2 |  13185 ¹⁰ 5 1/4 X 2 |  37506 ¹¹ 5 5/16 X 1 |  37498 ¹² 2 1/2 X 2-1/2 |
|  37507 ¹³ 5 5/16 X 1-1/4 |  37508 ¹⁴ 5 5/16 X 1-1/2 |  13186 ¹⁵ 5 5/16 X 2 |  37512 ¹⁶ 5 3/8 X 1 |  37513 ¹⁷ 5 3/8 X 1-1/4 |  13189 ¹⁸ 2 1/2 X 2 |
|  37514 ¹⁹ 5 3/8 X 1-1/2 |  13187 ²⁰ 5 3/8 x 2 |  37490 ²¹ 2 7/16 x 1-1/4 |  37524 ²² 2 7/16 x 1-1/2 |  13188 ²³ 2 7/16 x 2 |  40505 ²⁴ 2 1/2 X 1-1/2 |





















J&B Fleet - Industrial Supply

www.jbfleet.com

22428 Harrisburg-Westville Rd. Alliance, Ohio 44601 Phone: (330) 821-6342 Fax: (330) 821-0411

PART # 2061

ALUMINUM BLIND RIVETS

| | | | |
|--|---|---|---|
| <p>39012</p>  <p>1/8 BACK-UP WASHER</p> <p>50</p> | <p>13323</p>  <p>DOMED HEAD 1/8 DIAMETER</p> <p>GRIP .313 - .375</p> <p>50</p> | <p>13332</p>  <p>DOMED HEAD 3/16 DIAMETER</p> <p>GRIP .251 - .375</p> <p>50</p> | <p>13337</p>  <p>LARGE FLANGE</p> <p>DOMED HEAD 3/16 DIAMETER</p> <p>GRIP .251 - .375</p> <p>25</p> |
| <p>13319</p>  <p>DOMED HEAD 1/8 DIAMETER</p> <p>GRIP .065 - .125</p> <p>50</p> | <p>12260</p>  <p>DOMED HEAD 1/8 DIAMETER</p> <p>GRIP .375 - .500</p> <p>50</p> | <p>13334</p>  <p>DOMED HEAD 3/16 DIAMETER</p> <p>GRIP .376 - .500</p> <p>50</p> | <p>13338</p>  <p>LARGE FLANGE</p> <p>DOMED HEAD 3/16 DIAMETER</p> <p>GRIP .375 - .500</p> <p>25</p> |
| <p>13322</p>  <p>DOMED HEAD 1/8 DIAMETER</p> <p>GRIP .188 - .250</p> <p>50</p> | <p>39013</p>  <p>3/16 BACK-UP WASHER</p> <p>50</p> | <p>32116</p>  <p>DOMED HEAD 3/16 DIAMETER</p> <p>GRIP .625 - .750</p> <p>50</p> | <p>13338</p>  <p>LARGE FLANGE</p> <p>DOMED HEAD 3/16 DIAMETER</p> <p>GRIP .375 - .500</p> <p>25</p> |
| <p>32091</p>  <p>DOMED HEAD 1/8 DIAMETER</p> <p>GRIP .250 - .313</p> <p>50</p> | <p>13330</p>  <p>DOMED HEAD 3/16 DIAMETER</p> <p>GRIP .126 - .250</p> <p>50</p> | <p>13330</p>  <p>DOMED HEAD 3/16 DIAMETER</p> <p>GRIP .126 - .250</p> <p>50</p> | <p>13338</p>  <p>LARGE FLANGE</p> <p>DOMED HEAD 3/16 DIAMETER</p> <p>GRIP .375 - .500</p> <p>25</p> |



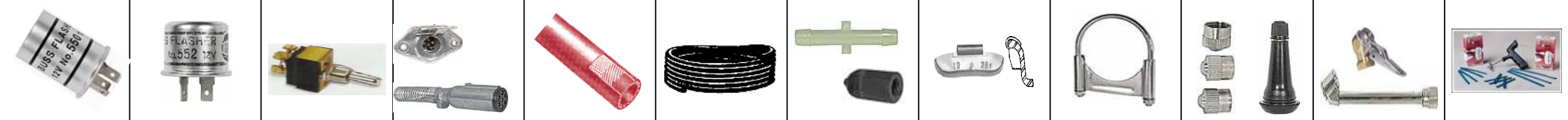











J&B Fleet - Industrial Supply

www.jbfleet.com

22428 Harrisburg-Westville Rd. Alliance, Ohio 44601 Phone: (330) 821-6342 Fax: (330) 821-0411

PART # 2062

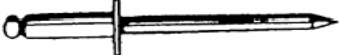
STEEL BLIND RIVETS

| | | |
|---|--|---|
| <p>13317 1</p>  <p>DOME HEAD 1/8 DIAMETER GRIP .065 - .125</p> <p>50</p> | <p>13320 2</p>  <p>DOME HEAD 1/8 DIAMETER GRIP .188 - .250</p> <p>50</p> | <p>12262 3</p>  <p>DOME HEAD 1/8 DIAMETER GRIP .313 - .375</p> <p>50</p> |
| <p>12263 4</p>  <p>DOME HEAD 1/8 DIAMETER GRIP .375 - .500</p> <p>50</p> | | <p>39010 6</p>  <p>1/8 BACK-UP WASHER</p> <p>50</p> |
| <p>32092 7</p>  <p>DOME HEAD 3/16 DIAMETER GRIP .188 - .150</p> <p>50</p> | <p>32093 8</p>  <p>DOME HEAD 3/16 DIAMETER GRIP .250 - .375</p> <p>50</p> | <p>32094 9</p>  <p>DOME HEAD 3/16 DIAMETER GRIP .375 - .500</p> <p>50</p> |
| <p>12269 10</p>  <p>LARGE FLANGE DOME HEAD 3/16 DIAMETER GRIP .375 - .500</p> <p>25</p> | | <p>39011 12</p>  <p>3/16 BACK-UP WASHER</p> <p>50</p> |





































J&B Fleet - Industrial Supply

www.jbfleet.com

22428 Harrisburg-Westville Rd. Alliance, Ohio 44601 Phone: (330) 821-6342 Fax: (330) 821-0411

PART # 2076

O-RINGS # 1

| | | | | | | | |
|---|---|--|---|---|--|---|---|
| <p>12606 ¹</p>  <p>006</p> <p>1/8 ID X 1/4 OD 15 1/16 THICK</p> | <p>12607 ²</p>  <p>007</p> <p>5/32 ID X 9/32 OD 15 1/16 THICK</p> | <p>12608 ³</p>  <p>008</p> <p>3/16 ID X 5/16 OD 15 1/16 THICK</p> | <p>12609 ⁴</p>  <p>009</p> <p>7/32 ID X 11/32 OD 15 1/16 THICK</p> | <p>12610 ⁵</p>  <p>010</p> <p>1/4 ID X 3/8 OD 15 1/16 THICK</p> | <p>12611 ⁶</p>  <p>011</p> <p>5/16 ID X 7/16 OD 15 1/16 THICK</p> | <p>12612 ⁷</p>  <p>012</p> <p>3/8 ID X 1/2 OD 15 1/16 THICK</p> | <p>39900 ⁸</p>  <p>013</p> <p>7/16 ID X 9/16 OD 10 1/16 THICK</p> |
| <p>39901 ⁹</p>  <p>014</p> <p>1/2 ID X 5/8 OD 10 1/16 THICK</p> | <p>39902 ¹⁰</p>  <p>015</p> <p>9/16 ID X 11/16 OD 10 1/16 THICK</p> | <p>39903 ¹¹</p>  <p>016</p> <p>5/8 ID X 3/4 OD 10 1/16 THICK</p> | <p>39904 ¹²</p>  <p>017</p> <p>11/16 ID X 13/16 OD 10 1/16 THICK</p> | <p>39905 ¹³</p>  <p>018</p> <p>3/4 ID X 7/8 OD 10 1/16 THICK</p> | <p>39906 ¹⁴</p>  <p>019</p> <p>13/16 ID X 15/16 OD 10 1/16 THICK</p> | <p>39907 ¹⁵</p>  <p>020</p> <p>7/8 ID X 1 OD 10 1/16 THICK</p> | <p>39908 ¹⁶</p>  <p>021</p> <p>15/16 ID X 1-1/16 OD 10 1/16 THICK</p> |
| <p>39909 ¹⁷</p>  <p>022</p> <p>1 ID X 1-1/8 OD 5 1/16 THICK</p> | <p>39910 ¹⁸</p>  <p>024</p> <p>1-1/8 ID X 1-1/4 OD 5 1/16 THICK</p> | <p>39911 ¹⁹</p>  <p>026</p> <p>1-1/4 ID X 1-3/8 OD 5 1/16 THICK</p> | <p>39912 ²⁰</p>  <p>028</p> <p>1-3/8 ID X 1-1/2 OD 5 1/16 THICK</p> | <p>39913 ²¹</p>  <p>029</p> <p>1-1/2 ID X 1-5/8 OD 5 1/16 THICK</p> | <p>39914 ²²</p>  <p>030</p> <p>1-5/8 ID X 1-3/4 OD 3 1/16 THICK</p> | <p>39915 ²³</p>  <p>031</p> <p>1-3/4 ID X 1-7/8 OD 3 1/16 THICK</p> | <p>39916 ²⁴</p>  <p>032</p> <p>1-7/8 ID X 2 OD 3 1/16 THICK</p> |
| <p>12613 ²⁵</p>  <p>110</p> <p>3/8 ID X 9/16 OD 15 3/32 THICK</p> | <p>12614 ²⁶</p>  <p>111</p> <p>7/16 ID X 5/8 OD 15 3/32 THICK</p> | <p>12615 ²⁷</p>  <p>112</p> <p>1/2 ID X 11/16 OD 15 3/32 THICK</p> | <p>12616 ²⁸</p>  <p>113</p> <p>9/16 ID X 3/4 OD 5 3/32 THICK</p> | <p>12617 ²⁹</p>  <p>114</p> <p>5/8 ID X 13/16 OD 5 3/32 THICK</p> | <p>12618 ³⁰</p>  <p>115</p> <p>11/16 ID X 7/8 OD 5 3/32 THICK</p> | <p>12619 ³¹</p>  <p>116</p> <p>3/4 ID X 15/16 OD 5 3/32 THICK</p> | <p>39940 ³²</p>  <p>117</p> <p>13/16 ID X 1 OD 5 3/32 THICK</p> |



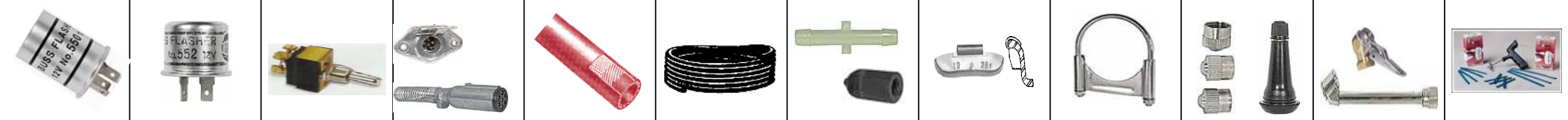

































J&B Fleet - Industrial Supply

www.jbfleet.com

22428 Harrisburg-Westville Rd. Alliance, Ohio 44601 Phone: (330) 821-6342 Fax: (330) 821-0411

PART # 2077

O-RINGS #2

| | | | | | | | |
|--|--|--|---|--|--|--|--|
|  39941 ¹ 118 7/8 ID X 1-1/16OD 10 3/32 THICK |  39942 ² 119 15/16 ID X 1-1/8OD 10 3/32 THICK |  39943 ³ 120 1 ID X 1-3/16 OD 10 3/32 THICK |  39944 ⁴ 121 1-1/16ID X 1-1/4OD 10 3/32 THICK |  39945 ⁵ 122 1-1/8ID X 1-5/16OD 10 3/32 THICK |  39946 ⁶ 123 1-3/16ID X 1-3/8O 10 3/32 THICK |  39947 ⁷ 124 1-1/4ID X 1-7/16OD 10 3/32 THICK |  39948 ⁸ 126 1-3/8ID X 1-9/16OD 5 3/32 THICK |
|  39949 ⁹ 128 1-1/2ID X 1-11/16O 5 3/32 THICK |  39950 ¹⁰ 130 1-5/8ID X 1-13/16O 5 3/32 THICK |  39951 ¹¹ 132 1-3/4ID X 1-15/16O 3 3/32 THICK |  39952 ¹² 134 1-7/8ID X 2-1/16O 3 3/32 THICK |  39953 ¹³ 146 2ID X 2-3/16OD 3 3/32 THICK |  39986 ¹⁴ 209 11/16 ID X 15/16O 10 1/8 THICK |  12620 ¹⁵ 210 3/4 ID X 1 OD 10 1/8 THICK |  12621 ¹⁶ 211 13/16ID X 1-1/16OD 10 1/8 THICK |
|  12622 ¹⁷ 212 7/8 ID X 1-1/8OD 5 1/8 THICK |  12623 ¹⁸ 213 15/16 ID X 1-3/16O 5 1/8 THICK |  12624 ¹⁹ 214 1 ID X 1-1/4 OD 5 1/8 THICK |  12625 ²⁰ 215 1-1/16ID X 1-5/16O 5 1/8 THICK |  12626 ²¹ 216 1-1/8ID X 1-3/8O 5 1/8 THICK |  12627 ²² 217 1-3/16ID X 1-7/16O 5 1/8 THICK |  12628 ²³ 218 1-1/4ID X 1-1/2OD 5 1/8 THICK |  12629 ²⁴ 219 1-5/16ID X 1-9/16O 5 1/8 THICK |
|  12630 ²⁵ 220 1-3/8ID X 1-5/8OD 5 1/8 THICK |  12631 ²⁶ 221 1-7/16ID X 1-11/16O 5 1/8 THICK |  12632 ²⁷ 222 1-1/2ID X 1-3/4OD 5 1/8 THICK |  39980 ²⁸ 223 1-5/8ID X 1-7/8OD 5 1/8 THICK |  39981 ²⁹ 224 1-3/4 ID X 2 OD 5 1/8 THICK |  39982 ³⁰ 225 1-7/8ID X 2-1/8OD 3 1/8 THICK |  39983 ³¹ 226 2 ID X 2-1/4 OD 3 1/8 THICK |  39984 ³² 227 2-1/8ID X 2-3/8OD 3 1/8 THICK |



















J&B Fleet - Industrial Supply

22428 Harrisburg-Westville Rd. Alliance, Ohio 44601 Phone: (330) 821-6342 Fax: (330) 821-0411

www.jbfleet.com

PART # 2078

O-RINGS # 3

| | | | |
|--|--|---|--|
|  39985 1 228 2-1/4 ID X 2-1/2 OD 1/8 THICK |  12633 2 325 1-1/2 ID X 1-7/8 OD 3/16 THICK |  12634 3 326 1-5/8 ID X 2 OD 3/16 THICK |  12635 4 327 1-3/4 ID X 2-1/8 OD 3/16 THICK |
|  13448 5 328 1-7/8 ID X 2-1/4 OD 3/16 THICK |  13449 6 329 2 ID X 2-3/8 OD 3/16 THICK |  13450 7 330 2-1/8 ID X 2-1/2 OD 3/16 THICK |  13451 8 331 2-1/4 ID X 2-5/8 OD 3/16 THICK |
|  13452 9 332 2-3/8 ID X 2-3/4 OD 3/16 THICK |  13453 10 333 2-1/2 ID X 2-7/8 OD 3/16 THICK |  13454 11 334 2-5/8 ID X 3 OD 3/16 THICK |  13455 12 335 2-3/4 ID X 3-1/8 OD 3/16 THICK |
|  13456 13 336 2-7/8 ID X 3-1/4 OD 3/16 THICK |  13457 14 337 3 ID X 3-3/8 OD 3/16 THICK | 15 | 16 |

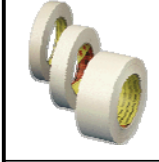



J&B Fleet - Industrial Supply

































22428 Harrisburg-Westville Rd. Alliance, Ohio 44601 Phone: (330) 821-6342 Fax: (330) 821-0411

www.jbfleet.com

PART # 2030

O-RINGS #4

pictures not actual size

| | | | | | | | |
|--|---|---|---|---|---|--|--|
| <p>12606 ¹</p>  <p>006</p> <p>1/8 ID X 1/4 OD 15 1/16 THICK</p> | <p>12607 ²</p>  <p>007</p> <p>5/32 ID X 9/32 OD 15 1/16 THICK</p> | <p>12608 ³</p>  <p>008</p> <p>3/16 ID X 5/16 OD 15 1/16 THICK</p> | <p>12609 ⁴</p>  <p>009</p> <p>7/32 ID X 11/32 OD 15 1/16 THICK</p> | <p>12610 ⁵</p>  <p>010</p> <p>1/4 ID X 3/8 OD 15 1/16 THICK</p> | <p>12611 ⁶</p>  <p>011</p> <p>5/16 ID X 7/16 OD 15 1/16 THICK</p> | <p>12612 ⁷</p>  <p>012</p> <p>3/8 ID X 1/2 OD 15 1/16 THICK</p> | <p>39900 ⁸</p>  <p>013</p> <p>7/16 ID X 9/16 OD 15 1/16 THICK</p> |
| <p>39901 ⁹</p>  <p>014</p> <p>1/2 ID X 5/8 OD 10 1/16 THICK</p> | <p>39902 ¹⁰</p>  <p>015</p> <p>9/16 ID X 11/16 OD 10 1/16 THICK</p> | <p>12613 ¹¹</p>  <p>110</p> <p>3/8 ID X 9/16 OD 10 3/32 THICK</p> | <p>12614 ¹²</p>  <p>111</p> <p>7/16 ID X 5/8 OD 10 3/32 THICK</p> | <p>12615 ¹³</p>  <p>112</p> <p>1/2 ID X 11/16 OD 10 3/32 THICK</p> | <p>12616 ¹⁴</p>  <p>113</p> <p>9/16 ID X 3/4 OD 10 3/32 THICK</p> | <p>12617 ¹⁵</p>  <p>114</p> <p>5/8 ID X 13/16 OD 10 3/32 THICK</p> | <p>39940 ¹⁶</p>  <p>115</p> <p>11/16 ID X 7/8 OD 5 3/32 THICK</p> |
| <p>12618 ¹⁷</p>  <p>115</p> <p>11/16 ID X 7/8 OD 5 3/32 THICK</p> | <p>12619 ¹⁸</p>  <p>116</p> <p>3/4 ID X 15/16 OD 5 3/32 THICK</p> | <p>39941 ¹⁹</p>  <p>117</p> <p>13/16 ID X 1 OD 5 3/32 THICK</p> | <p>39942 ²⁰</p>  <p>118</p> <p>7/8 ID X 1-1/16 OD 5 3/32 THICK</p> | <p>39943 ²¹</p>  <p>119</p> <p>15/16 ID X 1-1/8 OD 5 3/32 THICK</p> | <p>39944 ²²</p>  <p>120</p> <p>1 ID X 1-3/16 OD 5 3/32 THICK</p> | <p>39944 ²³</p>  <p>121</p> <p>1-1/16 ID X 1-1/4 OD 5 3/32 THICK</p> | <p>39944 ²⁴</p>  <p>122</p> <p>1 ID X 1-3/16 OD 5 3/32 THICK</p> |
| <p>39986 ²⁵</p>  <p>209</p> <p>11/16 ID X 15/16 OD 5 1/8 THICK</p> | <p>12620 ²⁶</p>  <p>210</p> <p>3/4 ID X 1 OD 5 1/8 THICK</p> | <p>12621 ²⁷</p>  <p>211</p> <p>13/16 ID X 1-1/16 OD 5 1/8 THICK</p> | <p>12622 ²⁸</p>  <p>212</p> <p>7/8 ID X 1-1/8 OD 5 1/8 THICK</p> | <p>12623 ²⁹</p>  <p>213</p> <p>15/16 ID X 1-3/16 OD 5 1/8 THICK</p> | <p>12624 ³⁰</p>  <p>214</p> <p>1 ID X 1-1/4 OD 5 1/8 THICK</p> | <p>12625 ³¹</p>  <p>215</p> <p>1-1/16 ID X 1-5/16 OD 5 1/8 THICK</p> | <p>12626 ³²</p>  <p>216</p> <p>1-1/8 ID X 1-3/8 OD 5 1/8 THICK</p> |



























J&B Fleet - Industrial Supply

22428 Harrisburg-Westville Rd. Alliance, Ohio 44601 Phone: (330) 821-6342 Fax: (330) 821-0411

www.jbfleet.com

PART # 2031

O-RINGS #5

| | | | | | |
|---|--|---|---|---|---|
| <p>12627 ¹</p>  <p>217</p> <p>1-3/16 ID X 1-7/16 OD</p> <p>5 1/8 THICK</p> | <p>12628 ²</p>  <p>218</p> <p>1-1/4 ID X 1-1/2 OD</p> <p>5 1/8 THICK</p> | <p>12629 ³</p>  <p>219</p> <p>1-5/16 ID X 1-9/16 OD</p> <p>5 1/8 THICK</p> | <p>12630 ⁴</p>  <p>220</p> <p>1-3/8 ID X 1-5/8 OD</p> <p>5 1/8 THICK</p> | <p>12631 ⁵</p>  <p>221</p> <p>1-7/16 ID X 1-11/16 OD</p> <p>5 1/8 THICK</p> | <p>13453 ⁶</p>  <p>333</p> <p>2-1/2 ID X 2-7/8 OD</p> <p>3 3/16 THICK</p> |
| <p>12632 ⁷</p>  <p>222</p> <p>1-1/2 ID X 1-3/4 OD</p> <p>5 1/8 THICK</p> | <p>39980 ⁸</p>  <p>223</p> <p>1-5/8 ID X 1-7/8 OD</p> <p>5 1/8 THICK</p> | <p>39981 ⁹</p>  <p>224</p> <p>1-3/4 ID X 2 OD</p> <p>5 1/8 THICK</p> | <p>39982 ¹⁰</p>  <p>225</p> <p>1-7/8 ID X 2-1/8 OD</p> <p>5 1/8 THICK</p> | <p>39983 ¹¹</p>  <p>226</p> <p>2 ID X 2-1/4 OD</p> <p>3 1/8 THICK</p> | <p>13454 ¹²</p>  <p>334</p> <p>2-5/8 ID X 3 OD</p> <p>3 3/16 THICK</p> |
| <p>39984 ¹³</p>  <p>227</p> <p>2-1/8 ID X 2-3/8 OD</p> <p>3 1/8 THICK</p> | <p>39985 ¹⁴</p>  <p>228</p> <p>2-1/4 ID X 2-1/2 OD</p> <p>3 1/8 THICK</p> | <p>12633 ¹⁵</p>  <p>325</p> <p>1-1/2 ID X 1-7/8 OD</p> <p>5 3/16 THICK</p> | <p>12634 ¹⁶</p>  <p>326</p> <p>1-5/8 ID X 2 OD</p> <p>5 3/16 THICK</p> | <p>12635 ¹⁷</p>  <p>327</p> <p>1-3/4 ID X 2-1/8 OD</p> <p>5 3/16 THICK</p> | <p>13455 ¹⁸</p>  <p>335</p> <p>2-3/4 ID X 3-1/8 OD</p> <p>3 3/16 THICK</p> |
| <p>13448 ¹⁹</p>  <p>328</p> <p>1-7/8 ID X 2-1/4 OD</p> <p>5 3/16 THICK</p> | <p>13449 ²⁰</p>  <p>329</p> <p>2 ID X 2-3/8 OD</p> <p>5 3/16 THICK</p> | <p>13450 ²¹</p>  <p>330</p> <p>2-1/8 ID X 2-1/2 OD</p> <p>5 3/16 THICK</p> | <p>13451 ²²</p>  <p>331</p> <p>2-1/4 ID X 2-5/8 OD</p> <p>3 3/16 THICK</p> | <p>13452 ²³</p>  <p>332</p> <p>2-3/8 ID X 2-3/4 OD</p> <p>3 3/16 THICK</p> | <p>24</p> |

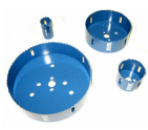
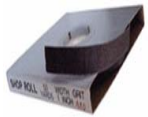

LET US HELP YOU MAKE THE CONNECTION

PART # 3017



O-RINGS



J & B FLEET-INDUSTRIAL SUPPLY
PHONE: 330-821-6342

| | | | | | |
|--|---|--|---|--|---|
| 12607 9/32 OD 1/16 THICK 25 | 12608 5/16 OD 1/16 THICK 25 | 12609 11/32 OD 1/16 THICK 25 | 12610 3/8 OD 1/16 THICK 25 | 12611 7/16 OD 1/16 THICK 25 | 12612 1/2 OD 1/16 THICK 25 |
| 12613 9/16 OD 3/32 THICK 25 | 12614 5/8 OD 3/32 THICK 25 | 12615 11/16 OD 3/32 THICK 25 | 12616 3/4 OD 3/32 THICK 10 | 12617 13/16 OD 3/32 THICK 10 | 12618 7/8 OD 3/32 THICK 10 |
| 12619 15/16 OD 3/32 THICK 10 | 12620 1" OD 1/8 THICK 10 | 12621 1-1/16 OD 1/8 THICK 10 | 12622 1-1/8 OD 1/8 THICK 10 | 12623 1-3/16 OD 1/8 THICK 10 | 12624 1-1/4 OD 1/8 THICK 10 |

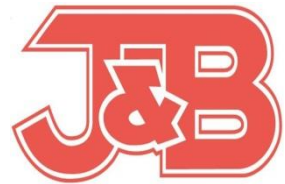
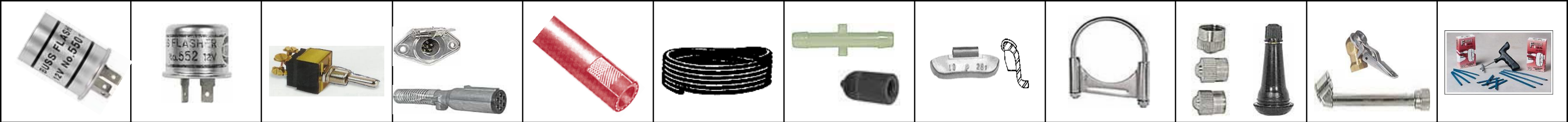









J&B Fleet - Industrial Supply

22428 Harrisburg-Westville Rd. Alliance, Ohio 44601 Phone: (330) 821-6342 Fax: (330) 821-0411

www.jbfleet.com

O-RING FACE SEAL O-RING 90 DUROMETER NITRILE

PART # 2810

| | | | |
|---|---|---|--|
| <p>56230</p>  <p>-4 1/4" END SIZE</p> <p>10</p> | <p>56233</p>  <p>-10 5/8" END SIZE</p> <p>10</p> | <p>56236</p>  <p>-16 1" END SIZE</p> <p>5</p> | |
| <p>56231</p>  <p>-6 3/8" END SIZE</p> <p>10</p> | <p>56234</p>  <p>-12 3/4" END SIZE</p> <p>5</p> | <p>56237</p>  <p>-20 1-1/4" END SIZE</p> <p>5</p> | |
| <p>56232</p>  <p>-8 1/2" END SIZE</p> <p>10</p> | <p>56235</p>  <p>-14 7/8" END SIZE</p> <p>5</p> | <p>56238</p>  <p>-24 1-1/2" END SIZE</p> <p>5</p> | |



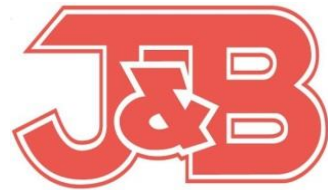
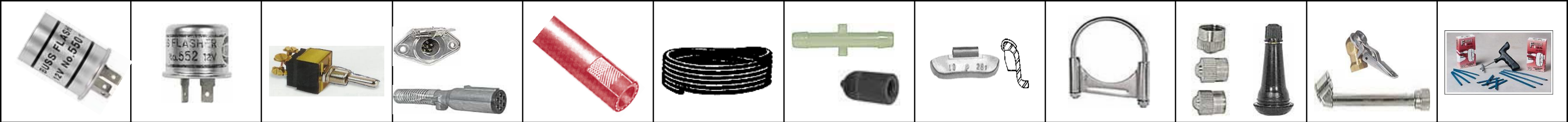









J&B Fleet - Industrial Supply

22428 Harrisburg-Westville Rd. Alliance, Ohio 44601 Phone: (330) 821-6342 Fax: (330) 821-0411

www.jbfleet.com

**SAE STRAIGHT THREAD PORT O-RINGS
90 DUROMETER NITRILE**

PART # 2811

| | | | |
|---|---|--|--|
| <p>56260</p>  <p>-4 1/4" END SIZE</p> <p>20</p> | <p>56266</p>  <p>-8 1/2" END SIZE</p> <p>15</p> | <p>56272</p>  <p>-16 1" END SIZE</p> <p>10</p> | |
| <p>56262</p>  <p>-5 5/16" END SIZE</p> <p>20</p> | <p>56268</p>  <p>-10 5/8" END SIZE</p> <p>10</p> | <p>56274</p>  <p>-20 1-1/4" END SIZE</p> <p>5</p> | |
| <p>56264</p>  <p>-6 3/8" END SIZE</p> <p>20</p> | <p>56270</p>  <p>-12 3/4" END SIZE</p> <p>10</p> | | |

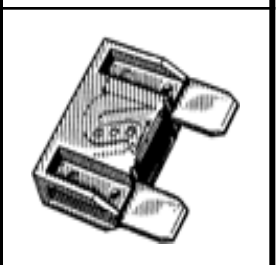

O-RING ASSORTMENTS

METRIC

- Convenient re-sealable plastic case.
- 419 o-rings. 32 sizes.

| I/D | Section | I/D | Section |
|-----|---------|------|---------|
| 3 | 1.5mm | 20 | 3.5mm |
| 4.4 | 2.0mm | 22 | 3.5mm |
| 5 | 2.0mm | 23.5 | 3.5mm |
| 7 | 1.5mm | 25 | 3.5mm |
| 10 | 1.5mm | 26.5 | 3.5mm |
| 13 | 1.5mm | 28 | 3.5mm |
| 10 | 2.5mm | 30 | 3.5mm |
| 11 | 2.5mm | 31 | 3.5mm |
| 13 | 2.5mm | 33 | 3.5mm |
| 14 | 2.5mm | 34.5 | 3.5mm |
| 16 | 2.5mm | 36 | 3.5mm |
| 18 | 2.5mm | 38 | 3.5mm |
| 19 | 2.5mm | 41 | 3.5mm |
| 21 | 2.5mm | 44 | 3.5mm |
| 22 | 2.5mm | 47 | 3.5mm |
| 18 | 3.5mm | 50 | 3.5mm |



J&B #

2072

STANDARD

- Convenient re-sealable plastic case.
- 382 o-rings. 30 sizes.

| I/D | Section | I/D | Section |
|-------|---------|--------|---------|
| 1/8 | 1/16 | 13/16 | 1/8 |
| 5/32 | 1/16 | 7/8 | 1/8 |
| 3/16 | 1/16 | 15/16 | 1/8 |
| 7/32 | 1/16 | 1" | 1/8 |
| 1/4 | 1/16 | 1-1/16 | 1/8 |
| 5/16 | 1/16 | 1-1/8 | 1/8 |
| 3/8 | 1/16 | 1-3/16 | 1/8 |
| 3/8 | 3/32 | 1-1/4 | 1/8 |
| 7/16 | 3/32 | 1-5/16 | 1/8 |
| 1/2 | 3/32 | 1-3/8 | 1/8 |
| 9/16 | 3/32 | 1-7/16 | 1/8 |
| 5/8 | 3/32 | 1-1/2 | 1/8 |
| 11/16 | 3/32 | 1-1/2 | 3/16 |
| 3/4 | 3/32 | 1-5/8 | 3/16 |
| 3/4 | 1/8 | 1-3/4 | 3/16 |



J&B #

2071

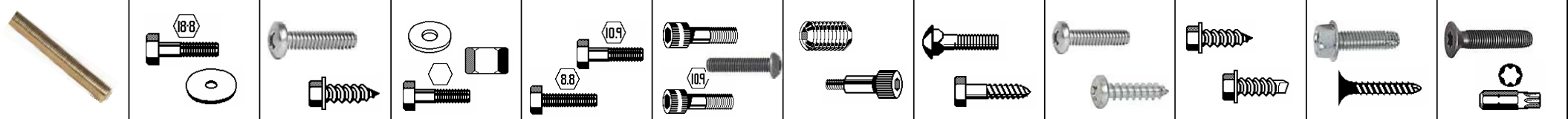

























J&B Fleet - Industrial Supply

22428 Harrisburg-Westville Rd. Alliance, Ohio 44601 Phone: (330) 821-6342 Fax: (330) 821-0411

www.jbfleet.com

PART # 2220

RUBBER GROMMETS

| | | | | | |
|---|---|---|--|---|---|
| <p>38201 ¹</p>  <p>1/8 BORE 3/32 GROOVE 1/2 OD 5/16 THICKNESS</p> <p>5</p> | <p>38172 ²</p>  <p>5/32 BORE 1/16 GROOVE 3/8 OD 3/16 THICKNESS</p> <p>5</p> | <p>38202 ³</p>  <p>3/16 BORE 1/16 GROOVE 1/2 OD 1/4 THICKNESS</p> <p>5</p> | <p>38173 ⁴</p>  <p>3/16 BORE 1/4 GROOVE 7/16 OD 3/8 THICKNESS</p> <p>5</p> | <p>38204 ⁵</p>  <p>1/4 BORE 1/4 GROOVE 5/8 OD 3/16 THICKNESS</p> <p>5</p> | <p>38205 ⁶</p>  <p>1/4 BORE 1/4 GROOVE 1-1/4 OD 1/4 THICKNESS</p> <p>5</p> |
| <p>38206 ⁷</p>  <p>5/16 BORE 1/16 GROOVE 13/16 OD 5/16 THICKNESS</p> <p>5</p> | <p>38207 ⁸</p>  <p>5/16 BORE 1/8 GROOVE 13/16 OD 3/8 THICKNESS</p> <p>5</p> | <p>38208 ⁹</p>  <p>5/16 BORE 1/4 GROOVE 13/16 OD 1/2 THICKNESS</p> <p>5</p> | <p>38209 ¹⁰</p>  <p>3/8 BORE 1/16 GROOVE 5/8 OD 9/32 THICKNESS</p> <p>5</p> | <p>38210 ¹¹</p>  <p>3/8 BORE 1/16 GROOVE 1-1/4 OD 1/4 THICKNESS</p> <p>5</p> | <p>38211 ¹²</p>  <p>5</p> |
| <p>38213 ¹³</p>  <p>1/2 BORE 3/32 GROOVE 31/32 OD 9/32 THICKNESS</p> <p>5</p> | <p>38216 ¹⁴</p>  <p>1/2 BORE 1/4 GROOVE 1-1/16 OD 1/2 THICKNESS</p> <p>5</p> | <p>38217 ¹⁵</p>  <p>5/8 BORE 1/8 GROOVE 1-1/8 OD 3/8 THICKNESS</p> <p>5</p> | <p>38218 ¹⁶</p>  <p>5/8 BORE 1/16 GROOVE 1-1/8 OD 5/16 THICKNESS</p> <p>5</p> | <p>38219 ¹⁷</p>  <p>5</p> | <p>38220 ¹⁸</p>  <p>5</p> |
| <p>38220 ¹⁹</p>  <p>3/4 BORE 1/16 GROOVE 1-3/8 OD 3/8 THICKNESS</p> <p>5</p> | <p>38221 ²⁰</p>  <p>5</p> | <p>38221 ²¹</p>  <p>3/4 BORE 1/16 GROOVE 1-5/8 OD 1/4 THICKNESS</p> <p>5</p> | <p>38222 ²²</p>  <p>5</p> | <p>38222 ²³</p>  <p>3/4 BORE 1/4 GROOVE 1-5/8 OD 7/16 THICKNESS</p> <p>5</p> | <p>38223 ²⁴</p>  <p>5</p> |

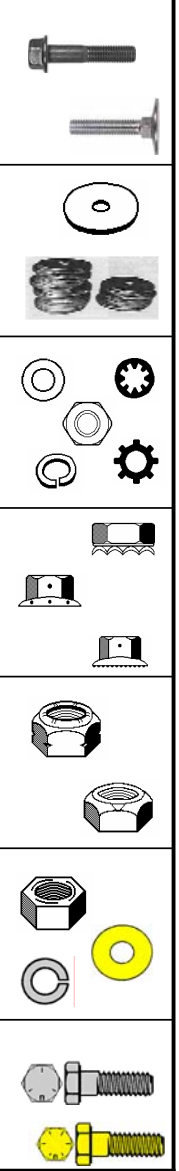

LET US HELP YOU MAKE THE CONNECTION

PART # 3035



GROMMETS



J & B FLEET-INDUSTRIAL SUPPLY
PHONE: 330-821-6342

| | | | | | |
|---|---|---|--|--|--|
| <p>38201</p> <p>1/8 BORE 3/32 GROOVE 1/2 OD 5/16 THICKNESS</p> <p>5</p> | <p>38172</p> <p>5/32 BORE 1/16 GROOVE 3/8 OD 3/16 THICKNESS</p> <p>5</p> | <p>38202</p> <p>3/16 BORE 1/16 GROOVE 1/2 OD 1/4 THICKNESS</p> <p>5</p> | <p>38173</p> <p>3/16 BORE 1/4 GROOVE 7/16 OD 3/8 THICKNESS</p> <p>5</p> | <p>38204</p> <p>1/4 BORE 1/4 GROOVE 7/16 OD 3/16 THICKNESS</p> <p>5</p> | <p>38205</p> <p>1/4 BORE 1/4 GROOVE 1-1/4 OD 1/4 THICKNESS</p> <p>5</p> |
| <p>38206</p> <p>5/16 BORE 1/16 GROOVE 13/16 OD 5/16 THICKNESS</p> <p>5</p> | <p>38207</p> <p>5/16 BORE 1/8 GROOVE 13/16 OD 3/8 THICKNESS</p> <p>5</p> | <p>38208</p> <p>5/16 BORE 1/4 GROOVE 13/16 OD 1/2 THICKNESS</p> <p>5</p> | <p>38209</p> <p>3/8 BORE 1/16 GROOVE 5/8 OD 9/32 THICKNESS</p> <p>5</p> | <p>38213</p> <p>1/2 BORE 3/32 GROOVE 31/32 OD 9/32 THICKNESS</p> <p>5</p> | |

























J&B Fleet - Industrial Supply

22428 Harrisburg-Westville Rd. Alliance, Ohio 44601 Phone: (330) 821-6342 Fax: (330) 821-0411

www.jbfleet.com

PART # 2068

INTERNAL RETAINING RINGS

| | | | | | |
|---|--|---|---|---|---|
|  10638 1 10 1/4 |  10642 2 10 1/2 |  10645 3 15 3/4 |  40032 4 5 1-1/16 |  40046 6 2 1-7/16 | |
|  10639 7 10 5/16 |  10643 8 10 9/16 |  40031 9 10 13/16 |  10648 10 5 1-1/8 |  40047 12 2 1-1/2 | |
|  10640 13 10 3/8 |  10644 14 10 5/8 |  10646 15 10 7/8 |  40033 16 5 1-3/16 |  40044 17 2 1-5/16 |  40048 18 2 1-5/8 |
|  10641 19 10 7/16 |  40030 20 10 11/16 |  10647 21 10 1" |  10649 22 5 1-1/4 |  40045 23 2 1-3/8 |  40049 24 2 1-3/4 |





































J&B Fleet - Industrial Supply

22428 Harrisburg-Westville Rd. Alliance, Ohio 44601 Phone: (330) 821-6342 Fax: (330) 821-0411

www.jbfleet.com

PART # 2036

RETAINING RINGS

| | | | | | | | |
|--|--|--|---|---|--|--|--|
| <p>10638 ¹</p>  <p>20 1/4</p> | <p>10639 ²</p>  <p>20 5/16</p> | <p>10640 ³</p>  <p>20 3/8</p> | <p>10641 ⁴</p>  <p>15 7/16</p> | <p>10642 ⁵</p>  <p>15 1/2</p> | <p>10643 ⁶</p>  <p>10 9/16</p> | <p>10644 ⁷</p>  <p>10 5/8</p> | <p>10645 ⁸</p>  <p>5 3/4</p> |
| <p>10646 ⁹</p>  <p>5 7/8</p> | <p>10647 ¹⁰</p>  <p>5 1</p> | <p>10648 ¹¹</p>  <p>3 1-1/8</p> | <p>10649 ¹²</p>  <p>3 1-1/4</p> | <p>40044 ¹³</p>  <p>3 1-5/16</p> | <p>40045 ¹⁴</p>  <p>3 1-3/8</p> | <p>40047 ¹⁵</p>  <p>3 1-1/2</p> | <p>40049 ¹⁶</p>  <p>2 1-3/4</p> |
| <p>10650 ¹⁷</p>  <p>20 1/4</p> | <p>10651 ¹⁸</p>  <p>20 5/16</p> | <p>10652 ¹⁹</p>  <p>20 3/8</p> | <p>10653 ²⁰</p>  <p>15 7/16</p> | <p>10654 ²¹</p>  <p>15 1/2</p> | <p>10655 ²²</p>  <p>10 9/16</p> | <p>10656 ²³</p>  <p>10 5/8</p> | <p>10657 ²⁴</p>  <p>5 3/4</p> |
| <p>10658 ²⁵</p>  <p>5 7/8</p> | <p>10659 ²⁶</p>  <p>5 1</p> | <p>10660 ²⁷</p>  <p>3 1-1/8</p> | <p>10661 ²⁸</p>  <p>3 1-1/4</p> | <p>40060 ²⁹</p>  <p>3 1-5/16</p> | <p>40061 ³⁰</p>  <p>3 1-3/8</p> | <p>40063 ³¹</p>  <p>3 1-1/2</p> | <p>40065 ³²</p>  <p>2 1-3/4</p> |



LET US HELP YOU MAKE THE CONNECTION

PART # 3013



INTERNAL SNAP RINGS



J & B FLEET-INDUSTRIAL SUPPLY
PHONE: 330-821-6342

| | | | | | |
|-------------------------------------|------------------------------------|-------------------------------------|------------------------------------|-------------------------------------|------------------------------------|
| 10638 1/4" 10 | 10639 5/16" 10 | 10640 3/8" 10 | 10641 7/16" 5 | 10642 1/2" 5 | 10643 9/16" 4 |
| 10644 5/8" 4 | 40030 11/16" 4 | 10645 3/4" 4 | 40031 13/16" 4 | 10646 7/8" 4 | 10647 1" 4 |
| 40032 1-1/16" 2 | 10648 1-1/8" 2 | 40033 1-3/16" 2 | 10649 1-1/4" 2 | 40044 1-5/16" 2 | 40045 1-3/8" 2 |

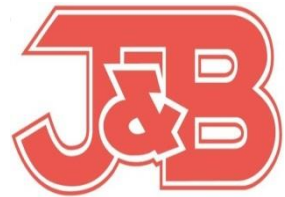

































J&B Fleet - Industrial Supply

22428 Harrisburg-Westville Rd. Alliance, Ohio 44601 Phone: (330) 821-6342 Fax: (330) 821-0411

www.jbfleet.com

EXTERNAL RETAINING RINGS

PART # 2066

| | | | | | | | |
|---|--|---|---|--|--|---|---|
|  87000 1 10 1/8" |  10651 2 10 5/16" |  10653 3 10 7/16" |  10762 4 5 11/16" |  87003 5 5 15/16" |  40059 6 3 1-3/16" |  40062 7 3 1-7/16" |  87004 8 2 1-7/8" |
|  40055 9 10 3/16" |  40057 10 10 11/32" |  10654 11 10 1/2" |  10657 12 10 3/4" |  10659 13 5 1" |  10661 14 3 1-1/4" |  40063 15 2 1-1/2" |  40066 16 2 2" |
|  10650 17 20 1/4" |  10652 18 10 3/8" |  10655 19 10 9/16" |  87002 20 5 13/16" |  40058 21 5 1-1/16" |  40060 22 3 1-5/16" |  40064 23 2 1-5/8" |  87006 24 2 2-1/4" |
|  40056 25 10 9/32" |  87001 26 10 13/32" |  10656 27 10 5/8" |  10658 28 5 7/8" |  10660 29 5 1-1/8" |  40061 30 3 1-3/8" |  40065 31 2 1-3/4" |  87008 32 2 2-1/2" |

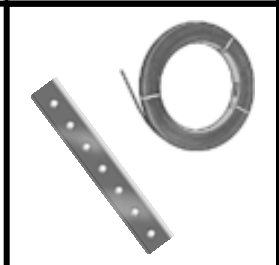

LET US HELP YOU MAKE THE CONNECTION

PART # 3009



RETAINING RINGS



J & B FLEET-INDUSTRIAL SUPPLY
PHONE: 330-821-6342

| | | | | | |
|--|---|--|--|---|--|
| 10650 1/4" External 10 | 10651 5/16" External 10 | 10652 3/8" External 10 | 10653 7/16" External 5 | 10654 1/2" External 5 | 10655 9/16" External 4 |
| 10656 5/8" External 4 | 10657 3/4" External 4 | 10659 1" External 4 | 10638 1/4" Internal 10 | 10639 5/16" Internal 10 | 10640 3/8" Internal 10 |
| 10641 7/16" Internal 5 | 10642 1/2" Internal 5 | 10643 9/16" Internal 4 | 10644 5/8" Internal 4 | 10645 3/4" Internal 4 | 10647 1" Internal 4 |

LET US HELP YOU MAKE THE CONNECTION

PART # 3011



EXTERNAL SNAP RINGS



J & B FLEET-INDUSTRIAL SUPPLY
PHONE: 330-821-6342

| | | | | | |
|--------------------------------------|-------------------------------------|--------------------------------------|-------------------------------------|--------------------------------------|-------------------------------------|
| 10650 1/4" 10 | 40056 9/32" 10 | 10651 5/16" 10 | 40057 11/32" 5 | 10652 3/8" 5 | 10653 7/16" 4 |
| 10654 1/2" 4 | 10655 9/16" 4 | 10656 5/8" 4 | 10657 3/4" 4 | 10658 7/8" 4 | 10659 1" 4 |
| 40058 1-1/16" 2 | 10660 1-1/8" 2 | 40059 1-3/16" 2 | 10661 1-1/4" 2 | 40060 1-5/16" 2 | 40061 1-3/8" 2 |

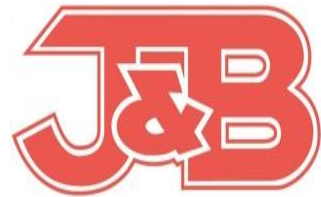





















J&B Fleet - Industrial Supply

www.jbfleet.com

22428 Harrisburg-Westville Rd. Alliance, Ohio 44601 Phone: (330) 821-6342 Fax: (330) 821-0411

PART # 2039

RETAINING RINGS

| | | | | | | | |
|---|---|---|---|--|---|--|--|
| <p>12706 ¹</p>  <p>25 1/16"</p> | <p>12711 ²</p>  <p>25 3/32"</p> | <p>12712 ³</p>  <p>25 1/8"</p> | <p>12707 ⁴</p>  <p>25 9/64"</p> | <p>12713 ⁵</p>  <p>25 5/32"</p> | <p>12708 ⁶</p>  <p>25 11/64"</p> | <p>12714 ⁷</p>  <p>25 3/16"</p> | <p>12717 ⁸</p>  <p>25 7/32"</p> |
| <p>12715 ⁹</p>  <p>25 1/4"</p> | <p>12716 ¹⁰</p>  <p>25 5/16"</p> | <p>10951 ¹¹</p>  <p>25 3/8"</p> | <p>12718 ¹²</p>  <p>25 7/16"</p> | <p>12719 ¹³</p>  <p>25 1/2"</p> | <p>12768 ¹⁴</p>  <p>25 9/16"</p> | <p>11094 ¹⁵</p>  <p>25 5/8"</p> | <p>11095 ¹⁶</p>  <p>25 3/4"</p> |
| <p>11096 ¹⁷</p>  <p>20 7/8"</p> | <p>11097 ¹⁸</p>  <p>20 1"</p> | <p>12709 ¹⁹</p>  <p>20 1-3/16"</p> | <p>12710 ²⁰</p>  <p>20 1-3/8"</p> | <p>²¹</p> | <p>²²</p> | <p>²³</p> | <p>²⁴</p> |
| <p>²⁵</p> | <p>²⁶</p> | <p>²⁷</p> | <p>²⁸</p> | <p>²⁹</p> | <p>³⁰</p> | <p>³¹</p> | <p>³²</p> |

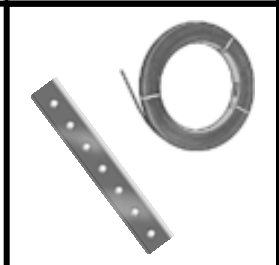

LET US HELP YOU MAKE THE CONNECTION

PART # 3015



E - RINGS



J & B FLEET-INDUSTRIAL SUPPLY
PHONE: 330-821-6342

| | | | | | |
|------------------------------------|------------------------------------|-----------------------------------|------------------------------------|------------------------------------|-------------------------------------|
| 12706 1/16" 20 | 12711 3/32" 20 | 12712 1/8" 20 | 12707 9/64" 20 | 12713 5/32" 20 | 12708 11/64" 15 |
| 12714 3/16" 15 | 12717 7/32" 15 | 12715 1/4" 15 | 12716 5/16" 10 | 10951 3/8" 10 | 12718 7/16" 10 |
| 12719 1/2" 10 | 12768 9/16" 5 | 11094 5/8" 5 | 11095 3/4" 5 | 11096 7/8" 5 | 11097 1" 5 |