

WIRE

GENERAL PURPOSE PRIMARY WIRE

- Plastic insulated primary wire is standard for original equipment and replacement on all equipment.
- Because of its smooth surface it is ideal for pulling through loom or conduit.
- Thermoplastic insulation operates satisfactorily between the extreme temperatures of -30F and +176F.
- It is highly resistant to grease, oil, and acids and is available in bright colors for easy identification.
- For use on 60 volts or less. Meets SAE J1128 specifications. RoHS compliant.

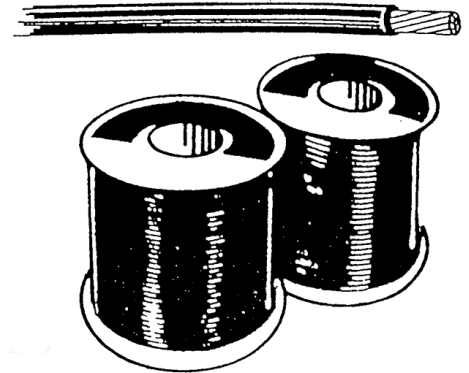

100 FOOT ROLLS

COLOR	8 GA	10 GA	12 GA	14 GA	16 GA	18 GA	20 GA
BLUE		22543	22550	22557	22564	22571	22600
YELLOW		22544	22551	22558	22565	22572	22601
RED	22599	22549	22556	22563	22570	22577	22602
BLACK	22598	22545	22552	22559	22566	22573	22603
GREEN		22546	22553	22560	22567	22574	22604
WHITE		22547	22554	22561	22568	22575	22605
BROWN		22548	22555	22562	22569	22576	22606
ORANGE				22584	22588		
PURPLE				22585*	22589*		

* Purple wire rated at 221F.

WIRE STORAGE RACK - PAGE 2006

1000 FOOT ROLLS

COLOR	8 GA	10 GA	12 GA	14 GA	16 GA	18 GA
BLUE				40920		
YELLOW				40921		
BLACK				40922	39356	
GREEN				40923		
WHITE				40924		
BROWN				40925		
RED				40926	39360	











WIRE TERMINALS

NYLON SOLDERLESS TERMINALS

Nylon Insulated Support Sleeve

22-18 Wire Range (Red)

- Reinforced butted seam with funnel entry.
- Vibration resistant with high temperature range.

J&B #	QTY	STUD SIZE	
21888	50	4-6	
21889	50	4-6	
41240	100	8-10	
21891	50	8-10	
21897	25	8-10	
21895	25	4-6	
21900	25	4-6	
21901	25	8-10	
41244	100	BUTT	
21903	50	BUTT	
24763	50	F-QUICK 3/16	
39183	25	1/4	
24764	50	M-QUICK 3/16	
39184	25	1/4	
45708	25	16-14 to 22-18 STEP DOWN	















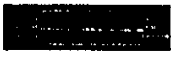

WIRE TERMINALS

NYLON SOLDERLESS TERMINALS

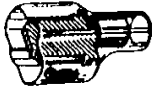
Nylon Insulated Support Sleeve

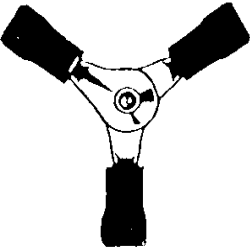
16-14 Wire Range (Blue)

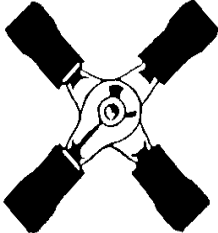
- Reinforced butted seam with funnel entry.
- Vibration resistant with high temperature range.

J&B #	QTY	STUD SIZE		J&B #	QTY	STUD SIZE	
21906	50	4-6		21918	25	4-6	
21907	50	4-6		21919	25	8-10	
21908	50	6-8		41260	100	BUTT	
41250	100	8-10		21921	50	BUTT	
21909	50	8-10			41264	100	1/4
41251	100	12-1/4		21952	25	1/4	
21910	25	12-1/4			41265	100	1/4
41252	100	1/4-5/16		24766	50	F-QUICK 3/16	
21911	25	1/4-5/16			41268	100	
21905	25	1/4-5/16		22291	25	1/4	
21912	25	5/16-3/8		24767	50	M-QUICK 3/16	
21913	25	4-6		41269	100	1/4	
41256	100	8-10		22290	25	1/4	
21915	25	8-10			21922	10	
21916	25	4-6		21923	5	4-WAY	
21920	25	4-6		45709	25	12-10 to 16-14 STEP DOWN	
41258	100	8-10					
21917	25	8-10					
45708	25	16-14 to 22-18 STEP DOWN					























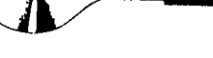



WIRE TERMINALS

NYLON SOLDERLESS TERMINALS

Nylon Insulated Support Sleeve

12-10 **Wire Range (Yellow)**

- Reinforced butted seam with funnel entry.
- Vibration resistant with high temperature range.

J&B #	QTY	STUD SIZE		J&B #	QTY	STUD SIZE	
21924	25	4-6		21939	25	4-6	
21925	25	4-6		21940	25	8-10	
21926	25	6-8		41280	100	BUTT	
21927	25	6-8		21942	25	BUTT	
41274	100	8-10		21935	25	4-6	
21928	25	8-10			21936	25	8-10
41275	100	12-1/4		21937	25	4-6	
21929	25	12-1/4			21938	25	8-10
21930	25	1/4-5/16		41284	100	F-QUICK	
21931	25	1/4-5/16		39185	25	F-QUICK	
21932	20	5/16-3/8		41285	100	M-QUICK	
21934	10	7/16-1/2		39186	25	M-QUICK	
				21953	25	1/4	
				21951	25	1/4	
				45709	25	12-10 to 16-14 STEP DOWN	
							
							
							
							
							











WIRE TERMINALS









P.V.C. PLASTIC SOLDERLESS TERMINALS

P.V.C. Plastic Insulating Sleeve

22-18 Wire Range (Red)

- Butted seam with funnel entry.

J&B #	QTY	STUD SIZE	
20692	50	4-6	
20693	50	4-6	
24727	100	8-10	
20694	50	8-10	
20691	50	12-1/4	
20704	25	5/16	
20624	25	4-6	
20625	25	8-10	
20714	25	4-6	
20715	25	8-10	

J&B #	QTY	STUD SIZE	
20719	25	4-6	
20720	25	8-10	
24746	100	BUTT	
20735	50	BUTT	
20730	25	1/4	
20729	25	1/4	
21836	10	3-WAY	
21837	5	4-WAY	













WIRE TERMINALS







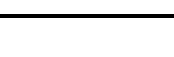



P.V.C. PLASTIC SOLDERLESS TERMINALS

P.V.C. Plastic Insulating Sleeve

16-14 Wire Range (Blue)

- Butted seam with funnel entry.

J&B #	QTY	STUD SIZE	
20695	50	4-6	
20696	50	4-6	
24730	100	8-10	
20697	50	8-10	
24731	100	12-1/4	
20698	25	12-1/4	
20705	25	3/8	
20626	25	4-6	
24740	100	8-10	
20627	25	8-10	
20716	25	4-6	
20717	25	8-10	
20721	25	4-6	

J&B #	QTY	STUD SIZE	
20722	25	8-10	
24747	100	BUTT	
20736	50	BUTT	
20733	25	3/16	
20734	25	3/16	
24756	100	1/4	
20727	25	1/4	
24757	100	1/4	
20728	25	1/4	
21838	10	3-WAY	
21839	5	4-WAY	























WIRE TERMINALS

P.V.C. PLASTIC SOLDERLESS TERMINALS

P.V.C. Plastic Insulating Sleeve

12-10 **Wire Range (Yellow)**

- Butted seam with funnel entry.



J&B #	QTY	STUD SIZE		J&B #	QTY	STUD SIZE	
20706	25	4-6		20718	25	8-10	
24732	100	8-10		20723	25	8-10	
20699	25	8-10		24748	100	BUTT	
24733	100	12-1/4		20737	25	BUTT	
20700	25	12-1/4		20731	25	1/4	
24734	100	1/4-5/16		20732	25	1/4	
20701	25	1/4-5/16		21840	5	3-WAY	
24735	100	5/16-3/8		21842	5	4-WAY	
20702	20	5/16-3/8					
24736	50	7/16-1/2					
20703	15	7/16-1/2					
20628	25	4-6					
24741	100	8-10					
20629	25	8-10					

WIRE TERMINALS

P.V.C. PLASTIC SOLDERLESS TERMINALS

P.V.C. Plastic Insulating Sleeve

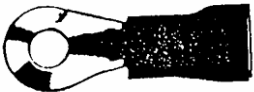
8 Gauge Wire Range (Red)

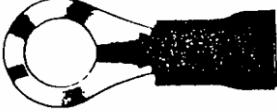
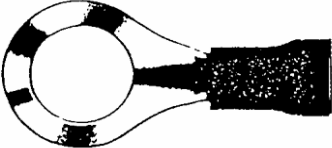
J&B #	QTY	STUD SIZE	
22004	25	BUTT	
41210	25	8-10	
41212	25	12-1/4	
22000	20	5/16-3/8	
22002	15	7/16-1/2	

WIRE TERMINALS

P.V.C. PLASTIC SOLDERLESS TERMINALS

P.V.C. Plastic Insulating Sleeve

6 Gauge Wire Range (Blue)

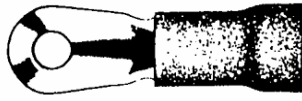
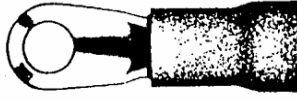
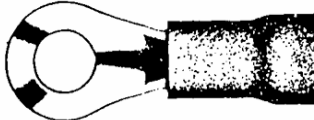
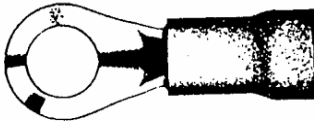
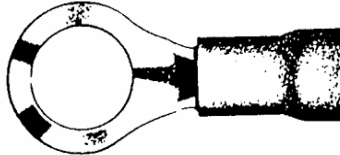

J&B #	QTY	STUD SIZE	
41214	15	BUTT	
41218	25	8-10	
41219	25	12-1/4	
41220	25	1/4-5/16	
41221	20	5/16-3/8	
41223	15	7/16-1/2	

WIRE TERMINALS

P.V.C. PLASTIC SOLDERLESS TERMINALS

P.V.C. Plastic Insulating Sleeve

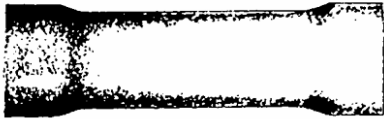
4 Gauge Wire Range (Yellow)

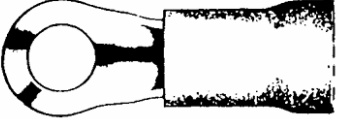
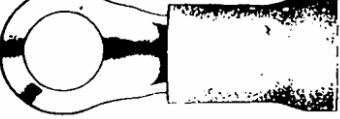





J&B #	QTY	STUD SIZE	
41226	10	BUTT	
41230	10	12-1/4	
41231	10	1/4-5/16	
41232	10	5/16-3/8	



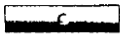





WIRE TERMINALS

NON-INSULATED SOLDERLESS TERMINALS

Silver Brazed Barrel

- The brazing allows the terminal to be crimped in any position around the barrel and this also helps give extra wire holding strength.

22-18 WIRE RANGE			
J&B #	QTY	STUD SIZE	
39475	100	BUTT	
39490	50	6	
39491	50	10	
39492	50	10	
55914	50	1/4	
55915	50	1/4	





16-14 WIRE RANGE			
J&B #	QTY	STUD SIZE	
39476	100	BUTT	
39493	50	6	
39494	50	10	
39495	50	1/4	
39489	50	1/4 90° flag	
39497	50	10	
20744	25	8-10 flag	
55903	50	1/4	
55908	50	1/4	



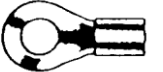
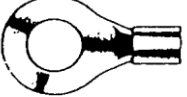
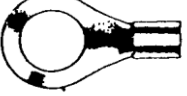
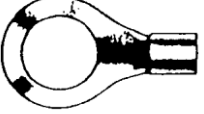

WIRE TERMINALS

NON-INSULATED SOLDERLESS TERMINALS

Silver Brazed Barrel

- The brazing allows the terminal to be crimped in any position around the barrel and this also helps give extra wire holding strength.

12-10 WIRE RANGE			
J&B #	QTY	STUD SIZE	
39477	100	BUTT	
39498	50	10	
39499	50	1/4	
39500	50	5/16	
39501	50	3/8	
39502	50	10	
55901	50	1/4	
55909	50	1/4	

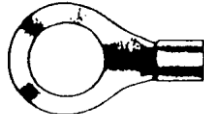
8 GA. WIRE RANGE			
J&B #	QTY	STUD SIZE	
55897	25	BUTT	
55898	25	10	
55899	25	1/4	
55868	20	3/8	
55869	15	1/2	

WIRE TERMINALS

IN-LINE BUTT CONNECTORS

Join two wires to one

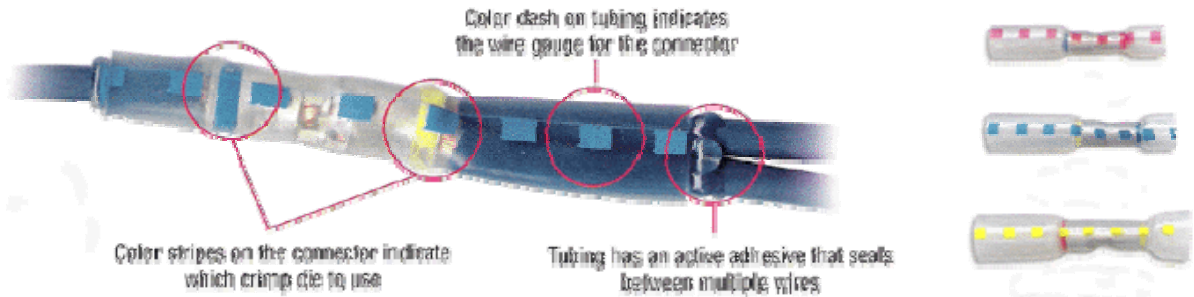

J&B #	WIRE GAUGE	TUBING COLOR	COLOR STRIPE ON CONNECTOR	WIRE	CRIMP DIE (Insulated)	QTY
41902	20-18 AWG	Clear / Red dashes	Side 1 : Red Side 2 : Blue	(1) 20-18 AWG (2) 20-18 AWG	Red (20-18 AWG) Blue (16-14 AWG)	25
41903	16-14 AWG	Clear / Blue dashes	Side 1 : Blue Side 2 : Yellow	(1) 16-14 AWG (2) 16-14 AWG	Blue (16-14 AWG) Yellow (12-10 AWG)	25
41904	12-10 AWG	Clear / Yellow dashes	Side 1 : Yellow Side 2 : Red	(1) 12-10 AWG (2) 12-10 AWG	Yellow (12-10 AWG) Red (8 AWG)	25

CLOSED-END CONNECTORS

Closed-end connectors are crimped here. In environments where corrosion and/or vibration are a problem, the closed-end connector can be used to replace wire nuts and other similar connectors.

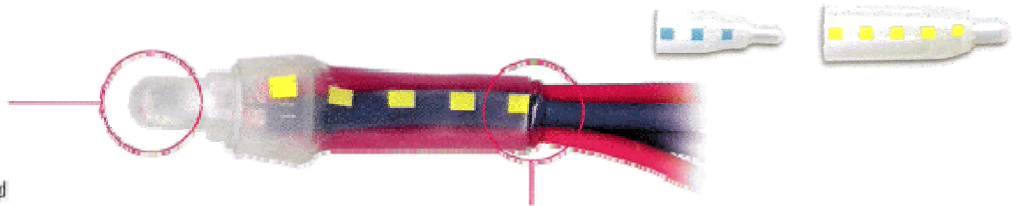

Tubing has an active adhesive that seals multiple wires and eliminates wire pull-out



Join two to four wires

J&B #	CONNECTOR WIRE RANGE	TUBING COLOR	QTY
41906	22-14 AWG	Clear / Blue dashes	25
41907	18-10 AWG	Clear / Yellow dashes	25

WIRE TERMINALS









KRIMP-N-SEAL CONNECTORS

- **EASY TO SEE:** The clear heat shrink tubing allows the user to see that the stripped wire is properly inserted into the color coded nylon insulated connector. It also ensures that the connector is crimped in the proper place without guess work.
- **STRONG SEAL:** The self sealing tubing encapsulates the connection as sealant inside tubing melts when heat is applied. Seals out corrosion causing moisture and air plus provides strain relief and vibration resistance.
- **SINGLE UNIT CONNECTION:** One complete unit has advantages over other methods. The user no longer has to deal with two separate pieces. This enables a faster installation and ensures heat shrink tubing is applied. The tubing remains permanent and cannot unravel as is the tendency with electrical tape.

WHITE 24-22 GAUGE			
J&B #		STUD	QTY
39436		# 4	25
39437		# 8	25
39443		BUTT	25

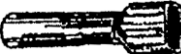

STEP DOWN BUTT CONNECTORS		
J&B #	GAUGE	QTY
39453	24-22 to 20-18	25

RED 20-18 GAUGE			
J&B #		STUD	QTY
39458		8 - 10	25
42130		1/4	25
39470		BUTT	25
46700			100
42126		F-CONN 1/4 TAB	25
42128		M-CONN 1/4 TAB	25
39412		FORK 8-10	25
39409		F-CONN 1/4 TAB	25
39410		M-CONN 1/4 TAB	25

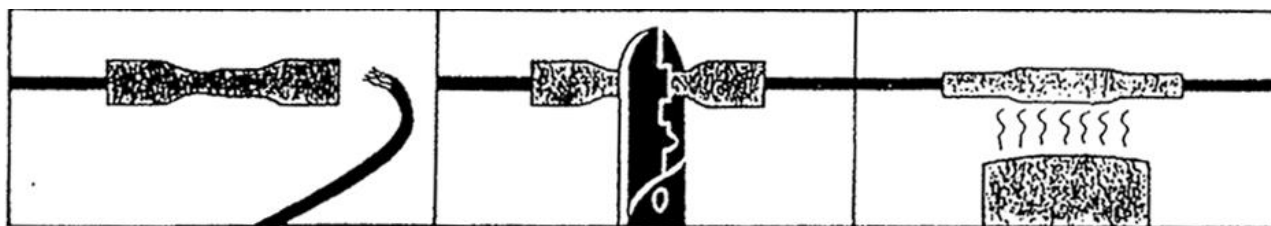

Insert stripped end of wire into butt splice.





Crimp splice in nest of tool designed for insulated connectors.

Apply heat source of approximately 275°F to 650°F. Move heat back and forth across tubing until shrinkage occurs. Allow to cool.

WIRE TERMINALS









KRIMP-N-SEAL CONNECTORS

- **EASY TO SEE:** The clear heat shrink tubing allows the user to see that the stripped wire is properly inserted into the color coded nylon insulated connector. It also ensures that the connector is crimped in the proper place without guess work.
- **STRONG SEAL:** The self sealing tubing encapsulates the connection as sealant inside tubing melts when heat is applied. Seals out corrosion causing moisture and air plus provides strain relief and vibration resistance.
- **SINGLE UNIT CONNECTION:** One complete unit has advantages over other methods. The user no longer has to deal with two separate pieces. This enables a faster installation and ensures heat shrink tubing is applied. The tubing remains permanent and cannot unravel as is the tendency with electrical tape.

BLUE 16-14 GAUGE			
J&B #		STUD	QTY
39408		F-CONN 1/4 TAB	25
39407		M-CONN 1/4 TAB	25
42136		F-BULLET	25
42134		M-BULLET	25

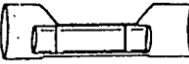

STEP DOWN BUTT CONNECTORS		
J&B #	GAUGE	QTY
42123	22-18 to 16-14	25
42124	16-14 to 12-10	25

BLUE 16-14 GAUGE			
J&B #		STUD	QTY
39415		# 8	25
39462		#10	25
39463		1/4	25
39464		5/16	25
39465		3/8	25
39472		BUTT	25
46702			100
39454		F-CONN 1/4 TAB	25
39455		M-CONN 1/4 TAB	25
39460		FORK 8-10	25

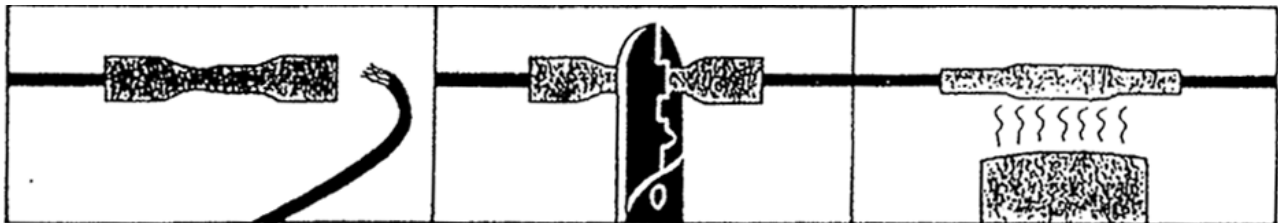

Insert stripped end of wire into butt splice.











Crimp splice in nest of tool designed for insulated connectors.



Apply heat source of approximately 275°F to 650°F. Move heat back and forth across tubing until shrinkage occurs. Allow to cool.

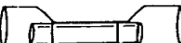



WIRE TERMINALS

KRIMP-N-SEAL CONNECTORS

- **EASY TO SEE:** The clear heat shrink tubing allows the user to see that the stripped wire is properly inserted into the color coded nylon insulated connector. It also ensures that the connector is crimped in the proper place without guess work.
- **STRONG SEAL:** The self sealing tubing encapsulates the connection as sealant inside tubing melts when heat is applied. Seals out corrosion causing moisture and air plus provides strain relief and vibration resistance.
- **SINGLE UNIT CONNECTION:** One complete unit has advantages over other methods. The user no longer has to deal with two separate pieces. This enables a faster installation and ensures heat shrink tubing is applied. The tubing remains permanent and cannot unravel as is the tendency with electrical tape.

YELLOW 12-10 GAUGE			
J&B #		STUD	QTY
39413		#8	25
39466		#10	25
39467		1/4	25
39414		5/16	25
39468		3/8	25
42132		1/2	25
39474		BUTT	25
46704			100
39456		F-CONN 1/4 TAB	25
39457		M-CONN 1/4 TAB	25

YELLOW 12-10 GAUGE			
J&B #		STUD	QTY
39411		FORK 8-10	25
39406		F-CONN 1/4 TAB	25
39405		M-CONN 1/4 TAB	25

RED #8 GAUGE			
J&B #		STUD	QTY
39439		1/4	25
39440		3/8	25
39441		1/2	25
39438		BUTT	25

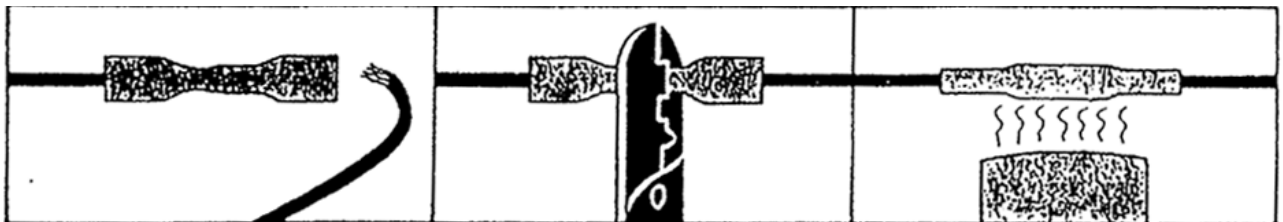

Insert stripped end of wire into butt splice.

Crimp splice in nest of tool designed for insulated connectors.

Apply heat source of approximately 275°F to 650°F. Move heat back and forth across tubing until shrinkage occurs. Allow to cool.

WIRE TERMINALS

OPTISEAL CONNECTORS Sealed Window Crimp Connectors

- Ensures the wire is crimped to connector.
- Ensures the center of crimp barrel is properly crimped.
- Crystal Clear waterproof insulation allows for indisputable inspection of the wire's condition.



J&B #	WIRE	COLOR	QTY
45692	22-18	RED	25
45693	16-14	BLUE	25
45694	12-10	YELLOW	25

Color-Coded Window Butt Connectors:



- Window in center of connector ensures that wire is seated properly and that the wire is being crimped to connector.
- Color-coded stripes identify wire gauge size to be used with connector.
- Color-coded stripes also indicate/guide the installer to the proper crimp position on the center of the barrel.
- Seamless barrel butt connectors ensure superior crimp performance.
- Wire-stop in butt connectors prevents over-insertion of wire.

Crystal Clear Adhesive-Lined Heat Shrink Tubing:



- Crystal Clear tubing provides optimal clarity for visual inspection.
- Adhesive-lined tubing ensures a waterproof seal.
- Wire gauge imprint simplifies wire size identification.

WIRE TERMINALS

ELEKTRALINK™ Sealed Solder Connector

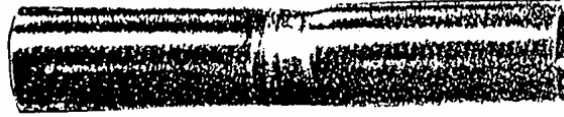

ELEKTRALINK PREVENTS . . .

- **CORROSION** - and corrosion build-up at the connection can cause a drop in current or complete disconnection of the circuit. Electrical tape, the most common means of preventing corrosion, does not provide a moisture proof seal but Elektralink takes care of this problem all in one step.
- **VIBRATION** - can cause connectors weakened by corrosion or inadequate strain relief to break off. Elektralink offers strain relief protection far superior to current products.
- **MIS-CONNECTED PARTS** - result from poorly installed connectors. A common problem is faulty connection at installation caused by lack of or excess crimping force. Elektralink eliminates crimping forever!

ELEKTRALINK FEATURES . . .

- **AN ADHESIVE LINED SLEEVE** - when the connector is heated to shrink the tubing, the adhesive flows and seals the connection. This gives a superior environmental and moisture proof seal that prevents corrosion.
- **HEAT SHRINKABLE CONSTRUCTION** - the combination of a solder connection and heat shrinkable tubing gives this product excellent long-term vibration resistance and strain relief.

Pull-out strength comparison:

Standard nylon butt splice - 40 lbs.
Heat shrinkable tubing w/o adhesive - 65 lbs.
Heat shrinkable tubing w/adhesive - 110 lbs.
Elektralink - 150 lbs.

- **EASY SOLDER LINK** - solder provides the finest link between two wires yet it has always been very time consuming and frustrating to perform this process. Elektralink does all of this in one easy step to save installation time while providing the perfect connection.

J&B #	GAUGE	TUBING COLOR	QTY
40400	22-18	RED	25
40401	16-14	BLUE	25
40402	12-10	YELLOW	25

WIRE TERMINALS

MULTILINK™

Sealed Krimp and Solder Connector



MULTILINK PREVENTS . . .

- **CORROSION** - and corrosion build-up at the connection can cause a drop in current or complete disconnection of the circuit. Electrical tape, the most common means of preventing corrosion, does not provide a moisture proof seal but Multilink takes care of this problem all in one step.
- **VIBRATION** - can cause connectors weakened by corrosion or inadequate strain relief to break off. Elektralink offers strain relief protection far superior to current products.
- **MIS-CONNECTED PARTS** - result from poorly installed connectors. A common problem is faulty connection at installation caused by lack of or excess crimping force.

MULTILINK FEATURES . . .

- **CRIMPED** for maximum reliability, **SOLDERED** for strength and conductivity, and **SEALED** for superior durability.
- **AN ADHESIVE LINED SLEEVE** - when the connector is heated to shrink the tubing, the adhesive flows and seals the connection. This gives a superior environmental and moisture proof seal that prevents corrosion.
- **HEAT SHRINKABLE CONSTRUCTION** - the combination of a solder connection and heat shrinkable tubing gives this product excellent long-term vibration resistance and strain relief.



J&B #	GAUGE	TUBING COLOR	QTY
45635	22-18	RED	25
45636	16-14	BLUE	25
45637	12-10	YELLOW	25

WIRE NUT CONNECTORS

HARD PLASTIC

- Screws on like a nut and holds firmly with a wiring crushing crimp. Will not fall off, shake off or pull off.
- 600 volts maximum building wiring; 1000 volts in fixtures and signs.



25126
Gray

25127
Blue

25128
Orange

25129
Yellow

25130
Red

J&B #	WIRE RING	MIN	MAX	QTY
25126	22 to 16	1 #20 w/1 #22	2 #16	25
25127	22 to 14	3 #22	3 #16	25
25128	22 to 14	3 #22	2 #14 w/1 #18	25
25129	18 to 10	1 #14 w/1 #18	1 #10 w/1 #14	25
25130	18 to 10	2 #14	4 #12	25

WING HARD PLASTIC

- Positive bottoming design eliminates ratcheting and loose, unsure connections.
- 600 V maximum for building wiring; 1000 V maximum in fixtures and signs; temperature rating of 105°C (221°F) maximum.

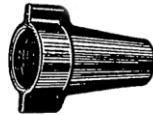

25145
Gray

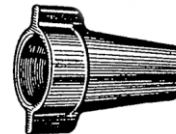

25146
Blue

J&B #	WIRE RING	MIN	MAX	QTY
25145	18-8	2 #12	3 #10 w/1 #12	25
25146	14-6	1 #10 w/1 #12	1 #6 w/2 #8	25

SOFT PLASTIC

- U.L. listed as a pressure-type fixture connector for up to 105°C (221°F) maximum.



22217
Red

J&B #	WIRE RING	MIN	MAX	QTY
22217	16 to 10	3 #16	3 #12	25



WIRE NUT CONNECTORS

3M COMBO WIRE NUT

- **Simplifies** selection of the right connector for a wide range of wiring jobs.
- 600 volts maximum building wiring; 1000 volts in fixtures and signs; temperature rating of 105°C (221°F) maximum.
- Orange/blue replaces the orange, blue, and gray style wire nut connectors.
- Red/yellow replaces the red and yellow style wire nut connectors.



41177
Orange / Blue



41178
Red / Yellow



41179
Blue / Grey

J&B #	WIRE RING	MIN	MAX	QTY
41177	22 to 12	2 #22	2 #12	25
41178	18 to 8	2 #18	2 #8	25
41179	14 to 6	4 # 14	2 # 6	25

SAFETY SEALED WATERPROOF WIRE NUT

- Suitable for all wire splices, especially those exposed to condensation, water, vapors or dust.
- One step installation.
- Corrosion proof; reduces risk of fire.
- For use in irrigation, trailers, boats or any standard application.



J&B #	WIRE RING	MIN	MAX	QTY
41176	22 to 8	6 # 22	4 # 12	20

WIRING DEVICES

QUICK SPLICE

- Two piece quick splice makes insulated tap-in, parallel or pig-tail in seconds without cutting, stripping, taping or soldering.
- Resilient “spring” action provides firm, positive grip against vibration.
- Insert wires into case and press metal grip down with pliers, then close case cover.

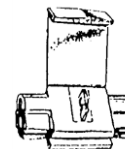

J&B #	GAUGE	COLOR	QTY	APPLICATION
20787	22-18	RED	50	LOW VOLTAGE
20788	18-14	BLUE	50	LOW VOLTAGE
20790	12-10	YELLOW	50	LOW VOLTAGE

DISCONNECTING T-TAP

- No stripping is required - place wire to be tapped in locating notch and close with common pliers.
- Automotive, accessory, fleet and shop applications.
- Tap is FULLY INSULATED and ready to accept J&B #22290 (16-14 wire size).

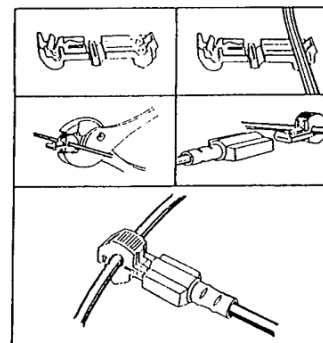

J&B #	GAUGE	QTY
20786	18-14	10

3 - WAY CONNECTOR W/ SEALANT

- Self-stripping connectors for making 2 or 3 wire pigtail connections with a wire range of 22-14 gauge.
- No wire stripping is required, simply insert wires and press top down with pliers.
- The sealant helps to protect against corrosion due to moisture. Use where a positive connection is required.

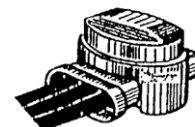
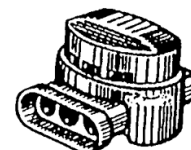

J&B #	GAUGE	QTY
20792	22-14	10

FEMALE FLAG QUICK CONNECTS

- Fully insulated 90° flag 1/4” push on.



J&B #	GAUGE	COLOR	QTY
22285	22-18	RED	25
22286	16-14	BLUE	25

WIRE TERMINALS

SNAP PLUGS (Bullet Connectors)

P.V.C. PLASTIC INSULATED SLEEVE



J&B #	SIZE	RANGE	QTY
20741	.156"	16-14	25
24755	.156"	16-14	100
20743	.180"	16-14	25

NYLON INSULATED SLEEVE



J&B #	SIZE	RANGE	QTY
22066	.156"	16-14	25

RECEPTACLES

- Converts wire to snap plug receptacle for quick connection/disconnection.

NYLON SNAP PLUG RECEPTACLES



J&B #	STYLE	RANGE	QTY
20004	.156"	22-18	25
20003	.156"	16-14	25
20006	.180"	16-14	25

INSULATED SNAP PLUG RECEPTACLE 2-WAY



J&B #	STYLE	QTY
20766	STANDARD	25

- For use with J&B #20741, 24755 & #22066

PIN TERMINALS

Nylon Insulated Sleeve

J&B #	RANGE	COLOR	QTY	
20763	22-18	RED	50	
20764	16-14	BLUE	50	
20762	12-10	YELLOW	50	

WIRE TERMINALS

QUICK CONNECTORS

- Used for parking lights, tail lights and other wiring harness applications on GM cars.

MALE END

FEMALE END



20630

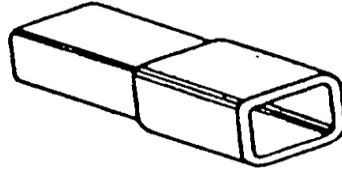

20759

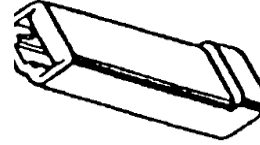

20746

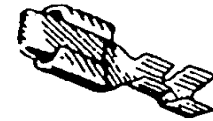

20745

J&B #	STYLE	GAUGE	QTY
20630	SPLIT TAB	16-14	25
20759	HOUSING	16-14	25
20745	SPLIT TAB	16-14	25
20746	HOUSING	16-14	25

* Terminals should be attached to wire before insertion into housing.

NYLON CLOSED END CONNECTORS

J&B #	GAUGE	QTY	
20749	16-14	25	
20750	12-10	25	

PIGGY BACK TERMINAL

- For power block 1/4" tab.
- Bent back tab is for extra connection.

J&B #	GAUGE	QTY	
20765 Non-insul.	16-14	25	
41234 (Plastic)	16-14	50	

.250 PUSH-ON TERMINAL ADAPTER

Two .250" Male to one .250" Female

J&B #	QTY
41233	50

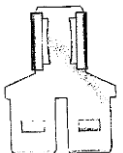

WIRE TERMINALS

DELPHI PACKARD WEATHER-PACK TERMINALS

- Locking connectors are sealed against moisture, dust and dirt.
- Available in one through six contact configurations.
- These nylon connectors are rated from -40 F to +257 F.
- The terminals and seals are secured in the connector body with a hinge lock assembly.
- Silicone seals must be used with the tin plated brass terminals.
- Use the cavity plug for all pin locations not filled with terminals. Rated to 16 volts D.C. and 20 amps maximum.
- The tower half connector body comes with a self lubricating silicone seal to reduce the engagement assembly force.

CABLE SEAL



J&B #	CABLE DIA. MM	GPT WIRE GAUGE	SXL WIRE GAUGE	SEAL COLOR	PACKARD #	QTY
42300	1.70-1.29	-	-	RED	12015899	25
42301	2.80-2.03	18-16	20-18	GREEN	12015323	25
42302	3.49-2.81	14	16	GRAY	12010293	25
42303	4.30-3.45	12	14	BLUE	12015193	25

Ordering Notes

1. Select connector body style from chart.
2. One terminal for each contact location needed.
3. Pick cable seal by wire gauge.
4. Cavity plugs are required for all unused pin locations.
5. Weather-Pack crimping tool must be used to assure a good seal.

CONNECTOR BODIES

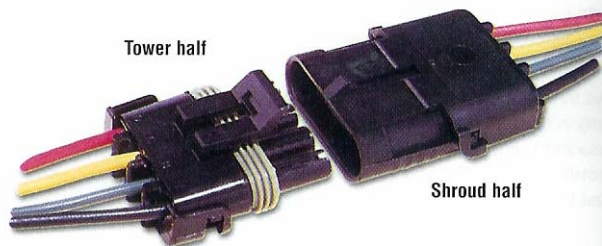

Typical four contact configuration

CONTACTS	J&B# TOWER HALF	PACKARD #	J&B# SHROUD HALF	PACKARD #	QTY
1	42306	12015791	42315	12010996	5
2	42307	12015792	42316	12010973	5
3	42308	12015793	42317	12010717	5
4	42309	12015797	42318	12010974	5
6	42311	12015799	42320	12010975	2

WIRE TERMINALS

DELPHI PACKARD WEATHER-PACK TERMINALS

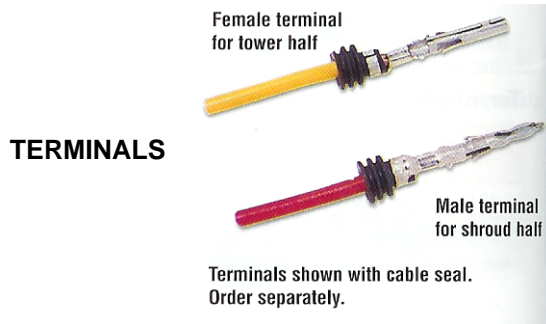

WIRE GAUGE	J&B# MALE TERMINAL	PACKARD #	J&B# FEMALE TERMINAL	PACKARD #	QTY
20-18	42330	12089040	42333	12089188	25
16-14	42331	12124582	42334	12124580	25
12-10	42332	12124587	42335	12124581	25

CAVITY PLUG



J&B #	PACKARD #	QTY
42340	12010300	25

REMOVAL TOOL



J&B #	PACKARD #	QTY
42341	12014012	EA

DEUTSCH DT SERIES

DEUTSCH DT SERIES RECEPTACLES

- The Deutsch DT Series sealed RECEPTACLE HOUSINGS make up half of the complete DT Series system connection.
- The Deutsch DT Series RECEPTACLE WEDGES are made from a thermoplastic material for a durable and lasting hold.
- The receptacles are designed with thermoplastic housings & silicone rear wire interface seals, which make them extremely durable & able to withstand exposure to moisture & a wide temperature range.
- They have an IP68 immersion rating & show no defects after 100 cycles of engagement & disengagement.
- Operating temperature -55 degree C to .125 degree C (-67 degree F to 257 degree F).
- Accepts size 16 contacts (14-20 ga., 13 amps). Integrated latch for mating.



57125 Pin Contact
57127 Pin Contact



57124 Sealing Plug used to plug any open or unused pin or socket contacts.

To complete a receptacle assembly, you will need:
1 receptacle housing.
1 receptacle wedge.
2,3,4,6,8 or 12 receptacle pin contacts.

J&B #	HOUSING	J&B #	WEDGE	QTY
57100	2-WAY	57101	2-WAY	EA
57104	3-WAY	57105	3-WAY	EA
57108	4-WAY	57109	4-WAY	EA
57112	6-WAY	57113	6-WAY	EA
57116	8-WAY	57117	8-WAY	EA
57120	12-WAY	57121	12-WAY	EA

J&B #	DESCRIPTION	QTY
57125	20-16 Ga. Pin	50
57127	14 Ga. Pin	50
57124	Sealing Plug	50

** Pins are nickel plated solid barrel

DEUTSCH DT SERIES

DEUTSCH DT SERIES PLUGS

- The Deutsch DT Series sealed PLUG HOUSINGS make up half of the complete DT Series system connection.
- The Deutsch DT Series PLUG WEDGES are made from a thermoplastic material for a durable and lasting hold.
- The plugs are designed with thermoplastic housings & silicone rear wire interface seals, which make them extremely durable & able to withstand exposure to moisture & a wide temperature range.
- They have an IP68 immersion rating & show no defects after 100 cycles of engagement & disengagement.
- Operating temperature -55 degree C to .125 degree C (-67 degree F to 257 degree F).
- Accepts size 16 contacts (14-20 ga., 13 amps). Integrated latch for mating.



To complete a plug assembly, you will need:
1 plug housing.
1 plug wedge.
2,3,4,6,8 or 12 plug socket contacts.

57126 Socket Contact
57128 Socket Contact

57124 Sealing Plug used to plug any open or unused pin or socket contacts.

J&B #	HOUSING	J&B #	WEDGE	QTY
57102	2-WAY	57103	2-WAY	EA
57106	3-WAY	57107	3-WAY	EA
57110	4-WAY	57111	4-WAY	EA
57114	6-WAY	57115	6-WAY	EA
57118	8-WAY	57119	8-WAY	EA
57122	12-WAY	57123	12-WAY	EA

J&B #	DESCRIPTION	QTY
57126	20-16 Ga. Pin	50
57128	14 Ga. Pin	50
57124	Sealing Plug	50

** Sockets are nickel plated solid barrel

DEUTSCH SERIES

DEUTSCH SERIES REMOVAL TOOL

- The Deutsch multi-use removal tool has a small hook on one end for wedgelock removal and a small screwdriver on the other end for contact removal, pushing back the locking fingers to release the contact.
- It is for use with the Deutsch DT, DTM and DTP series.



J&B #	QTY
57129	EA

DEUTSCH SERIES REMOVAL TOOL

Size 16 Contacts

- Deutsch contact removal tools are specific to contact size and are used for contact removal in connectors that utilize a round shoulder contact retention system.
- They are required for wire removal in the DTHD and Jiffy splice series.
- Compact and easy to use. Heavy duty plastic construction.
- Removes contacts without damaging wire, insulation, connector seals, or connector bodies.
- Use with Deutsch Jiffy splice.



J&B #	QTY
57130	EA

DEUTSCH SERIES JIFFY SPLICE

Size 16

- Deutsch jiffy splices are a unique, field-servicable alternative to permanent splices.
- Inside the body of the jiffy splice is a contact retention system that secures a mated pair of Deutsch contacts in a compact, environmentally sealed unit.
- Made from the same high quality silicone elastomer as Deutsch connector seals.
- Accepts one size 16 pin and one size 16 socket.
- Simple to install and service.



J&B #	QTY
57131	EA

HEAT SHRINK TUBING

MULTIPLE THICK WALL TUBING

With Meltable Sealant

- Soft heat shrinkable polyolefin tubing, cross-linked to provide a meltable inner wall.
- Outer tubing shrinks and conforms to the geometry to be covered while the inner wall melts and flows to provide environmental protection.
- Long term strain relief and greater flexibility which offers less strain at wire/insulation interface; dielectric insulation.
- Operates continuously between -50°F and 275°F.

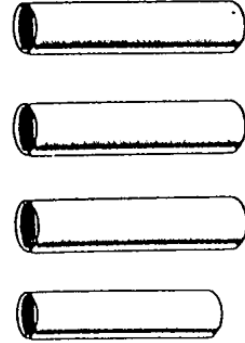

J&B #	WIRE RANGE	PRE-SHRINK ID	POST SHRINK ID	COLOR	LENGTH	QTY
*57030		1/16	.031	BLACK	6"	10
*57031		3/32	.046	BLACK	6"	10
38750	30-18 GA	1/8"	3/64"	BLACK	6"	4
57050	30-18 GA	1/8"	3/64"	RED	6"	4
38751	20-14 GA	3/16"	1/16"	BLACK	6"	4
57051	20-14 GA	3/16"	1/16"	RED	6"	4
38752	18-10 GA	1/4"	3/32"	BLACK	6"	4
57052	18-10 GA	1/4"	3/32"	RED	6"	4
38754	12-16 GA	3/8"	1/8"	BLACK	6"	4
57053	12-16 GA	3/8"	1/8"	RED	6"	4
V38753	2-4/0 GA	1"	5/16"	BLACK	12"	4

* Part #'s 57030 & 57031 do not have sealant.

HEAT SHRINK TUBING

MULTIPLE EXTRA THICK WALL TUBING

With Meltable Sealant

- Semi-rigid heat shrinkable polyolefin tubing, cross-linked to provide a meltable inner wall.
- Outer tubing shrinks and conforms to the geometry to be covered while the inner wall melts and flows to provide environmental protection.
- Thicker wall provides greater dielectric strength for insulating battery cables and connectors.
- Operates continuously from -85°F to +275°F.

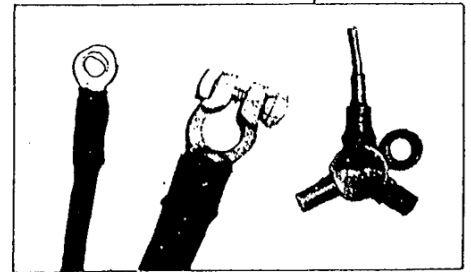

J&B #	WIRE RANGE	PRE SHRINK ID	POST SHRINK ID	COLOR	LENGTH	QTY
21162	18-14 GA	3/8"	.100"	BLACK	6"	4
38660	14-6 GA	1/2"	.150"	BLACK	6"	4
57054	14-6 GA	1/2"	.150"	RED	6"	4
38662	8-1 GA	3/4"	.200"	BLACK	6"	4
40362	8-1 GA	3/4"	.200"	RED	6"	4
38664	2-4/O GA	1"	.370"	BLACK	6"	4
40364	2-4/O GA	1"	.370"	RED	6"	4
60020		1-1/2"	.500"	BLACK	6"	2
60021		2"	.650"	BLACK	6"	2

MULTIPLE WALL TUBING

"Color Coded"

- Radiation cross-linked, heat shrinkable tubing with meltable adhesive liner.
- Superior environmental resistance to mechanical abuse, water, salt, abrasion and other corrosive materials.
- Excellent vibration resistance and strain relief.
- Rated for continuous operation at temperatures from -55°C (-67°F) to 110°C (+230°F).

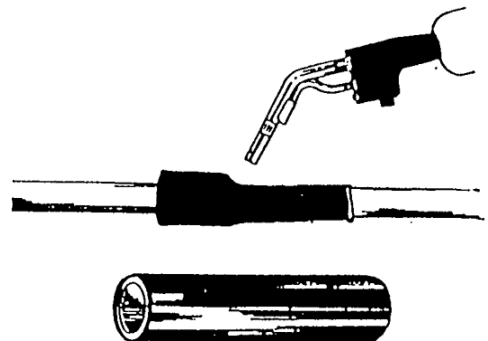

J&B #	WIRE RANGE	PRE SHRINK ID	COLOR	LENGTH	QTY
40979	24-22	1/8"	WHITE	6"	4
40980	22-18	3/16"	RED	6"	4
40981	16-14	1/4"	BLUE	6"	4
40982	12-10	5/16"	YELLOW	6"	4

CABLE TIES

- Cable ties feature smooth edges and low insertion force.
- Locking system assures a firm grip.
- Once cable ties are installed, harness assembly won't slip, even after flexing and bending.
- Ties are manufactured from 6.6 nylon and are QPL and UL listed.



J&B #	WIDTH & LENGTH	TENSILE	QTY
38952	3/32 x 4"	18 lb.	100
38955	1/8 x 5"	40 lb.	100
38956	3/16 x 7"	50 lb.	100
38953	3/16 x 11"	50 lb.	100
38957	3/16 x 14"	50 lb.	100
38958	5/16 x 14"	120 lb.	50

BLACK ULTRA VIOLET RESISTANT WIRE TIES

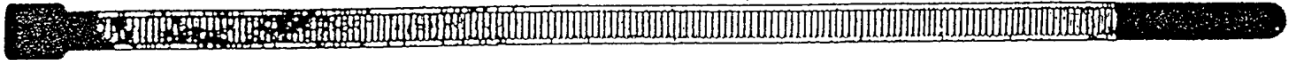

J&B #	WIDTH & LENGTH	TENSILE	QTY
38950	3/32 x 4"	18 lb.	100
38945	1/8 x 5"	40 lb.	100
38959	3/16 x 7"	50 lb.	100
38947	3/16 x 11"	50 lb.	100
38951	3/16 x 14"	50 lb.	100
38949	5/16 x 8."	120 lb.	100
38954	5/16 x 14"	120 lb.	50
21048	3/8 x 24"	175 lb.	50

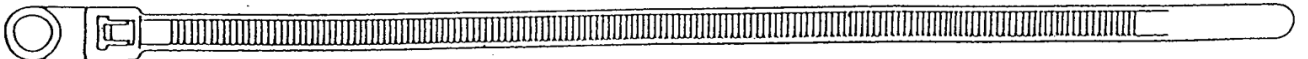

J&B #	HOLE	WIDTH & LENGTH	COLOR	TENSILE	QTY
12078	3/16	3/16 x 7"	BLACK	50 lb.	100
12079	3/16	3/16 x 14"	WHITE	50 lb.	25
12080	1/4	5/16 x 14"	WHITE	120 lb.	25
39005	1/4	5/16 x 15"	BLACK	120 lb.	100

CABLE TIES

RELEASABLE BLACK CABLE TIES

- Releasable Ties are reusable one piece design, weather resistant black nylon.
- Use for prototype work where wires will be added, or when a tie is needed for a temporary application.



Black Nylon UV Weather Resistant

J&B #	WIDTH & LENGTH	BUNDLE DIA	QTY
38946	7/32 x 5-7/8	3/16 x 1-1/4	100
38948	7/32 x 8-5/8	3/16 x 2-1/2	100

EXTRA LONG HEAVY DUTY

Black



J&B #	WIDTH & LENGTH	TENSILE	QTY
41186	3/8 x 48	175 lb.	50

CABLE STRAP

- Black nylon. Fits into 6.3mm (1/4") hole. Import cars.

J&B #	WIDTH & LENGTH	MAX BUNDLE	QTY
41870	5mm (3/16) x 200mm (8")	44mm (1-3/4")	25



NYLON TIE MOUNTS

J&B #	TYPE	QTY
40025	#6 Screw-On	25
40026	White Adhesive Backing	25
40027	Black Adhesive Backing	25



CABLE TIES

COLORED CABLE TIES

- Cable ties feature smooth edges and low insertion force.
- Locking system assures a firm grip.
- Once cable ties are installed, harness assembly won't slip, even after flexing and bending.
- Ties are manufactured from 6.6 nylon and are QPL and UL listed.



J&B #	COLOR	WIDTH & LENGTH	TENSILE	QTY
86120	BROWN	3/32 x 4	18 lb.	100
86121	RED	3/32 x 4	18 lb.	100
86122	ORANGE	3/32 x 4	18 lb.	100
86123	YELLOW	3/32 x 4	18 lb.	100
86124	GREEN	3/32 x 4	18 lb.	100
86125	BLUE	3/32 x 4	18 lb.	100
86126	PURPLE	3/32 x 4	18 lb.	100
86127	NEON PINK	3/32 x 4	18 lb.	100
*86128	MULTIPACK	3/32 x 4	18 lb.	100
41913	BROWN	3/16 x 7-1/2	50 lb.	100
41914	RED	3/16 x 7-1/2	50 lb.	100
41915	ORANGE	3/16 x 7-1/2	50 lb.	100
41916	YELLOW	3/16 x 7-1/2	50 lb.	100
41917	GREEN	3/16 x 7-1/2	50 lb.	100
41918	BLUE	3/16 x 7-1/2	50 lb.	100
41919	PURPLE	3/16 x 7-1/2	50 lb.	100
41921	NEON PINK	3/16 x 7-1/2	50 lb.	100
*41922	MULTIPACK	3/16 x 7-1/2	50 lb.	100

*10 Each of white, black, brown, red, orange, yellow, green, blue, purple & neon pink ties.

CABLE TIES

DUAL CLAMP TIES

- High impact heat stabilized nylon material.
- Ensures parallel spacing between cables & hoses; keeps them from rubbing against each other & deteriorating.
- Used in many cars, trucks & trailers where high tensile strength & flexibility is needed.
- Releasable straps. UV resistant. UL listed. RoHs compliant.
- Operating temperature range: -40 deg F to +230 deg F.



J&B #	WIDTH & LENGTH	BUNDLE DIA. MAX. EA SIDE	TENSILE STRENGTH	STUD SIZE	QTY
4300	1/2 x 13"	1.3"	150 lbs.	1/4	10
4305	1/2 x 19"	2.3"	150 lbs.	1/4	10

WIRE TOOLS

CRIMPING & CUTTING TOOL

- Cuts and strips wire from 22 to 10 gauge.
- Crimps insulated and non-insulated terminals.
- Cuts screws from 4-40 up to 10-32.
- Assembled with plastic comfort grip handles.

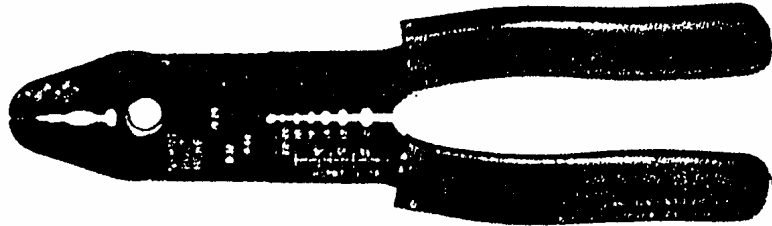

J&B #	QTY
20772	EA

SELF-ADJUSTING WIRE CUTTER/STRIPPER

- Unique steel jaws self-adjust to strip any wire 26-10 gauge.
- Crimps insulated and non-insulated 22 to 10 gauge and 7mm/8mm terminals.
- Precision machined blade for cutting wire sharp and smooth.

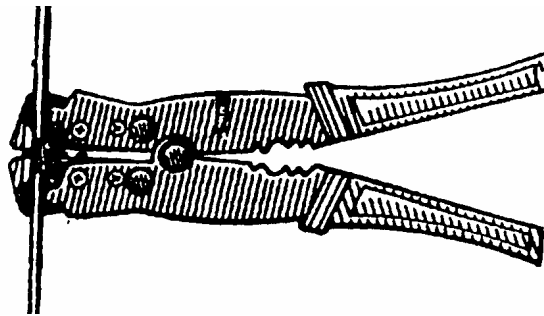

J&B #	QTY
39350	EA

WIRE TOOLS

RATCHET CRIMPING TOOL For Heat Shrink Terminals

- 4 crimp nests - 8, 10-12, 14-16, 18-22.
- Ensures uniform crimp termination regardless of user.
- Release switch if terminal or wire is inserted improperly.
- High quality, economical tool.
- Alignment guide to ensure dies won't slip during crimping.



J&B #	QTY
41209	EA

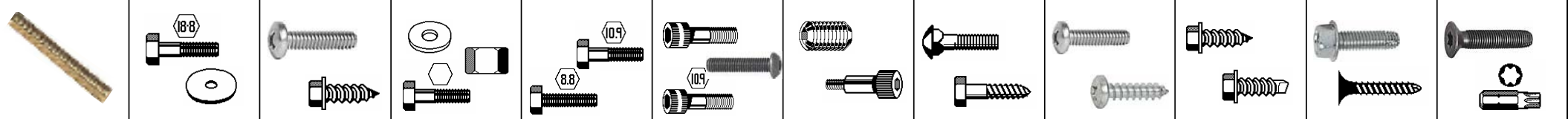















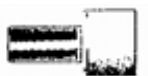





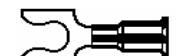

J&B Fleet - Industrial Supply

22428 Harrisburg-Westville Rd. Alliance, Ohio 44601 Phone: (330) 821-6342 Fax: (330) 821-0411

www.jbfleet.com

PART # 2011

NYLON TERMINALS

<p>21891 ¹ (41240)</p>  <p>8-10 RING 22-18</p> <p>20</p>	<p>21908 ²</p>  <p>6-8 RING 16-14</p> <p>20</p>	<p>21909 ³ (41250)</p>  <p>8-10 RING 16-14</p> <p>15</p>	<p>21910 ⁴ (41251)</p>  <p>12-1/4 RING 16-14</p> <p>10</p>	<p>21928 ⁵ (41274)</p>  <p>8-10 RING 12-10</p> <p>15</p>	<p>20749 ⁶</p>  <p>CRIMP SPLICE CONNECTOR 16-14</p> <p>10</p>
<p>21911 ⁷ (41252)</p>  <p>1/4-5/16 RING 16-14</p> <p>10</p>	<p>21912 ⁸</p>  <p>5/16-3/8 RING 16-14</p> <p>5</p>	<p>21929 ⁹ (41275)</p>  <p>12-1/4 RING 12-10</p> <p>10</p>	<p>21930 ¹⁰</p>  <p>1/4 - 5/16 RING 12-10</p> <p>10</p>	<p>21932 ¹¹</p>  <p>5/16-3/8 RING 12-10</p> <p>5</p>	<p>20750 ¹²</p>  <p>CRIMP SPLICE CONNECTOR 12-10</p> <p>10</p>
<p>21934 ¹³</p>  <p>7/16-1/2 RING 12-10</p> <p>5</p>	<p>21897 ¹⁴</p>  <p>8-10 FORK 22-18</p> <p>10</p>	<p>21915 ¹⁵ (41256)</p>  <p>8-10 FORK 16-14</p> <p>10</p>	<p>21903 ¹⁶ (41244)</p>  <p>BUTT CONNECTOR 22-18</p> <p>20</p>	<p>21921 ¹⁷ (41260)</p>  <p>BUTT CONNECTOR 16-14</p> <p>20</p>	<p>20788 ¹⁸</p>  <p>SCOTCHLOK CONNECTOR 18-14</p> <p>5</p>
<p>21942 ¹⁹ (41280)</p>  <p>BUTT CONNECTOR 12-10</p> <p>15</p>	<p>21952 ²⁰ (41264)</p>  <p>1/4 MALE 16-14</p> <p>10</p>	<p>21950 ²¹ (41265)</p>  <p>1/4 FEMALE 16-14</p> <p>10</p>	<p>22216 ²²</p>  <p>SPLICING CAP 24-12</p> <p>10</p>	<p>22066 ²³</p>  <p>SNAP PLUG 16-14</p> <p>10</p>	<p>20003 ²⁴</p>  <p>FEMALE PLUG 16-14</p> <p>10</p>

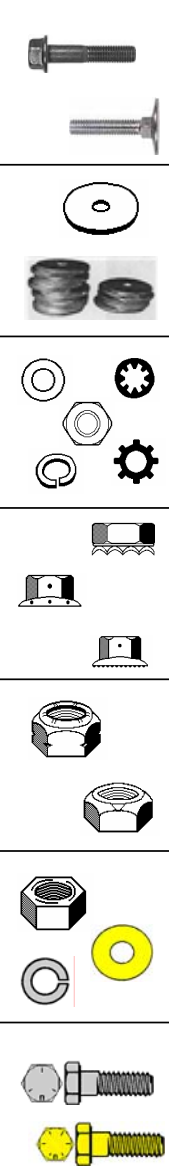

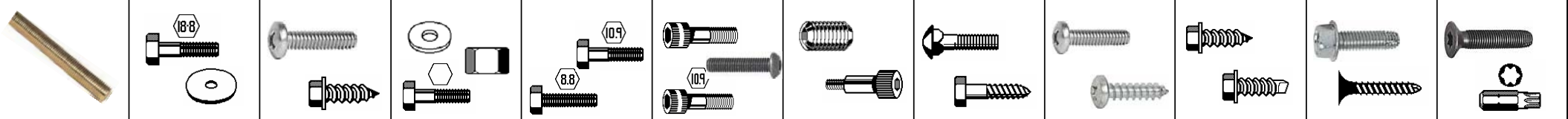



















J&B Fleet - Industrial Supply

22428 Harrisburg-Westville Rd. Alliance, Ohio 44601 Phone: (330) 821-6342 Fax: (330) 821-0411

www.jbfleet.com

PART # 2213

NYLON TERMINALS

<p>21942 ¹ (41280)</p>  <p>12-10 BUTT CONNECTOR</p> <p>10</p>	<p>21928 ² (41274)</p>  <p>8-10 RING 12-10</p> <p>10</p>	<p>21921 ³ (41260)</p>  <p>16-14 BUTT CONNECTOR</p> <p>10</p>	<p>21909 ⁴ (41250)</p>  <p>8-10 RING 16-14</p> <p>10</p>	<p>21903 ⁵ (41244)</p>  <p>22-18 BUTT CONNECTOR</p> <p>10</p>	<p>39184 ⁶</p>  <p>22-18 MALE DISCONNECT</p> <p>10</p>
<p>21934 ⁷</p>  <p>7/16-1/2 RING 12-10</p> <p>10</p>	<p>39185 ⁸ (41284)</p>  <p>FEMALE DISCONNECT 12-10</p> <p>10</p>	<p>21912 ⁹</p>  <p>5/16-3/8 RING 16-14</p> <p>10</p>	<p>22291 ¹⁰ (41268)</p>  <p>FEMALE DISCONNECT 16-14</p> <p>10</p>	<p>21888 ¹¹</p>  <p>4-6 RING 22-18</p> <p>10</p>	<p>21888 ¹²</p> <p>10</p>
<p>21932 ¹³</p>  <p>5/16-3/8 RING 12-10</p> <p>10</p>	<p>39186 ¹⁴ (41285)</p>  <p>MALE DISCONNECT 12-10</p> <p>10</p>	<p>21911 ¹⁵ (41252)</p>  <p>1/4-5/16 RING 16-14</p> <p>10</p>	<p>22290 ¹⁶ (41269)</p>  <p>MALE DISCONNECT 16-14</p> <p>10</p>	<p>21891 ¹⁷ (41240)</p>  <p>8-10 RING 22-18</p> <p>10</p>	<p>21891 ¹⁸</p> <p>10</p>
<p>21929 ¹⁹ (41275)</p>  <p>12-1/4 RING 12-10</p> <p>10</p>	<p>21929 ²⁰</p> <p>10</p>	<p>21910 ²¹ (41251)</p>  <p>12-1/4 RING 16-14</p> <p>10</p>	<p>21910 ²²</p> <p>10</p>	<p>39183 ²³</p>  <p>FEMALE DISCONNECT 22-18</p> <p>10</p>	<p>39183 ²⁴</p> <p>10</p>

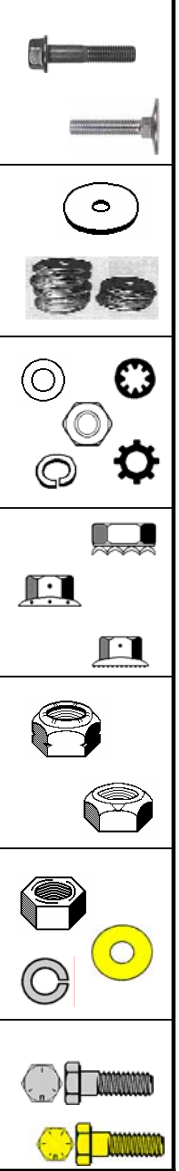



J&B Fleet - Industrial Supply









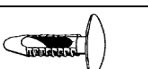





















22428 Harrisburg-Westville Rd. Alliance, Ohio 44601 Phone: (330) 821-6342 Fax: (330) 821-0411

www.jbfleet.com

PART # 2104

NYLON TERMINALS

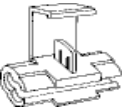

<p>22291 ¹ (41268)</p>  <p>FEMALE FULLY INSULATED 16-14</p> <p>5</p>	<p>22290 ² (41269)</p>  <p>MALE FULLY INSULATED 16-14</p> <p>5</p>	<p>21950 ³ (41265)</p>  <p>1/4 FEMALE 16-14</p> <p>5</p>	<p>21952 ⁴ (41264)</p>  <p>1/4 MALE 16-14</p> <p>5</p>	<p>20792 ⁵</p>  <p>3-WAY CONNECTOR W/SEALANT</p> <p>3</p>	<p>21901 ⁶</p>  <p>8 - 10 FORK 22-18</p> <p>5</p>	<p>21891 ⁷ (41240)</p>  <p>8 - 10 RING 22-18</p> <p>3</p>	<p>21903 ⁸ (41244)</p>  <p>BUTT CONNECT 10 22-18</p> <p>10</p>
<p>22066 ⁹</p>  <p>MALE SNAP PLUG 16-14</p> <p>3</p>	<p>21917 ¹⁰ (41258)</p>  <p>8 - 10 FORK 16 - 14</p> <p>3</p>	<p>21912 ¹¹</p>  <p>3/8 RING 16-14</p> <p>3</p>	<p>21911 ¹² (41252)</p>  <p>5/16 RING 16-14</p> <p>3</p>	<p>21910 ¹³ (41251)</p>  <p>1/4 RING 16-14</p> <p>5</p>	<p>21909 ¹⁴ (41250)</p>  <p>8 - 10 RING 16-14</p> <p>5</p>	<p>21907 ¹⁵</p>  <p>6-8 RING 16-14</p> <p>5</p>	<p>21921 ¹⁶ (41260)</p>  <p>BUTT CONNECT 16-14</p> <p>10</p>
<p>20003 ¹⁷</p>  <p>FEMALE RECEPTACLE 16-14</p> <p>3</p>	<p>21938 ¹⁸</p>  <p>8 - 10 FORK 12-10</p> <p>3</p>	<p>21934 ¹⁹</p>  <p>1/2 RING 12-10</p> <p>2</p>	<p>21932 ²⁰</p>  <p>3/8 RING 12-10</p> <p>3</p>	<p>21930 ²¹</p>  <p>5/16 RING 12-10</p> <p>3</p>	<p>21929 ²² (41275)</p>  <p>1/4 RING 12-10</p> <p>5</p>	<p>21928 ²³ (41274)</p>  <p>8 - 10 RING 12-10</p> <p>10</p>	<p>21942 ²⁴ (41280)</p>  <p>BUTT CONNECT 12-10</p> <p>10</p>
<p>39185 ²⁵ (41284)</p>  <p>FEMALE FULLY INSULATED 12-10</p> <p>3</p>	<p>39186 ²⁶ (41285)</p>  <p>MALE FULLY INSULATED 12-10</p> <p>3</p>	<p>21951 ²⁷</p>  <p>1/4 FEMALE 12-10</p> <p>3</p>	<p>21953 ²⁸</p>  <p>1/4 MALE 12-10</p> <p>3</p>	<p>²⁹</p>	<p>³⁰</p>	<p>20788 ³¹</p>  <p>SCOTCHLOK 18 - 14</p> <p>5</p>	<p>20786 ³²</p>  <p>T - TAP 18 - 14</p> <p>3</p>

LET US HELP YOU MAKE THE CONNECTION

PART # 3000



NYLON TERMINALS



J & B FLEET-INDUSTRIAL SUPPLY
PHONE: 330-821-6342

21891 8-10 RING 22-18 10	21909 8-10 RING 16-14 10	21910 12-1/4 RING 16-14 10	21911 1/4-5/16 RING 16-14 10	21912 5/16-3/8 RING 16-14 10	21928 8-10 RING 12-10 10
21929 12-1/4 RING 12-10 10	21930 1/4-5/16 RING 12-10 10	21932 5/16-3/8 RING 12-10 10	21934 7/16-1/2 RING 12-10 10	21952 1/4 MALE 16-14 10	21950 1/4 FEMALE 16-14 10
21903 BUTT CONN 22-18 10	21921 BUTT CONN 16-14 10	21942 BUTT CONN 12-10 10	22066 SNAP PLUG 16-14 10	20003 FEMALE PLUG 16-14 10	21915 8-10 FORK 16-14 10





















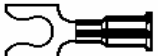









J&B Fleet - Industrial Supply

22428 Harrisburg-Westville Rd. Alliance, Ohio 44601 Phone: (330) 821-6342 Fax: (330) 821-0411

www.jbfleet.com

PART # 2133

PLASTIC & NYLON TERMINALS

<p>22291 (41268)</p>  <p>NYLON FEMALE FULLY INSUL 16-14</p>	<p>22290 (41269)</p>  <p>NYLON MALE FULLY INSUL 16-14</p>	<p>20728 (24757)</p>  <p>PLASTIC FEMALE 16-14</p>	<p>20727 (24756)</p>  <p>PLASTIC MALE 16-14</p>	<p>20792 (24731)</p>  <p>3-WAY CONNECTOR W/SEALANT</p>	<p>21901 (24730)</p>  <p>NYLON 8-10 FORK 22-18</p>	<p>20694 (24727)</p>  <p>PLASTIC 8-10 RING 22-18</p>	<p>21903 (41244)</p>  <p>NYLON BUTT CONNECT 22-18</p>
<p>22066 (41258)</p>  <p>MALE SNAP PLUG 16-14</p>	<p>21917 (41258)</p>  <p>NYLON 8-10 FORK 16-14</p>	<p>20705 (41252)</p>  <p>PLASTIC 3/8 RING 16-14</p>	<p>21911 (41252)</p>  <p>NYLON 5/16 RING 16-14</p>	<p>20698 (24731)</p>  <p>PLASTIC 1/4 RING 16-14</p>	<p>20697 (24730)</p>  <p>PLASTIC 8-10 RING 16-14</p>	<p>20696 (24729)</p>  <p>PLASTIC 6-8 RING 16-14</p>	<p>21921 (41260)</p>  <p>NYLON BUTT CONNECT 16-14</p>
<p>20003 (24726)</p>  <p>FEMALE RECEPTACLE 16-14</p>	<p>21938 (24735)</p>  <p>NYLON 8-10 FORK 12-10</p>	<p>20703 (24726)</p>  <p>PLASTIC 1/2 RING 12-10</p>	<p>20702 (24735)</p>  <p>PLASTIC 3/8 RING 12-10</p>	<p>20701 (24734)</p>  <p>PLASTIC 5/16 RING 12-10</p>	<p>20700 (24733)</p>  <p>PLASTIC 1/4 RING 12-10</p>	<p>20699 (24732)</p>  <p>PLASTIC 8-10 RING 12-10</p>	<p>21942 (41280)</p>  <p>NYLON BUTT CONNECT 12-10</p>
<p>41284 (24732)</p>  <p>NYLON FEMALE FULLY INSUL 12-10</p>	<p>41285 (24732)</p>  <p>NYLON MALE FULLY INSUL 12-10</p>	<p>20732 (24732)</p>  <p>PLASTIC FEMALE 12-10</p>	<p>20731 (24732)</p>  <p>PLASTIC MALE 12-10</p>			<p>20788 (24732)</p>  <p>SCOTCHLOCK 18-14</p>	<p>20786 (24732)</p>  <p>T - TAP 18-14</p>

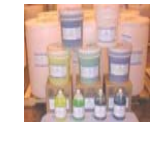











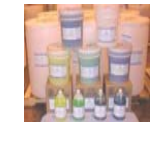







J&B Fleet - Industrial Supply
 22428 Harrisburg-Westville Rd. Alliance, Ohio 44601 Phone: (330) 821-6342 Fax: (330) 821-0411

www.jbfleet.com

PART # 2192

PLASTIC TERMINALS



1	2 41210  8-10 RING #8 GAUGE	3 41212  12-1/4 RING #8 GAUGE	4	5 22000  5/16-3/8 RING #8 GAUGE	6 22002  7/16-1/2 RING #8 GAUGE
5	5	5	5	5	5
7	8	9	10	11	12 22004  # 8 GA BUTT CONNECTOR
7	8	9	10	11	10
13 41218  8-10 RING #6 GAUGE	14 41219  12-1/4 RING #6 GAUGE	15 41220  1/4-5/16 RING #6 GAUGE	16 41221  5/16-3/8 RING #6 GAUGE	17 41223  7/16-1/2 RING #6 GAUGE	18 41214  # 6 GA BUTT CONNECTOR
5	5	5	5	5	5
19 41230  12-1/4 RING #4 GAUGE	20 41231  1/4-5/16 RING #4 GAUGE	21 41232  5/16-3/8 RING #4 GAUGE	22	23	24 41226  # 4 GA BUTT CONNECTOR
3	3	3			5



























J&B Fleet - Industrial Supply

www.jbfleet.com

22428 Harrisburg-Westville Rd. Alliance, Ohio 44601 Phone: (330) 821-6342 Fax: (330) 821-0411

PART # 2049

PLASTIC TERMINALS

<p>20694 ¹ (24727)</p>  <p>8-10 RING 22-18</p> <p>15</p>	<p>20696 ² (24729)</p>  <p>4-6 RING 16-14</p> <p>15</p>	<p>20697 ³ (24730)</p>  <p>8-10 RING 16-14</p> <p>25</p>	<p>20698 ⁴ (24731)</p>  <p>12-1/4 RING 16-14</p> <p>10</p>	<p>20699 ⁵ (24732)</p>  <p>8-10 RING 12-10</p> <p>25</p>	<p>25127 ⁶</p>  <p>WIRE NUT CONNECTOR BLUE</p> <p>10</p>
<p>20700 ⁷ (24733)</p>  <p>12-1/4 RING 12-10</p> <p>10</p>	<p>20701 ⁸ (24734)</p>  <p>1/4-5/16 RING 12-10</p> <p>10</p>	<p>20702 ⁹ (24735)</p>  <p>5/16-3/8 RING 12-10</p> <p>10</p>	<p>20703 ¹⁰ (24736)</p>  <p>7/16-1/2 RING 12-10</p> <p>5</p>	<p>20629 ¹¹ (24741)</p>  <p>8-10 FORK 12-10</p> <p>25</p>	<p>25128 ¹²</p>  <p>WIRE NUT CONNECTOR ORANGE</p> <p>10</p>
<p>20792 ¹³</p>  <p>3-WAY CONNECTOR W/ SEALANT</p> <p>3</p>	<p>20625 ¹⁴ (24738)</p>  <p>8-10 FORK 22-18</p> <p>10</p>	<p>20627 ¹⁵ (24740)</p>  <p>8-10 FORK 16-14</p> <p>25</p>	<p>20735 ¹⁶ (24746)</p>  <p>BUTT CONNECTOR 22-18</p> <p>25</p>	<p>20736 ¹⁷ (24747)</p>  <p>BUTT CONNECTOR 16-14</p> <p>25</p>	<p>25129 ¹⁸</p>  <p>WIRE NUT CONNECTOR YELLOW</p> <p>10</p>
<p>20737 ¹⁹ (24748)</p>  <p>BUTT CONNECTOR 12-10</p> <p>25</p>	<p>20728 ²⁰ (24757)</p>  <p>1/4 FEMALE 16-14</p> <p>25</p>	<p>20727 ²¹ (24756)</p>  <p>1/4 MALE 16-14</p> <p>25</p>	<p>20003 ²²</p>  <p>FEMALE PLUG 16-14</p> <p>10</p>	<p>20741 ²³ (24755)</p>  <p>SNAP PLUG 16-14</p> <p>10</p>	<p>20788 ²⁴</p>  <p>SCOTCHLOK CONNECTOR 18-14</p> <p>10</p>



LET US HELP YOU MAKE THE CONNECTION

PART # 3001



PLASTIC TERMINALS



J & B FLEET-INDUSTRIAL SUPPLY
PHONE: 330-821-6342

20694 8-10 RING 22-18 10	20697 8-10 RING 16-14 10	20698 12 - 1/4 RING 16-14 10	20705 3/8 RING 16-14 10	20629 8-10 FORK 12-10 10	20699 8-10 RING 12-10 10
20700 12 - 1/4 RING 12-10 10	20701 1/4 - 5/16 RING 12-10 10	20702 5/16 - 3/8 RING 12-10 10	20703 7/16 - 1/2 RING 12-10 10	20727 1/4 MALE 16-14 10	20728 1/4 FEMALE 16-14 10
20735 BUTT CONN 22-18 10	20736 BUTT CONN 16-14 10	20737 BUTT CONN 12-10 10	20741 SNAP PLUG 16-14 10	20003 FEMALE PLUG 16-14 10	20627 8-10 FORK 16-14 10

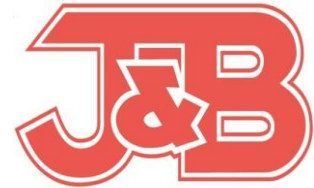

J&B Fleet - Industrial Supply

www.jbfleet.com

22428 Harrisburg-Westville Rd. Alliance, Ohio 44601 Phone: (330) 821-6342 Fax: (330) 821-0411

PART # 2224

NON-INSULATED TERMINALS

 39475 1 25 22-18 BUTT CONNECTOR	 39490 2 25 22-18 # 6 RING	 39491 3 25 22-18 # 10 RING	 39492 4 25 22-18 # 10 FORK	 20744 5 10 16-14 8-10 FLAG	 39489 13 10 16-14 1/4 90 FLAG	 55914 7 25 22-18 FEMALE 1/4 STUD	 55915 8 25 22-18 MALE 1/4 STUD
 39476 9 25 16-14 BUTT CONNECTOR	 39493 10 25 16-14 # 6 RING	 39494 11 25 16-14 # 10 RING	 39495 12 25 16-14 1/4 RING	 39497 14 10 16-14 # 10 FORK	 55903 15 25 16-14 FEMALE 1/4 STUD	 55908 16 25 16-14 MALE 1/4 STUD	
 39477 17 25 12-10 BUTT CONNECTOR	 39498 18 25 12-10 # 10 RING	 39499 19 25 12-10 1/4 RING	 39500 20 10 12-10 5/16 RING	 39501 21 10 12-10 3/8 RING	 39502 22 25 12-10 # 10 FORK	 55901 23 25 12-10 FEMALE 1/4 STUD	 55909 24 25 12-10 MALE 1/4 STUD
 55897 25 10 8 GA BUTT CONNECTOR	 55898 26 10 8 GA # 10 RING	 55899 27 10 8 GA 1/4 RING	 55868 28 10 8 GA 3/8 RING	 55869 29 10 8 GA 1/2 RING	30	31	32

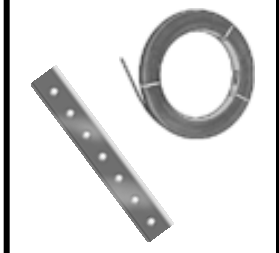

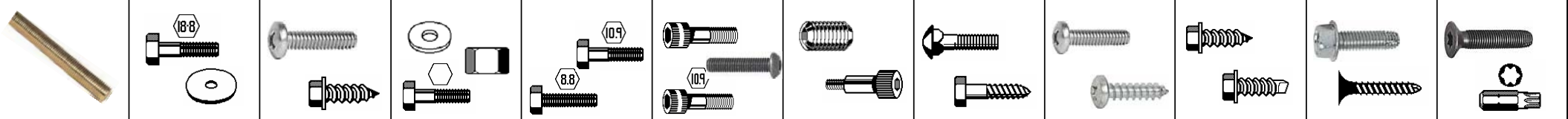

























J&B Fleet - Industrial Supply

22428 Harrisburg-Westville Rd. Alliance, Ohio 44601 Phone: (330) 821-6342 Fax: (330) 821-0411

www.jbfleet.com

PART # 2211

SHRINK TERMINALS

<p>39474 ¹</p>  <p>12-10 GA BUTT CONNECTOR</p> <p>10</p>	<p>39466 ²</p>  <p>12-10 GA 8-10 STUD</p> <p>10</p>	<p>39472 ³</p>  <p>16-14 GA BUTT CONNECTOR</p> <p>10</p>	<p>39462 ⁴</p>  <p>16-14 GA 8-10 STUD</p> <p>10</p>	<p>39470 ⁵</p>  <p>22-18 GA BUTT CONNECTOR</p> <p>10</p>	<p>42126 ⁶</p>  <p>22-18 GA FEMALE CONNECTOR</p> <p>5</p>
<p>42132 ⁷</p>  <p>12-10 GA 1/2 STUD</p> <p>5</p>	<p>39456 ⁸</p>  <p>12-10 GA FEMALE CONNECTOR</p> <p>5</p>	<p>39465 ⁹</p>  <p>16-14 GA 5/16-3/8 STUD</p> <p>5</p>	<p>39455 ¹⁰</p>  <p>16-14 GA MALE CONNECTOR</p> <p>5</p>	<p>42130 ¹¹</p>  <p>22-18 1/4 STUD</p> <p>10</p>	<p>42130 ¹¹</p>  <p>22-18 1/4 STUD</p> <p>10</p>
<p>39468 ¹³</p>  <p>12-10 GA 5/16-3/8 STUD</p> <p>5</p>	<p>39457 ¹⁴</p>  <p>12-10 GA MALE CONNECTOR</p> <p>5</p>	<p>39464 ¹⁵</p>  <p>16-14 GA 5/16 STUD</p> <p>10</p>	<p>39454 ¹⁶</p>  <p>16-14 GA FEMALE CONNECTOR</p> <p>5</p>	<p>39458 ¹⁷</p>  <p>22-18 GA 8-10 STUD</p> <p>10</p>	<p>39458 ¹⁷</p>  <p>22-18 GA 8-10 STUD</p> <p>10</p>
<p>39467 ¹⁹</p>  <p>12-10 GA 12-1/4 STUD</p> <p>10</p>	<p>41907 ²⁰</p>  <p>18-10 AWG CLOSED-END CONNECTOR</p> <p>5</p>	<p>39463 ²¹</p>  <p>16-14 GA 12-1/4 STUD</p> <p>10</p>	<p>41906 ²²</p>  <p>22-14 AWG CLOSED-END CONNECTOR</p> <p>5</p>	<p>42128 ²³</p>  <p>22-18 GA MALE CONNECTOR</p> <p>5</p>	<p>42128 ²³</p>  <p>22-18 GA MALE CONNECTOR</p> <p>5</p>

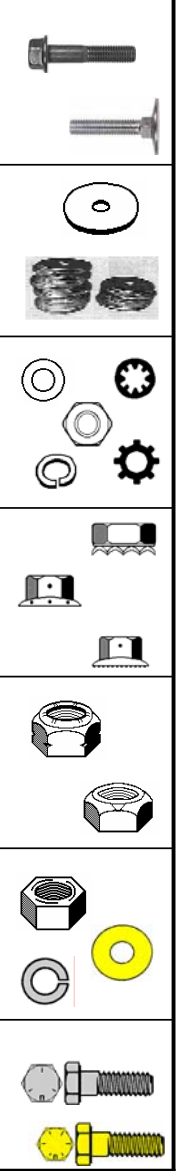

LET US HELP YOU MAKE THE CONNECTION

PART # 3002

SHRINK TERMINALS



J & B FLEET-INDUSTRIAL SUPPLY
PHONE: 330-821-6342



39454 16-14 FEMALE CONNECTOR 5	39455 16-14 MALE CONNECTOR 5	39470 22-18 BUTT CONNECTOR 5	39472 16-14 BUTT CONNECTOR 5	39474 12-10 BUTT CONNECTOR 5	
39458 8-10 RING 22-18 5	39462 8-10 RING 16-14 5	39463 1/4 RING 16-14 5	39466 8-10 RING 12-10 5	39467 1/4 RING 12-10 5	39468 3/8 RING 12-10 5













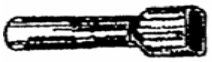









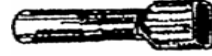

J&B Fleet - Industrial Supply

22428 Harrisburg-Westville Rd. Alliance, Ohio 44601 Phone: (330) 821-6342 Fax: (330) 821-0411

www.jbfleet.com

PART # 2134

SHRINK TERMINALS

<p>42126 ¹</p>  <p>22-18 FEMALE</p> <p>5</p>	<p>42128 ²</p>  <p>22-18 MALE</p> <p>5</p>	<p>42130 ³</p>  <p>22-18 1/4 RING</p> <p>5</p>	<p>39458 ⁴</p>  <p>22-18 10 RING</p> <p>5</p>	<p>39470 ⁵</p>  <p>22-18 BUTT</p> <p>10</p>	<p>42123 ⁶</p>  <p>STEP DOWN BUTT 22-18 to 16-14</p> <p>5</p>
<p>39465 ⁷</p>  <p>16-14 3/8 RING</p> <p>5</p>	<p>39464 ⁸</p>  <p>16-14 5/16 RING</p> <p>5</p>	<p>39463 ⁹</p>  <p>16-14 1/4 RING</p> <p>5</p>	<p>39462 ¹⁰</p>  <p>16-14 10 RING</p> <p>5</p>	<p>39472 ¹¹</p>  <p>16-14 BUTT</p> <p>10</p>	<p>42124 ¹²</p>  <p>STEP DOWN BUTT 16-14 to 12-10</p> <p>5</p>
<p>39454 ¹³</p>  <p>16-14 FEMALE</p> <p>5</p>	<p>39455 ¹⁴</p>  <p>16-14 MALE</p> <p>5</p>	<p>39460 ¹⁵</p>  <p>16-14 10 FORK</p> <p>5</p>	<p>39456 ¹⁶</p>  <p>12-10 FEMALE</p> <p>5</p>	<p>39457 ¹⁷</p>  <p>12-10 MALE</p> <p>5</p>	<p>42134 ¹⁸</p>  <p>16-14 M BULLET</p> <p>5</p>
<p>42132 ¹⁹</p>  <p>12-10 1/2 RING</p> <p>5</p>	<p>39468 ²⁰</p>  <p>12-10 3/8 RING</p> <p>5</p>	<p>39467 ²¹</p>  <p>12-10 1/4 RING</p> <p>5</p>	<p>39466 ²²</p>  <p>12-10 10 RING</p> <p>5</p>	<p>39474 ²³</p>  <p>12-10 BUTT</p> <p>10</p>	<p>42136 ²⁴</p>  <p>16-14 F BULLET</p> <p>5</p>

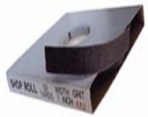



































J&B Fleet - Industrial Supply

www.jbfleet.com

22428 Harrisburg-Westville Rd. Alliance, Ohio 44601 Phone: (330) 821-6342 Fax: (330) 821-0411

PART # 2228

SHRINK TERMINALS

 39443 ¹ 22-24GA BUTT CONNECTOR 5	 39458 ² 20-18 GA 8-10 STUD 5	 42130 ³ 20-18 GA 1/4 STUD 4	 42126 ⁴ 20-18 GA FEMALE CONNECTOR 4	 42128 ⁵ 20-18 GA MALE CONNECTOR 4	 39412 ⁶ 20-18 GA FORK 5	 39470 ⁷ 20-18 GA BUTT CONNECTOR 5	 39415 ⁸ 16-14 GA 8 STUD 5
 39462 ⁹ 16-14 GA 10 STUD 5	 39463 ¹⁰ 16-14 GA 1/4 STUD 5	 39464 ¹¹ 16-14 GA 5/16 STUD 5	 39465 ¹² 16-14 GA 3/8 STUD 5	 39454 ¹³ 16-14 GA FEMALE CONNECTOR 5	 39455 ¹⁴ 16-14 GA MALE CONNECTOR 5	 39408 ¹⁵ 16-14 GA FEMALE CONNECTOR 5	 39407 ¹⁶ 16-14 GA MALE CONNECTOR 5
 39460 ¹⁷ 16-14 GA 8-10 FORK 5	 42136 ¹⁸ 16-14 GA FEMALE BULLET 5	 42134 ¹⁹ 16-14 GA MALE BULLET 5	 39472 ²⁰ 16-14 GA BUTT CONNECTOR 10	 42123 ²¹ 21-18 TO 16-14 STEP DOWN BUTT CONNECTOR 3	 42124 ²² 16-14 TO 12-10 STEP DOWN BUTT CONNECTOR 3	 39413 ²³ 12-10 GA 8 STUD 5	 39466 ²⁴ 12-10 GA 10 STUD 5
 39467 ²⁵ 12-10 GA 1/4" STUD 5	 39414 ²⁶ 12-10 GA 5/16" STUD 5	 39468 ²⁷ 12-10 GA 3/8" STUD 4	 42132 ²⁸ 12-10 GA 1/2" STUD 4	 39456 ²⁹ 12-10 GA FEMALE CONNECTOR 4	 39457 ³⁰ 12-10 GA MALE CONNECTOR 4	 39474 ³¹ 12-10 GA BUTT CONNECTOR 5	 39411 ³² 12-10 GA FORK 5



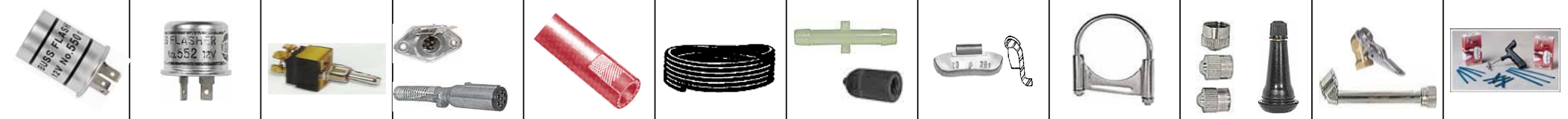

J&B Fleet - Industrial Supply

22428 Harrisburg-Westville Rd. Alliance, Ohio 44601 Phone: (330) 821-6342 Fax: (330) 821-0411

www.jbfleet.com

PART # 2203

WIRE NUTS

 <p>25129 1</p> <p>10 18-10 PLASTIC YELLOW</p>	 <p>41177 2</p> <p>10 22-12 COMBO NUT ORANGE/BLUE</p>	 <p>25146 3</p> <p>10 14-6 PLASTIC WING BLUE</p>	<p>4</p>
 <p>25128 5</p> <p>10 22-14 PLASTIC ORANGE</p>	 <p>22217 6</p> <p>10 16-10 SOFT PLASTIC RED</p>	 <p>25145 7</p> <p>10 18-8 PLASTIC WING GRAY</p>	<p>8</p>
 <p>25127 9</p> <p>10 22-14 PLASTIC BLUE</p>	 <p>22216 10</p> <p>10 18-12 SOFT PLASTIC YELLOW</p>	 <p>41179 11</p> <p>5 14-6 COMBO NUT BLUE/GREY</p>	<p>12</p>
 <p>25126 13</p> <p>10 22-16 PLASTIC GRAY</p>	 <p>25130 14</p> <p>10 18-10 PLASTIC RED</p>	 <p>41178 15</p> <p>10 18-8 COMBO NUT RED/YELLOW</p>	 <p>41176 16</p> <p>5 22-8 SEALED WIRE NUT</p>



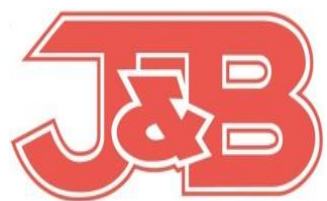

PART # 2010

J&B Fleet - Industrial Supply

22428 Harrisburg-Westville Rd. Alliance, Ohio 44601 Phone: (330) 821-6342 Fax: (330) 821-0411

www.jbfleet.com

DELPHI PACKARD TERMINALS



42308	42317	42311	42320
3 CONTACT TOWER 2	3 CONTACT SHROUD 2		
42307	42316	6 CONTACT TOWER 2	6 CONTACT SHROUD 2
2 CONTACT TOWER 2	2 CONTACT SHROUD 2	42309	42318
42306	42315	4 CONTACT TOWER 2	4 CONTACT SHROUD 2
1 CONTACT TOWER 2	1 CONTACT SHROUD 2		
42341	42333	42334	42335
REMOVAL TOOL 1	20-18 FEMALE 10	16-14 FEMALE 10	12 GAUGE FEMALE 10
42340	42330	42331	42332
CAVITY PLUG 10	20-18 MALE 10	16-14 MALE 10	12 GAUGE MALE 10
42300	42301	42302	42303
CABLE DIA MM 1.70-1.29	CABLE DIA MM 2.80-2.03	CABLE DIA MM 3.49-2.81	CABLE DIA MM 4.30-3.45
RED SEAL 10	GREEN SEAL 10	GRAY SEAL 10	BLUE SEAL 10

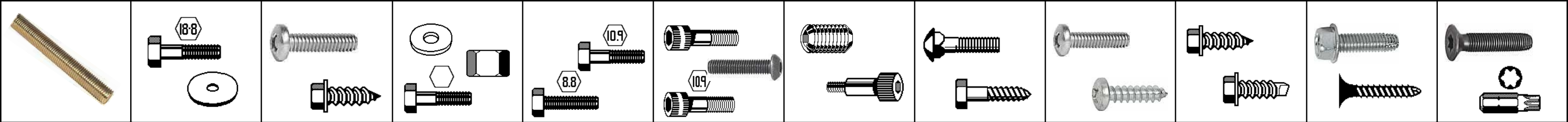







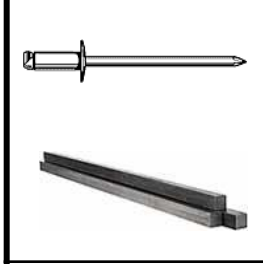
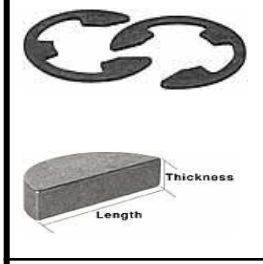
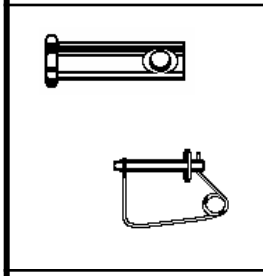
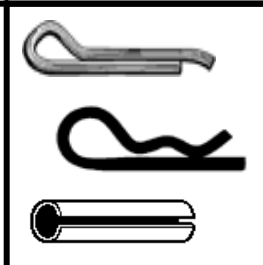
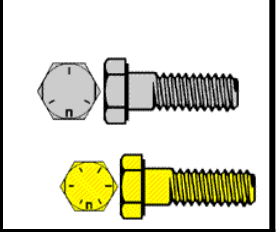
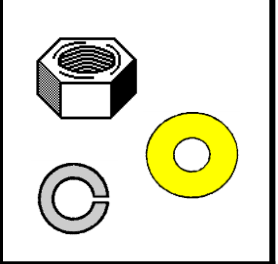
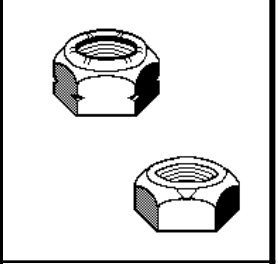
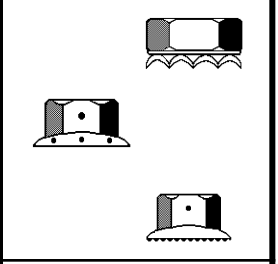
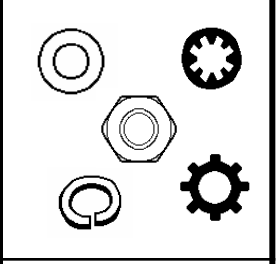
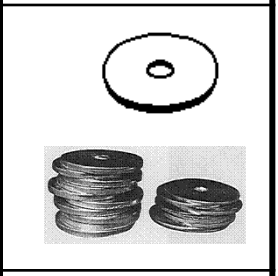





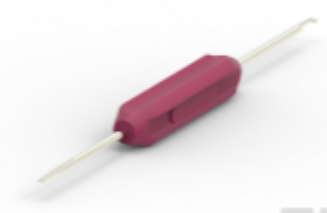

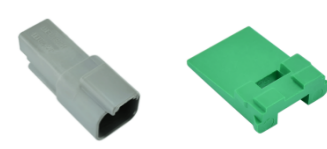
J&B Fleet - Industrial Supply
 22428 Harrisburg-Westville Rd. Alliance, Ohio 44601 Phone: (330) 821-6342 Fax: (330) 821-0411

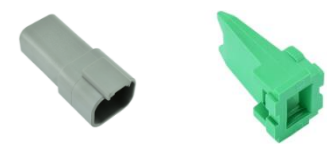
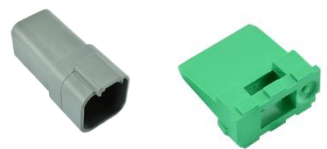
www.jbfleet.com

Deutsch Terminals DT Series

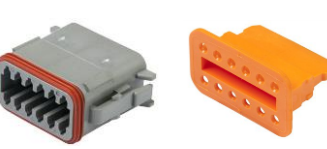
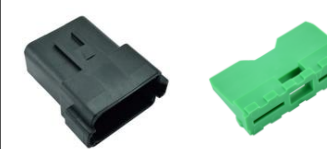

 #16-18 GA PIN RECEPTACLE 10	 #20-16 GA PIN PLUG 10	 #14 GA PIN RECEPTACLE 10	 #14 GA PIN PLUG 10	 SEALING PLUG 10	 57129 REMOVAL TOOL  57130 REMOVAL TOOL  57131 JIFFY SPLICE 1 OF EACH
 2 WAY HOUSING & WEDGE RECEPTACLE 4	 3 WAY HOUSING & WEDGE RECEPTACLE 4	 4 WAY HOUSING & WEDGE RECEPTACLE 4	 6 WAY HOUSING & WEDGE RECEPTACLE 2	 8 WAY HOUSING & WEDGE RECEPTACLE 2	
 2 WAY HOUSING & WEDGE PLUGS 2	 3 WAY HOUSING & WEDGE PLUGS 2	 4 WAY HOUSING & WEDGE PLUGS 2	 6 WAY HOUSING & WEDGE PLUGS 2	 8 WAY HOUSING & WEDGE PLUGS 2	
 12 WAY HOUSING & WEDGE PLUGS 2	 12 WAY HOUSING & WEDGE RECEPTACLE 2				



J&B Fleet - Industrial Supply









22428 Harrisburg-Westville Rd. Alliance, Ohio 44601 Phone: (330) 821-6342 Fax: (330) 821-0411

www.jbfleet.com



PART # 2120

SHRINK TUBING

<p>38751 3/16 BLACK</p>  <p>PRE-SHRINK ID .187 POST-SHRINK ID .059</p>	<p>57051 1 3/16 RED</p>  <p>PRE-SHRINK ID .375 POST-SHRINK ID .135</p>	<p>38754 3/8 BLACK</p>  <p>PRE-SHRINK ID .750 POST-SHRINK ID .250</p>	<p>57053 2 3/8 RED</p>  <p>PRE-SHRINK ID .750 POST-SHRINK ID .250</p>	
<p>38750 1/8 BLACK</p>  <p>PRE-SHRINK ID .125 POST-SHRINK ID .023</p>	<p>57050 5 1/8 RED</p>  <p>PRE-SHRINK ID .250 POST-SHRINK ID .080</p>	<p>38660 14 - 6 BLACK</p>  <p>PRE-SHRINK ID .400 POST-SHRINK ID .150</p>	<p>40362 3 8 - 1 RED</p>  <p>PRE-SHRINK ID 1.100 POST-SHRINK ID .375</p>	<p>38664 2 - 4/O BLACK</p>  <p>PRE-SHRINK ID 1.100 POST-SHRINK ID .375</p>



LET US HELP YOU MAKE THE CONNECTION

PART # 3003

HEAT SHRINK TUBING



J & B FLEET-INDUSTRIAL SUPPLY
PHONE: 330-821-6342



38750 BLACK	38751 BLACK	38752 BLACK	38754 BLACK	38660 BLACK	57054 RED
1/8"	3/16"	1/4"	3/8"	1/2"	1/2"
57050 RED	57051 RED	57052 RED	57053 RED		
4	4	2	2	2	2



J&B Fleet - Industrial Supply

22428 Harrisburg-Westville Rd. Alliance, Ohio 44601 Phone: (330) 821-6342 Fax: (330) 821-0411

www.jbfleet.com

PART # 2105

WHITE CABLE TIES



25 **38952** 1

3/32 X 4" TIES

25 **38955** 2

1/8 X 5-1/2" TIES

25 **38956** 3

3/16 X 7-1/2" TIES

25 **12078** 4

3/16 X 7-1/2" TIES WITH MOUNTING HOLE

25 **38953** 5

3/16 X 11" TIES

25 **38957** 6

3/16 X 14" TIES

15 **38958** 7

5/16 X 14" HEAVY DUTY

15 **38958** 8

5/16 X 14" HEAVY DUTY











J&B Fleet - Industrial Supply

22428 Harrisburg-Westville Rd. Alliance, Ohio 44601 Phone: (330) 821-6342 Fax: (330) 821-0411

www.jbfleet.com

PART # 2186

BLACK CABLE TIES

25	<p>38950</p>  <p>3/32 X 3-3/4" TIES</p>	1	25	<p>38945</p>  <p>1/8 X 5-1/2" TIES</p>	2
25	<p>38959</p>  <p>3/16 X 7" TIES</p>	3	25	<p>12078</p>  <p>3/16 X 7-1/16" WHITE TIES WITH MOUNTING HOLE</p>	4
25	<p>38947</p>  <p>3/16 X 11" TIES</p>			5	
25	<p>38951</p>  <p>3/16 X 14-1/4" TIES</p>			6	
25	<p>38946</p>  <p>7/32 X 5-1/2" RELEASABLE</p>			7	
15	<p>38954</p>  <p>5/16 X 14" HEAVY DUTY</p>			8	



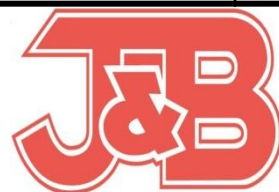

J&B Fleet - Industrial Supply







22428 Harrisburg-Westville Rd. Alliance, Ohio 44601 Phone: (330) 821-6342 Fax: (330) 821-0411

www.jbfleet.com

PART# 2288

BLACK CABLE TIES



25	<p>38954</p>  <p>5/16 X 14" TIES</p>
25	<p>38954</p>  <p>5/16 X 14" TIES</p>
25	<p>38951</p>  <p>3/16 X 14" TIES</p>
25	<p>38947</p>  <p>3/16 X 11" TIES</p>
25	<p>38959</p>  <p>3/16 X 7" TIES</p>
25	<p>38945</p>  <p>1/8 X 5" TIES</p>
15	<p>WHITE OR BLACK</p>  <p>40027 NYLON TIE MOUNT BLACK ADHESIVE CABLE TIE MOUNTS</p> <p>ADHESIVE BACK</p>



J&B Fleet - Industrial Supply











22428 Harrisburg-Westville Rd. Alliance, Ohio 44601 Phone: (330) 821-6342 Fax: (330) 821-0411

www.jbfleet.com

PART # 2187

COLORED CABLE TIES



<p>25</p> <p>38956</p>  <p>3/16 X 7-1/2 WHITE</p>	<p>25</p> <p>38959</p>  <p>3/16 X 7-1/2 BLACK</p>
<p>25</p> <p>41913</p>  <p>3/16 X 7-1/2 BROWN</p>	<p>25</p> <p>41914</p>  <p>3/16 X 7-1/2 RED</p>
<p>25</p> <p>41915</p>  <p>3/16 X 7-1/2 ORANGE</p>	<p>25</p> <p>41916</p>  <p>3/16 X 7-1/2 YELLOW</p>
<p>25</p> <p>41917</p>  <p>3/16 X 7-1/2 GREEN</p>	<p>25</p> <p>41918</p>  <p>3/16 X 7-1/2 BLUE</p>
<p>25</p> <p>41919</p>  <p>3/16 X 7-1/2 PURPLE</p>	<p>25</p> <p>41921</p>  <p>3/16 X 7-1/2 NEON PINK</p>



LET US HELP YOU MAKE THE CONNECTION

PART# 3105

COLOR TIE ASSORTMENT



J & B FLEET-INDUSTRIAL SUPPLY
PHONE: 330-821-6342

86121
3/32 X 4
41914
3/16 X 7.5

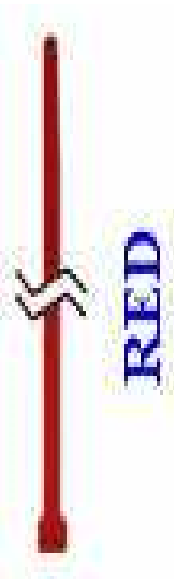

25

86122
3/32 X 4
41915
3/16 X 7.5



25

86123
3/32 X 4
41916
3/16 X 7.5



25

86124
3/32 X 4
41917
3/16 X 7.5

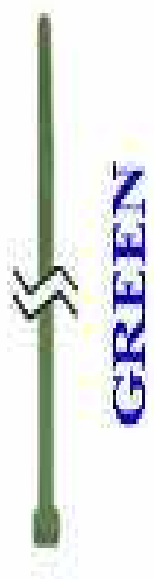

25

86125
3/32 X 4
41918
3/16 X 7.5



25

86126
3/32 X 4
41919
3/16 X 7.5



25

LET US HELP YOU MAKE THE CONNECTION

PART# 3097

COLOR CABLE TIES



J & B FLEET-INDUSTRIAL SUPPLY
PHONE: 330-821-6342

86121

RED

3/32 X 4

50

86122

ORANGE

3/32 X 4

50

86123

YELLOW

3/32 X 4

50

86124

GREEN

3/32 X 4

50

86125

BLUE

3/32 X 4

50

86126

PURPLE

3/32 X 4

50