

# HEX HEAD CAP SCREWS

## SMALL PACKS

Grade 5

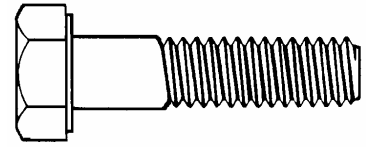

- Duraplate finish protects against rust and corrosion.
- 1038 Steel - double heat treated.
- Headmarked for complete traceability.

1/4" DIAMETER			
J&B #	SAE	LENGTH	QTY
3006	3506	1/2	50
3010	3510	3/4	50
3012	3512	1	50
3014	3514	1-1/4	25
3016	3516	1-1/2	25
3018		1-3/4	25
3020	3520	2	25
3022		2-1/4	25
3024	3524	2-1/2	25
3026		2-3/4	20
3028	3528	3	20
3032	3532	3-1/2	20
	3536	4	20

3/8" DIAMETER			
J&B #	SAE	LENGTH	QTY
3106		1/2	25
3110	3610	3/4	25
3112	3612	1	25
3114		1-1/4	25
3116	3616	1-1/2	20
3118		1-3/4	20
3120	3620	2	20
3122		2-1/4	15
3124	3624	2-1/2	15
3126		2-3/4	15
3128	3628	3	15
3132	3632	3-1/2	15
3136	3636	4	10
3138		4-1/2	10
3140		5	10
3142		5-1/2	10
3144		6	10

5/16" DIAMETER			
J&B #	SAE	LENGTH	QTY
3056	3556	1/2	50
3060	3560	3/4	50
3062	3562	1	25
3064		1-1/4	25
3066	3566	1-1/2	25
3068		1-3/4	25
3070	3570	2	25
3072		2-1/4	20
3074	3574	2-1/2	20
3076		2-3/4	20
3078	3578	3	15
3082	3582	3-1/2	15
3086	3586	4	15
3088		4-1/2	10
3090		5	10

# HEX HEAD CAP SCREWS

## SMALL PACKS

Grade 5

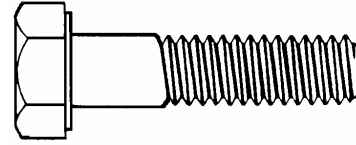

- Duraplate finish protects against rust and corrosion.
- 1038 Steel - double heat treated.
- Headmarked for complete traceability.

7/16" DIAMETER			
J&B #	SAE	LENGTH	QTY
3160		3/4	25
3162	3662	1	25
3164		1-1/4	20
3166	3666	1-1/2	20
3168		1-3/4	20
3170	3670	2	15
3172		2-1/4	15
3174	3674	2-1/2	15
3176		2-3/4	15
3178	3678	3	10
3182	3682	3-1/2	10
3186	3686	4	10
3188	3688	4-1/2	5
3190	3690	5	5
3192		5-1/2	5
3194		6	5

1/2" DIAMETER			
J&B #	SAE	LENGTH	QTY
3210		3/4	20
3212	3712	1	20
3214		1-1/4	20
3216	3716	1-1/2	20
3218		1-3/4	15
3220	3720	2	15
3222		2-1/4	15
3224	3724	2-1/2	15
3226		2-3/4	10
3228	3728	3	10
3232	3732	3-1/2	10
3236	3736	4	5
3238	3738	4-1/2	5
3240	3740	5	5
3242		5-1/2	5
3244		6	5

# BUMPER BOLTS

---

## ROUND HEAD

- Stainless steel capped for positive protection against weather.

J&B #	SIZE	QTY
10662	3/8-16 x 1	25
10665	7/16-14 x 1-1/4	25
10672	1/2-13 x 1-1/2	25

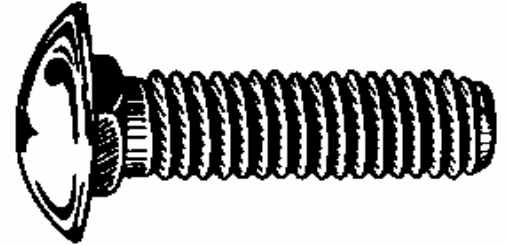

---

## PAN HEAD

- Stainless steel capped for positive protection against weather.

J&B #	SIZE	QTY
11860	3/8-16 x 1	25



J&B #	SIZE	QTY
11839	7/16-14 x 1-1/4	25

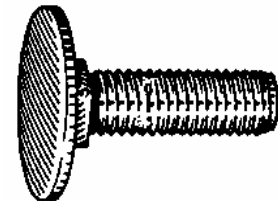

# BODY BOLTS

BLACK FINISH

## HEX SPIN LOCK

W/ Dog Point

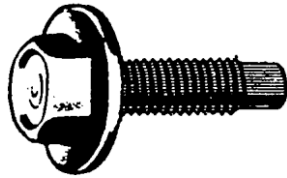

J&B#	SIZE	WASH. O.D.	QTY
12845	5/16-18 x 1	13/16	25
12847	5/16-18 x 1-1/4	13/16	25
12844	5/16-24 x 1	13/16	25

## HEX HEAD SEMS

W/ Dog Point

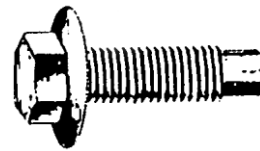

J&B#	SIZE	WASH. O.D.	QTY
13402	1/4-20 x 7/8	3/4	25
12504	1/4-20 x 1	5/8	25

## HEX SPIN LOCK

Without Dog Point

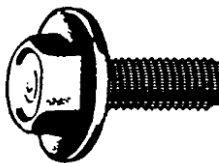

J&B#	SIZE	WASH. O.D.	QTY
12841	1/4-20 x 5/8	5/8	25

## HEX HEAD SEMS

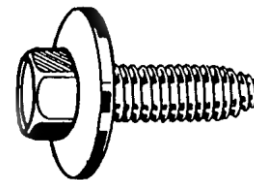

J&B#	SIZE	WASH. O.D.	QTY
45407	5/16-18 x 1	7/8	25
38468	3/8-16 x 1	1"	25
10377	3/8-16 x 1-1/2	1-1/8	25

## HEX HEAD SEMS

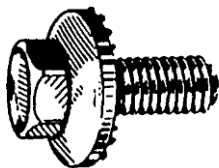

J&B#	SIZE	WASH. O.D.	QTY
10567	5/16-18 x 1	7/8	25

## HEX HEAD SEMS

W/ Dog Point

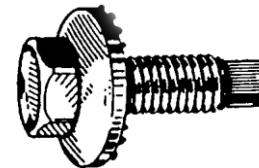

J&B#	SIZE	WASH. O.D.	QTY
10570	5/16-18 x 1-1/4	7/8	25

## HEX WASHER HEAD

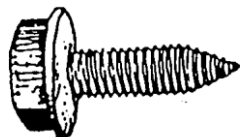

J&B#	SIZE	WASH. O.D.	QTY
12060	5/16-18 x 13/16	41/64	20
38499	5/16-18 x 3/4	21/32	100



# METRIC BODY BOLTS

---

## BLACK FINISH METRIC HEX HEAD SEMS

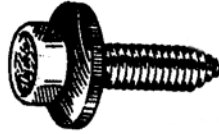

J&B #	SIZE	MATERIAL	WASH. OD	QTY
45410	M6-1.00 x 20mm	Phosphate	17mm	25
41841	M6-1.00 x 25mm	Phosphate	17mm	50
45418	M6-1.00 x 25mm	Phosphate	24mm	50
45888	M6-1.00 x 35mm	Phosphate	17mm	50
42004	M6-1.00 x 25mm	Black Polyseal	24mm	25
42008	M8-1.25 x 25mm	Phosphate	24mm	25
41882	M8-1.25 x 30mm	Phosphate	24mm	25
45802	M10-1.50 x 40mm	Phosphate	29mm	25

---

## METRIC HEX HEAD SEMS

W/ Dog Point

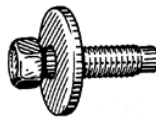

J&B #	SIZE	WASH. OD	QTY
42090	M6-1.00 x 22mm	19mm	25
45425	M6-1.00 x 28mm	19mm	25

---

## HEX WASHER HEAD

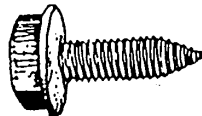

J&B #	SIZE	MATERIAL	WASH. OD	QTY
45814	M8-1.25 x 25mm	Black Polyseal	17mm	25

# BODY SHOP NUTS

## EXTRUDED "U" NUTS Standard

- Treated for corrosion resistance.
- High quality annealed steel.

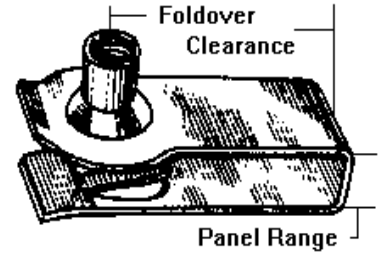

J&B #	THREAD	FOLDOVER CLEARANCE	PANEL RANGE	QTY
10525	1/4-20	1/2	.080 - .090	25
10527	1/4-20	3/4	.140 - .170	25
10530	5/16-18	9/16	.025 - .150	25
10556	5/16-18	9/16	.120 - .150	25
10536	5/16-18	27/32	.025 - .150	25
10533	3/8-16	1-1/8	.050 - .200	15

## EXTRUDED "U" NUTS Metric

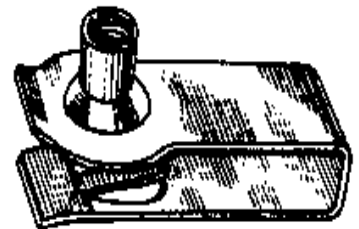

J&B #	THREAD	FOLDOVER CLEARANCE	PANEL RANGE	QTY
41876	6-1.0 mm	13.5 mm	.8 - 4.0 mm	50
42094	6-1.0 mm	13.5 mm	.8 - 4.0 mm	25
41878	6-1.0 mm	19.5 mm	.34 - 4.0 mm	25
42102	6-1.0 mm	19.5 mm	1.0 - 2.5 mm	50
10691	6.3 - 1.0 mm	13.5 mm	.8 - 4.0 mm	25
42000	8-1.25 mm	14.5 mm	.8 - 4.0 mm	25
41874	8-1.25 mm	20.0 mm	8 - 4.5 mm	25
42086	10-1.50 mm	19 mm	1.0 - 6.0 mm	25

## "J" TYPE CAGE NUTS

- High quality selected annealed steel.
- Heat treated at exacting temperatures to give maximum holding power and "spring back" action even after continuous use.















J&B #	THREAD	FOLDOVER CLEARANCE	PANEL RANGE	QTY
11654	1/4-20 (W/Square Nut)	1/2	.032 - .100	25
11610	5/16-18	15/32	.087 - .093	25
11637	3/8-16	9/16	.050 - .090	15

# BODY SHOP NUTS

## “U” & “J” TYPE NUTS

(Illustrations Actual Size)

- High quality selected annealed steel.
- Heat treated at exacting temperatures to give maximum holding power and “spring back” action.

J&B #	SCREW SIZE	PANEL RANGE	FOLDOVER CLEARANCE	QTY	
10414 (AVE5836)	# 8	.025 - .035	3/8	25	
10420 (AVE8337)	# 8	.025 - .040	3/8	25	
10327 (AVE9625)	# 6	.090 - .110	9/32	25	
10343 (AVE8341)	#10	.025 - .060	11/32	100	
11027 (AVE2346)	# 8	.025 - .040	9/32	25	
10421 (AVE24020)	# 8			25	
10347 (AVE2293)	1/4-20	.064 - .125	9/16	25	
10422 (AVE10065)	# 8	.025 - .150	3/8	25	
11705 (AVE3797)	#10	.045 - .062	13/32	25	
10425 (AVE2422)	#10	.025 - .064	3/8	25	
11024 (AVE8340)	#10	.025 - .062	9/32	25	
11034 (AVE3770)	#10	.030 - .037	3/8	25	



# BODY SHOP NUTS

---

## “U” & “J” TYPE NUTS

(Illustrations Actual Size)

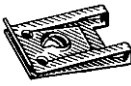
- High quality selected annealed steel.
- Heat treated at exacting temperatures to give maximum holding power and “spring back” action.

J&B #	SCREW SIZE	PANEL RANGE	FOLDOVER CLEARANCE	QTY	
10329 (AVE10666)	# 8	.025 - .035	11/32	25	
45522 (AVE9879)	# 8	.025 - .150	5/8	25	
45800 (AVE9880)	# 8	.025 - .150	3/8	100	

---











# BODY SHOP NUTS

## FLAT NUTS

(Illustrations Actual Size)

- High quality selected annealed steel.
- Heat treated at exacting temperatures to give maximum holding power and “spring back” action even after continuous use.

J&B #	STUD SIZE	QTY	
11036	1/16	50	
10485	5/64	50	
11037	3/32	50	
11038	7/64	50	
11039	1/8	50	
11040	5/32	50	
11042	3/16	50	
11041	5/32	50	

## CAGE NUTS

- Phosphatate plated.









J&B #	THREAD	PANEL RANGE	QTY
86065	1/4-20	.064 - .105	50
86066	5/16-18	.023 - .063	50
86064	M6-1.0	1.7mm – 2.7mm	25



# BODY SHOP NUTS

## BARREL NUTS

(Illustrations Actual Size)

J&B #	STUD SIZE	PANEL RANGE	HOLE SIZE	QTY	
10393	1/8	.025 - .045	3/16	50	
11053	1/8	.030 - .036	5/32	50	
11006	1/8	.040 - .045	3/16	50	
11004	1/8	.038 - .044	5/32	50	
10492	3/16	.036 - .046	1/4	25	
11009		.039 - .045	.267 x .116	50	
10496	1/4	.034 - .040	9/32	50	
11008	1/8	.035 - .100	3/16	50	
11605	3/32	.031 - .041	1/8 x 5/32	50	

# BODY SHOP

---

## WELL NUT

Neoprene with Captive Brass Nut

J&B #	SIZE	OVERALL LENGTH	HOLE SIZE	QTY
55892	6-32	.981	1/4	25
55893	8-32	.499	5/16	25
55894	10-24	.767	3/8	25
55895	10-32	.807	3/8	25
55896	1/4-20	1.051	1/2	25
40908	M6-1.0	.630	1/2	25

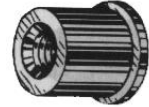

---

## DOOR HINGE REPAIR KIT

For GM,C/K Trucks & Full Size SUV '99 & up

- Economically repair worn out door hinge pins on vehicles with welded hinges without removing the hinge.
- Case hardened forged pins with dacromet (500 hour salt spray) finish.
- Bronze bushings, thru hardened washers and prevailing torq lock nuts.

\*\* Each kit contains...

2 pins  
2 bushings  
2 washers  
2 locknuts



J&B #	QTY
4238	1/KIT

# BODY SHOP NUTS

## SELF-THREADING NUTS

Zinc

J&B #	SIZE	WASHER O.D.	QTY
11534	1/8 Stud	17/32	100
12199	5/32 Stud	9/16	100
11535	3/16 Stud	5/8	100
11536	1/4 Stud	7/16	100
12217	5/16 Stud	7/8	50



## FLANGED PAL NUTS

Zinc

J&B #	SIZE	FLANGE	QTY
10623	10-24	3/4	100
10634	1/4-20	19/32	100
10719	1/4-20	13/16	100



## PUSHNUT BOLT RETAINER

For Threaded Fasteners

Phosphate

- Prevents screw or bolt from spinning.



J&B #	SIZE	O.D.	QTY
10370	1/4	1/2	100
10371	5/16	5/8	100
10372	3/8	25/32	100
10373	7/16	27/32	50
10374	1/2	15/16	50

## FLAT PUSH-ON RETAINER

For Non-Threaded Fasteners

Zinc

- No threads, notches or grooves required.



J&B #	SIZE	O.D.	QTY
10501	1/8	3/8	50

## PUSHNUT BOLT RETAINER

- \* Prevents screw or bolt from spinning.

For Threaded Fasteners

Dacromate



J&B #	SIZE	O.D.	QTY
42064	M8-1.25	24mm	50

# BODY NUTS

## HEX FLANGE NUT



J&B #	SIZE	FLANGE O.D.	QTY
42060	M8-1.25	17mm	25
45804	M10-1.50	21mm	25

## METRIC SPIN LOCK NUTS

With Serrations



J&B #	SIZE	O.D.	QTY
45852	M10-1.25	19mm	25

## FREE SPINNING WASHER NUT

Phosphate

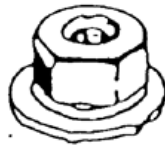

J&B #	SIZE	WASHER O.D.	HEX SIZE	QTY
41861	M6-1.0	16mm	10mm	25
10915	M6-1.0	19mm	11mm	25
10916	M8.0-1.25	24mm	13mm	25
40394	1/4-20	7/8	7/16	50









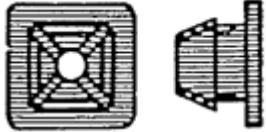

## FREE SPINNING WASHER NUT



J&B #	SIZE	WASHER O.D.	HEX SIZE	MATERIAL	QTY
45580	M6-1.0	18mm	10mm	PHOSPHATE	50
45581	M6-1.0	19mm	10mm	ZINC	50
45842	M6-1.0	20mm	10mm	PHOSPHATE	50
45403	1/4-20	5/8	7/16	ZINC	50
45404	5/16-18	3/4	1/2	PHOSPHATE	50
45405	3/8-16	7/8	9/16	PHOSPHATE	25







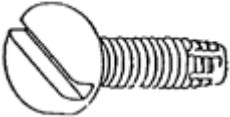

# LICENSE PLATE FASTENERS

## ZINC PLATED SCREWS



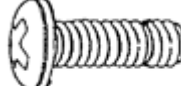
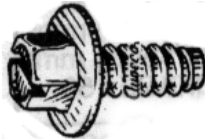



J&B #	DESCRIPTION	QTY	
10583	Hole: 3/8 Screw #14	100	
12069	14 x 3/4 Round Slotted Truss Head	100	
10589	1/4-20 x 3/4 Slotted Truss Head	100	
11301	14 x 3/4 Slotted Hex Washer Head	50	
46119	6-1.00 x 12mm Pan Head Phillips Black Nylon License Plate Screw	100	
46120	6-1.00 x 16mm Pan Head Phillips Black Nylon License Plate Screw	100	
46121	6-1.00 x 16mm Pan Head Phillips Black Nylon License Plate Screw	1000	
46122	6-1.00 x 20mm Pan Head Phillips Black Nylon License Plate Screw	100	
46123	6-1.00 x 20mm Pan Head Phillips Black Nylon License Plate Screw	1000	
46124	6-1.00 Nylon Hex Nut Black	100	

# LICENSE PLATE FASTENERS

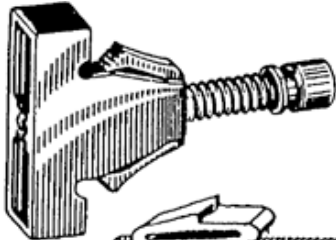
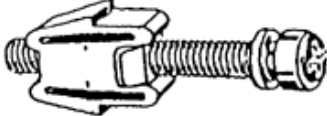
## ZINC PLATED SCREWS

J&B #	DESCRIPTION	QTY	
12906	1/4-20 x 5/8 Slotted Pan Head	100	
10360	#8	25	
10768	#10 x 5/8 Slotted Truss Washer Head	100	
10474	#14 x 5/8 Slotted Truss Head with Dog Point	50	
11120	6mm - 1.00 x 20mm Phillips Pan Machine Screw	100	
40909	#14 x 5/8 Slotted Hex Washer Head	50	
40913	6 – 1.81 x 20mm Phil Hex wash hd 12mm Wshr Hd. O.D. 10mm Hex Zinc Plt.	50	
40916	#14 x 3/4 Sl. Hex Wash Hd. 1/2 wash hd O.D. 3/8 Hex Black E-Coat	50	
59130	M6-1.0 x 20mm Sl. Hex Wash Hd. 13mm (1/2") Wshr Hd. O.D. 10mm Hex	50	
59132	#10 x 3/4" Phil Flt Wash Hd. 15/32 Wash Hd. O.D. Black E-Coat	100	







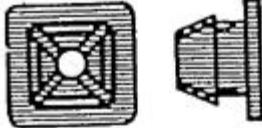

# HEADLIGHT ASSEMBLIES

J&B #	SIZE	TYPE	QTY	
11888	12-28 x 1-3/8	Screw & Nut	5	
11660	12-28 x 1-1/2	Screw & Nut	10	
13461	1/4-28 x 2	Screw & Nut	10	
13462		Nut	25	
11656		Nut	20	
10498	1/4-28 x 1-1/2	Screw	25	
10590	#8 Screw size 5/16 hole GM 1967-On	Nylon bezel nut	50	











# NYLON NUTS









(Illustrations Actual Size)

J&B #	SIZE	DESCRIPTION	QTY	
10583 (AVE3682)	1/4" Screw	GM License Plate	50	
10360 (AVE2625)	# 8 Screw	CHRYSLER Headlamp Door & Rear License Plate	25	
11927 (AVE10330)	# 8 Screw	GM Front End & Panel	25	
11842 (AVE9862)	# 8 - #10 Screw 1/4 Hole	FORD Universal Use	25	
12038 (AVE11697)	# 6 or # 8 Screw	AMC	25	
11702 (AVE9342)		GM Door Trim Pad	25	
25119 (AVE10727)		CHEVROLET Headlamp Bezel	25	
11670 (AVE9069)		BUICK Grill Nut	25	
11742 (AVE8578)	#10 Screw 5/16 Hole		25	







# TRIM CLIPS

J&B #	SIZE	DESCRIPTION	QTY	
45896 (AVE19118)	8mm	Push type Retainer Front Fender Civic & Del Sol 93' - On	15	
45900 (AVE19239)	8mm	Front Fender Push- Type Retainer Acura 3.5RL, Honda Accord, Prelude & Odyssey 94' - On	25	
45898 (AVE19233)	10mm	Front Bumper Push- type Retainer 3.5RL Sedan 96' - On	15	
45880 (AVE18114)	6mm	Hood Insulation Retaining Clip Honda & Accura 90' - On	25	
45890 (AVE18873)	9mm	Rear Bumper Cover Push-type Retainer Tercel 88' - On	4	
45894 (AVE19114)	6mm	Hood & Trunk Moulding Retaining Clip Acura Integra & Honda Civic 94' - On	10	
45892 (AVE18877)	6mm	Weatherstrip Retainer Acura 3.5 RL & Honda Accord, Civic & Odyssey 92' - On	25	
41937 (AVE22039)	8mm	Nissan/Infiniti Push- Type Retainer Black Nylon 2002-On	15	
59119 (AVE23501)	8mm	Hyundai, Accent, Azera, Elantra, Sonata, Tucson, Kia Amanti, Borrego, Cadenza, Forte, Rio, Rondo, Sedona, Soul	50	

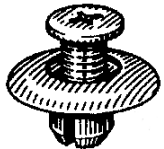
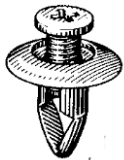

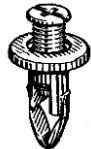
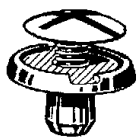

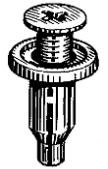

# TRIM CLIPS

J&B #	SIZE	DESCRIPTION	QTY	
40911 (AVE14267)	6mm	Screw grommet Lexus & Toyota Fits into 8mm hole	25	
40927 (AVE20247)	9mm	Bumper push-type Retainer Honda & Mitsubishi 98-On.	15	
40928 (AVE20348)	8mm	Push-type Retainer Maxima 94-On	15	
40929 (AVE20440)	9mm	Hood & Fender Screw grommet Camry & RAV 4 Fits into 9mm hole	15	
40931 (AVE20564)	10mm	Front & Rear bumper retainer Honda Accord & Odyssey 96-on	15	
59140 (AVE20755)	10mm	Bumper Cover & grille retainer 19.5mm Head Mazda 99-on	10	
59141 (AVE20869)	7mm	Front Fender Liner 18mm Head Celica, Corolla, Matrix & Solara, Lexus & Pontiac Vibe 99-on	10	
59142 (AVE20986)	10mm	Front Bumper Retainer w/ metal insert 20mm Head Civic 2006-on	10	

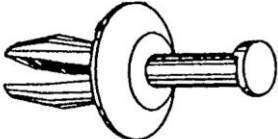

# TRIM CLIPS

J&B #	SIZE	DESCRIPTION	QTY	
45850 (AVE16000)	8mm	Push type Retainer	25	
45856 (AVE16858)	8mm	Inner Fender Retainer Nissan 80' - On	25	
45902 (AVE19246)	10mm	Bumper Push-type Retainer 240SX & Maxima 94-On	15	
45862 (AVE17143)	10mm	Push -type Retainer Accord 90' - On Bumper Fascia	10	
45870 (AVE17379)	8mm	Fender Splash Sheild Push-type Retainer Accord 90' - On	10	
45872 (AVE17632)	8mm	Push-type Retainer Mazda & Ford Aspire	10	
45882 (AVE18119)	10mm	Front & Rear Bumper Push-type Retainer Honda 90' - On	10	
59138 (AVE17347)	8mm	Front & Rear Bumper Cover Retainer Maxima & Infiniti 90' - On	15	
40397 (AVE19274)	8mm	Push-type Retainer Maxima & 300ZX 94' - On	15	





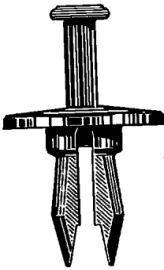

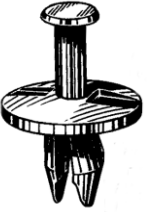
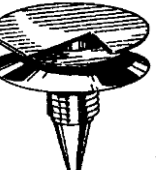
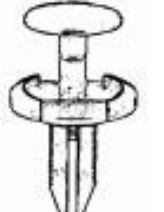
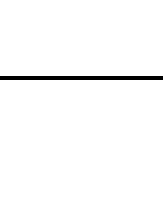

# TRIM CLIPS

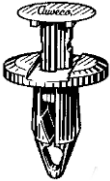
J&B #	DESCRIPTION	MAKE & YEAR	QTY	
11270 (AVE11130)	Hood Retainer	GM '64 - On	25	
40090 (AVE12567)	Front Fender Mud Skirt	GM '81 - On	25	
11387 41840 (AVE15414)	Radiator Yoke, Fender & Bumper Shield	GM, FORD, CHRYSLER	25 100	
11581 13397 (AVE10831)	Black Shield Retainer	GM, FORD, CHRYSLER, AMC	25 50	
13406 (AVE10832)	Gray Shield Retainer	GM '73 - On	25	
11989 (AVE10621)	Door Trim Panel & Headliner	GM '71 - On	25	
45876 (AVE17664)	Shield Retainer	GM '89 - On	50	





# TRIM CLIPS

J&B #	DESCRIPTION	MAKE & YEAR	QTY	
42066 (AVE12757)	Fascia Retainer	GM '79 - On	15	
42068 (AVE12766)	Front End Stone Retainer	GM '81 - On	25	
45810 (AVE12137)	Radiator Apron Panel Retainer	GM '77 - On	25	
42100 (AVE14753)	Nylon Radiator Shroud Retainer	GM '82 - On Ford '86 - On	25	
45430 (AVE14010)	Fascia Retainer	GM '82 - On	25	
45436 (AVE11796)	Door Trim Panel Retainer	GM '78 - On	50	
40917 (AVE19639)	Radiator, Wheel-House, Fender, & front bumper cover	GM C & K Trucks 99 - On Jeep Liberty 02 - On	25	

# TRIM CLIPS

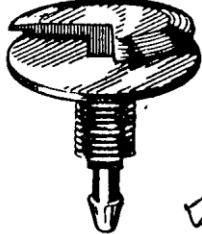

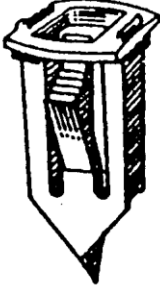
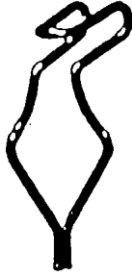
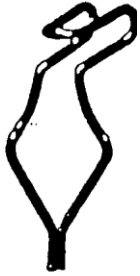

J&B #	DESCRIPTION	MAKE & YEAR	QTY	
45864 (AVE17216)	Air Baffle to Under Carriage Push-type Retainer	GM '91 - On	25	
45866 (AVE17222)	Push-type Retainer 8mm hole	GM '91 - On	25	
45878 (AVE18030)	Push-type Retainer 1/4 hole	GM '92 - On Dodge '93 - On	25	
45794 (AVE17612)	Trim Panel Trunk Lid Latch	1993 - On Ford Explorer 1996 - On Chrysler	50	
45796 (AVE12571)	Fascia to Bumper Retainer	Ford 81 - On	25	
45798 (AVE20362)	Trunk Trim Retainer	GM	25	
59143 (AVE20880)	Air inlet grille, bumper fascia & front brake caliper cooling duct 6.5 Hole	Buick enclave, Cadillac CTS & STS, Chevy cobalt, Equinox & SSR GM trucks & Pontiac G5 & torrent 2002-on	50	
59144 (AVE20889)	Cowl vent & fender push-type retainer 8.5mm Hole	Buick century, LaCrosse & Regal, Cadillac, chevy equinox, GM trucks, Hummer H3 & pontiac grand prix & torrent 97-on Ford 2006-on	25	

# TRIM CLIPS

J&B #	DESCRIPTION	MAKE & YEAR	QTY	
11946 (AVE11672)	Trim Panel	FORD '76 - On	25	
10396 (AVE8853)	Door Weatherstrip	FORD	25	
11310 (AVE11136)	Hood Insulation	FORD, CHRYSLER '73 - On	25	
11408 (AVE11118)	Headliner Clip	GM '73 - On	8	
12669 (AVE8206)	Door Trim Panel Fastener	FORD	25	
11056 (AVE10780)	Door Trim Panel Fastener	FORD	25	
45868 (AVE17339)	Weatherstrip Retainer	LINCOLN 89' - On	50	



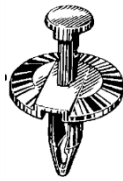
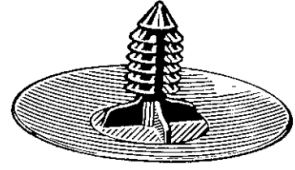
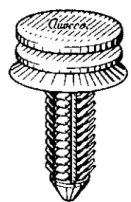



# TRIM CLIPS

J&B #	DESCRIPTION	MAKE & YEAR	QTY	
45818 (AVE12565)	Door Trim Panel Retainer	FORD '81 - On	25	
45822 (AVE12909)	Trim Panel Retainer Black Nylon	FORD 80' - On		
45838 (AVE14020)	Splash Shield & Facia Retainer	GM, Ford	25	
45843 (AVE15456)	Hood Insulation Retainer	GM 80' On	25	
45854 (AVE16695)	Front Door Trim Panel Retainer	GM 82' On	25	
45906 (AVE16695)	Push type Retainer	INTREPID & EAGLE 98' On	25	
45826 (AVE12992)	Door Trim Panel Retainer	GM '83 - On	25	

# MOULDING FASTENERS

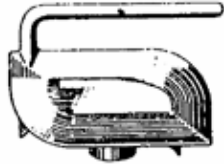
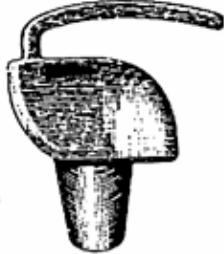
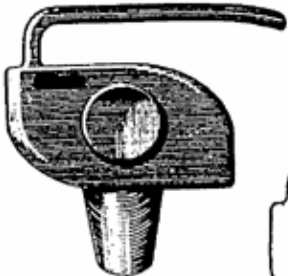
## NYLON

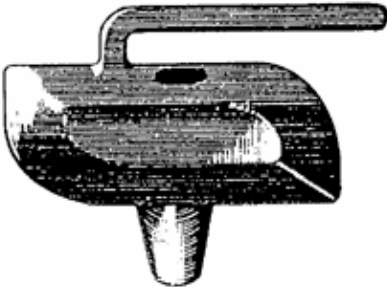

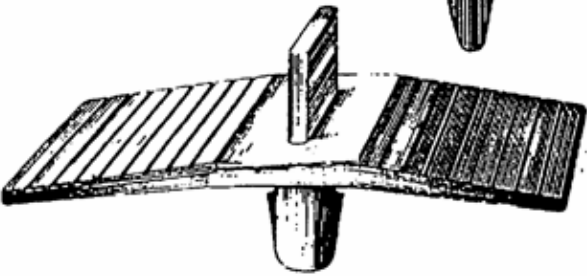
(Illustrations Actual Size)

J&B #	DESCRIPTION	QTY	
10315	Front & Rear Door Mould	25	
10316	Front & Rear Door & Quarter Panel Mould	25	
10317	Rear Fender Lower Mould	20	
10318	Rear Fender Lower Mould	15	
10319	For 1-1/4 to 1-3/4 Mould	12	
11952	Fits 1/2 to 5/8 Moulding	25	
10320	Mould Fast Break off Plate	10	

# MOULDING FASTENERS

## METAL

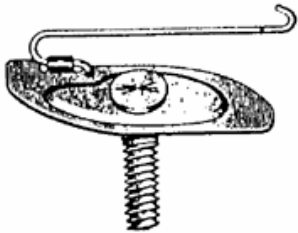

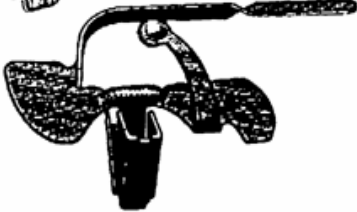



(Illustrations Actual Size)

J&B #	DESCRIPTION	QTY	
10303	10-24 x 5/8 Bolt	25	
10307	10-24 x 3/4 Bolt	25	
10365	General Purpose	15	
11638		10	

# MOULDING FASTENERS

## REVEAL CLIPS

(Illustrations Actual Size)

J&B #	DESCRIPTION	MAKE & YEAR	QTY	
11809	Rear Window	GM '65 - On	25	
12087	Windshield - Upper & Lower	GM '67 - On	25	
12058	Rear Window	GM '69 - On	25	
11811	Rear Window	GM '69 - On	25	
10696	Windshield & Rear Window	Ford '68 - On	25	
13662	Belt Reveal Moulding	GM '76 - On	25	

## ROCKER PANEL

J&B #	MAKE & YEAR	QTY	
11968	GM '80 - On	25	

# BODY SHOP

## THROTTLE CLIPS



LEFT HAND TYPE			
J&B #	DIA.	IND. STD.	QTY
10937	5/32	# 2L	25
10939	3/16	# 4L	25

RIGHT HAND TYPE			
J&B #	DIA.	IND. STD.	QTY
10938	5/32	# 2R	25

## REMOTE CONTROL ROD TO DOOR LOCK CLIP

J&B #	QTY
40125	50



**ADJUSTING**

## SPRINGS

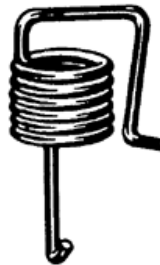

J&B #	DESCRIPTION	QTY
10577	OLDS	10

## HOG RING (Medium)



J&B #	QTY
10923	100



# BODY SHOP

---

## ROUTING CLIPS



J&B #	ID	OD.	QTY
45840	1/2	11/16	25

## RADIATOR GRILLE RETAINER



- GM Pickup, Van, Blazer, Jimmy 94- On

J&B #	QTY
45886	25

---

## HEADLIGHT COMPONENT RETAINING CLIP

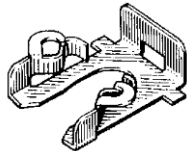

- Ford Taurus, T-Bird, Mercury Cougar & Sable 89'- On

J&B #	QTY
45848	25

## RADIATOR GRILLE NUT



- #8 Grille Nut #8 Screw Size GM Trucks C & K, 1, 2 & 3 1993-On

J&B #	QTY
59139	25

# PLUGS

## DRAIN PLUGS W/GASKET



1/2-20 DOUBLE OVERSIZE	
J&B#	QTY
20021	10



1/2-20 OVERSIZE	
J&B #	QTY
20022	10



1/2-20 STANDARD	
J&B #	QTY
20023	10

## DRAIN PLUG

- 3/8" drive with green o-ring. **One-time use.**
- **Precision fit & leak-free performance:** Engineered & manufactured to exacting standards.
- **Strong, heat resistant & oil resistant:** Made of the same glass fiber PA66 material as the OEM design.
- **Continuous seal:** This FKM (fluorinated, carbon-based synthetic rubber) O-ring can withstand higher temperatures compared to other manufacturers & the original 1<sup>st</sup> generation OEM design.
- **Twist & Lock:** Retains the original OEM 3/8" socket drive tightening feature Versus the weaker finger-tight style on later generation drain plugs.



J&B #	QTY
41362	EA

## PLUG BUTTONS

J&B #	HOLE SIZE	HEAD DIA	QTY
11161	1/4	13/32	50
11162	3/8	1/2	50
11163	1/2	21/32	25
11164	5/8	13/16	25
11165	3/4	15/16	20
11166	7/8	1-1/16	20
11167	1	1-1/8	10



- Nickel Plated

# INSULATED TUBING CLAMPS

## STANDARD TYPE Zinc Plated

- 1/32" thick black vinyl plastic coating.
- Resists abrasions and chemical action.



J&B #	D	H	L	W	G	S	QTY
	INSIDE DIA.	HOLE DIA.	CENTER TO CENTER	WIDTH	GAUGE	SLOT LENGTH	
13357	1/4	9/32	17/32	1/2	.032	3/8	25
13358	5/16	9/32	9/16	1/2	.032	3/8	25
13359	3/8	9/32	19/32	1/2	.032	3/8	25
13360	1/2	9/32	21/32	1/2	.048	3/8	25
13361	5/8	9/32	23/32	1/2	.048	3/8	15
13362	3/4	9/32	25/32	1/2	.048	3/8	10

## EXTRA HEAVY DUTY TYPE Zinc Plated

J&B #	D	H	L	W	G	S	QTY
	INSIDE DIA.	HOLE DIA.	CENTER TO CENTER	WIDTH	GAUGE	SLOT LENGTH	
38720	1/4	13/32	21/32	3/4	.032	1/2	25
38722	5/16	13/32	11/16	3/4	.032	1/2	25
38724	3/8	13/32	23/32	3/4	.032	1/2	25
38726	1/2	13/32	25/32	3/4	.048	1/2	25
38728	5/8	13/32	27/32	3/4	.048	1/2	25
38730	3/4	13/32	29/32	3/4	.048	1/2	25
13363	1	13/32	1-1/32	3/4	.048	1/2	10
13364	1-1/4	13/32	1-5/32	3/4	.048	1/2	10
38732	1-1/2	13/32	1-9/32	3/4	.048	1/2	10
38733	1-3/4	17/32	1-17/32	1	.048	5/8	10
38734	2	9/16	2	1	.048	5/8	10

## NYLON TYPE

J&B#	WIDTH	TUBE DIA.	QTY
10436	3/8	1/4	20
10437	3/8	5/16	20
10438	3/8	3/8	20
10439	3/8	1/2	20
10445	3/8	5/8	20



- Secure cable, tubing, wires, fiber optics, etc. with these high quality nylon cable clamps.



# CLAMPS

## LOOM CLAMPS Carbon Steel Plated

- Carbon steel loom clamps have a higher ductility and are susceptible to less fatigue than other metal loom clamps.
- Ideal for applications that are constantly in high vibration and harsh environments.
- Plated with zinc/gold chromate; Removable EPDM jacket.



J&B #	INSIDE DIA.	MOUNTING HOLE DIA.	WIDTH	BOLT SIZE	QTY
45240	1/4	13/32	5/8	3/8	10
45241	3/8	13/32	5/8	3/8	10
45242	1/2	13/32	5/8	3/8	10
45243	5/8	13/32	5/8	3/8	10
45244	3/4	13/32	5/8	3/8	10
45246	1"	13/32	5/8	3/8	10
45248	1-1/4	13/32	5/8	3/8	10
45250	1-1/2	13/32	5/8	3/8	10
45251	2"	13/32	5/8	3/8	10
45460	2-1/2	13/32	5/8	3/8	10

## LOOM CLAMPS Stainless Steel

- Stainless steel loom clamps have a removable EPDM cushion which helps cut vibration while protecting the loom or cables.
- Typical applications include holding hydraulic hoses, wire harnesses and cables.



J&B #	INSIDE DIA.	MOUNTING HOLE DIA.	WIDTH	BOLT SIZE	QTY
45225	1/4	17/64	1/2	1/4	10
45226	3/8	17/64	1/2	1/4	10
45227	1/2	17/64	1/2	1/4	10
45228	5/8	17/64	1/2	1/4	10
45229	3/4	17/64	1/2	1/4	10
45230	1"	17/64	1/2	1/4	10
45232	1-1/4	17/64	1/2	1/4	10
45234	1-1/2	17/64	1/2	1/4	10

# CLAMPS

## WIRE LOOM CLAMPS

J&B #	CLAMPING DIA	QTY
86160	3/16	25
86161	1/4	25
86162	3/8	25



## INSULATED HALF CLAMPS Galvanized

- 1/32" thick black vinyl plastic coating.
- Resists abrasions and chemical action.



J&B #	INSIDE DIA.	HOLE DIA.	CENTER TO CENTER	WIDTH	GAUGE	TOP OF RADIUS TO BASE	QTY
76020	3/16	7/32	7/16	1/2	.032	5/32	25
76021	1/4	7/32	1/2	1/2	.048	7/32	25
76022	5/16	9/32	17/32	5/8	.048	9/16	25
76023	3/8	9/32	9/16	5/8	.048	11/32	25
76024	1/2	9/32	11/16	5/8	.060	15/32	25
76025	5/8	9/32	13/16	5/8	.060	9/16	25
76026	3/4	9/32	7/8	5/8	.060	11/16	25

# SHIMS

## BODY ALIGNING SHIMS

J&B #	DIMENSION S	SLOT	THICK- NESS	QTY
10469	1-1/4 x 1-1/8	3/8	1/16	50
10470	1-1/4 x 1-1/8	3/8	1/8	50

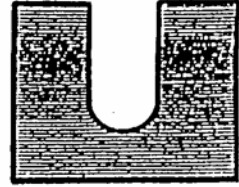

J&B #	DIMENSION S	SLOT	THICK- NESS	QTY
10471	1-3/4 x 1-1/4	1/2	1/16	50
10472	1-3/4 x 1-1/4	1/2	1/8	50

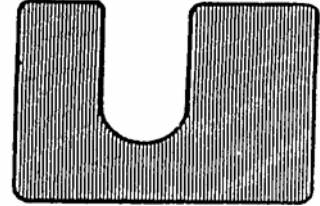

J&B #	DIMENSION S	SLOT	THICK- NESS	QTY
20101	1-1/8 x 1-1/8	1/2	1/16	50
20102	1-1/8 x 1-1/8	1/2	1/8	50

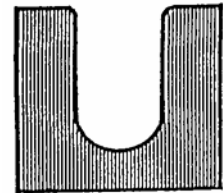

# SHIMS

## UNIVERSAL ALIGNMENT SHIMS

J&B #	DIMENSIONS	SLOT	THICK- NESS	QTY
40625	1-3/16 x 1-15/32	5/8	1/64	25
40626	1-3/16 x 1-15/32	5/8	1/32	25
40627	1-3/16 x 1-15/32	5/8	1/16	25
40628	1-3/16 x 1-15/32	5/8	1/8	25

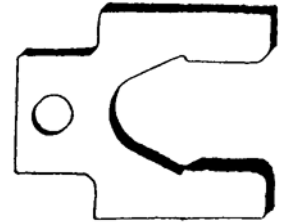

## CASTERS & CHAMBER SHIMS GM

J&B #	DIMENSION S	BOLT OPENING	THICK- NESS	QTY
20204	1 x 1-11/16	37/64	1/32	50

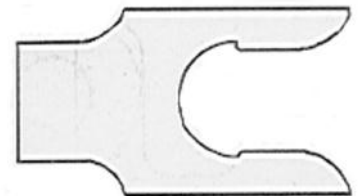

# UNIVERSAL SPRINGS

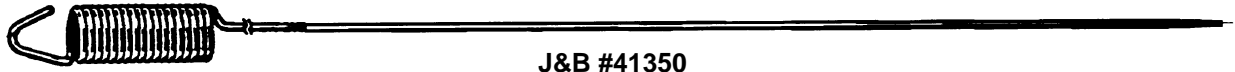

J&B #41350



J&B #41351

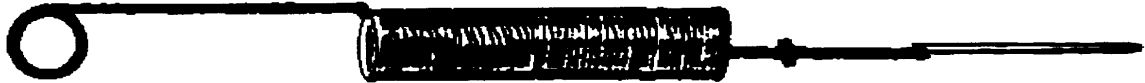

J&B #41353

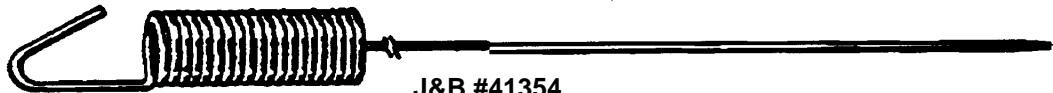

J&B #41354



J&B #41356



J&B #41360

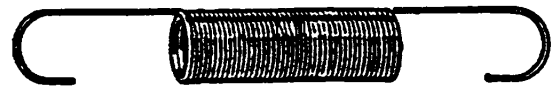

J&B #41357

J&B #	LENGTH OVERALL	COIL LENGTH	O.D.	WIRE SIZE	QTY
41350	18-1/2	2	13/16	3/32	10
41351	17-1/2	3-1/2	3/4	1/16	10
41353	11-1/2	1-7/8	13/32	1/32	10
41354	8-1/2	1-7/8	3/4	3/32	10
41356	8-1/4	2	7/16	1/16	10
41357	5-3/4	2-3/8	25/32	3/64	10
41360	4-3/8	2-1/2	1/2	1/16	10

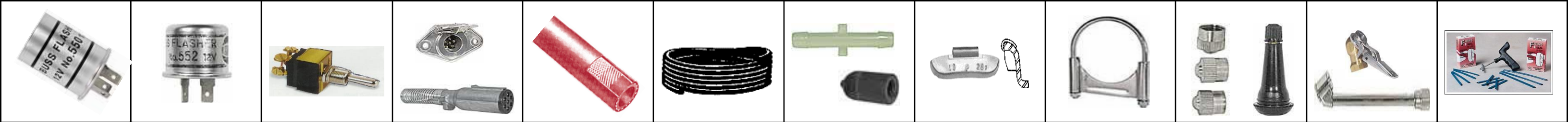

# J&B Fleet - Industrial Supply

www.jbfleet.com

22428 Harrisburg-Westville Rd. Alliance, Ohio 44601 Phone: (330) 821-6342 Fax: (330) 821-0411

## METRIC BODY BOLTS & NUTS

### PART # 2237

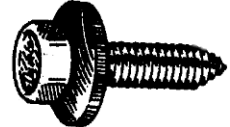
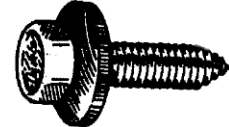
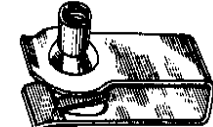
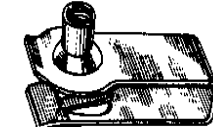
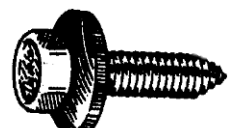
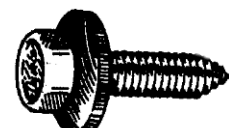
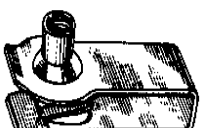
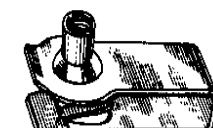
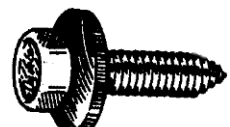
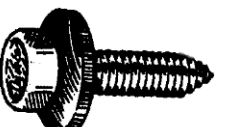
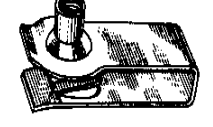
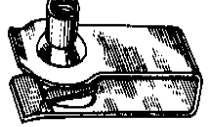
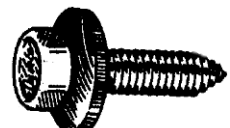
<p>10</p> <p><b>45410</b></p>  <p><b>M6-1.00 x 20 WASHER OD 17MM</b></p>	<p>5</p> <p><b>42008</b></p>  <p><b>M8-1.25 x 25 WASHER OD 24MM</b></p>	<p>10</p> <p><b>42094</b></p>  <p><b>6-1.0MM CLEARANCE 13.5MM RANGE .8 - 4.0MM</b></p>	<p>5</p> <p><b>42000</b></p>  <p><b>8-1.25MM CLEARANCE 14.5MM RANGE .8 - 4.0MM</b></p>
<p>10</p> <p><b>41841</b></p>  <p><b>M6-1.00 x 25 WASHER OD 17MM</b></p>	<p>5</p> <p><b>41882</b></p>  <p><b>M8-1.25 x 30 WASHER OD 24MM</b></p>	<p>10</p> <p><b>41878</b></p>  <p><b>6-1.0MM CLEARANCE 19.5MM RANGE .34 - 4.0MM</b></p>	<p>5</p> <p><b>41874</b></p>  <p><b>8-1.25MM CLEARANCE 20.0MM RANGE .8 - 4.5MM</b></p>
<p>10</p> <p><b>45418</b></p>  <p><b>M6-1.00 x 25 WASHER OD 24MM</b></p>	<p>5</p> <p><b>45802</b></p>  <p><b>M10-1.50 x 40 WASHER OD 29MM</b></p>	<p>10</p> <p><b>42102</b></p>  <p><b>6-1.0MM CLEARANCE 19.5MM RANGE 1.0 - 2.5MM</b></p>	<p>5</p> <p><b>42086</b></p>  <p><b>10-1.50MM CLEARANCE 19MM RANGE 1.0 - 6.0MM</b></p>
<p>10</p> <p><b>42004</b></p>  <p><b>M6-1.00 x 25 WASHER OD 24MM</b></p>			

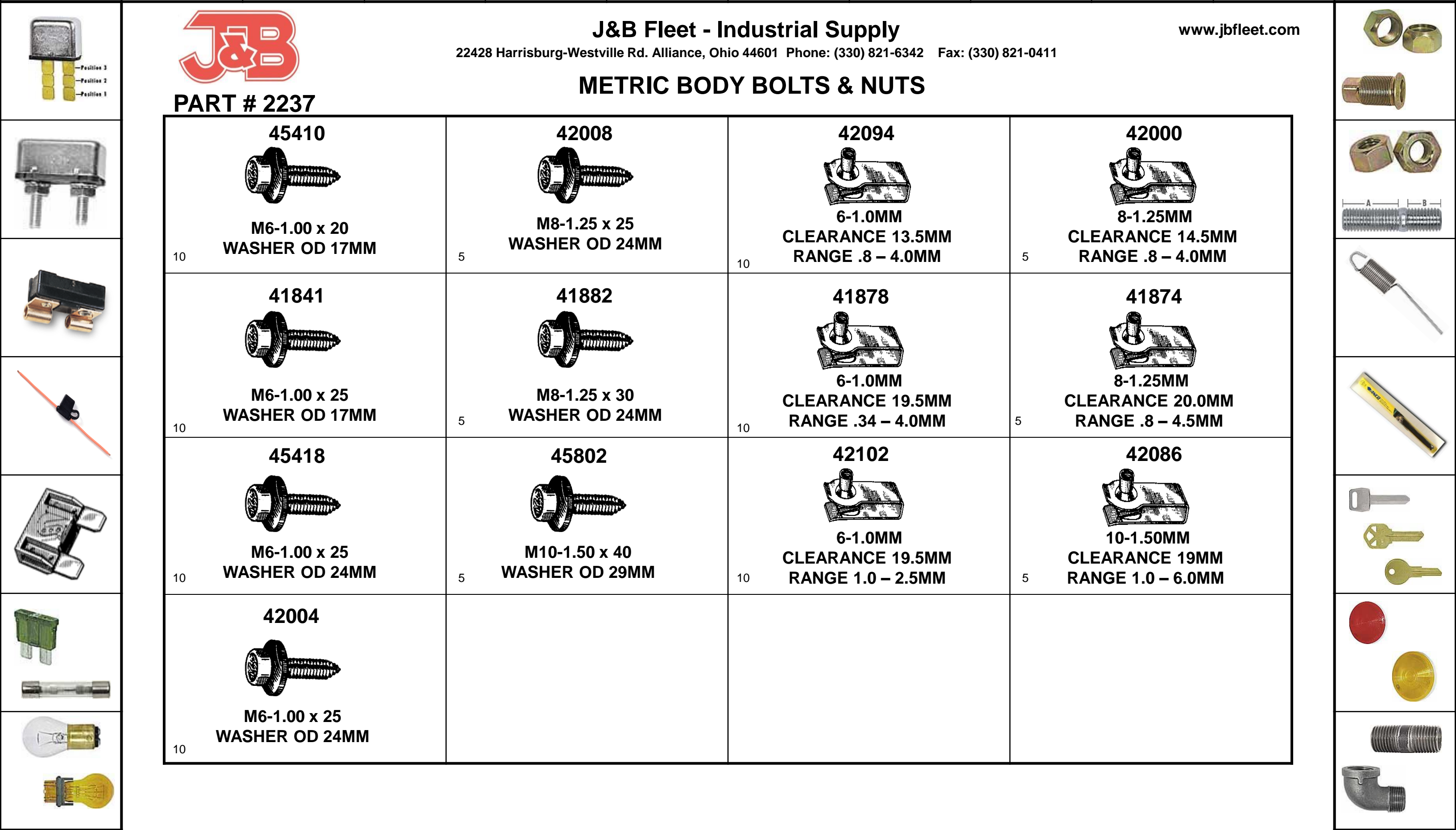































# J&B Fleet - Industrial Supply

www.jbfleet.com

22428 Harrisburg-Westville Rd. Alliance, Ohio 44601 Phone: (330) 821-6342 Fax: (330) 821-0411

## RETAINERS

PART # 2294

 <b>45838</b> 1 GM FORD PUSH PIN 10	 <b>59144</b> 2 GM FORD PUSH PIN 10	 <b>59142</b> 3 HONDA PUSH PIN 5	 <b>59143</b> 4 GM FORD PUSH PIN 10	 <b>45878</b> 5 GM CHRYSLER PUSH PIN 10	 <b>45850</b> 6 GM PUSH PIN 10	 <b>45866</b> 7 GM PUSH PIN 10	 <b>42100</b> 8 GM FORD PUSH PIN 10
 <b>45902</b> 9 NISSAN PUSH PIN 5	 <b>45862</b> 10 HONDA PUSH PIN 5	 <b>45870</b> 11 HONDA PUSH PIN 5	 <b>45872</b> 12 MAZDA FORD PUSH PIN 5	 <b>45882</b> 13 HONDA PUSH PIN 5	 <b>59138</b> 14 NISSAN PUSH PIN 5	 <b>45864</b> 15 GM FORD CHRYSLER PUSH PIN 10	 <b>45856</b> 16 NISSAN PUSH PIN 10
 <b>45896</b> 17 HONDA PUSH PIN 5	 <b>45900</b> 18 HONDA PUSH PIN 10	 <b>45898</b> 19 HONDA PUSH PIN 5	 <b>40927</b> 20 HONDA ACURA PUSH PIN 5	 <b>40928</b> 21 HONDA MITSUBISHI PUSH PIN 5	 <b>40931</b> 22 HONDA PUSH PIN 5	 <b>59140</b> 23 MAZDA PUSH PIN 5	 <b>59141</b> 24 TOYOTA LEXUS PONTIAC PUSH PIN 5
 <b>11581</b> 25 SHORT RETAINER 5/16 DIA 10	 <b>11387</b> 26 MEDIUM RETAINER 5/16 DIA 10	 <b>45876</b> 27 LONG RETAINER 5/16 DIA 10	 <b>45796</b> 28 LG HEAD RETAINER 5/16 DIA 10	 <b>45794</b> 29 MEDIUM RETAINER 3/8 DIA 10	 <b>42068</b> 30 LONG RETAINER 7/16 DIA 10	 <b>45798</b> 31 GM TRUCK BUMPER FACIA 10	 <b>45880</b> 32 HONDA ACURA RETAINER 10

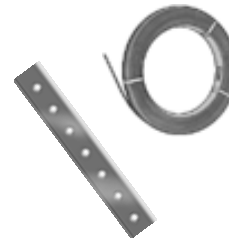

LET US HELP YOU MAKE THE CONNECTION

**PART# 3098**



**WELL NUTS**



J & B FLEET-INDUSTRIAL SUPPLY  
PHONE: 330-821-6342

<b>55892</b>	<b>55893</b>	<b>55894</b>	<b>55895</b>	<b>55896</b>	<b>40908</b>
<b>6 - 32</b>	<b>8 - 32</b>	<b>10 - 24</b>	<b>10 - 32</b>	<b>1/4 - 20</b>	<b>M6 - 1.0</b>
<b>1/4 HOLE</b>	<b>5/16 HOLE</b>	<b>3/8 HOLE</b>	<b>3/8 HOLE</b>	<b>1/2 HOLE</b>	<b>1/2 HOLE</b>
10	10	10	10	10	10



LET US HELP YOU MAKE THE CONNECTION

PART # 3041



# SELF-THREADING NUTS



J & B FLEET-INDUSTRIAL SUPPLY  
PHONE: 330-821-6342

<b>11534</b>  <b>1/8 STUD</b> <b>17/32 OD</b>  50	<b>12199</b>  <b>5/32 STUD</b> <b>9/16 OD</b>  50	<b>11535</b>  <b>3/16 STUD</b> <b>5/8 OD</b>  50		<b>11536</b>  <b>1/4 STUD</b> <b>7/16 OD</b>  50	
<b>12217</b>  <b>5/16 STUD</b> <b>7/8 OD</b>  25		<b>10623</b>  <b>10-24</b> <b>3/4 FLANGE</b>  50		<b>10634</b>  <b>1/4-20</b> <b>19/32 FLANGE</b>  50	

LET US HELP YOU MAKE THE CONNECTION



J&B FLEET-INDUSTRIAL SUPPLY  
PHONE: 330-821-6342

PART # 3103

## PUSH ON NUTS

**10370**



1/4"

50

**10371**



5/16"

50

**10372**



3/8"

50

**10373**



7/16"

25

**10374**



1/2"

25

**42064**



M8-1.25

25

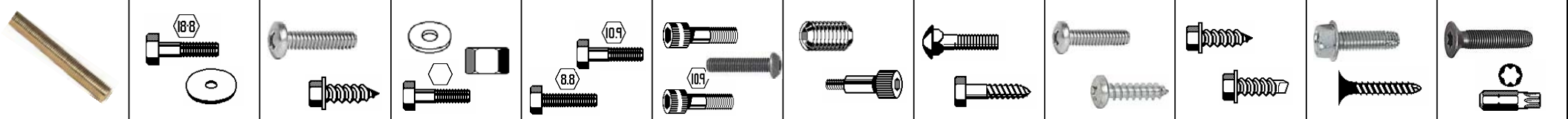























# J&B Fleet - Industrial Supply

22428 Harrisburg-Westville Rd. Alliance, Ohio 44601 Phone: (330) 821-6342 Fax: (330) 821-0411

[www.jbfleet.com](http://www.jbfleet.com)

PART # 2212

## RETAINERS

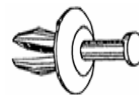
<p>11387 <sup>1</sup></p>  <p>RADIATOR YOKE</p> <p>15</p>	<p>11581 <sup>2</sup></p>  <p>BLACK SHIELD RETAINER</p> <p>15</p>	<p>11989 <sup>3</sup></p>  <p>DOOR TRIM PANEL &amp; HEADLINER</p> <p>15</p>	<p>45876 <sup>4</sup></p>  <p>SHIELD RETAINER</p> <p>15</p>	<p>42068 <sup>5</sup></p>  <p>FRONT END STONE RETAINER</p> <p>10</p>	<p>45810 <sup>6</sup></p>  <p>RADIATOR APRON PANEL RETAINER</p> <p>15</p>
<p>45436 <sup>7</sup></p>  <p>DOOR TRIM PANEL RETAINER</p> <p>15</p>	<p>45818 <sup>8</sup></p>  <p>DOOR TRIM PANEL RETAINER</p> <p>15</p>	<p>45826 <sup>9</sup></p>  <p>DOOR TRIM PANEL RETAINER</p> <p>15</p>	<p>45854 <sup>10</sup></p>  <p>FRONT DOOR TRIM PANEL RETAINER</p> <p>10</p>	<p>45822 <sup>11</sup></p>  <p>TRIM PANEL RETAINER BLACK NYLON</p> <p>15</p>	<p>45843 <sup>12</sup></p>  <p>HOOD INSULATION RETAINER</p> <p>10</p>
<p>45794 <sup>13</sup></p>  <p>TRIM PANEL RETAINER</p> <p>10</p>	<p>45796 <sup>14</sup></p>  <p>FASCIA TO BUMPER RETAINER</p> <p>10</p>	<p>45798 <sup>15</sup></p>  <p>BUMPER FASCIA RETAINER</p> <p>5</p>	<p>45880 <sup>16</sup></p>  <p>HOOD INSULATION RETAINING CLIP</p> <p>10</p>	<p>45838 <sup>17</sup></p>  <p>SPLASH SHIELD &amp; FASCIA RETAINER</p> <p>15</p>	<p>45878 <sup>18</sup></p>  <p>PUSH TYPE RETAINER 1/4 HOLE</p> <p>10</p>
<p>45866 <sup>19</sup></p>  <p>PUSH TYPE RETAINER 8MM HOLE</p> <p>10</p>	<p>45864 <sup>20</sup></p>  <p>AIR BAFFLE TO UNDERCARRIAGE PUSH-TYPE RETAINER</p> <p>10</p>	<p>45430 <sup>21</sup></p>  <p>FASCIA RETAINER</p> <p>10</p>	<p>42100 <sup>22</sup></p>  <p>NYLON RADIATOR SHROUD RETAINER</p> <p>15</p>	<p>40090 <sup>23</sup></p>  <p>FRONT FENDER MUD SKIRT</p> <p>15</p>	<p>24</p>

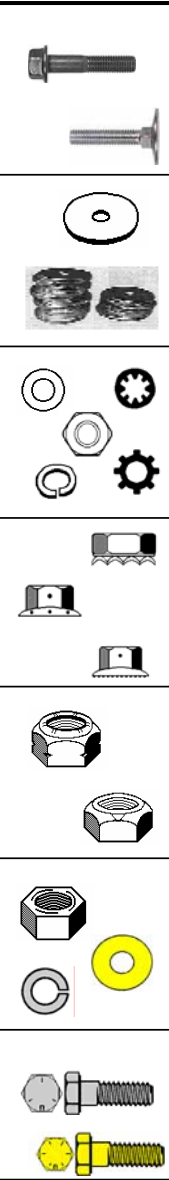



# J&B Fleet - Industrial Supply









22428 Harrisburg-Westville Rd. Alliance, Ohio 44601 Phone: (330) 821-6342 Fax: (330) 821-0411

[www.jbfleet.com](http://www.jbfleet.com)

PART # 2087

## HEAVY DUTY TUBE CLAMPS



<p>10</p> <p><b>38728</b></p>  <p>5/8 (13/32 HOLE)</p>	<p>1</p> <p>2</p>	<p>3</p>
<p>10</p> <p><b>38726</b></p>  <p>1/2 (13/32 HOLE)</p>	<p>4</p> <p><b>13363</b></p>  <p>1" (13/32 HOLE)</p>	<p>5</p> <p><b>38732</b></p>  <p>1-1/2 (13/32 HOLE)</p>
<p>10</p> <p><b>38724</b></p>  <p>3/8 (13/32 HOLE)</p>	<p>7</p> <p>8</p>	<p>9</p>
<p>10</p> <p><b>38722</b></p>  <p>5/16 (13/32 HOLE)</p>	<p>10</p> <p><b>38730</b></p>  <p>3/4 (13/32 HOLE)</p>	<p>11</p> <p><b>13364</b></p>  <p>1-1/4 (13/32 HOLE)</p>



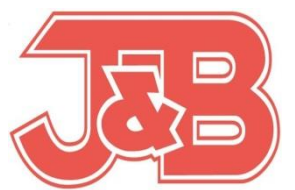
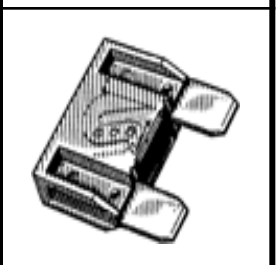
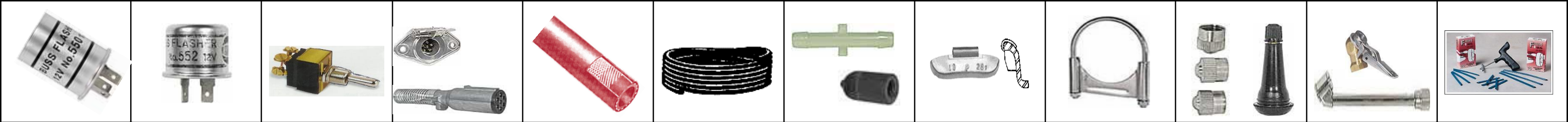







**PART#2827**

**J&B Fleet - Industrial Supply**

22428 Harrisburg-Westville Rd. Alliance, Ohio 44601 Phone: (330) 821-6342 Fax: (330) 821-0411

[www.jbfleet.com](http://www.jbfleet.com)

**LOOM CLAMPS - CARBON STEEL**

<p><b>45240</b></p>  <p><b>1/4"</b></p> <p>5</p>	<p><b>45243</b></p>  <p><b>5/8"</b></p> <p>4</p>	<p><b>45246</b></p>  <p><b>1"</b></p> <p>3</p>	<p><b>45250</b></p>  <p><b>1-1/2"</b></p> <p>2</p>
<p><b>45241</b></p>  <p><b>3/8"</b></p> <p>5</p>	<p><b>45244</b></p>  <p><b>3/4"</b></p> <p>4</p>	<p><b>45248</b></p>  <p><b>1-1/4"</b></p> <p>3</p>	







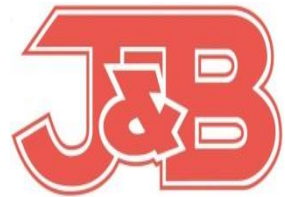

# J&B Fleet - Industrial Supply





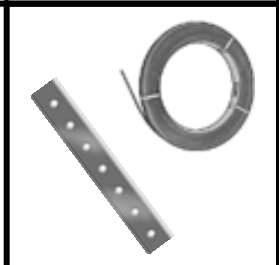

www.jbfleet.com

22428 Harrisburg-Westville Rd. Alliance, Ohio 44601 Phone: (330) 821-6342 Fax: (330) 821-0411

**PART # 2140**

## UNIVERSAL SPRINGS



5	<p><b>41350</b></p>  <p><b>18 1/2" LONG 13/16" O.D. 3/32" WIRE</b></p>	1
5	<p><b>41351</b></p>  <p><b>17 1/2" LONG 3/4" O.D. 1/16" WIRE</b></p>	2
5	<p><b>41353</b></p>  <p><b>11 1/2" LONG 13/32" O.D. 1/32" WIRE</b></p>	3
5	<p><b>41354</b></p>  <p><b>8 1/2" LONG 1 7/8" O.D. 3/32" WIRE</b></p>	4
5	<p><b>41356</b></p>  <p><b>8 1/4" LONG 7/16" O.D. 1/16" WIRE</b></p>	5
5	<p><b>41360</b></p>  <p><b>4 3/8" LONG 1/2" O.D 1/16" WIRE</b></p>	7
5	<p><b>41357</b></p>  <p><b>5 3/4" LONG 25/32" O.D. 3/64" WIRE</b></p>	8