



# Impedance Heating Systems



# Introduction

An Impedance Heating System is a unique, safe and proven method for electric pipeline tracing and heating. The pipe actually becomes the heating element when low AC voltage is applied to it by a special, custom designed transformer.

INDEECO can provide single source responsibility for design, hardware and start-up assistance for an impedance heating system to heat gasses or fluids flowing through your pipeline. It can also be used over a wide range of temperatures to prevent freezing in cold weather, maintain fluidity of viscous materials, raise the temperature of heat sensitive materials or maintain gas temperatures up to 1600° F.

The Hynes Electric Heating Company designed and fabricated electric heating equipment for demanding industrial applications since 1926. Based upon field experience with thousands of successful world-wide installations, Hynes was a recognized leader in electric process and pipeline heating applications for temperature sensitive liquids and gases.

In 1987, INDEECO purchased the Hynes Electric Heating Company. Together, INDEECO and Hynes represent many years of experience in electric process heating. We look forward to putting that experience to work for you in your next impedance heating application.

---

## Table of Contents

Benefits and Advantages . . . . .	1
How Impedance Heating Works . . . . .	2
Customers and Applications . . . . .	3
Impedance Heating Applications . . . . .	4-6
Engineering Application Guide . . . . .	7-9
The Impedance Heating System . . . . .	10-11
Application Data Sheet . . . . .	12
Limited Warranty	

---

# Benefits and Advantages

## Benefits of Impedance Heating

**Low Voltage Operation** — All systems operate at less than 30 Volts, many at 10 Volts or below. INDEECO systems meet or exceed the requirements of the National Electrical Code (Article 427), assuring safe operation.

**Uniform Heating** — Because the entire pipe effectively acts as the heating element, heat is generated uniformly throughout its entire length and circumference without hot spots.

**Simplicity** — The impedance method takes the complexity out of pipeline heating. A few basic components comprise the entire heating system. Installation is simple; it can be installed without disturbing most of the existing thermal insulation.

**Wide Temperature Range** — INDEECO has pioneered the use of impedance heating for applications ranging from below freezing to 1600° F. It is often the only viable option for high temperature pipeline heating.

**Close Control** — Thermocouple sensors placed along the pipeline provide precise, uniform temperature control. Optional SCR controls give the ability to achieve control within  $\pm 1^\circ$  F.

**Low Cost** — Installation costs are kept to a minimum by the inherent simplicity of the system. Likewise, maintenance is virtually eliminated; many systems operate unattended. Energy costs are low because the required energy is concentrated in the pipe and efficiently heats the fluid or gas traveling through it.

**No Burnouts** — When the pipe becomes the heating element, burnouts and failures associated with electrical resistance tapes and cables are eliminated.

## Advantages Over Conventional Methods

**No External Fluids** — Pipeline heating with steam or high temperature fluids introduces a high degree of complexity and a potential hazard. Impedance heating accomplishes the same result in a simple, straightforward manner.

**No Leaky Jackets** — With impedance heating, you won't have leaky steam lines, cracked steam traps, pump failures or frozen return pipes.

**No Hot Spots** — Impedance heating eliminates the danger of overheating temperature-sensitive materials (asphalt, chocolate, heavy syrups) because hot spots associated with conventional pipe tracing are eliminated.

**No Routine Maintenance** — Routine maintenance is eliminated, along with the replacement parts and production shutdowns associated with such maintenance.

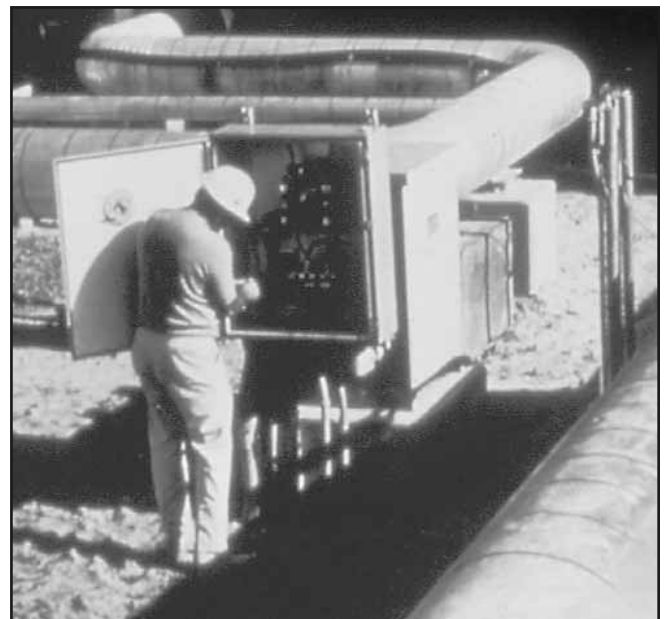

# How Impedance Heating Works

The basic concept of impedance heating is quite simple: Terminals are attached to each end of the pipe, and a low voltage current is passed through it. In other words, the pipe acts as its own heating element.

The explanation of how impedance heating works is a bit more complex. Traditionally, electric heat is generated by passing current through a wire that is purely resistive. This is how electrical resistance tape or cable tracing produces heat. With the impedance method, heat is generated by combining three different effects:

1. The pipe acts as a resistor, much the same as a wire in the traditional method. The electrical resistance of the pipe depends upon its length, composition and wall thickness.
2. When heating a straight length of pipe, it is necessary to attach a power cable to one end (see Figure 1). The cable is normally laid on the pipe's insulation jacket. The current flow in a typical impedance system is enough to set up a significant magnetic field around the cable. Since most pipes are made from magnetic materials, steel being the most common, the magnetic field interacts with the pipe, producing the second component of heat, skin effect/proximity effect.

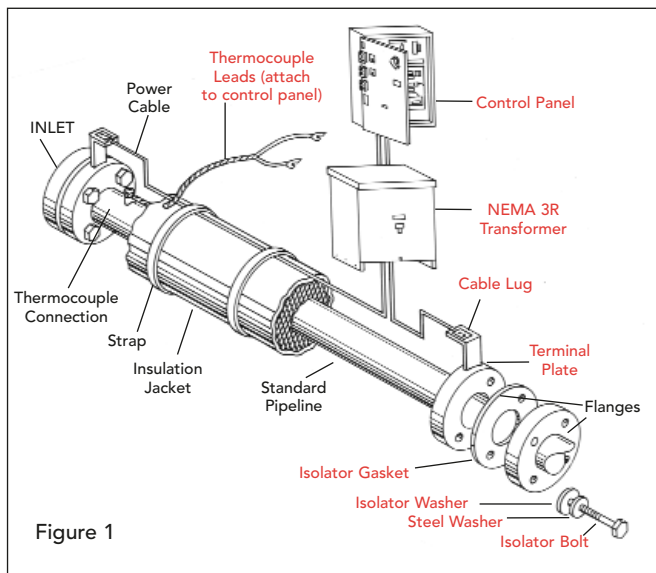

Figure 1

3. A 60 hertz power source produces a magnetic field that changes direction 60 times per second. The electrical inertia of the pipe relative to these changes produces a hysteresis effect, which is the third source of heat in the impedance method.

Taking all of these effects into account, INDEECO designs and furnishes a hardware package to generate the proper amount of heat for a given pipeline system. That package consists of the following:

- **Power Transformer** — A transformer, fed from a commercial power source, produces the correct voltage to give adequate heat and safe operating conditions. Furnished in its own enclosure, the transformer has multiple taps to fine-tune the voltage output in the field. Output voltages range from 1 to 30 Volts.
- **Control Panel** — Pipe temperature is controlled by a thermocouple sensor attached to the pipe. The standard control panel includes a process temperature controller, magnetic contactor and all necessary pilot lights, relays, fuses, etc. Optional solid-state proportional control, with fully modulated SCR, is also available for more precise temperature control.
- **Terminal Plates with Cable Lugs** — Terminal plates are supplied for field attachment to the pipe and low voltage power cabling.
- **Flange Isolation Kits** — In order to confine the electrical current to the section of pipe being heated, INDEECO can furnish isolation kits consisting of an isolator gasket for each end of the pipe and isolator bolts with proper washers to secure the gasket and mating flanges. Note that standard field-furnished flanges are used with the isolation kits. No special flange treatment is necessary.

# Customers and Applications

Impedance systems heat a wide variety of gases, liquids and viscous materials which are stored, pumped and processed in many different industries and applications. Impedance heating can be used in three basic ways:

**Cold Start:** Heat is applied to increase fluidity of static, viscous materials so they can be pumped. Typical materials include asphalt, molasses and heavy fuel oils.

**Maintain Temperature or Pipe Tracing:** Heat is applied to a liquid or gas flowing through a pipe to offset heat losses. Typical applications include freeze protection or maintaining the fluidity of viscous materials.

**Temperature Rise:** Heat is applied to a liquid or gas flowing through a pipe in order to raise its temperature between the inlet and outlet of the heated pipe. Typical applications include heating corrosive liquids or high temperature process air.

A partial list of customers and applications are shown below.

CUSTOMER	MATERIAL HEATED	TEMP (°F)	PIPE LENGTH (FT)
Allied Chemical Corp.	Coal Tar Pitch	450	131
Allied Fibers Corp.	Superheated Steam	1040	70
Aluminum Co. of America	Pitch	170	1155
American Hoechst Corp.	Polypropylene	400	22
Amoco Oil Co.	Fuel Oil	280	891
Amoco Oil Co.	Zinc Chloride	700	53
Arco Oil & Gas Co.	Crude Oil	150	15700
Atlantic Richfield	Salt Water	40	802
Barnard & Burk	Sulphur	265	70
Bethlehem Steel	#6 Fuel Oil	280	891
Boulogny Co.	Superheated Steam	845	34
British Petroleum Alaska	Water	40	611
Brown & Root Inc.	Crude Oil	50	1270
Catalytic Corp.	Liquid Pentasulfide	752	2
Celotex Corp.	Asphalt	400	1760
Certain Teed Corp.	Asphalt	480	52
Chemtex Inc.	Polymer	536	52
Chevrolet Motor Div.	Catalyst	70	770
Colgate Palmolive Inc.	Sulphur	300	165
E.I. Dupont	Process Gas	575	170
Emery Industries	Stearic Acid	160	370
Ethyl Corp.	Powdered Catalyst	450	53
Exxon Research & Engineering	Heavy Fuel Oil	950	552
Exxon Synthetics Inc.	Coal Slurry	370	558
Fisher Scientific Co.	Resin & Hardener Mix	194	40
Fortifiber Corp.	Asphalt	500	250
Foster Wheeler Corp.	Paraffin	60	1020
H.K. Ferguson	Pitch	735	100
Hershey Foods Corp.	Chocolate	110	377
Honeywell	Air	1200	114
Inland Steel Co.	Fuel Oil	160	8500
Intalco Aluminum	Air/Tar Mixture	500	52
International Paper	Wax	185	520
Kaiser Aluminum Co.	Coal Pitch	380	500
Kitchens of Sara Lee	Nulomoline	100	325
Koppers Co.	Enamel Filling	375	85
Layton Engineering	#6 Fuel Oil	125	550
M & M Mars Co.	Chocolate	120	1400
Medusa Cement Co.	#6 Fuel Oil	150	700
Mobil Pipe Line Inc.	Wax	145	93
Monsanto	Montar	752	230
N.L. Industries	Magnesium Chloride	1300	95
National Starch & Chemical	Wax	210	300
National Starch & Chemical	Wax/Resins	100	1400
Nestlé	Chocolate	110	263
Pillsbury Haagen Dazs	Sweeteners	120	180
PolyOne Elastomers & Performance Additives	Oil	180	350
Procon, LTD.	Sulphur	285	890
Rohm & Haas	Process Vapor	1100	26
Shell Chemical Co.	Process Fluid	500	41
Sherwin Williams, Inc.	Pitch	500	140
South Carolina Electric	Sulphur	110	1350
SPEC Process Engineering & Construction Inc.	Isocyanate	120	400
Stauffer Chemical Co.	Phosphorous Pentasulfide	707	30
Sun Oil Company	Sulphur	290	485
Tennessee Eastman	Polymers	320	1165
Trimount Bituminous	Asphalt	325	425
Union Electric Co.	Wax	212	612
Upjohn	Isocyanate	120	476
Vulcan Material	Caustic	750	360
Western Electric Co.	Thermoplastic Rubber	300	900
Yabucoa Sun Oil Co.	Pitch	400	2300

# Impedance Heating Applications

## Power Generating Utility

**Application:** To maintain heavy fuel oil at 140° F and facilitate pumping from barges to storage tanks and return lines. The application required cold start recovery capabilities to heat up the fuel oil in case of station shut down. Pipe size diameters ranged from 10" to 24" with a combined pipe length of almost two miles. Impedance heating was selected because critical importance was placed upon system reliability, maintenance and operating costs.

**Design:** Seven impedance heating systems were required. To conserve heat, pipe lines, gaskets and flanges were covered with 2" of insulation and sheathed with 16 gauge aluminum.



Impedance heating used to facilitate pumping of fuel oil from barges to storage tanks at power generating utility.

## Food Processing

**Application:** To maintain the temperature of chocolate and sweetener at 120° F as it flows through 16 gauge, sanitary 304 stainless steel tubing lines. Impedance heating was selected because of the temperature sensitive characteristics of the material and the importance of uniform temperature control to the quality of the product. Pipe lengths for different lines varied from 128 feet to 420 feet. The sanitary environment required frequent washdown of the control panel.

**Design:** Three individual impedance heating systems were required, rated 1.5, 2 and 3 KVA. Standard on-off control with operational RTD input was selected. Stainless steel, NEMA 4X control panel enclosures with a viewing window to monitor actual process variables were supplied to meet the frequent washdown requirements.

## Metal Processing

**Application:** To heat a mixture of air, water vapor and tar particles up to 400° F at a flow rate of 5,750 lbs/hr. Ten inch diameter stainless steel ducts were used in the first phase of the process where the mixture was heated up to 400° F. Carbon steel ducts were used in the second phase of the process to maintain the final temperature. Impedance heating was the most cost effective method for this application which included one additional requirement of heating the duct work up to 500° F during a cleaning phase where residual tar on the duct walls melt, allowing it to simply flow out of the duct work.

**Design:** Three individual impedance heating systems rated 36, 171 and 176 KVA were used in this application. Full SCR controls were used for each system to provide precise temperature control. Special weld terminals were also supplied due to the high secondary transformer currents.

## Plastic Processing

**Application:** To control, monitor and heat to temperature within 16 hours, a 4,800 foot, 2" schedule 40, 304L stainless steel pipe containing a sludge mixture. The impedance heating control panel needed computer interface with auxiliary outputs for alarm indication.

**Design:** Six identical 11 KVA impedance heating systems were supplied for this job. The solid-state proportional control panel was capable of remote signal input and temperature indication and included ammeters, voltmeter and auxiliary control circuit source. Under actual operating conditions, the impedance heating system exceeded the application requirements by providing a recovery time of only 14 hours, which was of critical importance to the process, allowing greater production rates.

# Impedance Heating Applications

## Chemical Processing

**Application:** A highly corrosive material must be heated through a 630° F temperature rise with a flow rate of 160 lbs/hr. Conventional process heating methods were too costly and could not withstand the high temperature corrosion for any reasonable period of time. Impedance heating provided the answer.

**Design:** Customer supplied, heavy wall, Inconel pipe became the heating element and transporting device in this impedance heating system. A mid-point connection system was selected to eliminate the need for electrical isolation at the pipe ends.

## Test Equipment

**Application:** To preheat high temperature air from 800° F to 1200° F at a flow rate of 20 lbs/min. Impedance heating was selected over the more conventional direct heating methods because of the low flow rate and high outlet temperature. A low pressure drop was also a requirement of the application. The impedance heating system easily met this requirement since the pipe became the heating element, offering no obstruction to the high temperature air flowing through the pipe.

**Design:** One 75 KVA impedance heating system was used. The design was a completely packaged unit including an Incoloy pipe in a multipass configuration, transformer, control panel with full instrumentation and high temperature insulation.



Packaged impedance heating system for test equipment application. (System cabinet enclosure was removed for photography.)

## Aerospace

**Application:** Constant 600° F air at pressures up to 3,000 psi was needed at three different locations, including two wind tunnels and one model preparation area. Distances from the air storage area to the point of use ranged from 100 ft. to 200 ft. Impedance heating was chosen as the most cost effective way of preheating the piping from the storage tank to the three use points.

**Design:** Initial heating of the air in the storage tank was performed by two 400 KW resistance heaters. Three individual 20 KVA impedance heating systems were then used to maintain the temperature of the air as it passed through the schedule 160 carbon steel piping which was selected because of its suitability for such high pressure applications. To minimize heating costs, all above ground piping was thermally insulated and some piping was buried underground with a fiberglass polyester weatherproof coating.



Impedance heating used to heat high temperature, high pressure air for aerospace application.

# Impedance Heating Applications

## Asphalt Processing

**Application:** To heat carry-off piping leading from the asphalt plant to storage tanks. Impedance heating was chosen as the most cost effective way to heat and maintain the temperature of 350 tons of asphalt at 100° F.

**Design:** A conventional impedance pipeline heating system was used for the carry-off piping. The transformer and control panel were located away from the storage area for easy access.

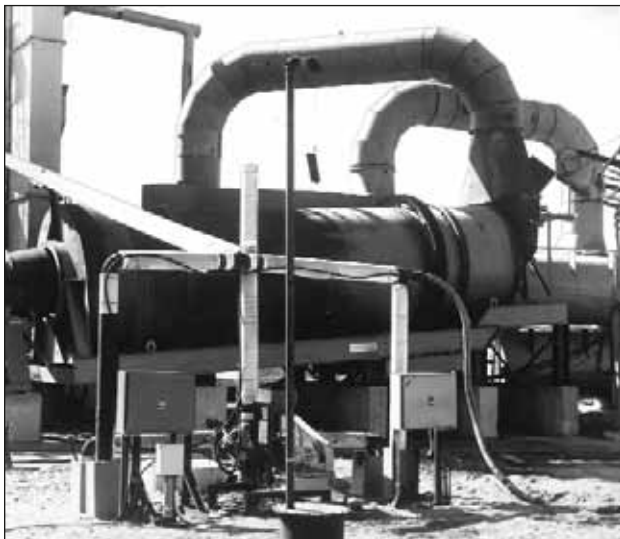

Impedance heating used to maintain temperature of 350 tons of asphalt.

## Aircraft Manufacturing

**Application:** To heat 1200 psig compressed air flowing at 75 lbs/hr from ambient to 1200° F for purposes of testing aircraft components. Several independent test cells required the equipment to be portable. An impedance heating furnace was chosen as the most cost effective and reliable means of heating air at these elevated temperatures and pressures.

**Design:** One 23 KVA, 480V single-phase impedance heating furnace was supplied with casters to allow for relocation of the furnace to the various test cells. The design was a completely packaged system with Incoloy 800 piping, mounted in an insulated stainless steel housing, and prewired to the system transformer and control panel.



Portable impedance heating furnace for testing aircraft components.

**Application:** To heat 1800 psig compressed air flowing at 240 to 600 lbs/hr from ambient to 1200° F for purposes of testing aircraft components. The customer's existing power feed required the utilization of three-phase power.

**Design:** A single 120 KVA, 480V three-phase impedance heating system was supplied with three identical zones to accept the three-phase power supply. The design was a completely packaged system with Incoloy 800 piping, mounted in an insulated stainless steel housing, and prewired to the system transformer. The control system was supplied for remote mounting in the customer's control room.



Three-phase impedance heating furnace for testing aircraft components.



## Electrical Pipe Connections and Designs

There are two basic types of impedance heating electrical connections. These are the end-point and mid-point connections. Simplified drawings illustrating these two connections for a pipe and cable design are shown in Figures 2 and 3.

### End-Point Connection

The end-point electrical connection is best suited for complex piping systems where multiple branches or “tees” are installed. There is no need to electrically balance the system, as with a mid-point connection, which makes installation much easier.

### Mid-Point Connection

Electrical isolation is not required at the pipe ends for this connection. Twice the length of pipe can be heated over an end-point system at the same secondary voltage, because the pipe is divided at the mid-point. This connection is best suited for straight or simple pipe runs where the electrical mid-point can be easily determined.

Figure 2 - Pipe and Cable Design with End-Point Electrical Connection

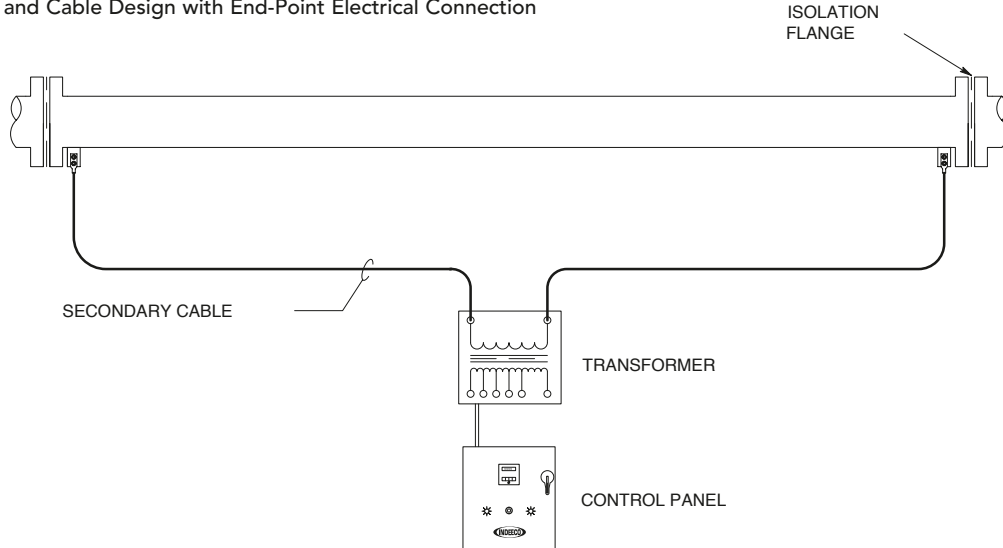
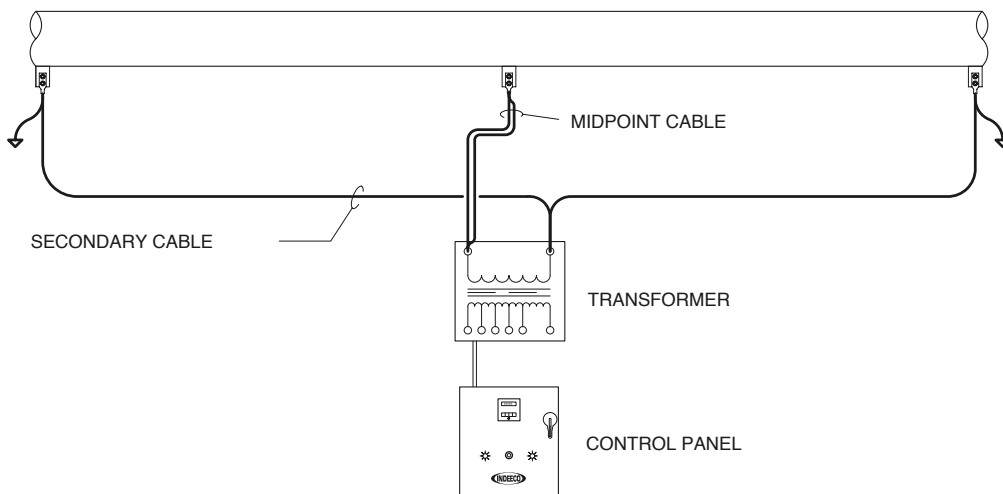

Figure 3 - Pipe and Cable Design with Mid-Point Electrical Connection



# Engineering Application Guide

## Piping Circuitry Drawings

A customer supplied isometric piping layout drawing will enable INDEECO to show recommended isolation points, electrical connections and cable runs.

The isometric drawing shown in Figure 4 represents a typical design for a piping arrangement with end-point connections. The overall length of the pipe in this system is 160 feet. The dotted lines represent return cables.

### LEGEND

—	PIPE
- - -	CABLE
≡	ISOLATION KIT (ELECTRICAL BREAK)
≡	FLANGE
☐	TERMINAL PLATE
○	THERMAL ELEMENTS

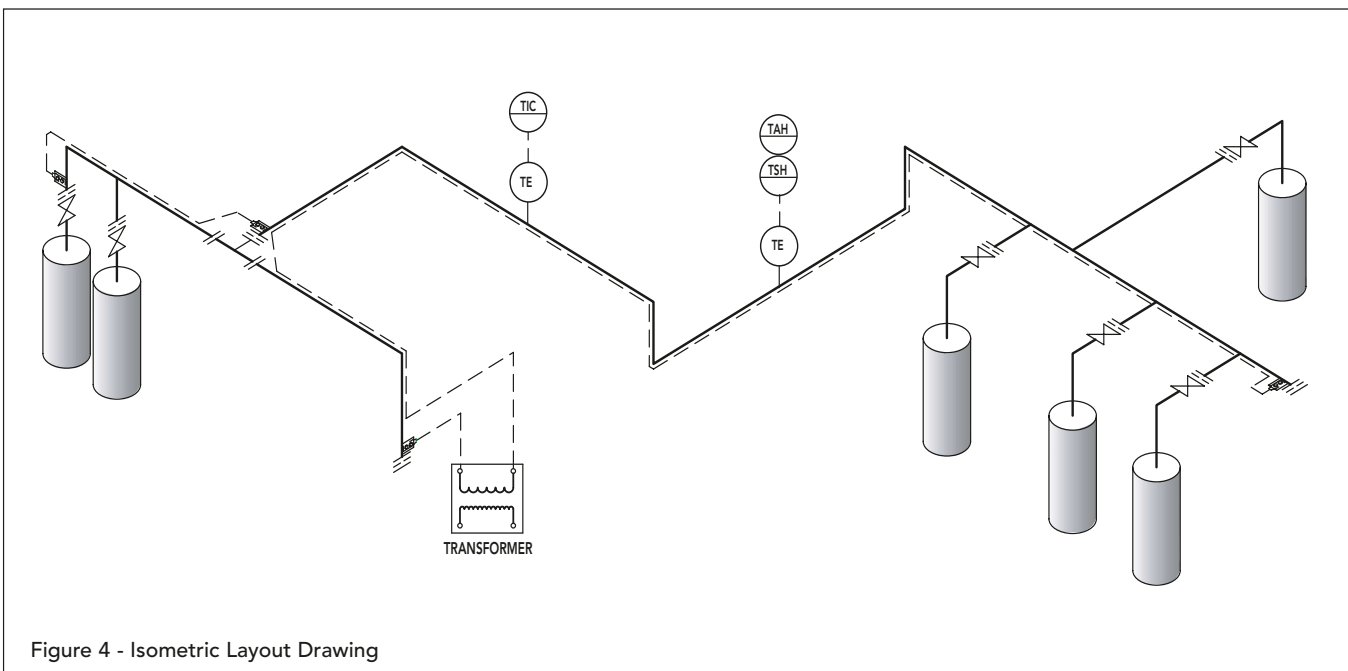

Figure 4 - Isometric Layout Drawing

# Engineering Application Guide

Impedance heating will maintain or raise the temperature of virtually any gas or liquid in either a flowing or static condition. Since the pipe is actually the heating element, maximum operating temperatures are only limited by the pipe's thermal characteristics.

Although the hardware for an impedance heating system is simple to understand and operate, over 25 interrelated application variables have to be considered during the initial design stage in order to select the appropriate system hardware. To effectively deal with the complex mathematics, INDEECO has developed an exclusive computer design program.

To design each system efficiently, our engineering department needs certain information. Using this information, the design output is generated by the computer program which is then used in the selection of the appropriate hardware.

## Customer Input Information

The following information is required for ALL PIPELINE HEATING applications:

**Pipe Size:** Pipe sizes range from 3/4" to 24" IPS and up to 36" for alloy materials. For carbon steel, we request the IPS pipe size and schedule number. For alloy pipe, we request outside diameter and wall thickness.

**Pipe Material:** Materials include carbon steel, stainless steel, nickel, Incoloy, Inconel, Monel, Hastelloy and Duranickel. Note: Copper, aluminum and other high electrically conductive materials cannot be used. Non-conductive materials, such as plastic pipe, are also unsuitable.

**Pipe Length:** This is virtually unlimited; however, short runs of a few feet are usually impractical, and long runs of over several hundred feet may require multiple systems. An accurate system pipe length is very important to the impedance design. Inaccurate measurements or estimated pipe lengths can result in a system that does not perform as designed.

**Insulation Type and Thickness:** The thermal insulation required on all heated pipes for energy efficiency varies in thickness and insulating properties. This information is needed to accurately determine heat loss and required KVA for the impedance heating system. Heat loss information can be provided by the customer or developed by INDEECO.

**Ambient Temperature:** The minimum and maximum ambient temperatures to which the pipeline will be exposed.

**Maintenance Temperature:** This is the temperature at which the pipe is to be maintained and is often the same temperature as the process material in the pipe.

The following information is required for COLD START or TEMPERATURE RISE applications:

**Specific Heat, Specific Gravity, Latent Heat of Fusion, and Melting Point:** This data is required for the static process material in the pipe at the time of cold start-up.

**Heatup Time:** This is the desired and/or available amount of time in hours to bring the process material in the pipe up to the maintenance temperature from ambient temperature.

**Inlet Temperature:** The fluid or gas temperature entering the pipe.

**Outlet Temperature:** The required fluid or gas temperature at the outlet discharge.

**Flow Rate:** The fluid or gas mass flow rate in lbs/hr.

# The Impedance Heating System

## System Hardware

The standard INDEECO impedance heating system includes a control panel with on/off temperature control, system transformer, thermocouple sensor, electrical termination hardware and isolation kits, if required.

## Standard Hardware

**Control Panel** — The standard control panel is a contactor controlled system with on/off process temperature control.

This control panel includes the following components built into a NEMA 12 enclosure:

- Electronic process temperature controller with thermocouple input and digital temperature indicator
- Electronic high-limit/overtemperature controller with manual or automatic reset and thermocouple input
- 2-pole definite purpose controlling contactor
- Control circuit transformer with fused secondary
- Door interlocking disconnect switch
- Heater circuit fusing
- Illuminated ON/OFF pilot switch
- "OVERTEMPATURE" indication pilot light

Each INDEECO control panel is designed and custom-built in conformance with NEMA and UL standards.



**System Transformer** — A step down system transformer designed for the appropriate KVA rating of the impedance heating system is mounted in a ventilated NEMA 3R enclosure.

Custom-built INDEECO transformers are in conformance with NEMA and UL standards specifically for impedance heating service.

The skin temperature of INDEECO transformers is well within OSHA limits, so they can be located within reach of personnel.

The INDEECO multi-tap design allows for field adaptation to different pipe lengths.

**Cable** — INDEECO can supply selected copper cable with the appropriate terminations for systems.

**Thermocouple Sensor** — Standard Type J thermocouples are designed to be customer mounted directly to the outside diameter of the pipe, under the thermal insulation.

**Isolation Kits** — Each impedance heating circuit is designed to be electrically uniform from end to end. For layouts with "tees" where current divides, and where grounded equipment is connected to the pipes, isolation kits are provided for installation at the customer flanges. Each isolation kit provides a flange gasket, a set of non-conductive bolt sleeves and washers and the required steel washers and nuts. Standard isolation kits are used for process temperatures up to 450° F.

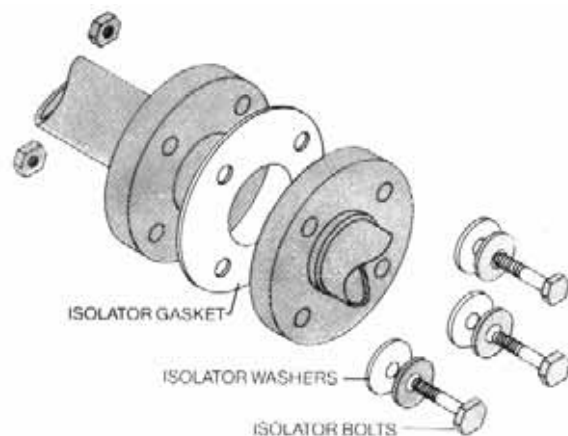

# The Impedance Heating System



**Electrical Termination Hardware** — Standard termination hardware includes stainless steel or copper-plated carbon steel terminal plates, sized and shaped for welding to the pipe. Crimped or bolted connectors are provided for field cable attachment. Specially designed perforated plates are offered for high temperature applications.

## Special Options

Hardware for the standard INDEECO impedance heating system can be upgraded or modified to include any of the following special options:

### Solid State Proportional Control Panel

The SCR controlled system offers precise temperature control up to  $\pm 1^\circ \text{F}$ .

Built-in control components consist of:

- Temperature controller with thermocouple input and digital temperature indication
- Electronic high-limit/overtemperature controller with manual or automatic reset and thermocouple input
- Phase angle fire, single-phase SCR with soft start (current limit)
- Control circuit transformer with fused secondary
- Illuminated ON/OFF pilot switch
- Fan/filter assembly as required for heat dissipation
- 2-pole definite purpose safety contactor
- Door interlocking disconnect switch
- Heater circuit fusing

Optional control components consist of:

- Remote signals and/or interlocks
- Volt meter
- Ammeter

### Temperature Sensors

INDEECO systems can be designed to operate with optional temperature sensors, including Type K thermocouples or RTD's.

### Epoxy Encapsulated Transformers

Epoxy encapsulation is available to protect the copper transformer windings for applications in corrosive environments.

### Control Panel Enclosures

NEMA 4 and NEMA 4X control panel enclosures are available for applications with high humidity, washdown requirements, or corrosive environments.

### System Transformer Enclosures

Transformers are available with stainless steel, copper free aluminum or fiberglass reinforced enclosures for special or corrosive environments. NEMA 4 transformer enclosures are also available.



## System Start-Up

INDEECO provides a start-up manual with every impedance heating system. This includes information on: The hardware, how to install isolation kits and terminal plates, how to run and make cable connections, the start-up procedure, a check list and a troubleshooting guide.

### On-Site Assistance — Extended Warranty

A recommended option is to have a trained INDEECO field service person supervise the initial start-up. Our technician will make sure the impedance heating system is installed and operating properly by making on-site recommendations during the initial start-up of the system. Use of INDEECO field start-up assistance will extend the Standard INDEECO Limited Warranty to 24 months from the date the system is placed in service.

# Application Data Sheet



425 Hanley Industrial Court  
St. Louis, MO 63144  
Ph: 314-644-4300  
Fax: 314-644-5332  
www.indeeco.com

Date \_\_\_\_\_ Job Reference \_\_\_\_\_  
Company Name \_\_\_\_\_  
Address \_\_\_\_\_  
City \_\_\_\_\_ State \_\_\_\_\_ Zip \_\_\_\_\_  
Customer Contact \_\_\_\_\_  
Phone No. \_\_\_\_\_ Fax No. \_\_\_\_\_  
E-Mail Address \_\_\_\_\_  
Submitted By (if different than above) \_\_\_\_\_  
Date Quote Required \_\_\_\_\_

## IMPEDANCE PIPELINE HEATING

### APPLICATION

Pipe Diameter & Schedule \_\_\_\_\_ Pipe Material \_\_\_\_\_ Pipe Length (ft.) \_\_\_\_\_  
Insulation Thickness (in.) \_\_\_\_\_ Insulation Type \_\_\_\_\_ "K" factor \_\_\_\_\_  
Wind Velocity (MPH) \_\_\_\_\_ Indoor  or Outdoor  Min./Max. Ambient Temperatures (°F) \_\_\_\_ / \_\_\_\_  
Material to be heated \_\_\_\_\_ Heat sensitive? YES  or NO

**\*\*\*PLEASE INCLUDE P&ID WITH SUBMITTAL OF QUOTE REQUEST.\*\*\***

### TEMPERATURE MAINTENANCE

Maintenance Temperature (°F) \_\_\_\_\_

### TEMPERATURE RISE

Inlet Temperature (°F) \_\_\_\_\_ Outlet Temperature (°F) \_\_\_\_\_  
Initial heat up time required (hours) \_\_\_\_\_ Product Flow Rate \_\_\_\_\_  
Fluid Properties: Density or Specific Gravity \_\_\_\_ at \_\_\_\_ °F Specific Heat (BTU/Lb/°F) \_\_\_\_ at \_\_\_\_ °F  
Melting Point (°F) \_\_\_\_\_ Latent heat of fusion (BTU/Lb) \_\_\_\_\_  
Describe how the impedance system is to be used: \_\_\_\_\_  
Describe the process loop: \_\_\_\_\_

### HEATER DESIGN

Required KW rating or heat duty (if known) \_\_\_\_\_  
Available power \_\_\_\_\_ volts, \_\_\_\_\_ phase, \_\_\_\_\_ cycle  
Maximum allowable watt density ( $W/in^2$ ) or skin temperature (°F) on heater pipe \_\_\_\_\_  
Heater environment: Non-hazardous Area  or Hazardous Area   
If Hazardous Area: Class \_\_\_\_\_, Division \_\_\_\_\_, Groups \_\_\_\_\_, Ignition Temperature Code \_\_\_\_\_  
Special Items: \_\_\_\_\_

### CONTROLS

Type: ON/OFF  / SCR (modulated)   
Controls mounted: Local  / Remote   
NEMA Type enclosure: 12 , 4 , 4X , With Purge? YES  or NO , 7  (cast aluminum)  
Control Panel Heating/Cooling Required? YES  / NO   
Special Control Items: \_\_\_\_\_

# Limited Warranty

## **Industrial Engineering and Equipment**

**Company (INDEECO)** products are warranted against defects in workmanship, material, design, labeling and packaging. No other warranty, expressed or implied, written or oral, applies. No person other than an officer or the general manager of INDEECO is authorized to give any other warranty or assume any liability.

## **Warranty Period:**

This warranty is effective for eighteen months from the date of shipment of the product from INDEECO's factory, or for twelve months from the date the product is first placed in service, whichever period lapses first.

## **Conditions of Warranty:**

INDEECO products must be installed, operated and maintained in accordance with INDEECO's instructions. INDEECO is not liable for damage or unsatisfactory performance of the product resulting from accident, negligence, alteration, unauthorized repair, improper application or installation of the product, improper specifications or corrosion. INDEECO IS NOT LIABLE FOR ANY INCIDENTAL OR CONSEQUENTIAL DAMAGES. Claims against carriers for damage in transit must be filed by the purchaser with the carrier.

## **Remedy:**

The part or product in question should be returned freight prepaid, to:

**INDEECO**  
**425 Hanley Industrial Court**  
**St. Louis, Missouri 63144**  
**Attention: Return Goods Manager**

If after receipt of the product and the claim, INDEECO finds to its reasonable satisfaction that the product is defective in workmanship, material, design, labeling or packaging, the product will be repaired or replaced or the purchase price refunded at INDEECO's option. There will be no charge to the purchaser for parts or labor. Removal and reinstallation of the product, and shipment of the product to INDEECO for repair or inspection shall be at the purchaser's risk and expense.

THE REPAIR, REPLACEMENT OR REFUND PROVIDED FOR IN THIS LIMITED WARRANTY IS THE EXCLUSIVE REMEDY OF THE PURCHASER. THIS WARRANTY IS EXPRESSLY IN LIEU OF ANY OTHER WARRANTIES, EXPRESSED OR IMPLIED, INCLUDING ANY WARRANTY OF MERCHANTABILITY OR FITNESS FOR A PARTICULAR PURPOSE. THERE ARE NO WARRANTIES WHICH EXTEND BEYOND THE TERMS OF THIS LIMITED WARRANTY.



**INDUSTRIAL ENGINEERING & EQUIPMENT CO.**  
425 HANLEY INDUSTRIAL COURT  
ST. LOUIS, MO 63144  
314-644-4300  
Fax: 314-644-5332  
[www.indeeco.com](http://www.indeeco.com)