



S100 / OPMI pico

OPMI pico from ZEISS

Quality you can see.
Performance you can feel.



Seeing without compromise.

ZEISS OPMI pico



// PRECISION
MADE BY ZEISS

ZEISS OPMI pico

Simple, compact, proven

OPMI® pico from ZEISS, the most frequently sold ZEISS surgical microscope worldwide, is the trusted choice among doctors. It makes details and fine structures clearly visible. It enables you to better visualize the regions of interest and consistently provide your patients with high-quality examinations and treatments.

ZEISS OPMI pico's cost-effective LED illumination meets your standards and needs. The complete integration of the light source makes it easier to clean the system.

Ergonomic seating enables users to conveniently maintain an upright working posture.

ZEISS OPMI pico also features camera options to facilitate patient consultation and documentation, depending on the specific needs in your practice.

The compact and easy-to-use ZEISS OPMI pico offers solid support for even the most demanding applications – whether in restorative dentistry, endodontics, implantology or periodontics:



Restorative dentistry

Quickly detect enamel and dentine fractures as well as approximal caries. High-precision views enable accurate assessment of crown edges, preparation levels and veneers.

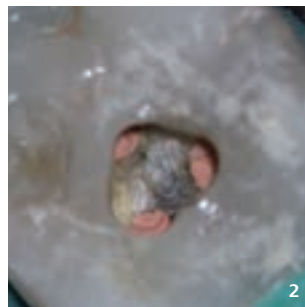

Endodontics

Visualize fine anatomical structures and details of root canals and isthmuses for a clear view right down to the apex.

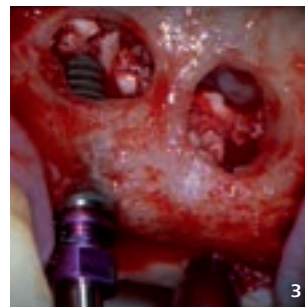

Implantology

Conduct high-precision examinations and implant treatments quickly and confidently. Reliably detect important anatomical structures.



Periodontics

Benefit of support for soft-tissue evaluation and management to assist healing, low scarring and improved cosmetic outcomes.

Application images courtesy of:

¹ Dr. Claudia Cia Worschech, Sao Paolo, Brazil – ² Dr. José Aranguren Cangas, Madrid, Spain – ³ Dr. Behnam Shakibaie, Tehran, Iran – ⁴ Dr. Rino Burkhardt, Zurich, Switzerland

Better view

ZEISS OPMI pico enables you to visualize high-contrast, true-color images – the key to improving the quality of the examination and treatment. With ZEISS OPMI pico, optics and illumination go hand in hand.



Long-lasting LED

For color rendition and light that strongly resembles natural daylight. It is a very cost-effective and virtually maintenance-free light source. The low heat output requires minimal ventilation and generates little noise.



Wide-field eyepieces provide a large field of view with a 3D image
Special diopter settings also make them suitable for eyeglass wearers.

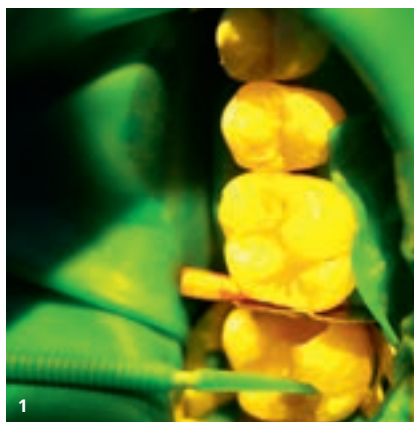

More time for composite modelling
Orange filter prevents premature curing.



Full overview of fine details
ZEISS OPMI pico delivers high-quality images at every magnification level.

¹ Application image courtesy of Dr. Wolfgang Gänster, Illertissen, Germany

Better ergonomics

While treating your patients you can sit comfortably, in an upright, ergonomically correct position for a more relaxed working day.



Adjust the ZEISS OPMI pico to your demands and not vice versa

Reduce or increase the distance for the required treatment field as needed with the patented multi-link design of Foldable Tube f170/f260. With its long reach, this highly flexible system easily accommodates the needs of the user and different positions of the patient.

Full overview – from optimum to maximum

Foldable Tube f170/f260 with the PROMAG function delivers up to 150% magnification on the spot.

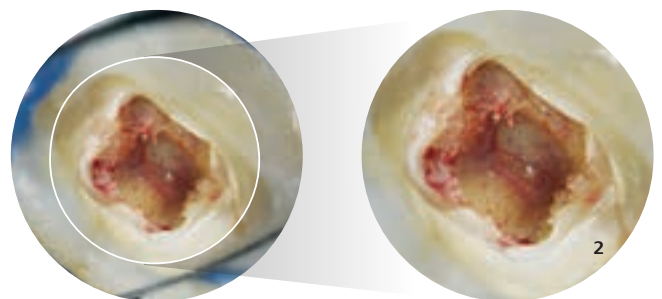

² Application image courtesy of Dr. Bijan Vahedi, Augsburg, Germany

Better education

Real-life pictures are very convincing. ZEISS OPMI pico can accommodate a full HD video camera with recording and streaming, allowing you to present patients with high-definition material to explain procedures.

Benefits of an integrated full HD camera

- All functional elements are completely integrated into the system to avoid workspace clutter
- Ready for use when ZEISS OPMI pico is switched on
- Supports co-observation and documentation
- Simplified cleaning of the housing
- Optional integrated USB recording as well as network streaming

Benefits of live viewing and streamings

- Stream live videos into the network on various devices
- Smart Recording: retroactively record video that occurred in the previous 30 seconds
- Record onto a shared network drive or USB device, facilitating the transfer of still images and HD videos to the patient management software
- Create full HD images during recording or from a recorded video



Better integration

A highly compact instrument with a small footprint, ZEISS OPMI pico fits seamlessly into virtually any practice workflow environment. Simply plug in the cable, switch on the power and the ZEISS OPMI pico is ready for use.

Complete integration of technology and design in the suspension arm for a well-balanced architecture

Functional elements such as the video control console, HD video camera, cables, light sources and light guides are completely integrated into the stand to avoid workspace clutter.

Workplace integration

ZEISS OPMI pico is compatible with a wide variety of dental treatment units from other manufacturers.

The right solution for each dental practice thanks to different suspension system options.

Floor stand

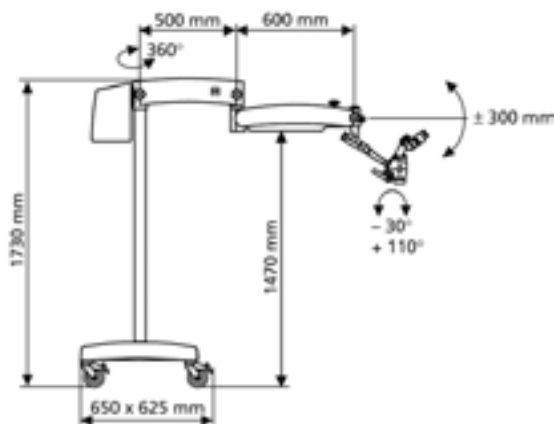

Ceiling mount

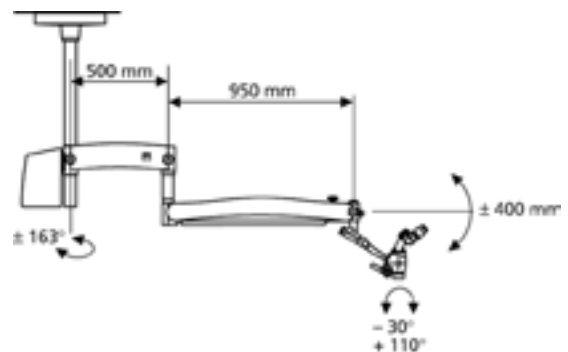

Wall mount (wallplate)

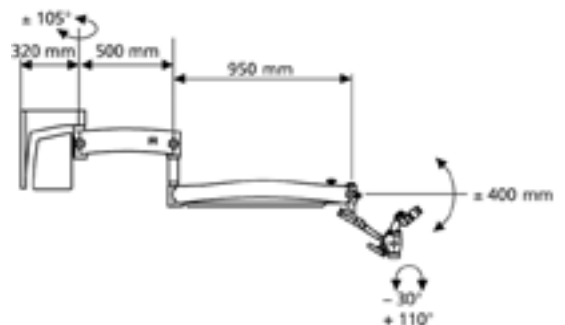

Further space-saving suspension system options are available for the Centro carrier system and specified treatment units.

Technical Data

S100 / OPMI pico from ZEISS

		Packages		
		Startup	Relax	Documentation
Magnification System	Manual 5-step apochromatic magnification changer	●	●	●
Eyepieces	12.5x widefield eyepieces	without reticle	●	●
		with reticle	□	□
	10x widefield eyepieces	without reticle	□	□
		with reticle	□	□
Tube	180° tiltable tube offers ergonomic posture by adjusting the tiltable angle	●	□	●
Objective Lens	f=300 with fine focus offers fine focusing and a working distance of 300 mm to the patient	●	●	●
Illumination System	LED with daylight characteristic for excellent color rendition, virtually maintenance-free	●	●	●
	Orange filter to prevent curing of composites	●	●	●
	Green filter for better contrast of tissue with high blood supply	●	●	●
User Interface	Handgrips at the back, individually adaptable at the push of a button by rotating	●	●	●
Asepsis	Sterilizable asepsis caps for the controls of the microscope, the handgrips as well as for the interpupillary distance adjustment of the 180° tiltable tube	●	●	●
Ergonomics	Foldable f170/f260 tube with the PROMAG function delivers up to 150% magnification on the spot	□	●	□
	Angled optics with rotatable dovetail mount for binocular tubes	□	●	□
Communication	Integrated video camera (full HD 1080p) with live streaming and recording functionality (incl. USB stick, remote control, DVI-DVI video cable for connection to an HD monitor)	□	□	●

● Basic configuration □ Add-ons

Visit our website to find out more about the ZEISS OPTIME service agreements and how they can benefit your workflow.



Carl Zeiss Meditec AG
 Goeschwitzer Strasse 51–52
 07745 Jena
 Germany
www.zeiss.com/opmi-pico
www.zeiss.com/med/contacts

EN_30_010_0186VII SUR.5293 Rev F Printed in Germany. CZ-XII/2018 International edition: Only for sale in selected countries. The contents of the brochure may differ from the current status of approval of the product or service offering in your country. Please contact our regional representatives for more information. Subject to changes in design and scope of delivery and due to ongoing technical development. OPMI and VisionGuard are either trademarks or registered trademarks of Carl Zeiss Meditec AG or other companies of the ZEISS Group in Germany and/or other countries. © Carl Zeiss Meditec AG, 2018. All rights reserved.