

PB92-917004
NTSB/SIR-92/04

NATIONAL TRANSPORTATION SAFETY BOARD

WASHINGTON, D.C. 20594

SPECIAL INVESTIGATION REPORT

MEDIUM/HEAVY TRUCK WHEEL SEPARATIONS

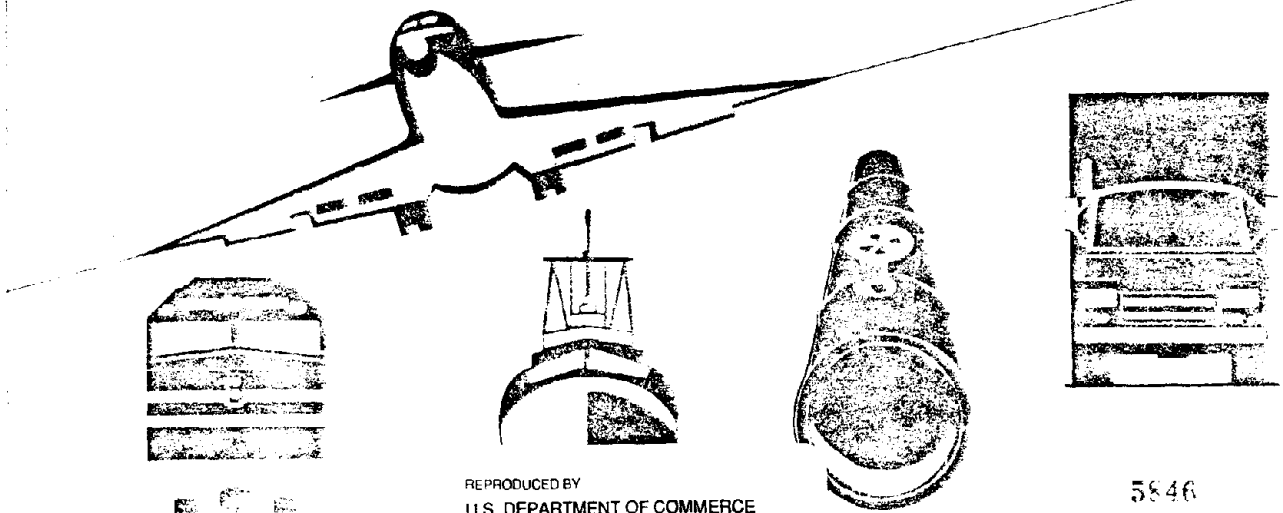

REPRODUCED BY
U.S. DEPARTMENT OF COMMERCE
NATIONAL TECHNICAL INFORMATION SERVICE
SPRINGFIELD, VA 22161

5846

The National Transportation Safety Board is an independent Federal agency dedicated to promoting aviation, railroad, highway, marine, pipeline, and hazardous materials safety. Established in 1967, the agency is mandated by Congress through the Independent Safety Board Act of 1974 to investigate transportation accidents, determine the probable causes of the accidents, issue safety recommendations, study transportation safety issues, and evaluate the safety effectiveness of government agencies involved in transportation. The Safety Board makes public its actions and decisions through accident reports, safety studies, special investigation reports, safety recommendations, and statistical reviews.

Information about available publications may be obtained by contacting:

National Transportation Safety Board
Public Inquiries Section, RE-51
490 L'Enfant Plaza, S.W.
Washington, D.C. 20594
(202)382-6735

Safety Board publications may be purchased, by individual copy or by subscription, from:

National Technical Information Service
5285 Port Royal Road
Springfield, Virginia 22161
(703)487-4600

NATIONAL TRANSPORTATION SAFETY BOARD

WASHINGTON, D.C. 20594

SPECIAL INVESTIGATION REPORT

MEDIUM/HEAVY TRUCK WHEEL SEPARATIONS

ADOPTED: SEPTEMBER 15, 1992

NOTATION 5846

Abstract: In the fall of 1991, a series of five truck-wheel runoff accidents occurred in which a total of seven people died. The seemingly high incidence of similar fatal accidents aroused public and Congressional concern about the potential magnitude of the wheel-separation problem. In November 1991, the Safety Board initiated a special investigation to determine the magnitude of the wheel-separation problem, the types and causes of failures, and the adequacy of current truck wheel inspection and maintenance guidance and procedures. The Federal Highway Administration's Office of Motor Carriers and the National Highway Traffic Safety Administration assisted the Safety Board in the review of accident and inspection records. As a result of this special investigation, the National Transportation Safety Board made recommendations to the Department of Transportation, the Federal Highway Administration, and the American Trucking Associations.



CONTENTS

EXECUTIVE SUMMARY	v
INTRODUCTION	1
SECTION 1--BACKGROUND	3
Wheels	3
Bearings	5
SECTION 2--PAST SAFETY BOARD EXAMINATIONS	7
Evaluation of Wheel Separation Accidents	9
Accidents Resulting from Loose Fasteners	9
Warrior, Alabama	9
Marion, North Carolina	11
Accidents Resulting from Bearing Failure	12
Miami, Florida	12
Greensboro, North Carolina	12
Probable Overtightening Case	15
Doddsville, Mississippi	15
Overview of the Accident Carriers	16
SECTION 3--OTHER DATA SOURCES	18
NHTSA	18
OMC	19
Six-State Survey	20
Estimate of Truck-Wheel Separations Nationwide	21
Potential Underreporting of Accidents/Incidents	22
OMC Inspection Violations Involving Wheels	23
Carrier Data	24
NHTSA'S Defect Investigations	25
Other Independent Studies	28
Accident Data Summary	29
SECTION 4--WHEEL SEPARATION CAUSES AND POTENTIAL SOLUTIONS	30
Accident Causes	30
Case Findings	30
Fatal Accidents	30
OMC's Region 4 Survey	30
Six-State Survey	30
Maintenance Deficiencies Identified	30
Other Support Documentation	31
Examination of Current Maintenance Practices	31
Improper Tightening and Noncompliance With Recommended Procedures	32
Truck and Wheel Manufacturers' Guidelines	32
Initial Inspection	32
Tightening Pattern	33
Recommended Torque	33
Compatible Hardware	34
Contamination of Mating Surface	34
Overtightening	35
Inadequate Inspection Guidelines	36
Replacement Practices for Broken Wheel Studs	38

Wheel Bearing Failures	38
Disc Failures	41
SECTION 5--FEDERAL AND STATE OVERSIGHT	42
Existing Regulations	42
Defect Identification Effort	42
Current OMC and State Inspection Efforts	42
Federal Oversight	43
SECTION 6--CONCLUSIONS	45
SECTION 7--RECOMMENDATIONS	46
APPENDIX A--GLOSSARY	49
APPENDIX B--TYPES OF WHEELS	51
Wheels	51
Spoke wheels	51
Disc wheels	51
APPENDIX C	55
APPENDIX D	59
APPENDIX E	61
APPENDIX F	63
APPENDIX G	66
APPENDIX H	67

EXECUTIVE SUMMARY

In October 1991, the National Transportation Safety Board investigated a fatal accident in which a two-axle cargo van truck lost a front wheel, which rolled into the path of an oncoming schoolbus carrying 46 fourth-graders and their chaperons. The 365-pound wheel smashed through the bus windshield and entered the passenger compartment, killing two children and a chaperon. In the 3 weeks following this accident, two more fatal accidents involving truck-wheel separations occurred in North Carolina; in each instance, a left wheel came off a medium/heavy¹ truck and struck an oncoming pickup, killing the driver.

These three similar accidents, which resulted in five fatalities, generated public and Congressional concern about the potential magnitude of the truck-wheel separation problem. To address these concerns, the Safety Board initiated a special investigation in cooperation with the Federal Highway Administration's Office of Motor Carriers (OMC) and the National Highway Traffic Safety Administration (NHTSA) to study the incidence of truck-wheel separations and determine what could be done to correct the problem.

Between November 1991 and February 1992, Safety Board investigators conducted in-depth examinations of the fatal wheel-separation accidents that occurred in fall 1991, and investigators assessed numerous accident and inspection sources in support of this special investigation. Preliminary analysis indicated that most existing databases did not distinguish between wheel-separation and tire-failure accidents. Investigators surveyed the six States that do maintain separate accident data on wheel defects; the Safety Board also interviewed truck carriers, manufacturers, engineers, and mechanics to obtain information for this special investigation.

Based on its findings, the Safety Board concluded that compared to the 349,000 truck accidents that occur annually, the incidence of wheel separations is small, about 750 to 1,050 per year. From the data accumulated, the Safety Board identified the following maintenance problems:

- * Inadequate inspection guidelines, including frequency and procedures for the proper inspection of wheel fasteners and lubrication of bearings.
- * Lack of uniform maintenance guidelines among manufacturers.
- * Failure by carriers and mechanics to adhere to recommended maintenance guidelines published by wheel manufacturers.

As a result of this special investigation, the Safety Board made recommendations to the Department of Transportation, the Federal Highway Administration, the American Trucking Associations, the Motor Vehicle Manufacturers' Association of the United States, Inc., the Society of Automotive Engineers, and the Truck Trailer Manufacturers Association.

¹Medium/Heavy trucks refer to trucks weighing 10,000 pounds or more.



SPECIAL INVESTIGATION MEDIUM/HEAVY TRUCK WHEEL SEPARATIONS

INTRODUCTION

Throughout its 25-year history, the Safety Board has conducted in-depth investigations of hundreds of highway accidents involving commercial vehicles over 10,000 pounds. Prior to the fall of 1991, Safety Board investigators cited a wheel failure as the causal factor in only one fatal case.²

Beginning in the fall of 1991, the Safety Board investigated a series of five truck-wheel runoff accidents in which a total of seven people died. In the 3-week period between October 14 and November 4, 1991, three fatal medium/heavy truck-wheel separation accidents occurred, including an accident in which the front left wheel broke off a two-axle cargo van truck and careened into the path of an oncoming schoolbus carrying 46 fourth-graders and their chaperons. The 365-pound wheel slammed through the bus windshield, killing two children and fatally injuring a chaperon.

The seemingly high incidence of similar fatal accidents aroused public and Congressional concern about the potential magnitude of the wheel-separation problem. Currently, more than 1.5 million medium/heavy trucks log more than 90 billion miles annually in the United States. The Safety Board therefore initiated a 6-month special investigation in November 1991 to determine the following:

- * Magnitude of the wheel-separation problem.
- * Types and causes of failures.
- * Adequacy of current truck wheel inspection and maintenance guidance and procedures.
- * What safety recommendations, if any, were warranted.

Because it had investigated only six fatal accidents that resulted from wheel separations, the Safety Board recognized that it did not have a database sufficient to perform a comprehensive analysis. The Safety Board therefore researched numerous sources and worked with several transportation agencies to compile the data needed for this special investigation. The Federal agencies providing the greatest assistance included the OMC and NHTSA. The Safety Board also obtained data from six States³ that categorize wheel defects and tire defects separately on their accident report forms.

Between November 1991 and February 1992, Safety Board investigators conducted in-depth examinations of the medium/heavy truck fatal wheel-separation accidents that occurred in fall 1991, and investigators assessed numerous accident and inspection sources in support of this special investigation. Preliminary analysis indicated that most existing databases did not distinguish between wheel-separation and tire-failure accidents. The Safety Board therefore extended

²For information see Highway Accident Report "Multiple Vehicle Collision on State Route 29, near Middletown, California, November 2, 1980," (Docket No. HY-307-81).

³Alabama, Oregon, South Carolina, South Dakota, Texas and Washington.

the research effort through May 1992. Study group members surveyed the six States that do maintain separate accident data on wheel defects; Safety Board analysts also interviewed truck carriers, manufacturers, engineers, and mechanics to obtain information for this special investigation.

While the Safety Board was able to obtain the information necessary for this special investigation, its research efforts revealed variances in the manner in which agencies within the transportation industry report accidents. In addition, analysts recognized that the number of wheel separations is probably underreported because accident reports are not required unless the separation results in damage or injury. This special investigation highlighted a need to collect additional accident data in this area.

In most States, the threshold for reporting property damage accidents is several hundred dollars, and in some areas, a vehicle must be towed away before an accident report must be filed. In the majority of States, if a truck wheel separates and causes no property or vehicle damage, it is not classified as an accident. For this special investigation, highway accidents included vehicular accidents that resulted in a fatality, injury, or property damage.

This special investigation is organized into the following sections:

- Section 1 - Background
- Section 2 - Past Safety Board Investigations
- Section 3 - Other Data Sources
- Section 4 - Wheel Separation Causes and Potential Solutions
- Section 5 - Federal and State Oversight

SECTION 1

BACKGROUND

Wheels

In recent years, the trend in the heavy trucking industry has been to switch from the older style spoke wheel mounting to a disc type mounting that connects the axle hub to the wheel. (See figure 1. Additional information is contained in appendix B.) According to experts, the industry began the switchover soon after the disc wheel was introduced because the wheel used larger radius tires that afforded lower revolutions per mile, better brake cooling, and better running conditions. Despite its improved design, the disc wheel is still subject to frictional forces that can cause failure if the mounting mechanism is not properly adjusted or maintained.

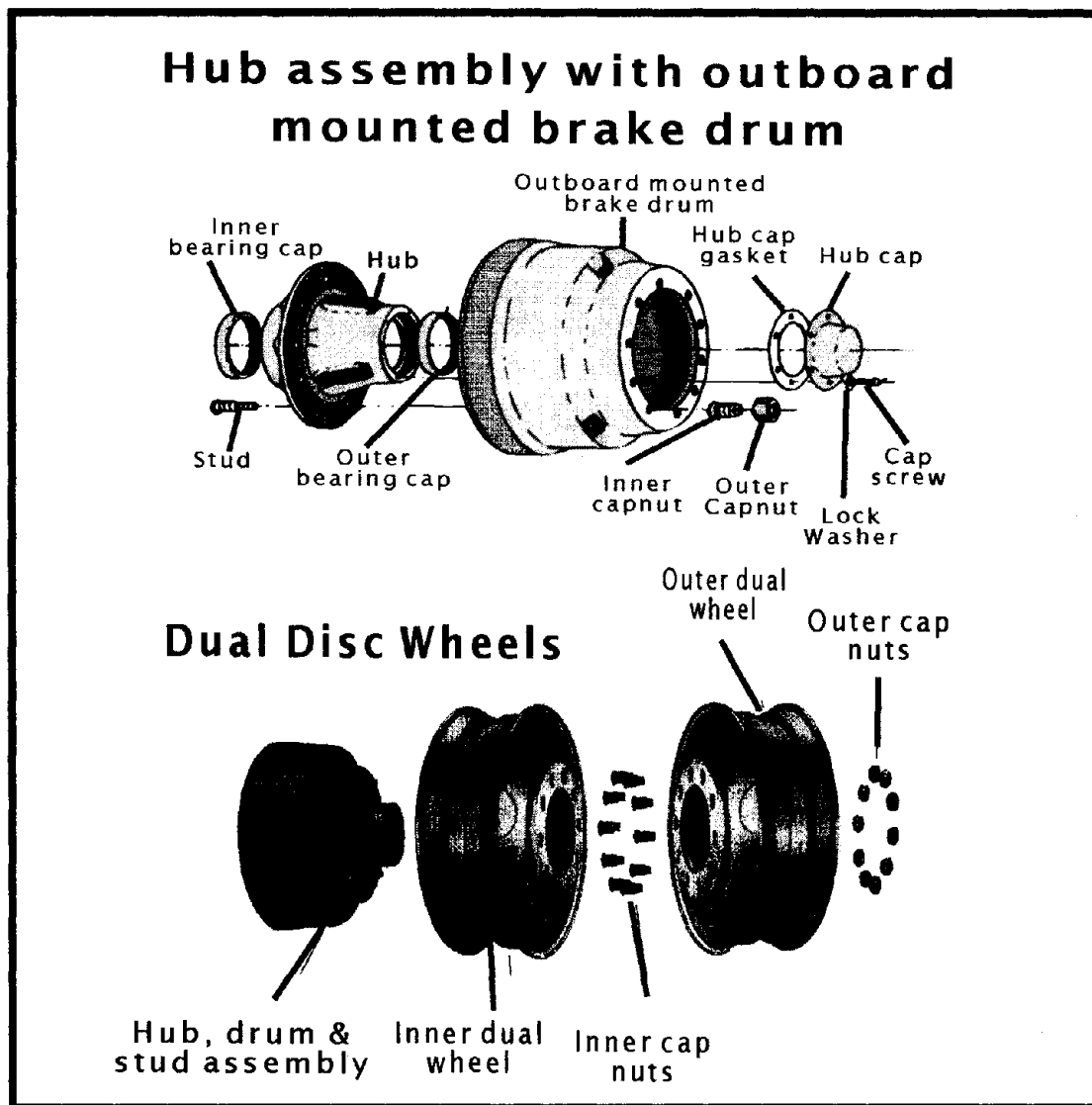

Figure 1.--Top shows exploded view of the hub assembly for a disc wheel. Bottom of illustration shows assembly components of a dual disc wheel.

The disc mounting assembly requires clamping force to eliminate movement at the interface of the wheel and hub. The threaded fasteners (studs and cap nuts) are designed for tensile load only. When tightened to the proper torque⁴, the steel fasteners are stretched in tension, which results in compressive clamping forces⁵ between the wheel and hub. This force increases the friction between the wheel elements. For ball-seat-type wheels, the interface area is between the ball-seat area of the nut and the ball-seat area of the wheel. On pilot mount wheels, friction is where the nut interfaces with the permanently attached washer.

The clamping force of the fasteners must generate frictional force between the wheel and the hub that is greater than the combined forces on the wheel. The wheel is subject to vertical forces from the truck and its cargo; to cornering forces when the truck turns; and to rotational forces from the turning of the wheel, especially during acceleration and braking. If these forces exceed the clamping force of the fasteners, the wheel will move relative to the hub. This action can subsequently create more play in the fasteners, resulting in the nuts backing off, the studs fracturing due to fatigue or overstress, or both.

Proper maintenance procedures are essential to maintain proper clamping forces. To obtain the greatest friction, the mounting surfaces and fasteners must be clean and free from oil or lubricants at the interface. While a drop of oil is recommended for some two-piece nuts, most manufacturers agree that lubricants should be avoided unless use is highly controlled. Manufacturers also advise that service personnel use a torque wrench to obtain the correct tightness. The clamping force must be high enough to hold the wheels in place by friction but not so high as to overstress the threads of the fasteners.

If the yield strength of the bolt/nut material is exceeded during torquing of the fastener, the threads will become permanently deformed and overstress cracking can occur in the thread roots. Microscopic pieces of metal are worn off, creating high and low areas. Uneven areas of paint on the wheels are worn down, and small particles of dirt or rust that remain on the wheel are broken down. As these events take place, the metal connections seat themselves, the stretch on the fasteners is reduced, and clamping force is lost.

To restore clamping force, manufacturers recommend that service personnel retorque the fasteners after an initial run (the first 50 to 100 miles) and at periodic intervals. If the fasteners are not properly retorqued, the wheel will move relative to the hub and put a side load on the fasteners. This side load induces bending forces on the stud, and a bending-fatigue-type failure of the stud will occur if not corrected. The looseness of the fasteners may also result in damage to the hole in the wheel or the wheel pilots on the hub.

Spoke wheels also need periodic retorquing to assure tightness. A spoke wheel assembly is sensitive to proper rim installation and rim-clamp-nut tightening

⁴Torque is the moment of force that produces rotation about an axle. The product of distance and force, torque is expressed in foot-pounds.

⁵Clamping force is the force generated between the interface of the hub and wheel due to friction resulting from forces transmitted from the tightened fasteners. See appendix A for definitions of other terms.

procedures. Overtorquing can distort the circular rims and crush spacers. Undertorquing can cause rim slippage and stud fatigue cracking.

Bearings

Lubricated bearings are used in truck wheel hub assemblies to allow the wheel to turn about the spindle. The four parts of a tapered bearing that are commonly used in large truck wheels are the cup, or outer race; the cone, or inner race; the tapered rollers, which roll freely between the cup and cone; and the cage, which serves as a retainer to maintain proper spacing between the tapered rollers grouped around the cone (see figure 2).

Wheel bearings are either grease- or oil-lubricated. Grease lubrication requires that grease be forced between the cone and cage until it is expelled between the cage and rollers. Grease is also applied to the wheel or hub cavity so that it is even with the inside diameter of the bearing cups. Oil lubrication requires special attention to the type of lubricant used on a tractor's front and rear axle wheel bearings. Bearings are prelubricated prior to installation with a light coating for both types of axles.

If service personnel do not install bearings properly or fail to lubricate the bearings during initial installation or periodic maintenance, excessive friction among the components can result, causing the bearings to overheat. Putting too much or too little force on the bearing when adjusting the caps during assembly will result in additional side loads or allow improper movement of the bearings. In addition, misalignment of the bearings creates improper movement and increased friction. Vehicle overload can also cause stress on the bearing assembly. The friction that results from misalignment and overload will break down and burn the lubrication, causing the metal parts to fuse together and disintegrate.

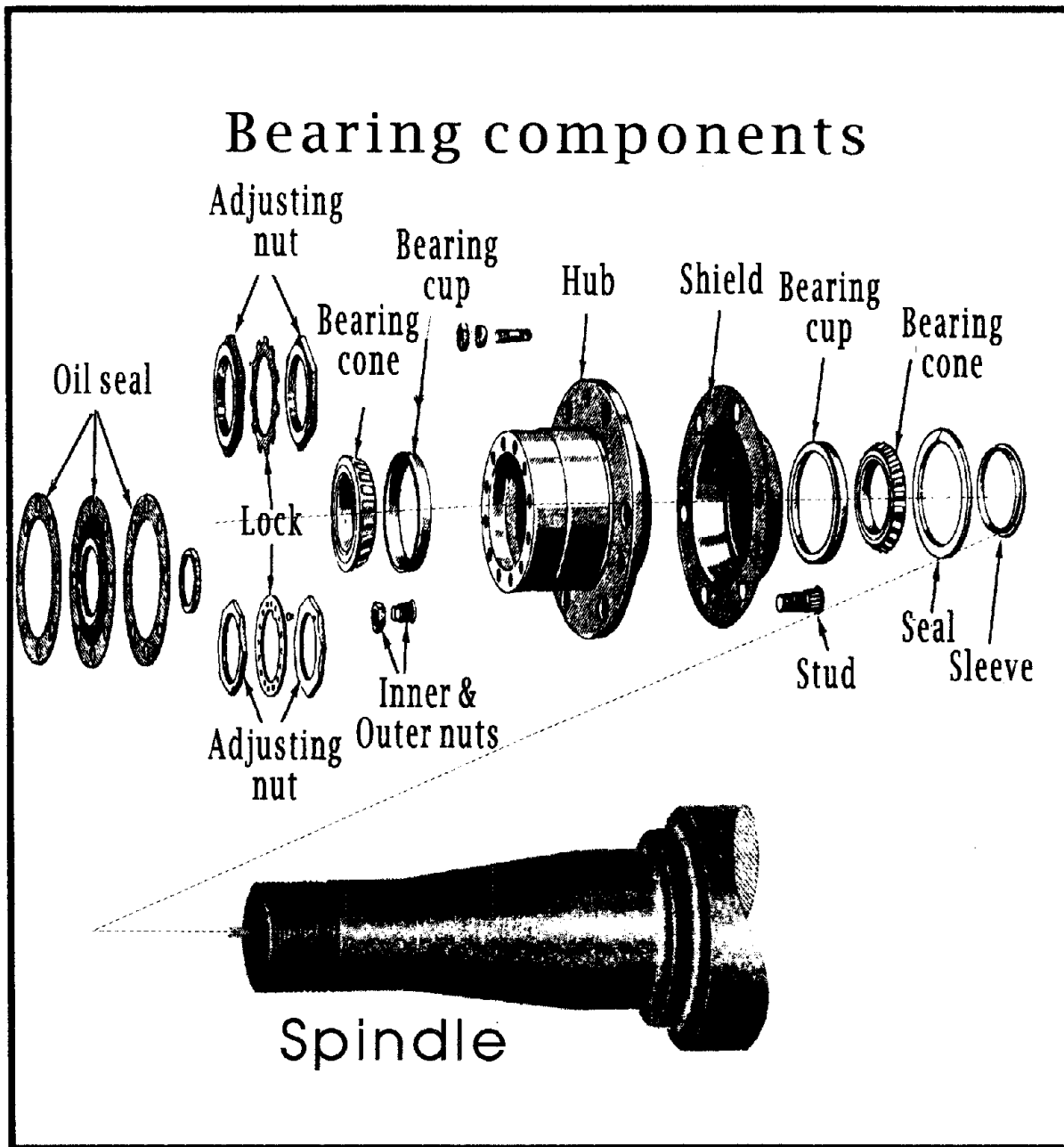

Figure 2.--Components of typical bearing and spindle.

SECTION 2

PAST SAFETY BOARD EXAMINATIONS

On November 2, 1980, a tractor cargo tank-semitrailer that was loaded with drilling mud and water was traveling northbound on State Route 29 near Middletown, California. As the driver started into a right curve, he lost control of the vehicle. The combination rig crossed the highway centerline and struck two southbound vans. The accident resulted in five fatalities and seven injuries.⁶

Postimpact inspection and laboratory analysis revealed that the tractor's left front aluminum wheel hub had failed circumferentially through the outer spindle bearing cup retainer flange. The failure allowed the aluminum wheel to move laterally and vertically about the spindle, resulting in critical control problems for the driver.

Investigators determined that the failure was probably caused by improper installation of the outer bearing cup onto the wheel hub, compounded by repeated tightening of the spindle adjustment nut against the bearing.

This 1980 accident marked the first time that the Safety Board investigated a fatal accident resulting from a wheel failure. For the next 11 years, the Safety Board investigated numerous accidents involving medium/heavy trucks, none of which showed evidence of wheel problems.

In fall 1991, the Safety Board investigated a spate of fatal accidents in which wheel separations were found to be a primary factor. A synopsis of these accidents follows:

Doddsville, Mississippi -- On August 24, 1991, a 1984 Freightliner tractor pulling a loaded 40-foot hopper semitrailer was traveling southbound on U.S. Route 49W when the left front drive axle wheels disengaged from the tractor. The wheels crossed to the right side of the roadway, where they separated. One of the wheels careened onto private property, where it struck and fatally injured a pedestrian.

Warrior, Alabama -- On September 19, 1991, a 1986 tractor in combination with a loaded 1985 two-axle Great Dane 40-foot van semitrailer was traveling southbound on Interstate 65 and descending a grade when the left front dual wheels disengaged from the trailer. The loose wheels crossed the highway median and struck an oncoming 1989 Oldsmobile passenger car, killing the passenger and seriously injuring the driver. (See figure 3.)

Miami, Florida -- On October 14, 1991, a 1986 Mack two-axle cargo van was traveling eastbound in heavy traffic on State Route 836 when the left front wheel, hub intact, disengaged. The loose wheel angled left across the highway, bounced over the 32-inch-high concrete center barrier, and struck an oncoming, occupied schoolbus. The wheel entered the front of the bus, killing two children and fatally injuring a chaperon, who died 10 days later. (See figure 4.)

⁶For additional information, see Highway Accident Report "Multiple Vehicle Collision on State Route 29, near Middletown, California, November 2, 1980," (Docket No. HY-307-81).

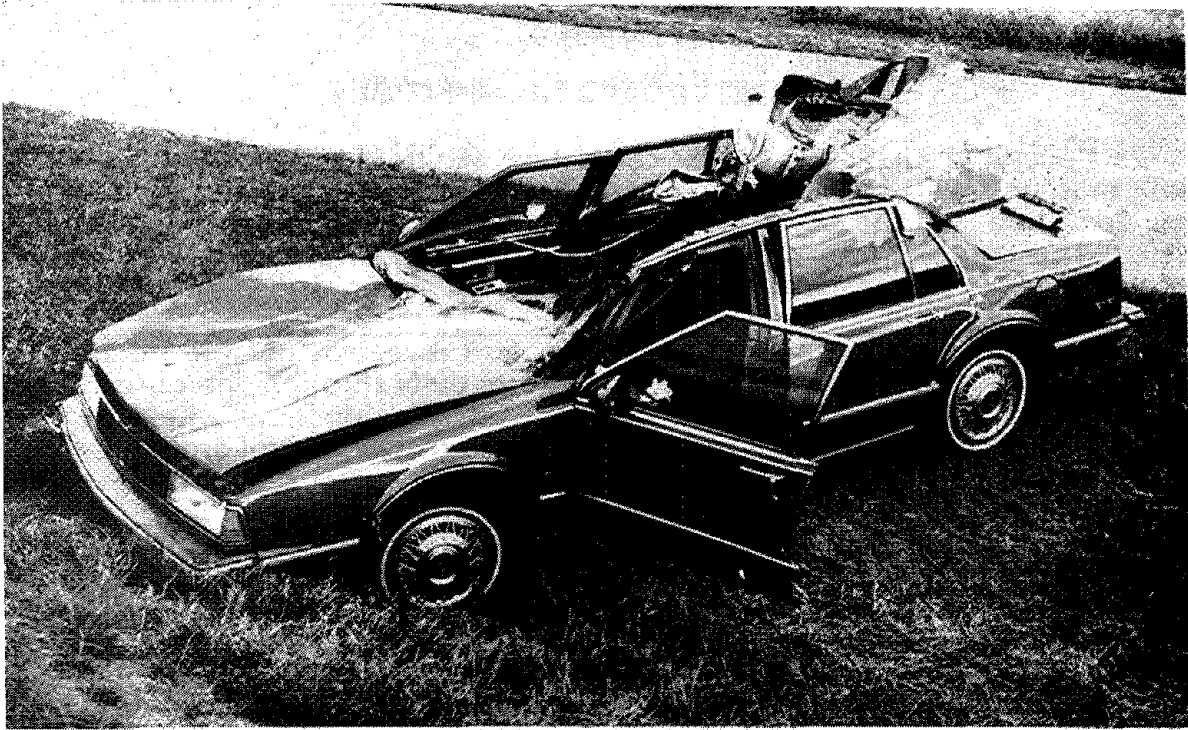

Figure 3.--Damage to a 1989 Oldsmobile struck by a left front dual wheel in Warrior, Alabama.



Figure 4.--Left photograph shows damage to Miami, Florida, schoolbus. Right photograph shows interior damage caused when the truck wheel penetrated the front windshield of the bus.

Marion, North Carolina -- On October 16, 1991, a 1989 Freightliner tractor in combination with a 40-foot semitrailer was traveling northbound on U.S. Route 221 when the left front drive wheels disengaged from the tractor. The wheels separated, and one careened into an oncoming pickup in the southbound lane, killing the driver. (See figure 5.)

Greensboro, North Carolina -- On November 4, 1991, a 1982 Ford F600 two-axle flatbed truck was traveling southbound on Interstate 85 when the left front wheel, hub intact, disengaged from the left front spindle of the truck. The wheel angled left across the earthen median and into the northbound lanes, where it rolled for about 312 feet before striking a 1988 Ford F150 pickup truck. The wheel crushed the roof and driver's side door of the pickup, killing the F150's driver. (See figure 6.)

Evaluation of Wheel Separation Accidents

For this special investigation, analysts compared the findings from the Safety Board's 1991 investigations to determine any commonalities in the accidents. The Safety Board found that two resulted from loose fasteners, two resulted from seized bearings, and one potentially resulted from overtightened nuts.

In addition, the Safety Board believes that the 1980 accident near Middletown had the potential to be a wheel-separation accident because if the driver had not lost steering control and been involved in the accident, the bearing failure may have resulted in the vehicle's front left wheel separating.

Accidents Resulting from Loose Fasteners

Warrior, Alabama -- In the postcrash examination of the tractor/semitrailer, the Alabama Department of Public Safety investigators reported rust streaks near the stud bolts and nuts of the vehicle's third axle leftside, fourth axle rightside, and fifth axle rightside. Figure 7 shows the sheared bolts on the hub assembly of the accident vehicle.

Examination of four bolts from the wheel that separated from the trailer disclosed surface markings indicative of fatigue cracking. Most of the fractures were representative of rotating bending fatigue. If a nut is loose on a stud, when the wheel turns, the stud will bend and become subject to fatigue from all directions. Analysis showed that fatigue markings extended completely through the fractured cross section of three of the four studs examined. The full extent of cracking in the fourth stud could not readily be determined.

The Safety Board concluded that such fatigue would occur if the studs were not properly tightened. Inadequate clamping forces between the wheel and hub allow relative movement between these members. When this occurs, studs are subjected to rotating bending stress when the wheel rotates.

The investigators who examined the Accuride Corporation wheel and the Webb Wheel Product, Inc., hub determined in independent examinations that the dual wheels were contaminated with rust and old paint, that the stud holes were elongated, and that the raised metal from the elongations caused by the loose nuts precluded the full development of clamping force.

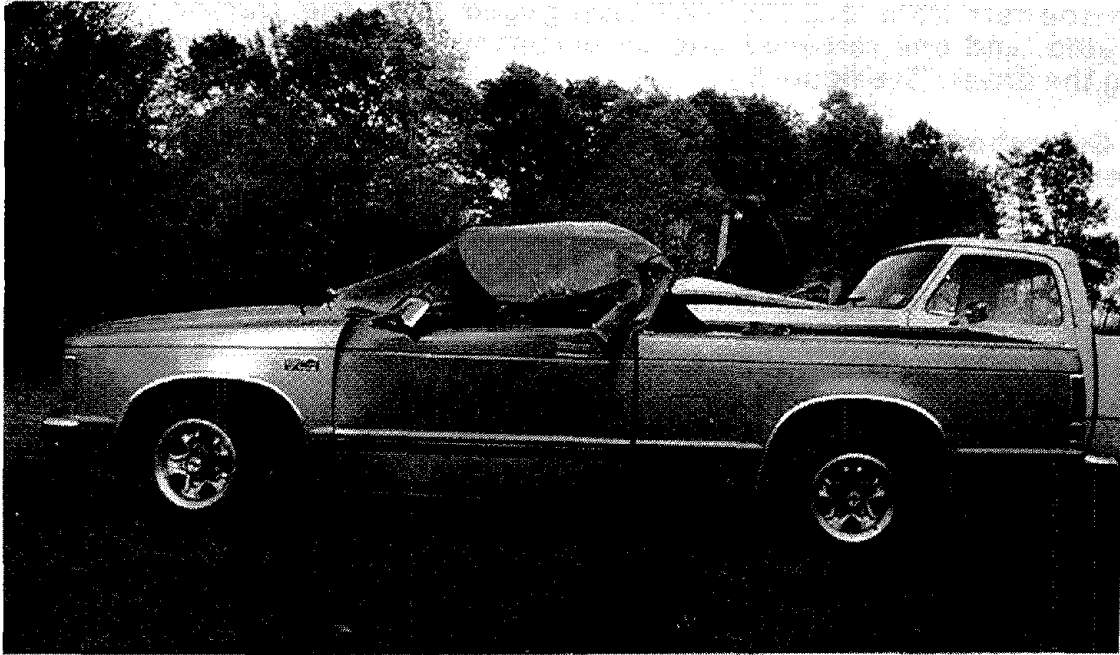

Figure 5.--Damage sustained by pickup truck near Marion, North Carolina.



Figure 6.--Damage sustained by pickup near Greensboro, North Carolina.

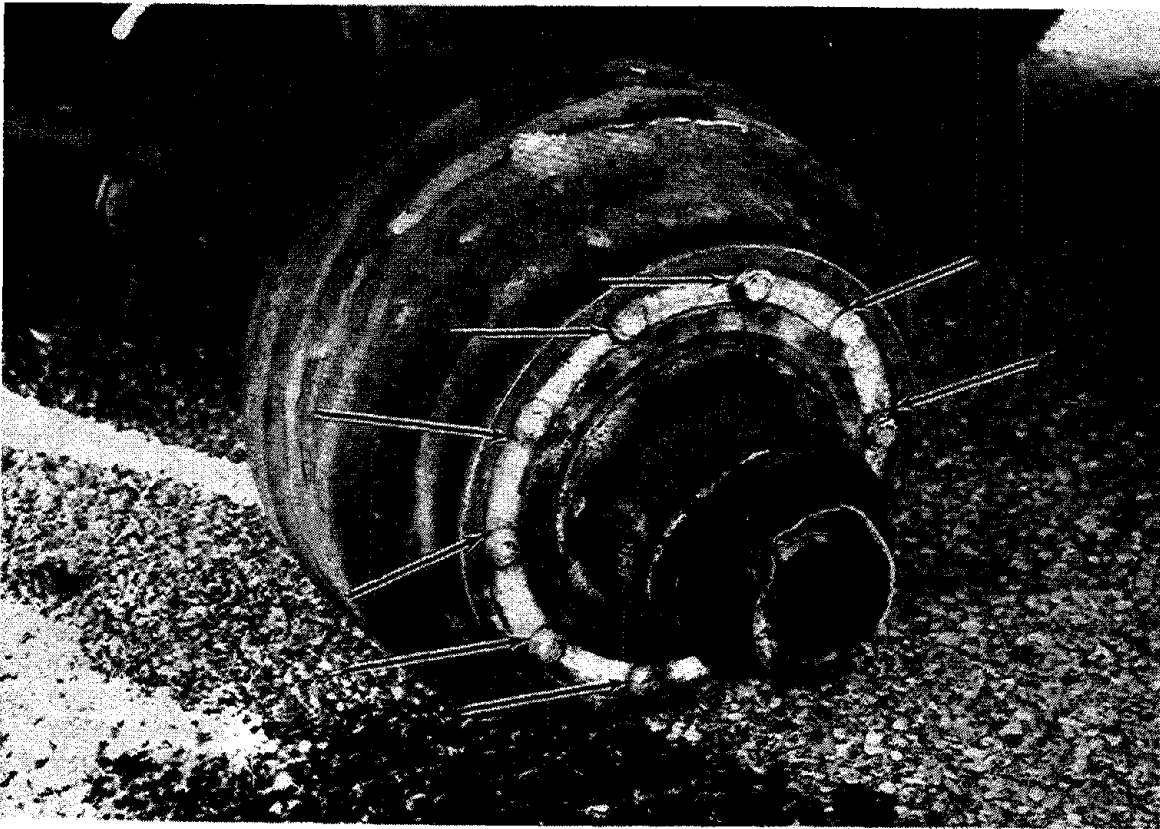

Figure 7.--Hub assembly showing fractured bolts. Arrows point to rust build-up.

Rust, metal burrs, and paint build-up between the wheel and hub can prevent the surfaces from fully contacting each other during tightening of the nuts. During service, rust, paint, and metal burrs can flatten or wear, causing a loss of clamping force and reduced torque on the nuts. The loss of force would allow the nuts to back off. The loose nuts cause excessive rotating bending stress in the stud that eventually results in stud failure.

Marion, North Carolina.--In its investigation of this accident, the Safety Board found that the wheel assemblies on this vehicle were painted steel rims that had been stripped and repainted. The wheels had been installed on the tractor 58,000 miles before the separation accident. The carrier contracted an independent consulting firm to examine the vehicle's wheels after the accident. In the postcrash examination, investigators found paint build-up on the wheels. Laboratory analysis performed by the carrier's consulting firm showed that paint deterioration had caused a loss of clamping force, which in turn allowed the articulated cone washer lock nuts to loosen.

Motor Wheel, Inc., manufactured the hub system on the tractor. Motor Wheel's system has a hub pilot that consists of four machined flats situated between every other wheel mounting stud. The consulting firm's examiner found that the bearing surfaces supplied by these four pilots were heavily worn. He also found the corresponding rim areas heavily worn, "...apparently from relative movement at the contact surface." In his report of findings, he stated

...the most probable scenario for the loss of torque on the mounting nuts appears to be...[due to the wear] of the paint coats on the mating surfaces of the rims under the initial clamping force.... The movement of the paint coat from under the mounting nut would allow some loss of the elastic elongation present in the cone washer and the wheel mounting bolt. The...[loss of] the paint coat on the rims can be observed in the photographs [see figures 8 and 9] of the wheel assemblies....

Accidents Resulting from Bearing Failure

Miami, Florida--At the postaccident inspection, Safety Board investigators were assisted by two engineers from Mack Trucks, Inc., the manufacturer of the accident vehicle. Investigators found a cotter pin fragment embedded in "cooked," or overheated, grease on the inside surface of the cap (see figure 10). The heat had fused the nut, lockwasher, and inner race of the outer bearing (see figure 11). A portion of the fused pieces had considerable accumulated rust. The excessive heat had also burned up the bearing and destroyed the bearing cage.

The investigators found the roller bearings had some flat spots, "galling," and "pitting" (see figure 12). According to engineers, these deficiencies are characteristic of "long-time" wear resulting from a lack of grease, improper grease, or the presence of water. When they checked the hub cavity, investigators found that the amount of grease was "almost unmeasurable," as opposed to 9 ounces specified by the manufacturer.

On-scene investigators concluded that lack of maintenance, specifically, proper lubrication, caused the wheel bearing to seize. They determined that the lack of grease on the wheel bearing, together with accumulated rust on the spindle and outside bearing, resulted in the following scenario:

1. The bearing progressively seized and overheated.
2. The bearing fused with the retaining washer and retaining castellated nut.
3. This "fused assembly" started to rotate according to the forward wheel motion.
4. The lock tab on the retaining washer broke.
5. The cotter pin sheared off.
6. The fused assembly started to unscrew progressively until the complete wheel assembly became loose.

Greensboro, North Carolina--At the postaccident field examination, investigating officials found metal deposits on the race of the outer wheel bearing. Inside the hub, examiners found cotter pin pieces, one of which appeared "blue from heat." The bearing cone of the outer wheel bearing had "deep grooving." The outer wheel bearing roller cage had been destroyed; a portion of it was found on the spindle between the inner wheel bearing and the cone of the outer wheel bearing. From the outer wheel bearing, investigators recovered three rollers, each of which had flat spots and "scoring and wear." They noted a bluish color on a portion of the spindle and also on the grease-free cone of the outer wheel bearing.



Figure 8.--Mounting face wear on outboard wheel assembly.

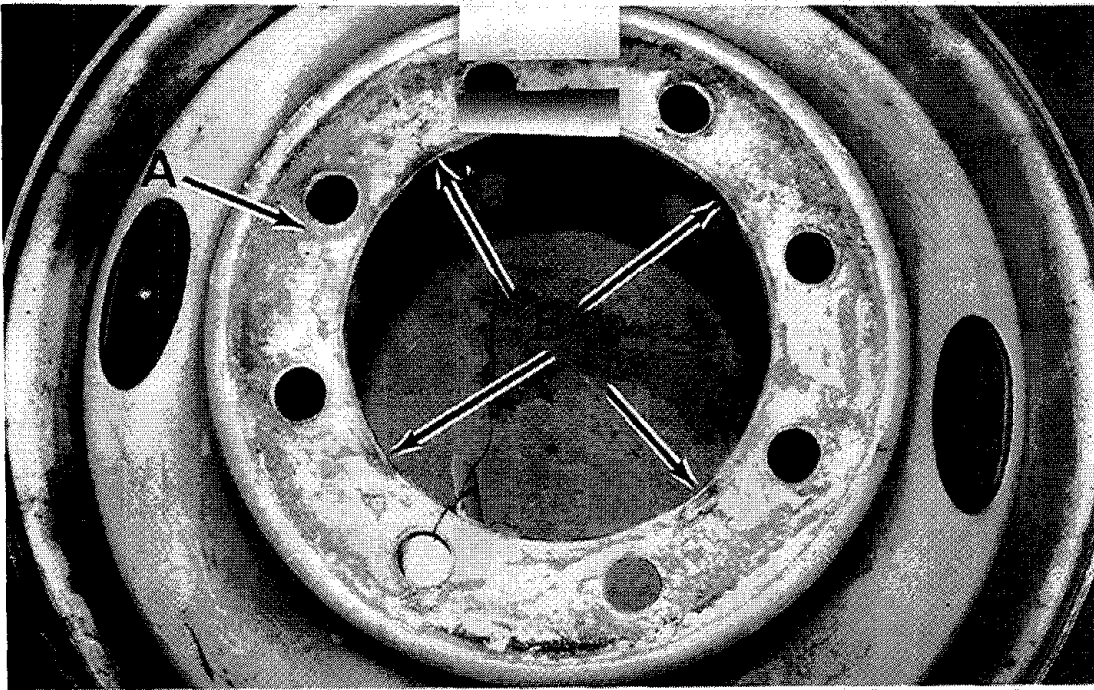

Figure 9.--Mounting face of inboard wheel assembly. Area at A shows a loss of paint from the mounting face. The inside rim between the bolt holes shows wear from the pilots.

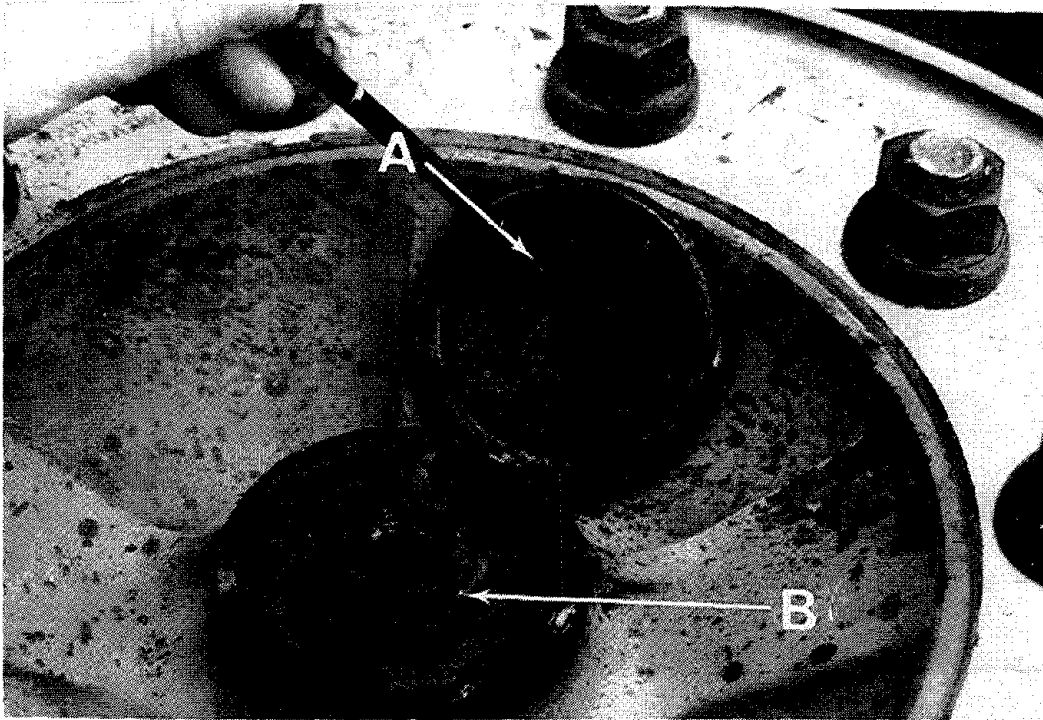

Figure 10.--View of overheated grease from the left front wheel assembly. (Arrows A and B point to the hub cap and lock nut, respectively.)

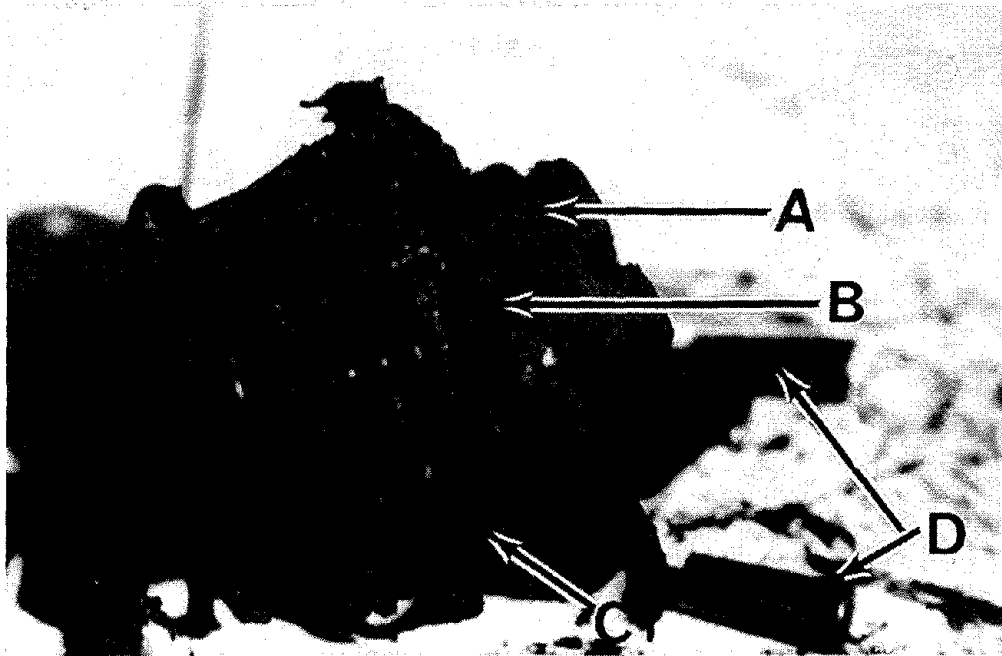

Figure 11.--View of nut (A), lockwasher (B), and inner face of outer bearings (C) welded together. (Arrow D points to the bearings.)

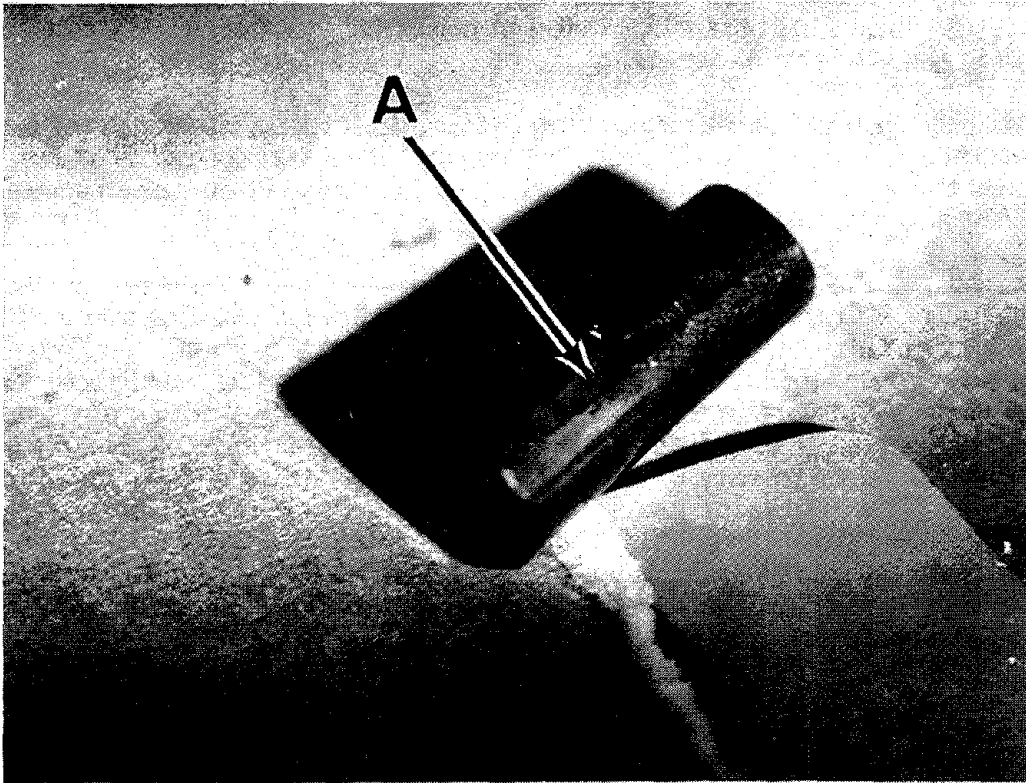

Figure 12.--Roller bearing with flat spots (A) and pitting.

The motor carrier whose truck was involved in the accident commissioned an independent consultant to do a metallurgical study of the bearing and hub assembly. The consultant confirmed that a bearing failure had occurred. The consultant expressed concern about the difference between the maximum weight allowed by the State for this vehicle -- 28,000 pounds based on the bridge formula⁷ -- and the manufacturer's gross vehicle weight (GVW) rating for the truck -- 19,700 pounds. The consultant indicated that he could not positively state that the vehicle never exceeded the GVW when it was carrying a full load of equipment. He further stated that the owners may have occasionally exceeded the manufacturer's GVW because the maximum load limit allowed by the State was greater. The consultant expressed concern about the impact of the additional load on the truck's axle and bearings. If the truck exceeded the GVW, the carrier was violating OMC regulations and overloading the truck, which can result in bearing failure.

Probable Overtightening Case

Doddsville, Mississippi.--The truck tractor in this accident had steel disc dual wheels attached to the hub and drum assembly by 10 stud bolts. The inner wheel of the assembly was fastened to the hub, drum, and stud assembly by 10 inner cap nuts. The outer wheel was mounted over the inner cap nuts and was fastened to the

⁷A formula based on axle load and axle spacing used to calculate stresses that a truck exerts on a bridge.

assembly by the outer cap nuts. Investigators who conducted the postaccident examination found that the studs failed at the outer side of the hub assembly, which resulted in the wheel separation.

According to the carrier operating the accident truck, the company had its own maintenance facility in Sunflower, Mississippi. The carrier-owner stated that he tightened the wheel nuts on his vehicles using a Chicago Pneumatic Tools air wrench (CP-797-6) and had just recently had the shop wrench serviced.

Based on the carrier's comments, the Safety Board contacted the Chicago Pneumatic Tools Company, which provided Safety Board investigators with customer literature. The tool company's literature recommends that the CP-797-6 be operated with a constant or regulated shop line pressure of 90 psi. The manufacturer does not recommend air pressure in excess of 90 psi because it will produce imprecise output torque and decrease tool life. This particular impact wrench, like many others, allows the operator to vary or regulate the air flow to control torque output and tool speed. This regulator provides a working torque range, after 3 seconds of impacting, from 150 ft-lb to 900 ft-lb depending upon how the operator adjusts the tool. With an impact wrench such as the one used in this investigation, an operator can overtorque the fasteners by setting the wrench at too high a pressure and/or applying the wrench too long.

The manufacturer's recommended torque for both the inner cap nuts and the outer cap nuts of the accident tractor's dual wheels was 450 to 550 ft-lb. According to the carrier-owner, the shop's air pressure line was set at 120 psi. High air line pressures and heavy-duty air impact wrenches have the capability to greatly exceed the normal torques of 400 to 550 ft-lb required for most large truck wheel nuts, especially when the line air pressure is 33 percent higher than recommended.

Torques of 1,400 ft-lb will deliver a torque level in excess of the desired 450 to 550 ft-lb, causing overstress on the threads of the studs and the nuts. To avoid these higher torques and potential resulting stress, some carriers use a regulator to obtain more constant line pressure.

From interviews conducted and other available information, the Safety Board believes the evidence points to overtightened fasteners as the causal factor in the Mississippi accident. However, the Safety Board did not receive timely enough notification of this accident to obtain stud or wheel hardware for laboratory analysis.

Without the studs, Safety Board analysts could not determine if failure resulted from under- or overtightening. However, given the carrier's maintenance procedures and equipment, overtightening seemed more probable.

Overview of the Accident Carriers

The carriers whose vehicles were involved in the five fatal accidents that the Safety Board investigated represented a diverse segment of the trucking industry.

The companies ranged in size from a one-owner/driver, one-vehicle operation to an incorporated carrier that had 1,000 tractors and 2,700 trailers and operated out of 17 terminals across the United States. One company used tractors that it owned as well as tractors that it leased in its interstate transport operation.

Three of the carriers had their own maintenance facilities. One carrier drove only leased vehicles and did not have its own maintenance facility. The companies' preventive maintenance programs varied according to the size of the carrier; the smallest performed minimal maintenance when the owner bought fuel and the largest had a systematic, well-documented program.

Despite the variances in the size and scope of operation, the Safety Board found deficiencies in the maintenance practices of all the carriers. In each instance, the carrier and/or the carrier's service technician(s) failed to follow wheel manufacturer's recommended maintenance procedures. (See section 4 for additional information.)

SECTION 3

OTHER DATA SOURCES

To obtain a database sufficiently large to determine the scope of the wheel-separation problem, the Safety Board worked with representatives from two of the Department of Transportation's (DOT's) regulatory agencies, the NHTSA and FHWA's OMC, which oversees carriers involved in interstate commerce. The Safety Board also surveyed police accident records from six States⁸, looked at inspection data and recall information, and conducted a literature search.

NHTSA

As part of its information-gathering function, the NHTSA maintains the Fatal Accident Reporting System (FARS). The NHTSA obtains copies of all police investigation reports involving fatal accidents and codes pertinent information for computer input to data files. The NHTSA uses the computerized FARS for identification of trends and potential safety issues.

A review of the FARS data for the period January 1989 through December 1991 showed that fatal highway accidents numbered more than 117,000. Of that total, about 12,300 fatal accidents involved medium/heavy trucks. FARS data include the category "Related Factors--Vehicle Level" that identifies "vehicle defects...indicated in the police report." NHTSA's reporting system allows for the differentiation between tire defects and wheel defects. However, a preliminary examination of the FARS data revealed that in 157 cases, NHTSA analysts were unsure whether a tire blowout or a wheel separation had occurred.

To ensure the accuracy of the findings for this Safety Board investigation, NHTSA analysts requested that State highway agencies provide copies of original police fatality reports in which medium/heavy vehicles were identified as having been involved and tire/wheel defects were identified as causal.

A review of the 157 police reports received showed that 18 fatal accidents resulted from truck-wheel separations between January 1989 and July 1991. In addition to the reports specifically requested by the NHTSA, the Highway Division of the Oregon Department of Transportation sent the Safety Board a copy of a police report not originally categorized as a tire/wheel defect accident in the FARS database. The Oregon submission brought the fatal accident total for the 30-month period to 19.

Of 12,300 reported fatal medium/heavy truck accidents for 1989 through 1991, 24 involved wheel separations. (See appendix C for additional information.) These accidents included the 5 that resulted in the fall 1991 Safety Board investigations, the 18 identified during the investigation group's review of police records requested by the NHTSA, and the 1 identified in the police report submitted by Oregon. Safety Board analysts looked at all 24 accidents to determine any commonality and found none. Our findings in the areas of fatality type and location of separation follow.

⁸Alabama, Oregon, South Carolina, South Dakota, Texas, and Washington.

Fatality type - In 20 cases, the errant wheel rolled into the path of an oncoming vehicle; in 2 cases, the wheel hit a pedestrian; in 2 cases, the wheel loss caused the vehicle to overturn and burn.

Location of separation - In 15 cases, the wheel separated from the tractor or power unit; in 7 cases, the wheel separated from the trailer. Data for the remaining cases were not available. In 16 cases, the left wheel separated; in 6 cases, the right wheel separated; in 2 cases, the spare tire separated.

OMC

If a vehicle is involved in an accident that meets the criteria listed at Part 394.3, Chapter III, 49 CFR (see figure 13), the carrier must submit a report of the accident on Form MCS 50-T to the OMC "within 30 days after the motor carrier learns or should have learned that a reportable accident occurred."

- (1) The death of human being; or
 - (2) Bodily injury to a person who immediately receives medical treatment away from the scene of the accident or;
 - (3) Total damage to all property of \$4,400 or more based upon actual cost or reliable estimates.

Figure 13.--Criteria for a "reportable accident."

For the wheel-separation investigation, Safety Board analysts requested that OMC compile all MCS 50-T reports for the period from January 1989 through July 1991 to determine the incidence of accidents resulting from wheel defects. The OMC report forms showed that nationwide over 540 accidents resulted from tire/wheel defects during the 30-month period. As in the case of most police reporting forms, OMC's Form MCS 50-T does not differentiate between wheel and tire defects. The Safety Board and other members of the investigation group suspected that most of the 540 tire/wheel accidents reported to the OMC were tire blowouts.

The investigation group therefore decided to look at a regional survey of carriers that the OMC was conducting in its Region 4.⁹ The OMC had initiated the carrier survey in late 1991, after the third fatal truck-wheel separation accident occurred in the agency's southeast region. The OMC analysts sent questionnaires to

⁹OMC's Region 4 includes Alabama, Florida, Georgia, Kentucky, Mississippi, North Carolina, South Carolina, and Tennessee.

84 carriers that had reported accidents resulting from tire/wheel defects between 1989 and mid-1991. (See appendix D.)

During the period that the Safety Board was conducting the wheel-separation investigations, the OMC received 40 survey responses from motor carriers in Region 4. Safety Board analysts examined 38 of these cases. Analysts eliminated one case because the carrier reported that a bearing seized but the wheel did not separate. The Safety Board also did not consider one wheel-separation case involving a bus.

A review of the 38 reported wheel separations revealed no trends. The Safety Board believes that because the sampling was small, no statistical significance should be placed on the results. The following data demonstrate the randomness of the Safety Board's findings. In categories where the total number of separations does not equal 38, available documentation did not identify the factor.

Left/right-side separation - Twenty cases involved left-wheel separations and 18, right-wheel separations.

Truck type/manufacture - Wheel separations from tractors totaled 15, including 5 Freightliner tractors, 4 Kenworth tractors, and 3 Mack tractors. Separations from semitrailers totaled 18, including 4 Great Danes and 4 Trailmobiles. Double trailers totaled 2 and straight trucks, 2. Data for the remaining cases were not available.

Type of wheel - Disc wheel separations totaled 26; spoke wheel separations, 4.¹⁰

Time since inspection/servicing - In 29 of the 38 cases, carriers reported the amount of time since the vehicle had received its last maintenance and/or inspection, which may or may not have included inspection of the wheels. In 21 cases, work or inspection had been performed less than 4 weeks prior to the wheel separation.¹¹ In 8 cases, the vehicle had received maintenance within 7 days of the wheel separation. Of these 8 cases, 4 separations occurred within 72 hours of wheel maintenance (1 separation followed same-day replacement of seals, 1 separation followed same-day replacement of studs, 1 separation occurred 1 day after the wheel's nuts had been tightened by hand, and 1 separation occurred 3 days after the bearings had been replaced). In 16 questionnaires, 9 carriers admitted to not following the manufacturer's recommended maintenance procedures.

Six-State Survey

Because OMC data files do not include carriers engaged in intrastate commerce, Safety Board analysts tried to obtain more complete information by surveying State highway enforcement agencies. However, a review of State accident

¹⁰A disc wheel is a permanent combination of a rim and a disc used to attach the hub. A spoke wheel is a wheel constructed such that one or two demountable rims are clamped to the wheel disc, which also serves as a hub support for the brake drum or disc brake rotor. See section 1 and appendix A for illustrations and a further description.

¹¹The Safety Board excluded those carriers reporting the required routine daily inspections by drivers.

reports revealed that only six States separate wheel defects from tire defects on reporting forms. The Safety Board asked the highway agencies of the six States -- Alabama, Oregon, South Carolina, South Dakota, Texas, and Washington -- to search their files for reports of truck accidents resulting from wheel defects.

Five of the six States reported a total of 274 wheel-separation accidents during 1989 and 1990 (see figure 14). South Carolina found no accidents in its files that involved medium/heavy trucks and wheel separations.

Wheel	Separation Accidents	Injury Accidents	Persons Injured	Persons Killed
Alabama	85	12	17	0
Oregon	35	8	10	3
South Carolina	0	0	0	0
South Dakota	12	4	4	0
Texas	103	23	30	0
Washington	<u>39</u>	<u>5</u>	<u>8</u>	<u>0</u>
TOTAL	274	52	69	3

Figure 14.--Truck wheel separations--1989-1990.

Estimate of Truck-Wheel Separations Nationwide

The Safety Board looked at various surrogate measures outlined in the FHWA's Highway Statistics--1989 to extrapolate a nationwide estimate of medium/heavy truck wheel-separation accidents based on the findings from the six States. The six surrogate measures for which analysts computed the ratio of the six-State total to the national total included population (13.28 percent), licensed drivers (13.43 percent), licensed truck tractors (17.94 percent), licensed trucks (16.92 percent),¹² motor fuel consumed (14.5 percent), and fatal accidents (15.5 percent).¹³

Safety Board projections of state data based on the percentages above indicate that nationwide, the incidence of medium/heavy truck-wheel separation accidents is small, about 750 to 1,050 per year, compared to the total number of truck accidents, about 349,000 annually. Wheel-separation accidents constitute about 0.3 percent of all truck accidents. From January 1989 through December 1991, fatal accidents resulting from wheel separations totaled 24, compared to 12,300 medium/heavy truck fatal accidents for the same period.

¹²Includes pickup trucks.

¹³Summary of Medium & Heavy Truck Crashes in 1989, U.S. DOT-NHTSA, DOT HS 807 739, July 1991.

Potential Underreporting of Accidents/Incidents

The Safety Board found two cases of underreporting to the OMC. The OMC accident reports for Warrior, Alabama, and Doddsville, Mississippi, indicated no "mechanical defects or failures apparent on the vehicle at the time of the accident." On both reports, under the column heading "Mechanical defects or failures," "Not applicable" had been checked; the box entitled "Wheels and tires" had been left blank.

The Safety Board learned of another wheel-separation accident that occurred on November 17, 1991, in Harrisburg, Pennsylvania, only after a victim from the accident called our regional office to discuss the incident. According to police reports, a 1984 Marmon tractor/ semitrailer was southbound on Interstate 83 when the right rear tandem dual wheels disengaged from the unit. The wheels bounced over the 4-foot-high concrete median barrier separating the northbound and southbound lanes and struck two northbound vehicles, a 1978 Buick and a 1985 Cadillac. The 70-year-old driver of the Cadillac was taken by ambulance to a local hospital, where he was treated and released; the Cadillac, valued at \$5,900, was declared a total loss.

The Harrisburg accident met two criteria that required the carrier to file a report to OMC: injury that required medical treatment away from the scene and property damage in excess of \$4,400. The OMC's records showed that the carrier had not reported the November accident as of January 10, 1992.

When contacted about the failure to submit an accident report within the prescribed 30 days, the motor carrier spokesperson said that the carrier had not received a police report of the incident and was unaware of any injury in the accident. The spokesperson further stated that the carrier thought he had 30 days from receipt of the accident report to file an MCS 50-T with the OMC.

In conducting research for the wheel-separation investigation, the Safety Board found that the OMC's MCS 50-T data had the following limitations:

Combined Categories - The report form combines wheel and tire defects under one heading. Blowouts appear to be reported more often than wheel separations.

Exclusionary Factors - Only carriers involved in interstate transportation are required to report accidents to OMC. Intrastate carriers (those that operate solely within the State) are not required to report accidents to OMC. In addition, carriers are not required to report accidents that do not result in injury and/or damage in excess of \$4,400. The Safety Board believes that many wheel separations may occur that do not result in accidents.

Low Compliance - When filing reports, carriers have an incentive not to report mechanical defects or other out-of-service conditions as causal to the accident because of liability and insurance concerns.

In two separate independent studies, one done in 1987 and the second in 1990, researchers found that the reporting rate for carriers filing MCS 50-T accident reports involving fatalities was only about 50 percent when compared to FARS data for the same study periods.¹⁴ In 1990, Callow Associates, Inc., compared 1988 OMC

accident data with Washington State data for 1988 and found that only 3 of 47 defect crashes reported to OMC mentioned the presence of defects.¹⁵ The Callow study concluded, "We find that 42.1 percent of the 32,920 crashes reported on the MCS 50-T file for 1988 should have reported these types of defects" (instead of the actual 2.7 percent). The OMC has recognized the shortcomings of the 50-T data file.

On July 30, 1992, the FHWA issued a Notice of Proposed Rulemaking (NPRM) that calls for a new method of reporting commercial vehicle accidents to improve accuracy and uniformity. Existing reports are to be replaced by State-required police accident reports that will be electronically transmitted to the FHWA. In addition to a form detailing the accident, a supplemental vehicle information form that contains information on the truck involved must be submitted. The Safety Board concurs with the FHWA that more accurate truck accident data are needed and hopes that future data collected will highlight wheel and tire failures separately.

OMC Inspection Violations Involving Wheels

Past Safety Board investigations, FARS data, MCS 50-T reports, and State police reports provided Safety Board investigators with the means to estimate the number of fatalities and accidents resulting from wheel separations. To determine the potential for wheel separations, analysts looked at the number of defect violations issued by the OMC as part of its commercial vehicle inspection effort under the Motor Carrier Safety Assistance Program (MCSAP).

The OMC initiated the MCSAP in 1984 to promote nationwide compliance with Federal Motor Carrier safety standards. Currently, 48 States¹⁶ participate in the MCSAP, conducting roadside truck inspections in accordance with 49 CFR, Part 3, "Parts and Accessories Necessary for Safe Operation." For the wheel-separation investigation, the OMC provided the Safety Board with computerized MCSAP violation data for the period from January 1989 through February 6, 1992.¹⁷

The MCSAP inspection data show that from 1989 through 1991, State inspection offices issued more than 2,389,835 violations, of which 45,000, or about 2 percent, were for wheel deficiencies. Table 1 charts the 1989-1991 violations as grouped by Safety Board analysts.

¹⁴Carsten, Oliver, and Leslie C. Petis, Trucks Involved in Fatal Accidents, 1984, The University of Michigan Transportation Research Institute, UMTRI-87-22, Ann Harbor, Michigan, June 1987; Abkowitz, Mark, "Availability and Wuality of Data for Assessing Heavy Truck Safety," Transportation Quarterly, 44:2, April 1990, pp. 203-230. The OMC believes that some underreporting may involve carriers not subject to reporting requirements.

¹⁵Stein, Howard S., Comparison of MOC Accident Data with Independent Data from Washington State, Callow Associates, Inc., 1990.

¹⁶Florida and South Dakota have independent safety compliance and inspection programs.

¹⁷The OMC provided computerized data for four current wheel violation codes, including wheels-general, 40 CFR 393.205; cracked or broken wheels and rims, 393.205A; elongated or out-of-round stud or bolt holes, 393.205B; missing or loose nuts or bolts, 393.205C. The data provided also included the following three discontinued codes: wheel violations-general, 396.3A1W; cracked wheel rim, 396.3A1WC; and wheel lugs, 396.3A1WL.

Violation Code	Total Number of Violations			Number of Vehicles with Violations			Number of Vehicles Out-of-Service for these Violations		
	1989	1990	*1991	1989	1990	*1991	1989	1990	*1991
General	5517	7783	8344	4722	6753	7159	934	1445	1827
Cracked	7728	11793	10706	6815	10515	9475	4004	6542	6052
Elongated	2762	7240	7162	2165	5532	5158	571	1520	1537
Nuts-stud	13472	18187	17678	10562	14856	14661	2438	3212	2958
TOTAL	29479	45003	43890	24264	37656	35453	7947	12719	12374

*1991 data received as of 2/6/92

Table 1.--Wheel violations - 1989-1991.

Of the 45,000 wheel violations issued by the OMC and the States in 1990, 12,719 required that the vehicle be placed "out-of-service."¹⁸ Missing or loose nuts or bolts accounted for 40 percent of the violations issued to trucks. Cracked or broken wheels and rims accounted for about 49 percent of the total number of cases that were put out-of-service for wheel violations.

Carrier Data

The Safety Board contacted four of the largest carriers in the United States -- Roadway, Yellow, UPS, and English -- to obtain information on their experiences with wheel separations. Three carriers indicated that they maintained limited maintenance data and that they could recall only one or two incidents involving wheel separations.

According to a spokesperson for the fourth carrier, the carrier began systematically tracking wheel-separation incidents in 1986. Currently, the carrier has 9,200 tractors, 29,000 trailers, and about 300 straight trucks in its fleet that log more than 613,400,000 miles annually.¹⁹ The carrier's linehaul fleet operates exclusively on disc wheels. About 55 percent of the company's city, or pickup and delivery, fleet operates on disc wheels and 45 percent on spoke wheels.

The carrier's records show that in the 6-year period from 1986 through 1991, the company recorded the highest number of wheel-separation cases, 67, in 1989. Since that time, the number of separations experienced by the carrier declined to 27

¹⁸The Motor Carrier Safety Act of 1984 stipulates that when a motor carrier or driver "...poses an imminent hazard to safety, the Secretary shall order that" vehicle, driver, or motor carrier to cease all or part of its operation until the hazard is abated. Violations or defects noted during a MSCAP inspection must be corrected and the carrier recertified within 15 days of the examination.

¹⁹In 1991, the FHWA estimated that combination trucks traveled 96 billion miles. The total mileage of the carrier featured in this investigation equals about 0.6 percent of the total mileage for all combination trucks.

in 1991. This represents one separation per 22.7 million vehicle miles of tractor travel. The carrier's spokesperson stated that none of the 1991 incidents involved a fatality and the overwhelming majority resulted in no property damage.

The carrier's records show that 50 percent of the separations involved drive wheels, 30 percent involved trailer wheels, and 20 percent, dollies. The carrier's fleet had no front-wheel separations during 1991. The carrier's spokesperson said the wheel problems experienced by the company occurred within 3,000 miles following maintenance that involved tire mounting. By comparison, in 1991, the company's fleet had about 17,000 flat tires, of which 12,000 occurred while the vehicles were enroute. The carrier's spokesperson said that 5,727 vehicles received Commercial Vehicle Safety Alliance (CVSA) inspections, during which examiners found 55 broken springs. Carrier maintenance personnel also found 1,834 fractured tractor springs and 297 fractured trailer springs during routine shop inspections (see Figure 15.)

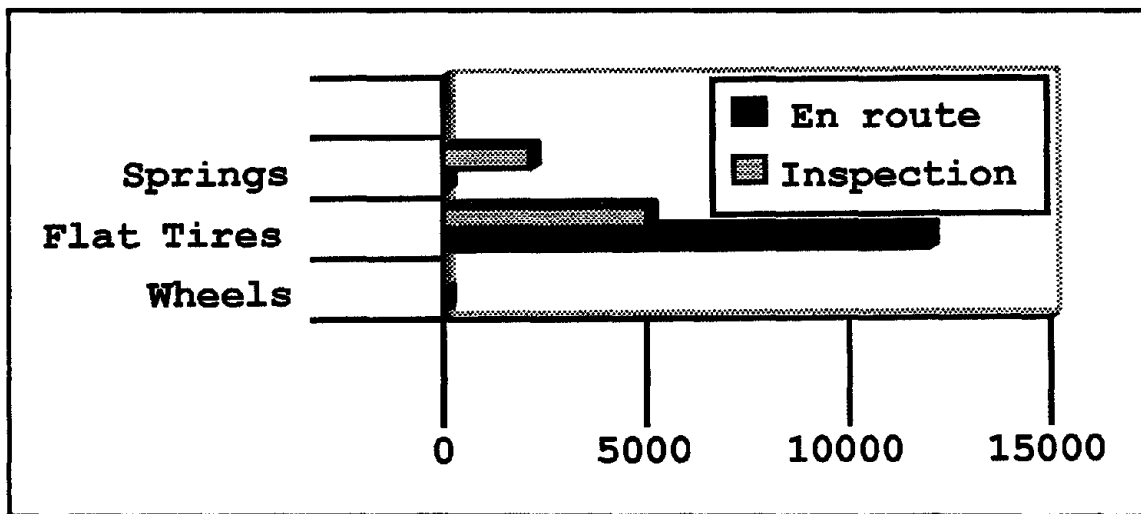

Figure 15.-- Mechanical Defects observed by carrier.

NHTSA'S Defect Investigations

One of NHTSA's major functions is to investigate potential vehicle or vehicle equipment safety-related defects related to design, construction, or performance. Section 152 of the Motor Safety Act of 1966 authorizes the agency to order a manufacturer to recall and remedy a product after NHTSA investigators have verified that the defect "poses an unreasonable risk to motor vehicle safety."

NHTSA obtains information about defects from various sources, including manufacturers, consumer groups, and private citizens. To provide an improved means for consumers to alert the agency about potential defects, NHTSA established a telephone hotline in 1978.²⁰ Since that time, NHTSA has received seven calls related to truck wheels, four for highway vehicles and three for off-road vehicles. A NHTSA spokesperson stated that the agency believes that the poor use of the hotline

²⁰The hotline number is 800-424-9393; in Washington, D.C., the number is (202) 366-0123.

by the trucking industry has resulted from a lack of industry and consumer awareness that it exists. The spokesperson noted that NHTSA will be conducting an extensive campaign to publicize the service.

A review of NHTSA's defect investigations and analyses since 1967 showed that most truck wheel separations involved older or poorly maintained vehicles and did not result from manufacturing defects. In the past 25 years, NHTSA has initiated 18 safety investigations into alleged manufacturing defects of medium/heavy trucks and trailers as a result of truck-wheel separations. Of the 18, not every defect investigation resulted in a recall.

Table 2 lists the investigation cases. In some cases, although NHTSA did not discover a safety defect, the manufacturers issued service bulletins to address maintenance issues that could result in wheel separations.

<u>Action No.</u>	<u>Mfg.</u>	<u>Model/Make</u>	<u>Year</u>	<u>Defect</u>
C 85-010	Ford	E/F 350	1975-84	Dual rear wheel retention
EA85-044	Western	Semitrailers	--	Inner cap nut failure
EA87-016	Eaton	Trailer axles	--	Failure
EA88-044	Kaper 2	Wheel covers	1980-89	Wheel separation
IR83-017	Theurer	45'Semitrailer	1980	Lost left rear wheels
IR83-051	Firestone	22x7.5 wheel	--	Failure
IR83-086	Firestone	11x24.5 steel wheels	--	Wheel failure
IR83-088	Dayton	IHC tractors	--	Wheel failure
IR84-003	Bame	Trailer	1978	Alleged wheel failure
IR84-008	Budd	24.5x8.25JL wheel	--	Wheel failure
IR84-011	Freightliner	Tractor	1981	Wheel studs
IR84-021	Western	Semitrailer	--	Wheel nut failure
IR84-044	Firestone	16.5x6.75 wheel	--	Wheels crack
IR84-072	Dayton	Modular & spoke wheel	--	Rim failure
PE85-055	Ravens	Dump trailers--all wheels	1984-85	Inner cap nut failures
PE86-019	Fruehauf	Gravel trailer	1977-85	Hub nut failures
PE87-036	Peterbilt	All Eaton or Rockwell axles	--	Rear inner wheel bearings
PE90-098	Volvo GM	Class 8 trailers	1990	Wheel separation

Table 2. NHTSA's Investigations for truck-wheel defects.

Vehicle and component manufacturers are also required to notify NHTSA of possible defects and subsequent inspection recall campaigns. The NHTSA provided the Safety Board with computerized summaries of all recall campaigns conducted since 1966. The data sheets included recall campaigns for "Vehicles--Foreign and Domestic" and "Equipment--Domestic."

After eliminating automobiles, buses, boat trailers, and other categories not related to medium/heavy trucks, Safety Board analysts determined that foreign

manufacturers had conducted 3 inspection recall campaigns, domestic equipment manufacturers had conducted 27, and domestic vehicle manufacturers had conducted 101. The following is an overview of the recall findings organized by reporting periods. Note that not all inspections resulted in vehicle or component recalls.

- 1966-1969** Inspection recall campaigns totaled 10. No vehicles were found to have defects.
- 1970-1979** Inspection recall campaigns totaled 83, of which 24 yielded no vehicles with defects. An additional 22 manufacturers' inspections found 10 or fewer vehicles with defects. Eighteen manufacturers' inspections conducted prior to 1976 found fewer than 100 vehicles with defects. Sixteen manufacturers' inspections found between 100 and 1,000 vehicles with defects. The three inspections that involved more than 1,000 vehicles were for vehicles manufactured prior to 1972.
- 1980-1989** Manufacturers' inspection recall campaigns totaled 34. Two inspections found 10 or fewer vehicles with defects. In one inspection recall campaign that Webb Wheel Products initiated to 11 vehicle manufacturers, Webb found that 2,364 1989 tractors and semitrailers had been equipped with studs made of an improper grade of steel. When heat treated, the studs failed to meet strength and hardness requirements. Four inspections involved the recall of about 100 vehicles manufactured before 1986.
- 1990-present** To date, four manufacturers have initiated truck wheel inspection/defect recall campaigns. Fruehauf found that 27 of the 1989 truck trailers were equipped with incorrect cap nuts on the vehicles' single steel wheels. The cap nuts prevented proper contact with the disc.

In 1991, Oshkosh Truck Corporation found that 42 multi-purpose and HB-series 1991 medium/heavy trucks had been equipped with studs too small to handle the maximum recommended torque on the rear-steer axles. The cyclic stresses of vehicle use and the tightening of the wheel nut would have ultimately resulted in fatigue.

On May 21, 1992, Alcoa alerted the NHTSA that certain of its forged-aluminum wide-base single truck-wheels, "super singles," could have "circumferential linear discontinuity," which "may appear as a crack," at the intersection of the disc and the rim on the shallow side of some wheels. Alcoa listed the wheel identification numbers for inclusion in the NHTSA notification campaign.

On June 22, 1992, Paccar informed the NHTSA that it was recalling 850 Kenworth and Peterbilt vehicles because Paccar had determined that certain wheel mounting studs were subject to failure "due to hydrogen embrittlement." Manufactured by Dayton-Walther, the studs had been installed on certain iron front and rear hubs that utilized a ball seat wheel mounting configuration.

Since the beginning of the Safety Board's wheel-separation investigation, the NHTSA has initiated six wheel-defect investigations. Four of the investigations involved off-the-road trucks.

On July 10, 1992, the NHTSA informed the FHWA that based on information provided by an individual consumer, the NHTSA was opening a preliminary evaluation to determine the safety ramifications of cracked nuts allegedly manufactured by Motor Wheel. Motor Wheel plans to test the nuts to determine whether they are counterfeit and when they were manufactured.

On July 21, 1992, the NHTSA advised the Safety Board that it was also conducting tests on a certain type of Mack/Renault truck bearings.

On July 27, 1992, the North Carolina Division of Motor Vehicles Enforcement Section notified the NHTSA that in the course of examining a carrier's 1992 Kenworth tractor, its personnel identified what appeared to be a compatibility problem between the spindle threads and the retaining nut. The NHTSA is currently evaluating the claim.

Other Independent Studies

In the course of its research for the wheel-separation investigation, the Safety Board became aware of a similar, highly publicized wheel study conducted in the United Kingdom (UK). Safety Board analysts obtained copies of it and reviewed the UK findings. The Safety Board found that key factors identified, such as road design, turning requirements, average travel distance, vehicle and wheel design, manufacturing standards, and load configurations, differed so greatly from U.S. standards that they had little relevance to this analysis.

An independent study of the OMC's MCS 50-T data files, published by the Urban Institute in 1991,²¹ identified seven defect categories associated with the highest societal costs for the period from 1984 through 1988. In order of decreasing cost, the categories were brakes (\$199,040,376), wheels/tires (\$189,951,382), the fuel system (\$89,832,313), the engine, steering, lights, and the driveline.

The Urban Institute's analysts used data from the FHWA's 1988 SAFETYNET to compute relative risk ratios describing the comparative cost risks of different defects. In 1988, motor carrier violations issued for wheels and tires totaled 32,799. Excluding "other" violations (about 20 percent of all violations), wheel/tire violations accounted for 15.2 percent of all violations issued to medium/heavy trucks, surpassed only by brakes (115,795) and lights (38,872).

The institute's analysts developed cost-efficiency ratios to show how resources were allocated among crash types by defects. In their report, they stated, "Whether the goal is crash cost minimization or crash minimization, our analyses suggest that wheels/tires and the suspension system require more roadside inspection time than they received in 1988." Typically, wheels and tires ranked first, second, or third in all analyses that determined a relative effectiveness for inspection of the more common

²¹Douglas, John B. and T.R. Miller, "The Relative Efficiency of Out-of-service Criteria as Accident Deterrants", The Urban Institute, July 30, 1991.

analyses that determined a relative effectiveness for inspection of the more common vehicle defects. The institute's study determined that the time devoted to a vehicle's inspection averaged 20 minutes, of which 2 minutes were spent on wheels and tires. The Urban Institute study called on the OMC to place additional emphasis on inspections of tires and wheels.

Safety Board analysts determined from screening the FARS and OMC data that most failures reported as wheels/tires accidents are tire blowouts. The Safety Board therefore believes that before the OMC alters its recommended inspection procedures, the States need to separate tire blowout accidents from wheel-separation accidents in their data collection efforts, especially if the OMC terminates the 50-T data collection. This would provide policymakers with the information necessary for determining whether more emphasis should be placed on tire inspection or on wheel conditions.

Accident Data Summary

National statistics for 1989 compiled by the NHTSA indicate that compared to the total number of medium/heavy truck crashes²² (349,000), the number of wheel-separation accidents was small, about 750 to 1,050, or about 0.3 percent.²³ NHTSA statistics also show that medium/heavy trucks involved in fatal accidents for 1989 totaled 4,960. Police reports identified 418 of the total fatal accidents, or 8.4 percent, as involving truck vehicle defects. Fatal wheel-separation accidents represented about 2 percent of all fatal truck accidents involving reported defects.

The MCSAP inspection statistics show that wheel violations represent only 2 percent of the violations. In 1990, the FHWA reported that, excluding two-axle, four-tire trucks, licensed medium/heavy trucks totaled about 5,827,000.²⁴ Based on 44,000 vehicles that had violations, Safety Board analysts computed that 0.64 percent of the licensed medium/heavy trucks were inspected and found to have wheel violations. Only about 0.22 percent of the registered trucks are placed out-of-service for wheel violations.

The Safety Board believes that the number of wheel separations from trucks is small compared to the total number of truck accidents and to the other types of deficiencies involved in truck accidents. Roadside inspections result in relatively few wheel deficiency violations compared to other truck deficiencies, such as brake deficiencies. However, the tragic consequences of the 1991 wheel-separation fatalities and the lethal potential of wheel-failure separations cannot be dismissed, and that further safety countermeasures, as defined in this report, should be explored.

²²Events that produce injury and/or damage, involve a motor vehicle in transport, and occur on a trafficway or while a vehicle is still in motor after running off the trafficway.

²³Summary of Medium & Heavy Truck Crashes in 1989, USDOT, NHTSA, DOT HS 807 739, July 1991.

²⁴Selected Highway Statistics and Charts 1990, USDOT-FHWA.

SECTION 4

WHEEL SEPARATION CAUSES AND POTENTIAL SOLUTIONS

Accident Causes

The Safety Board found that no one data source was sufficient to enable it to determine the leading causes of wheel separations. The FARS data sample was small and often inconclusive. Most State police report forms did not categorize tire and wheel defects separately. The OMC data obtained for this report were a small sample covering the OMC's Region 4. Five of the six States queried by the Safety Board provided computer statistics from which the cause of wheel separations could not be determined. Only one of the four major carriers queried kept wheel separation maintenance records on its fleet.

Despite the lack of comprehensive data, the Safety Board found that the databases examined show similar patterns and, in combination, enabled it to identify the most probable causes of wheel separation. The Safety Board believes that the most common causes of truck-wheel separations are the loss or breakage of wheel fasteners and wheel bearing failure. Both result from improper maintenance.

Case Findings

Fatal Accidents.--Of the reports filed for the 24 fatal accidents occurring from 1989 through 1991, 11 contained sufficient information to determine the cause of accident. Of these 11, 7 fatal accidents resulted from loose nuts that sheared the studs, which, in turn, damaged the threads. Three fatal accidents involved bearing failures.

OMC's Region 4 Survey.--Analysis of data for the 38 wheel-separation cases in the OMC's Region 4 showed that 18 wheel separations resulted from broken studs, lugs, or loose nuts, and another 18 from bearing failures.

Six-State Survey.--Of the six States that the Safety Board surveyed, only South Dakota provided copies of the police reports on wheel separations investigated in the State. South Dakota's data included 15 wheel separation accidents; 4 accident reports highlighted the cause of separation. Two accidents resulted from broken studs and two from bearing failure.

In total, the Safety Board accumulated data on 53 cases that contained sufficient information to enable it to determine the probable cause of the truck wheel separations (see figure 16).

Maintenance Deficiencies Identified

Wheel failures involving broken studs, lugs, or loose nuts most frequently result from the improper tightening of the nuts or failure to retighten the nuts after the initial seating of the fasteners. The Safety Board identified undertightening as the causal factor in both the Warrior, Alabama, and Marion, North Carolina, fatal accident investigations. Improper tightening procedures are also thought to have caused the Sunflower, Mississippi, accident.

Broken studs, lugs, or loose nuts	-	27
Bearing failure	-	23
Spare tire unsecured	-	2
Disc failure	-	1

Figure 16.--Leading causes of wheel separations 1989-1991.

Wheel failures resulting from seized bearings also stem primarily from improper maintenance. In trucks requiring grease, bearing seizure can usually be attributed to lack of lubrication. Overloading a vehicle and installing the axle nut using either too much or too little torque can also cause bearing failure. The Safety Board identified bearing failure as the causal factor in both the Miami, Florida, and Greensboro, North Carolina, fatal accident investigations.

Other Support Documentation

In addition to the accident cases noted above, OMC violation data and maintenance records provided by one of the nation's largest carriers support the Safety Board's findings that the undertightening of fasteners results in most wheel separations.

The carrier's maintenance records showed that wheel separations in the company's fleet resulted from the following causes: undertightening, 65 percent; overtightening, 20 percent; bearings, 1 percent; all other causes, including improper assembly, 14 percent. The carrier's low percentage of bearing failures can probably be attributed to the fact that most trucks in its fleet have oil-lubricated rather than grease-lubricated bearings. The carrier's records also reflect higher quality control in bearing maintenance.

The OMC's MCSAP data show that in commercial vehicle inspections conducted by the States, 40 percent of all wheel violations issued were for loose or missing nuts or studs. Stud hole elongation, which results when fasteners are loose during wheel use, was the third leading violation.

Examination of Current Maintenance Practices

The Safety Board looked at numerous industry publications, surveys, and maintenance manuals to determine possible reasons for truck-wheel maintenance problems. The Safety Board found that maintenance problems appear to stem from several causes; the two major ones are failure by maintenance personnel to follow recommended procedures and lack of uniformity in carrier and/or manufacturer's maintenance guidelines.

Improper Tightening and Noncompliance With Recommended Procedures

Numerous sources identified the failure to follow proper maintenance practices as a major cause of improper tightening of wheel fasteners. The OMC surveyed 16 carriers who performed their own wheel maintenance and found that 9 admitted to not following manufacturers' procedures.

Several manufacturers stated that when they performed metallurgical analyses on failed studs, they determined the failures were caused by fatigue that most likely resulted from improper tightening of wheel nuts by service facilities.

In an October 16, 1990, letter from Volvo to fleet service managers throughout the country, the company's Manager of Product Liability expressed concern over increased wheel stud failures among its medium/heavy trucks. The Volvo manager cited "...inadequate maintenance of wheel assemblies." Volvo identified the following improper procedures:

Service personnel failed to use a properly calibrated torque wrench to ensure proper clamping force.

On rear wheel assemblies, service personnel tightened only the outer wheel nuts; in most cases, with an air impact gun. Proper torquing procedure calls for the technician to loosen the outer nut, torque the inner cap nut, and then torque the outer nut.

Owners failed to check wheel nut torque on new vehicles until the first preventative maintenance service at 25,000 miles. Proper procedure requires wheel nut torque to be checked after the first 100 miles of operation.

Truck and Wheel Manufacturers' Guidelines

To determine what guidance was available to installers, the Safety Board reviewed several truck and wheel manufacturers' manuals (see appendix E), including the National Wheel & Rim Association's manual,²⁵ which contains safety information, operating procedures, and wheel and rim maintenance information for 12 of the nation's leading wheel manufacturers. The maintenance manuals reviewed indicate that deficiencies in the following areas can affect the tightness of fasteners:

Initial Inspection.--Most manufacturers recommend a wheel inspection after a new vehicle's first 50- to 100-mile trip; they also recommend a 50- to 100-mile inspection after any maintenance that involves removing the wheels. One wheel manufacturer calls for the initial inspection within the first 500 miles. During the initial trip and the first trip following the mounting of a new wheel, parts seat and nuts become loose. After the initial check, manufacturers differ on how frequently wheels should be inspected. Manufacturers' reviews indicated that carriers often do not tighten fasteners after seating occurs.

²⁵"Wheel & Rim Manual," National Wheel & Rim Association, Form W-770, 1992 Issue, September 1991. The manual contains recommended procedures for Accuride, Alcoa, Budd, Dayton Walther, Erie, Firestone, Goodyear/Motor Wheel, Gunitite, Kelsey-Hayes, Redco, and Webb.

Tightening Pattern.--Nuts on spoke and disc wheels must be tightened in a crisscross pattern. These patterns vary slightly depending on the number of bolts and other design features in the wheels. All manufacturers recommend that service personnel consult the appropriate manuals before tightening the nuts. Manufacturers also recommend that service personnel initially tighten the nuts using a hand wrench until the nuts are snug and then, following the same crisscross pattern, use a torque wrench to tighten the nuts to the desired torque.

Recommended Torque.--Hub, stud, and spoke wheel manufacturers frequently have different torquing requirements and, as a result, most manuals have an advisory statement to consult wheel field service representatives if torquing requirements conflict. Appendix F contains a table of recommended torques from wheel and rim manuals provided for this special investigation. The table shows that large disc wheels generally require from 400 to 550 ft-lb of torque; maximum torque varies between 500 and 550 ft-lb.

Some special wheels require unusually low or high torques. Smaller fasteners on some spoke wheels can require torques as low as 175 ft-lb, while fasteners on duplex wheels with heavy-duty mounting can require as much as 800 ft-lb. Some manufacturers provide labels on trucks to indicate the proper torque. (See sample sticker in figure 17.) Webb, Budd, and Volvo also provided the Safety Board with



 DAYTON WALTHER <small>A DIVISION OF VALTYP CORPORATION</small>		TORQUE SPECIFICATIONS WHEELS		DAYTON WALTHER CORP. 2800 EAST RIVER RD. DAYTON, OHIO 45439 (513) 296-3191										
(1) INSTALL RIM CLAMPS AND HAND TIGHTEN RIM NUTS. (2) TIGHTEN THE #1 RIM NUT AT THE TOP OF THE WHEEL TO 50 FT-LBS. ROTATE THE WHEEL AND RIM ASSEMBLY UNTIL THE #2 RIM NUT IS IN THE #1 POSITION AND TIGHTEN TO APPROXIMATELY 50 FT-LBS. CONTINUE THIS PROCEDURE UNTIL ALL RIM NUTS HAVE BEEN TIGHTENED TO APPROXIMATELY 50 FT-LBS OF TORQUE. (3) NOW REPEAT THE ABOVE PROCEDURE RETIGHTENING THE RIM NUTS IN THE SAME ORDER AT 50 FT-LB INCREMENTS TO THE RECOMMENDED TORQUES SHOWN IN THE TABLE BELOW.			IMPORTANT DO NOT OVER TORQUE !! OVER TORQUE CAN DEFORM RIM, SPACER, RIM CLAMP, AND RIM STUD. MONITOR RIM NUT TORQUE AFTER THE FIRST 50-100 MILES AND DURING ALL MAINTENANCE CHECKS.											
<table border="1"> <thead> <tr> <th>3/4" STUD TYPES</th> <th>FRONT</th> <th>REAR</th> </tr> </thead> <tbody> <tr> <td>CAD PLATED STUDS</td> <td>225-250</td> <td>200-250</td> </tr> <tr> <td>PHOS & OIL COATED STUDS</td> <td>175-190</td> <td>175-190</td> </tr> </tbody> </table>		3/4" STUD TYPES	FRONT	REAR	CAD PLATED STUDS	225-250	200-250	PHOS & OIL COATED STUDS	175-190	175-190			GAP PERMISSIBLE BUT NOT REQUIRED IF GAP EXCEEDS 1/4" OR IF CLAMP BOTTOMS OUT BEFORE REACHING 80% OF RECOMMENDED TORQUE, CHECK TO INSURE THAT PROPER RIM CLAMP AND SPACER COMBINATION IS USED.	
3/4" STUD TYPES	FRONT	REAR												
CAD PLATED STUDS	225-250	200-250												
PHOS & OIL COATED STUDS	175-190	175-190												
														

Figure 17.--Photocopy of a specification label provided by a leading wheel manufacturer. Actual Sticker measures 4 inches x 10 inches.

copies of labels that they provide with their trucks. Other manufacturers, such as Alcoa, stamp nuts that require a special torque.

During the technical review of this special investigation report that was conducted with government and industry representatives, the Truck Trailers Manufacturers Association informed the Safety Board that all their manufacturers were placing labels on trailers. Most of the participants at the technical review contended that labels were beneficial because mechanics may not always refer to manuals. The Safety Board agrees that labels provide a good quick reference to or

reminder of the torque required, the sequence for tightening nuts, and the need to periodically retighten fasteners. The Safety Board believes that all manufacturers should consider providing labels to place on trucks near the wheels.

Compatible Hardware--Manufacturers' manuals and supplemental literature warn mechanics to use only the same type and style of wheels and mounting hardware when replacing original equipment parts and to avoid nonstandard parts. Many wheel components appear similar but are not exactly the same and will not result in proper mating surfaces. For example, manufacturers caution not to mix ball-seat wheels or fasteners with flange nut wheels or fasteners. Aluminum wheel manufacturers warn mechanics not to change from aluminum wheels to steel wheels, or vice versa, without changing the mounting hardware. Manufacturers advise changing the flange nut-mounting systems when changing the hub and stud assembly. Manufacturers warn mechanics to use the proper type and size of nuts when mounting the rim/wheel on the vehicle.

A January 4, 1989, wheel-separation accident investigated by the California Highway Patrol is an example of what can occur when mechanics use incompatible components. During maintenance on the 1973 Peterbilt tractor shortly before the accident, service personnel had switched from steel to aluminum wheels but failed to use the longer studs required with aluminum wheels. With the shorter studs, the nuts did not have enough thread contact on the studs. While the tractor was southbound on Interstate 5 near Encinitas, one of its wheels separated and crossed the median into the path of northbound traffic. The wheel struck three northbound vehicles and continued to roll to the east side of the road, where it struck and killed a person who was on the shoulder, working on his automobile. Accident investigators found that all of the nuts were loose and 8 of the 10 studs on the accident vehicle had sheared.

Contamination of Mating Surface--Excess dirt, metal burrs, rust, and paint on wheel stud hole perimeters can cause wheel mounting nuts to loosen with use and result in premature separation. In its investigation of the two wheel-separation fatal accidents that were caused by loose fasteners, the Safety Board found paint and/or rust build-up, as well as metal build-up.

Virtually all service manuals caution that wheel mounting areas must be kept free of paint runs, paint build-up, and other debris. The Volvo manual advises that "check-tightening is particularly important when rims or brake drums are newly painted. Paint can flake off these surfaces and cause the nuts to lose their torque and the wheel to loosen up." Manuals also advise that stud hole chamfers should not be allowed to accumulate excessive paint build-up.

Manufacturers also recommend that mechanics be certain that paint is thoroughly cured before installing wheels on vehicles. Independent studies have found that dirt in the interfaces or a breakdown of paint films can result in a loss of clamping forces in excess of 60 percent after extended running without retightening.

The area where personnel work on the wheel or mount the wheel on the truck should be clean and free of dirt to reduce the chances of contamination where the nut and the wheel mounting surface meet. The Navistar service manual cautions technicians to keep stud threads clean to ensure correct torque, suggesting that they use a wire brush at the base of each stud. It also advises service personnel to keep the hub or drum where the wheels contact clean and flat.

Manufacturers warn that wheels changed along a highway while en route can be contaminated if allowed to touch the ground. The manuals state that drivers should take precautions to ensure mating surfaces are clean when field mounting is necessary. In addition, air impact wrenches, rather than torque wrenches, are usually used in the field. The Safety Board believes that carriers may need policies requiring that field-mounted wheels be inspected as soon as the vehicle returns to a maintenance facility.

Manufacturers also point out that service technicians should take extra precautions to keep mating surfaces clean, smooth, and free of lubrication when assembling wheels. While some two-piece nuts require a drop of oil between the nut and the washer, manufacturers believe lubrication of wheel fasteners should be avoided unless there is strict shop control to ensure that mating surfaces are free of lubrication.

Overtightening

Another potential cause of wheel separations resulting from noncompliance with recommended maintenance practices is overtightening of nuts. A spokesperson for a large carrier stated that 20 percent of the carrier's wheel failures resulted from overtightening. The Safety Board examined some nuts that may have failed in this way; manufacturers stated that they have seen numerous occasions of overtightening using air impact wrenches. Some air wrenches can deliver almost three times the required torque.

The air impact wrench is used extensively to mount wheels because of its utility and speed. Wheel manuals warn that mechanics must avoid over- or undertightening; overtightening can overstress studs and damage threads. The torque that air impact wrenches deliver depends on the air line pressure from which they operate. If the pressure is low, the torque may be low. Similarly, if the pressure is high, the torque may be high. The amount of water or particulates in the air can also affect the torque and performance of the wrench. In addition, the performance of the tool depends on how much service it has performed since its last calibration, the power of its motor (which can change with the amount of lubrication provided), and the ability of the mechanic to use the tool properly.

The Safety Board believes that if an air impact wrench is used, at minimum, a torque limiting valve, a dryer, an accumulator, and regulated pressure should be used with it. If torque wrenches are not used all the time, as manufacturers recommend, periodic checks with a manual torque wrench should be made to ensure accuracy of the air impact wrenches. An air wrench calibrated at 500 ft-lb will twist smaller studs on some spoke wheels, such as Gunit Corporation's, and distort the rim spacers during initial installation. Wrench output must be checked or calibrated at regular intervals. A torque wrench can be used to check the air wrench output and help adjust the regulated line pressure, as necessary, to ensure correct torque. The Safety Board believes that the industry needs to utilize torque wrenches more and air impact wrenches less.

To correct torquing problems, carriers use different approaches. One carrier has installed monitoring devices with warning buzzers to alert mechanics that shop line air pressure is too low. Another carrier has developed a cart for use in changing wheels. The cart is equipped with regulators for line pressure and a torque-limited

air impact wrench. In response to carrier requests, one tool manufacturer has developed a torque-limited air impact wrench to reduce the problem of overtightening on some types of wheels. The torque limiter is factory-set to be within manufacturer's specifications of 500 ft-lb within approximately a 5-second impacting time. The 500 ft-lb is maintained with line pressures between 90 and 170 psi. The wrench still has a reverse full-power ultimate torque of 1,400 ft-lb at a line pressure of 90 psi. Carriers and service areas need to determine whether new procedures, training, equipment, or accessories are needed to ensure proper torque.

In summary, the Safety Board believes that to reduce the incidence of wheel separations due to noncompliance with existing guidelines, maintenance facilities must make every effort to ensure that mechanics have the necessary manuals and torque wrenches and follow recommended truck wheel installation and tightening procedures. Too much or too little torque can result in wheel separations. Manufacturers should provide quick-reference information on the recommended torque. Proper parts must be available, and the mixing of components must be avoided. Surfaces must be kept clean from rust, metal burrs, lubrication, and paint build-up. Wheels must be rechecked for torque after any trip during which fastener seating might occur, including a vehicle's initial trip or any trip following subsequent wheel maintenance that would allow seating of the fasteners.

Inadequate Inspection Guidelines

The Safety Board found that time and distance between maintenance and inspection requirements differ greatly among manufacturers, particularly with respect to inspection frequency for truck wheels, as shown below:

Goodyear/ Motor Wheel	"Parts will seat naturally and torque on nuts will drop. Maintain torque levels at the recommended values through planned periodic checks...."
Dayton	"Torque on all nuts should be checked every 2,000 to 4,000 miles and during regular maintenance checks before trips."
Gunite	"...rim clamp nuts on spoke wheels should be checked once a week (these wheels use lower torques)."
Kelsey	"Check torque on all stud nuts once each week (these spoke wheels use lower torque)."
Webb	"...for ball seat mounted disc wheels and pilot mounted disc wheels, check capnut torque every 2000 - 4000 miles."
Budd	"Do a torque check when you are doing scheduled maintenance on the vehicle, or at 10,000 mile intervals, whichever comes first."
Navistar	"Inspect and retorque stud nuts for spoke and disc wheels once each week."

Volvo "Tighten all wheel nuts after 50-100 miles and at intervals not longer than every 6 months."

The Safety Board interviewed several motor carriers and found that recommended inspection frequency varied greatly among them. For example, a spokesperson for the carrier involved in the Warrior, Alabama, accident, reported that it conducts a visual safety lane inspection every time a tractor/semitrailer enters a terminal for service, including fueling. Any defects or inspections due are written up and forwarded to the proper repair shop. The spokesman said that the company's fleet undergoes a series of routine vehicle inspections beginning at 5,000 miles. The company's trailers are "L" inspected every 15 to 30 days and "A" inspected once a year. The "L" inspection includes lubrication, oil and grease, as well as a visual inspection. During an "A" inspection, engines or brakes are examined and overhauled or rebuilt, as necessary. In the course of an "A" inspection, service personnel may have to remove the wheels to perform requisite brake maintenance. After servicing the brakes, they must remount the wheels, which involves retorquing the wheel fasteners. The trailer involved in the Alabama accident had received an "L" inspection (visual) 3 days before the separation occurred.

Another carrier's spokesperson indicated that his company monitors all tractor and trailer units for obvious problems by performing a safety lane check each time the vehicles are refueled, approximately every 500 to 700 miles. Trailers receive a visual in-shop inspection every 2,500 to 3,000 miles. Tractors receive a detailed inspection every 25,000 miles as part of the carrier's periodic preventive maintenance program. The carrier also conducts an additional in-depth examination of its tractors and trailers as part of the company's annual inspection program. The carrier's spokesperson said if a wheel problem develops, it generally occurs within 3,000 miles following tire mounting.

As part of the investigations of the Warrior, Alabama, and Marion, North Carolina, wheel-separation accidents, which resulted from loose fasteners, Safety Board examiners talked to carrier representatives and looked at the companies' maintenance records. Safety Board analysts found that the Alabama carrier required that vehicles be examined visually, but did not require that nuts be routinely retorqued unless the service technician observed rust or other potential problems. After the accident, almost all of the carrier's combination vehicles were retorqued. The carrier found that due to the poor chamfer conditions on the wheels, the torque was not being maintained and older nuts often would not seat properly. During the inspections, wheels and nuts were replaced that would not torque properly. The carrier's current policy requires torquing after the removal of wheels and at 60-day intervals. All wheels that show rust streaks are disassembled and inspected. No problems have occurred since the initial examination.

The truck involved in the Marion, North Carolina, wheel-separation accident had traveled 58,000 miles since the carrier last performed work on the axle. Maintenance records did not reflect and analysts could not determine whether the wheel fasteners had been retorqued after the painted wheels were reassembled.

The Safety Board believes that if the vehicle wheels had been properly inspected and maintained to an established industry standard, the wheel separations probably would not have occurred at Warrior, Alabama, and Marion, North Carolina.

The MCSAP inspection findings also support the Safety Board's belief that the trucking industry needs to standardize the requirements for torquing wheel fasteners and that carriers need to adopt aggressive maintenance programs that adhere to these standards. Because MCSAP data show that annual State roadside inspections identify more than 40,000 vehicles with loose or missing wheel fasteners, wheels appear to be a candidate for extra attention. Thus, the Safety Board believes that truck wheel manufacturers and motor carriers need to work together to develop more specific guidelines for maintenance intervals, perhaps based on type of operation and age of equipment.

Replacement Practices for Broken Wheel Studs

A stud tends to break after several fasteners become loose and the stud has developed fatigue cracks. If one stud breaks, the studs on each side of it were probably loose, stressed, and fatigued. If more than one stud breaks, most of the studs were probably loose, fatigued, and susceptible to failure in subsequent use. Most truck wheel manufacturers recommend that if one stud breaks, the studs on each side of it should be replaced. If two or three studs break, some manufacturers recommend that all bolts be replaced. The survey in appendix G lists the manufacturers' recommendations found in wheel and rim service manuals. In most cases, if one stud breaks, these recommendations are similar; if more than one stud breaks, the recommendations vary greatly, from replacing the broken stud to replacing all of the studs. In some cases, the manufacturers indicated that service facilities were replacing only the broken wheel stud rather than following the wheel equipment manufacturer's recommended procedures.

Industry has not adopted standard guidelines for replacing broken wheel studs. An industry task force needs to develop a policy for replacement when more than one or two wheel studs break. This policy should be incorporated in future revisions of wheel maintenance manuals.

In summary, the Safety Board believes that to reduce wheel separations due to improper tightening, the American Trucking Associations (ATA), in conjunction with wheel and truck manufacturers, needs to develop model guidelines that address all of the above areas. The guidelines should be included in future revisions of manufacturers' manuals and should be disseminated to all involved in heavy-truck maintenance. The model guidelines need to address those maintenance procedures that are often not followed by mechanics, as well as uniform procedures on matters where conflict currently exists. Once these guidelines are available, the industry should launch an intensive training effort through manufacturers, carriers, the news media, truck stops, and repair facilities to highlight the need to follow recommended practices for mounting wheels.

Wheel Bearing Failures

The limited accident data available from many sources indicate that bearing failures are another leading factor in wheel separations. Two of the five cases investigated by the Safety Board involved bearing failures in which the bearings were lubricated with grease. One of the seven cases in the FARS data that identified reasons for wheel separation involved bearings. Eighteen of the 38 truck cases reported to the OMC appeared to have involved bearing failure. Most of the bearing failures were on vehicles that were 4 or more years old. In five of the OMC

bearing cases, work had been performed on the wheel in the past month, indicating that the vehicle was probably improperly serviced.

Wheel bearing manufacturers indicate that improper adjustment is the most frequent cause of bearing failure/wheel separation. The industry uses different types of wheel bearing adjustment components, and adjustment procedures also differ. Use of the correct procedure for the components involved is essential. Due to the high temperatures generated during a bearing failure, the lubricant will be destroyed by the heat, and as a result, the bearing and axle nut components often become welded together. When this fusion occurs, the axle nut is forced to rotate, causing the threads of both the nut and the spindle to shear, allowing the wheel to separate. Determining whether a bearing failure is caused by improper adjustment or inadequate lubrication is difficult, if not impossible. To determine pre-failure conditions, investigators often examine the other wheels on the vehicle.

Manufacturers and carriers indicated to the Safety Board that fewer wheel separations occur due to bearing failures now that most bearings on large truck wheels are lubricated with oil instead of grease; the oil is visible and also leaks. Still, most single-unit trucks are built with grease bearings on the front wheel. While seal material and grease have been improved, such vehicles still require periodic maintenance and monitoring. During routine maintenance inspections, determining whether a greased bearing is dry is difficult without disassembling the hub. Carriers indicated that if an oil seal leaks, a visible spray pattern is usually easy to detect and corrections are made. In addition, for oil-lubricated bearings, it is easier to check oil levels in the viewing glass of the hub. However, some engineers warned that the tendency to place covers on wheels eliminates the opportunity to frequently check oil levels, as well as the nut torque and rust streaks, and should therefore be discouraged.

One manufacturer recommends that the oil be changed every 25,000 miles and checked for metal flakes or that the seals and oil be serviced whenever the wheel is serviced or the hub assembly removed. Another manufacturer recommends that the bearings be checked every 40,000 miles or once a year. A few manufacturers call for bearings to be checked when the wheel is pulled. Wheels will be pulled less frequently in the future because most carriers are specifying outboard-mounted brake drums, which do not require that the wheel be pulled to change the brakes. The Safety Board concludes that there is no uniform interval for how often bearings or lubrication should be checked.

Because wheel bearing failures apparently are a cause of truck wheel separations, an industry-wide practice for maintaining bearings properly is needed. Bearing manufacturers have developed manuals on bearing inspections. The Maintenance Council of the ATA sponsored a Wheel End Assemblies Task Force, which developed a "Recommended Practice" for the installation of wheels and wheel bearings and for axle nut adjustment. This practice covers assembly of the bearings on the spindle and tightening of the wheel nuts(s) to obtain the proper bearing end play. It calls for bearing adjustment of smaller tolerances that should help reduce some problems associated with overly loose axle nuts. The Recommended Practice, which was distributed to ATA's membership for final approval by September 1992, does not address intervals for checking bearings or lubrication. The Safety Board believes that ATA should also develop guidelines on bearing inspection intervals.

Maintenance officials must discourage maintenance practices that could create bearing problems. During the Safety Board truck-wheel separation investigation, NHTSA officials were shown a wheel assembly that had worn out two sets of bearings and could have resulted in a wheel separation (see figure 18). NHTSA is

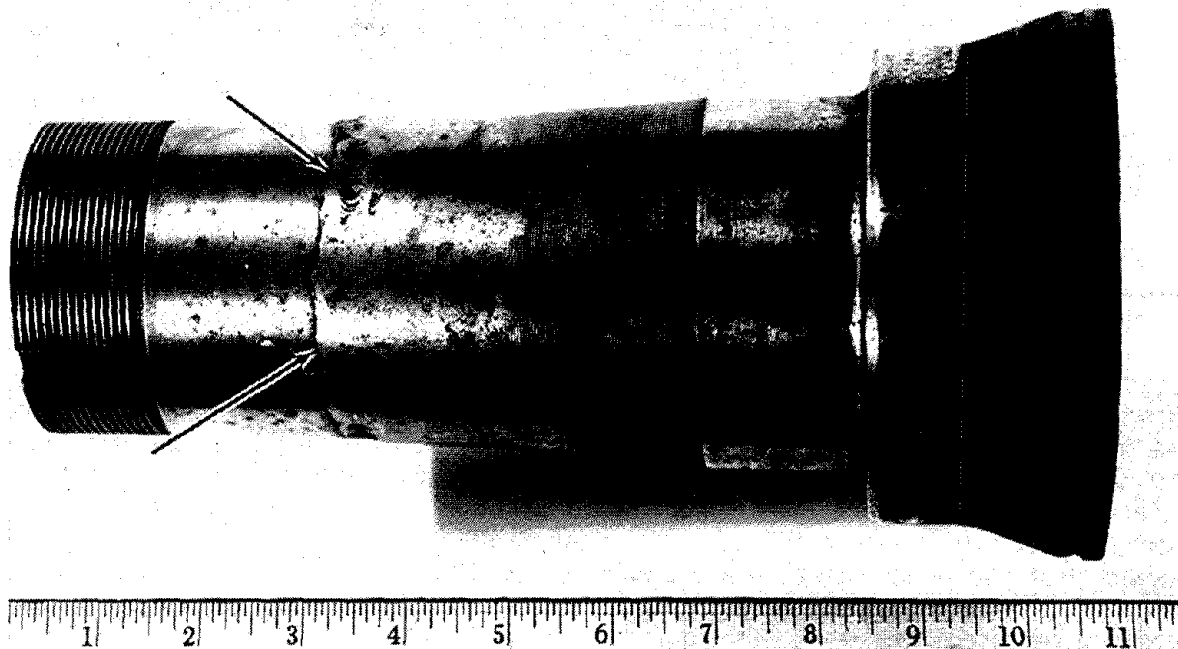

Figure 18.--An improper spindle repair. Arrow highlights the weld.

examining a remanufacturer's process to restore a spindle that was damaged due to bearing failure. The process involves cutting off the damaged part of the spindle and placing part of a manufactured spindle repair kit on the end between the bearing races, using a jig, and welding the new part on. If the welds are not correct, eccentricity or offset can be introduced that wear bearings out prematurely. When put in a lathe, the spindle appeared to be out of plumb by as much as 0.25 inch. The ATA has put out warnings against using this practice.

The CFR currently contains no specific wheel violation codes for bearing problems or for wheel lubrication leaks that would help in assessing trends. Determining whether a vehicle has a bearing problem can be difficult. While inspectors can look for leaks, evidence of leaks is not always readily visible. In one of the bearing failure cases reviewed for this investigation, the truck had been inspected 2 days before the accident. The truck had a leaky seal, and oily dirt had built up in the brake drum behind the brake shoes. The major responsibility for reducing this type of problem rests with the companies or carriers, which must ensure proper maintenance and operation. Vehicles must not be overloaded. If a bearing is installed and maintained properly and the axle is not overloaded, bearing problems should be minimized.

Wheel separations due to bearing problems do not generally appear to involve the design or manufacture of the bearings. Since the 1970s, only two

manufacturers' quality assurance campaigns have involved more than 100 vehicles with bearing problems, and both of these occurred in the late 1970s. Improvements to reduce the incidence of failures must come in the maintenance and operation area. Lubricants, such as synthetic grease, are improving, and oil lubrication of bearings has apparently helped reduce the incidence of dry bearings. Some large carriers are re-evaluating greased bearings as advances are made in these areas.

Disc Failures

Disc failures are another potential cause of wheel separations. Manufacturers indicate that the two most common causes of disc wheel failures are loose studs and excess cargo weight. The OMC inspection data indicate that more vehicles are put out of service for cracks in the wheel than for any other wheel violation and that wheel crack violations are the second most cited violations overall. The fatal accident data included a case of a disc wheel that fractured along the bolt holes, came off the truck, and struck a pedestrian. Many of the cracks in wheels are visible and are observed during inspections. If wheels have a tendency to crack, they are detected by the NHTSA or the manufacturers, as was highlighted in seven recalls. Disc failures appear to be a relatively infrequent problem compared to proper tightening and wheel bearing failures.

SECTION 5

FEDERAL AND STATE OVERSIGHT

Existing Regulations

Based on the relatively small incidence of truck-wheel separations, the Safety Board believes that existing Federal regulations for wheel manufacturers appear to be sufficient and no further regulatory effort is warranted.

Defect Identification Effort

Analysis of available accident data shows that no one problem is limited to a specific manufacturer. Thus, the data seem to support the finding that wheel separations are not the result of a design defect. The Safety Board found that wheel separation accidents typically involve older vehicles and result from improper maintenance. This investigation also revealed that the trucking industry underuses NHTSA's toll-free Auto Safety Hotline. From 1978 to 1991, NHTSA received only four complaints about truck wheel defects through the hotline.

According to NHTSA representatives, the agency recognizes the need to improve the use of the Auto Safety Hotline and is currently printing 5,000 flyers promoting the hotline for distribution to manufacturers and carriers within the trucking industry. The NHTSA is also working with the ATA to encourage more reporting of alleged truck defects. The Safety Board believes that the NHTSA should continue its efforts to inform the trucking industry about the Auto Safety Hotline, which would aid in the identification of potential design problems.

Current OMC and State Inspection Efforts

Research shows that OMC and State inspection efforts have aided in the identification of medium/heavy truck wheel deficiencies and reduction of potential wheel-separation accidents. The Safety Board estimates that during 1991, wheel-separation accidents nationwide totaled between 750 and 1,050. During the same period, the OMC and the States issued more than 44,000 violations to truck companies and operators for wheel defects found during Federal and State inspections. States with and without Federally approved MCSAPs have assisted in the OMC inspection effort. During its in-depth investigation of the five fatal truck-wheel accidents in 1991, the Safety Board evaluated the respective inspection programs of the States in which the accidents occurred or where the accident vehicle was domiciled. The following are summaries of the Safety Board's findings:

Mississippi - The Mississippi Public Service Commission operates the State's MCSAP. The commission has 27 inspectors assigned to its motor carrier safety unit; 6 are dedicated to safety reviews. In 1991, the unit performed 18,500 inspections resulting in 6,192 commercial vehicles being placed out-of-service.

Alabama - The State of Alabama Department of Public Safety Motor Carrier Division adopted the Federal Motor Carrier Safety Regulations (FMSCR) in June 1986. The State has 42 uniformed personnel assigned to the FMSCR unit, 19 of whom handle truck inspections full-time. Of the 19, 3 troopers handle

hazardous material inspections and weight enforcement. According to an Alabama Motor Carrier Division spokesperson, the FMSCR unit conducts 12,000 to 15,000 truck inspections and 30,000 to 35,000 weight inspections annually. In addition to conducting roadside inspections, the FMSCR units assist in motor accident investigations when requested.

Florida - The State of Florida does not participate in the MCSAP but has its own independent inspection program. The State's enforcement agency for commercial motor vehicle transportation is the Office of Motor Carrier Compliance (OMCC) In 1990, the OMCC performed safety inspections of 51,918 commercial motor vehicles, including almost 51,000 medium/heavy trucks. According to an OMCC official, approximately 52 percent of those commercial vehicles inspected during 1990 were "put out of service" for vehicle and driver deficiencies.

North Carolina - The truck involved in the Greensboro truck-wheel fatal accident was operating in intrastate commerce and therefore not subject to FMSCR, but governed by North Carolina regulations. The Motor Carrier Safety Unit (MCSU) of the North Carolina Department of Motor Vehicles has 42 officers assigned to inspect commercial vehicles throughout the State. According to an MCSU official, the unit inspected 62,173 commercial vehicles between October 1, 1989, and September 30, 1990, of which 20,337 vehicles and 4,091 drivers were "placed out of service."

South Carolina - The carrier involved in the Marion, North Carolina, accident was headquartered in South Carolina and subject to the interstate FMSCR and South Carolina statutes. According to a spokesperson for the South Carolina Public Service Commission, the State has 20 personnel dedicated to inspecting commercial vehicles. The South Carolina official stated that during fiscal year 1991 (October 1990-September 1991), the unit inspected 18,477 commercial trucks and buses, of which 4,883 vehicles were placed out of service.

While some studies call for more emphasis on tire and wheel inspections, the Safety Board believes that the current wheel inspection efforts are sufficient. Nonetheless, the Safety Board believes that States should collect accident data separately for tires and wheels and should periodically reassess the accident data collected to determine whether more emphasis on wheel inspections is needed.

Federal Oversight

Based on the relatively low number of wheel-separation accidents, the current level of Federal oversight appears sufficient. However, additional efforts should be made to encourage the trucking industry to use the NHTSA Hotline, and the FHWA and NHTSA should encourage collection of better accident data. In addition, the FHWA and NHTSA should, with industry, develop recommended maintenance guidelines and promote training in these areas.

Since this joint investigation began, the OMC has published a special "ON-GUARD" Bulletin to the trucking industry. The bulletin highlights some of the findings of the investigation and warns motor carriers about poor inspection and maintenance practices, advising them "to pay particular attention to manufacturers' torque specifications." (See appendix H.)

The "ON-GUARD" bulletin also advises carriers of two regulations promulgated January 1, 1992. The regulation at 49 CFR 396.25 requires the qualification of motor carrier personnel responsible for inspections, maintenance, repairs, or service to brakes; 49 CFR 396.19 requires that motor carriers use qualified personnel to perform annual inspections. These sections also require that motor carriers maintain evidence of the inspector's qualifications. The Safety Board believes that a requirement for maintenance personnel to be qualified can help reduce wheel-separation accidents if the qualification process includes training that emphasizes proper tightening procedures.

SECTION 6

CONCLUSIONS

1. Safety Board projections of state data indicate that nationwide, the incidence of medium/heavy truck-wheel separation accidents is small, about 750 to 1,050 per year, compared to the total number of truck accidents, about 349,000 annually. Wheel-separation accidents constitute about 0.3 percent of all truck accidents. From January 1989 through December 1991, fatal accidents resulting from wheel separations totaled 24, compared to 12,300 medium/heavy truck fatal accidents for the same period.
2. Based on Safety Board and national FARS data, OMC surveys, and carrier experience, the leading causes of wheel separations from medium/heavy trucks are improper tightening of wheel fasteners and bearing failure; both are the result of inadequate maintenance.
3. Undertightening of wheel fasteners usually results from the failure to follow recommended wheel maintenance practices, such as always using a torque wrench, following proper tightening procedures, using only compatible components, and avoiding paint build-up, debris, oil, or rust between wheel fasteners, threads, and mating surfaces.
4. Overtightening can more easily result from using an air impact wrench instead of a torque wrench.
5. The trucking industry lacks uniform model guidelines for maintenance and inspection of all types of medium/heavy truck wheels.
6. Wheel bearing failure can result from inadequate lubrication, bearing misalignment, improper bearing nut adjustment, or overload.
7. The trucking industry does not have a uniform recommended practice that specifies how often wheel bearings should be inspected.
8. Disc wheel failures can result from loose studs or cargo overload.
9. Most Federal and State accident reporting forms do not differentiate between tire and wheel failures.
10. Federal and State oversight of wheel inspections and recalls appears to be adequate.

SECTION 7

RECOMMENDATIONS

As a result of this special investigation, the National Transportation Safety Board made the following recommendations:

-- to the American Trucking Associations in cooperation with the National Wheel & Rim Association, the Motor Vehicle Manufacturers Association of the United States, Truck Trailer Manufacturers Association, and the Society of Automotive Engineers:

Develop and disseminate model guidelines for the inspection and maintenance of all types of medium/heavy truck wheels. (Class II, Priority Action) (H-92-98)

Develop uniform recommended practices that specify how often truck wheel bearings should be examined. (Class II, Priority Action) (H-92-99)

Promote an educational program on proper wheel tightening procedures through carriers, manufacturers, and government. (Class II, Priority Action) (H-92-100)

Encourage manufacturers to provide a label on trucks that indicates the recommended torque for wheel fasteners, proper tightening sequence, and recommended frequency for retorquing fasteners. (Class II, Priority Action) (H-92-101)

-- to the Federal Highway Administration, in cooperation with the American Trucking Associations, the National Wheel & Rim Association, the Motor Vehicle Manufacturers Association of the United States, Truck Trailer Manufacturers Association, and the Society of Automotive Engineers:

Support the development of an educational program on proper wheel tightening procedures by the carriers and manufacturers. (Class II, Priority Action) (H-92-102)

-- to the Department of Transportation:

Encourage the States to separate wheel defects from tire defects in future accident data collection efforts. (Class II, Priority Action) (H-92-103)

BY THE NATIONAL TRANSPORTATION SAFETY BOARD

CARL M. VOGT
Chairman

SUSAN M. COUGHLIN
Vice Chairman

JOHN K. LAUBER
Member

JOHN A. HAMMERSCHMIDT
Member

CHRISTOPHER A. HART
Member

September 15, 1992

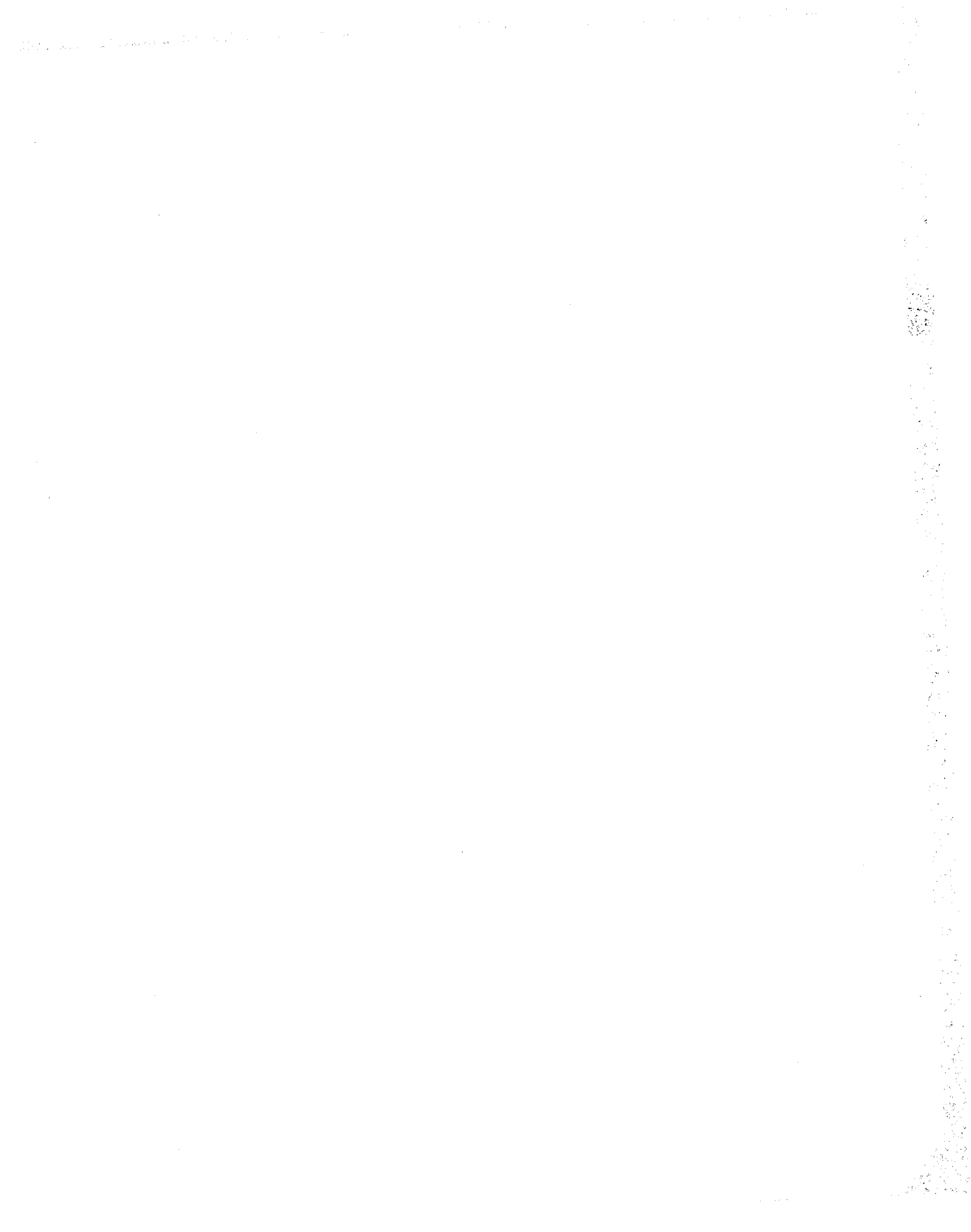

APPENDIX A

GLOSSARY

Cap nut - A nut that encloses the stud.

Center hole - The central hole in the disc portion of the wheel.

Clamp - The component part of the spoke wheel fastening system that retains the rim.

Cone seat - The portion of the disc that is formed into a conical shape to mate with a conical-shaped nut.

Demountable rim - A rim that can be detached from a spoke wheel. Since the rim is retained by clamps, no particular members attach the rim to the vehicle.

Disc - A center portion connecting a rim to an axle. Several holes are provided to attach the disc to the axle.

Disc wheel - A permanent combination of a rim and a disc used to attach it to the hub.

Dual wheel - A wheel with sufficient offset by the attachment face and rim centerline to provide dual spacing.

Flange - That part of a rim providing lateral support to the tire.

Hub - The component attached directly to the axle spindle through the bearings. This term usually applies to the rotating member to which a disc wheel is attached to the vehicle.

Multipiece rim - A rim that has at least one removable bead seat and flange to allow tire mounting.

Pilot - The act of locating an assembly, usually in the radial direction.

Rim - The part of the wheel on which the tire is mounted and supported.

Spacer - A band that separates two demountable rims on a spoke wheel to provide dual spacing for tires.

Spoke wheel - A wheel constructed such that one or two demountable rims are clamped to the wheel disc, which also serves as the hub support for the brake drum or disc brake rotor.

Stud - A "bolt-type" fastener used to attach the hub to the wheel that is secured by a cap nut.

Valve hole - The hole in the rim that allows the tube valve to be attached and air to enter the tire.

Valve slot - A slot in a tube-type rim that allows the tube valve to exit the tire side of the rim.

Wheel - A rotating load-carrying member between the tire and the axle.

APPENDIX B**TYPES OF WHEELS****Wheels**

Spoke wheels.-- The spoke wheel usually consists of a cast metal object with spokes radiating from the center. A rim with a tire is clamped onto the ends of the spokes (see figure 19). The rims are centered and held by wedging of clamps against the rim.

Disc wheels.--On a disc wheel, the rim is attached to a center member bolted to the hub on the axle (see figure 1 in section 1). The tire mounts directly onto the disc wheel. In the United States, disc wheels were first manufactured in 1918 after being observed in Europe during World War I.

The current industry trend is to change from spoke to disc wheels. Commercial buses in this country now use disc wheels exclusively, but school buses still use spoke wheels. In Europe, most vehicles have disc wheels. In the 1940s, West Coast carriers began using 22-inch disc wheels and, subsequently, 22.5-inch tubeless wheels, which resulted in lower revolutions per mile, better brake cooling, and better running conditions.

The West Coast carriers now predominately use disc wheels. Until recently, the East Coast carriers predominately used spoke wheels. More East Coast carriers are switching to disc wheels, in part to avoid having to adjust spokes to make them true. Also, increased spoke loading from higher torque brakes and heavier tare weights produces greater deformation or strain, although the design clamp force has been increased to compensate. The greater clamp force required that a higher grade of fasteners be used, resulting in the additional benefits of reduced overtorquing and stud bending.

The rim's basic purpose is to provide support to the tire bead and lower sidewall. The disc provides a load-supporting member between the rim and the hub, which is attached to the axle, and transfers drive and brake torque between the tire and the hub. The wheel attachment has two functions: to provide wheel retention under various load conditions and to allow wheel removal for servicing tire, brakes, bearings, or other components. Unlike some automotive wheels, which carry some of the loads through fasteners, the threaded fasteners for truck disc wheels are not designed to carry any vertical or rotational loads.

Within the discs are hand or vent holes that lighten the wheel and allow access to the valve, allow air circulation for brake cooling, and allow the wheel to be picked up. Clearances are allowed for the brake drum. Ribs are sometimes used in the disc for radial reinforcement. The center hole is used as a pilot to radially locate the wheel on the axle. The flange area provides interface with the rim and is either spot- or arc-welded. Sometimes the flange has spokes for noncontinuous support to minimize cost, material, and weight. The opening between the spokes provides some brake cooling.

The three basic wheel types are: steel, forged, and cast aluminum. Forged and cast wheels are primarily fabricated from aluminum and are popular because they are lightweight. Disc wheels use several types of mountings that employ different nut systems, pilot systems, and bolt patterns.

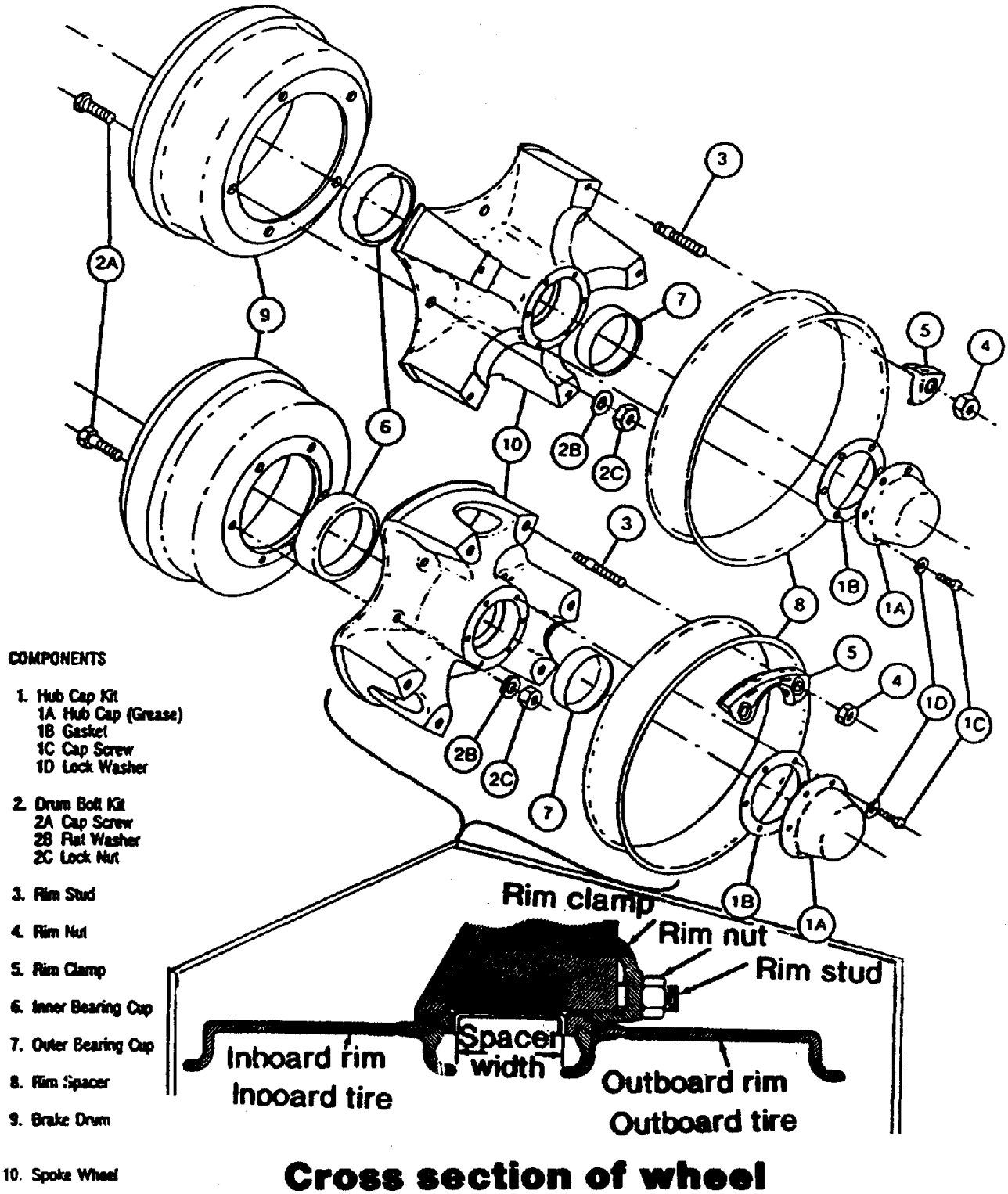

Figure 19.--Exploded view of two types of spoke wheel assemblies.

Many of today's wheel features were developed 50 to 75 years ago. In 1912, dual tires afforded trucks improved traction on poor roads, increased load capacity, and the ability to continue in the event of tire failure. The bolt pattern developed in 1928 is still used for disc wheels. The conical nut seat and the flanged nut mounting were also developed at this time (see figure 20). By 1935, two types of disc wheel attaching systems still used today for commercial vehicles became available-- the ball-seat nut-style disc wheels (double cap nut) and the hub-piloted disc wheels (cone lock nut).

The ball-seat nut-style disc wheels use 6 or 10 inner and outer cap nuts to center and clamp the disc wheels. The double cap nut uses a spherical countersink to locate the wheel. The inner wheel of a dual assembly is located on the hub by the countersink and the mating surface of the inner cap nut. The outside wheel is located by the spherical seats of the wheel and nut, which is screwed onto the inner nut.

Hub-piloted disc wheels are centered by the pilot on the hub and clamped by a single flange nut with a permanently attached washer. The flange nut system (see figure 19) uses a hub pilot to radially locate the center hole of the disc. A two-piece nut holds the disc securely in place. This mounting separates the locating and securing functions of the fasteners and wheel system. The two-piece nut minimizes torque loss in service. Hub-piloted wheels have 8 or 10 holes. Manufacturers frequently caution to treat each mounting system individually and not mix components.

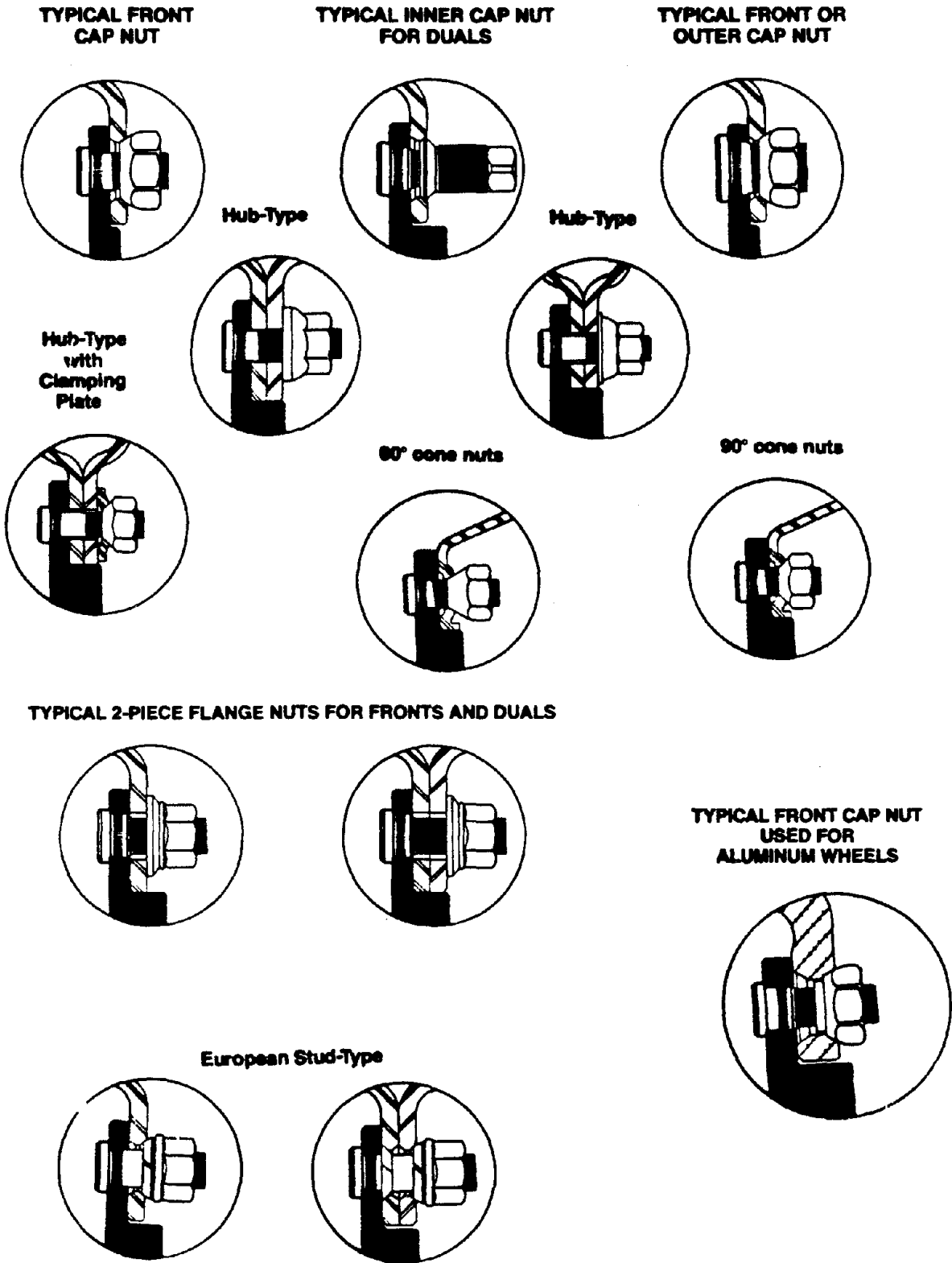

Figure 20.--Typical types of nuts to secure truck wheels.

APPENDIX C

CHARACTERISTICS OF FATAL ACCIDENTS INVOLVING WHEEL SEPARATIONS
1989-1991

<u>Characteristics</u>	<u>1989</u>	<u>1990</u> ²⁶	<u>1991</u> ²⁷	<u>Total</u>
Number of				
Accidents	8	5	11	24
Fatalities	8	7	13	28
Injuries	6	1	22	29
Accident type				
Hit another vehicle				20
Overtaken and burned				2
Hit a pedestrian				2
Tire location				
Left side				16
Right side				6
Spare				2
Tractor/single unit				15
Trailer				7
Spare				2
Age of vehicle				
0-8 years				8
9-16 years				8
Greater than 20				4
Unreported				4
Suspected failure mechanism				
Loose nuts on studs				7
Bearing failure due to seal				3
Fracture of the wheel's disk				1
Unknown				13

²⁶A fatal accident found in Oregon's files was added to the FARS data after review of the police report. This accident involved a 1-1/2 ton truck.

²⁷Does not include fatal accidents investigated by the Safety Board.

DETAILS OF FATAL ACCIDENTS²⁸

<u>Date</u>	<u>State</u>	<u>Type of truck/trailer</u>	<u>Age</u>	<u>Accident details</u>
1-4-89	CA	Peter tractor/trailer	16	Second right axle had recently been changed from steel to aluminum wheels and longer studs were not used, nuts did not have enough contact on stud, nuts were found loose, and 8 of 10 studs sheared; 1 fatality.
1-20-89	MO	Peterbilt left dual	5	1 fatality and 1 injury.
1-27-89	CA	KW 3 axle dump w/trailer	34	Second right axle of dump lost dual wheel when 5 bolts sheared and 5 bolts were stripped; 1 fatality.
6-19-89	CA	Mack single unit (right rear)	16	Shear at the studs, nuts were loose and one sheared bolt was rusted; cracks in other wheels had been inspected 3 months before the accident in CA; 1 fatality and 1 injury.
10-24-89	NY	Budd semitrailer (left rear)	12	1 fatality and 1 injury.
11-4-89	OK	Semitrailer (left rear) dual	--	1 fatality and 1 injury.
12-6-89	PA	Great Dane trailer (right rear)	--	1 fatality and 1 injury.
12-16-89	PA	Int. Tractor (left front)	10	1 fatality and 1 injury.
4-22-90	CA	Utility semitrailer	6	Old rusted cracks (right rear) in the wheel, 2 studs sheared and worn; 1 fatality and 1 injury.

²⁸Partial total given for 1991.

5-16-90	TX	Chev. dump truck (left rear)	22	1 fatality and 1 injury; ran off road and burned.
5-31-90	CA	Utility semitrailer (left rear)	5	Slow oil leak as indicated by dirt build-up behind brake shoe, inspected in CA 2 days before the wheel bearing failure; 1 fatality.
7-3-90	CA	Kenworth tractor (left rear axle)	11	Improper tightening of Rockwell inner axle nuts, locking washer and outer nut; 1 fatality.
7-14-90	OR	A 1-1/2 ton GMC (left rear dual)	24	The dual came off and struck a 1988 Buick LeSabre. The car's cruise control was engaged, and the car continued for over 1,400 feet before flipping twice, landing on a boulder upside down. One person was ejected from the car and the driver and another passenger were killed; 3 fatalities.
3-8-91	TX	Single Unit Chev.	6	1 fatality and 2 injuries.
4-10-91	NJ	GMC tractor right drive	12	8 of 10 studs sheared; 1 fatality and 1 injury.
5-31-91	CN			Witness thought it was a spare tire from truck in front, and tire bounced 40 feet in air rearward, over the witness's car; 1 fatality and 1 injury.
6-18-91	WV	Great Dane semitrailer-	--	The left rear outside wheel failed when the disc of the wheel cracked just outside the stud bolts. Extensive rust was

				present on the remaining portion of the wheel; 1 fatality (pedestrian).
7-4-91	OK	Aztec semitrailer	12	Spare tire from trailer came loose.
7-10-91	GA	GMC single unit (left rear)	21	1 fatality and 1 injury; overturn and fire.

APPENDIX D

OMC SURVEY OF CARRIER-REPORTED ACCIDENTS IN REGION 4

Legend

Wheel Code

R - Right
L - Left
Fr - Front
Re - Rear
Tag-Tag axle
Ste-Steering axle
Ta-Tandem axle
Dr-Drive axle

Separation-Type Code

Lugs - Lugs, studs, bolts broke
Axle - Axle failure
Blow - Precipitated by blowout
Nuts - Loose nuts
Bear - Bearing failure
SpltR- Split rim
Carr - Maintenance performed by carrier
Other - Maintenance performed outside shop

Case	Vehicle from which wheel separated	Wheel posit.	Age Veh. Axle	Type Sep.	Type Wheel	Maint./ repairs	Time to last insp.	Shop air press. (ft-lb)
* 1	Frtliner Tractor	LFrDr	7	Lugs	FirDi	Carr	3,000 mi	650
2	Frtliner Tractor	RReDr	12	Lugs	BudDi	2	90 days	
* 3	Grt Dane S-Trail	LFrTa	6	Lugs	WedDi	Carr	24 days	600
4	Bush Hog S-Trail	LReTa	6	Lugs	Disc	Carr	9 days	600
5	Trailmob S-Trail	LReTa	2	Other	Motwh	2	0 days-holes along	
6	Frtliner Tractor	RReDr	16	Lugs	FirDi	Carr	28 days-2 lugs miss	
7	Peterblt Tractor	RReDr	15	Lugs	FirDi	Carr	14-21 days	
8	Eagle Bus	LFrTag	11	Axle	Eagle	Carr	8 days	
(Case 8 was deleted from the truck study.)								
9	RSI Double trail	1LFrTa	11	Other	Disc	Carr		450
10	RSI Double trail	2LReTa	4	Lugs	Disc	Carr		450
11	Freuhauf S-trail	LReTa	14	Lugs	Disc	2	27 days	
12	Internat Tractor	RFrSte	12	Other	Disc	Own/Op		
13	Trailmob S-trail	RFrTa	20	Other	Spoke	2	10 days	600
14	Heil S-trail	LReTa	4	Other	Other	Lease	1 day	600
* 15	Frtliner Tractor	LFrDr	2	Nuts	MotDi	Lease	6 days	550
* 16	Mack Tractor	LFrSte	5	Bear	SudDi	2	Limited work	
17	Trailmob S-trail	LReTa	7	Lugs	Disc	2		
18	Ken. Tractor	RFrSte	13	Hub	Disc		6 days	250
19	Grt Dane S-trail	RFrTa	3	Other	Disc		25 days	425
20	Grt Dane S-trail	RFrTa	8	Lugs	Disc	Lease	16 days	550
21	Frtliner Tractor	RReDr	7	Blow	Other	2	Less than 35 days	
22	Fontaine S-trail	L Ta	2	Blow	Fir	2	18 days	450
* 23	Ford Tractor	LFrSte	9	Bear	Spok	Carr	28 days	
24	Ken. Tractor	LReDr	11	Other	AlcDi	2	0 days-new seal app.	
25	Ford E-350	LFrSte	4	Other	Ford	Carr	77 days	250
26	Trailmob S-trail	LFrTa	4	Bear	FirDi		less than 30 days	500
27	Fruehauf S-trail	RReTa	4	Other	DaySp		63 days	
28	Grt Dane S-trail	RFrTa	12	Other	DaySp		76 days	
29	Internat Tractor	RFrSte	5	Other			21 days	

30	Ken. Tractor	RFtSte	10	Bear				Lease
31	Ford F-700	LFtSte	5	Bear				35 days
	(Case 31 not included in the study since the bearing seized, but the wheel did not separate.)							
32	Mack Mid-Liner	LFtSte	8	Other	MacDi	2		3 days-bearing repl
33	TimpteRefS-trail	RFtTa	7	Lugs	AccDi			109 days 350
34	(Case 34 deleted; now part of Case 35.)							
35	Grt Dane S-trail	LReTa	0	Lugs	BudDi	2		less than 60 days
36	Ken. Tractor	L Dr	5	Lugs	MotDi			14 days 250
37	Volvo Tractor	LFtSte	4	Other				
38	Mack Tractor	RFtSte	2	Other	Disc			
39	Tibrook S-trail	LFtTa	2	SpltR	BudDi			4 days wk- 350
								67 days
40	Trailsta S-trail L	ReTa	3	Lugs	AlcDi	2		7 days 350
41	Boyd TanksS-trail	FtTa	5	Lugs	Disc			

APPENDIX E

WHEEL AND RIM MANUFACTURERS' MATERIAL

Wheel and Rim Manual (\$15 for 12 manufacturers' manuals)
National Wheel and Rim Association
5121 Bowden Road, Suite 303
Jacksonville, FL 32216-5950
(904) 737-2900

Accuride Rim/Wheel Safety and Service Manual
Accuride Corporation
P.O. Box 40
Henderson, KY 42420
(800) 626-7096

Alcoa Aluminum Truck Wheel Service Manual and Operating Instructions
Aluminum Company of America Wheel Products Division
1600 Harvard Avenue
Cleveland, OH 44105
(800) 242-9898

The Budd Company
Wheel and Brake Division
24755 Halsted Road
Farmington Hills, MI 48018
(313) 822-7000

Dayton Walther Corporation
2800 East River Road
Dayton, Ohio 45439
(513) 296-3191

Erie Wheels
Division of EMI Company
603 West 12th Street
Erie, PA 16501

Firestone Rim/Wheel Safety and Service Manual
Firestone Steel Products Company
2315 Adams Lane
Henderson, KY 42420
Attention Department 51-785

Goodyear and Motor Wheel On-Highway Rim and Wheel Safety and Service Manual
Form No. TR89-2538
Motor Wheel and Rim Catalog for Trucks, Trailers, and Buses
Catalog No. TW91-6144 (Not as detailed.)
(Some of the pages are different from the Wheel and Rim Manual.)
Wheel/Rim Safety
1116 N. Washington
Lansing, MI 48906-4841

Gunite Corporation
302 Peoples Avenue
Rockford, IL 61108

Kelsey-Hayes Company
38481 Huron River Drive
Romulus, MI 48174

Maintenance Is Not Magic - An Effective Wheel Maintenance Guide
(Different from the Wheel and Rim Manual.)
The Budd Company Wheel and Brake Division
12141 Charlevoix Avenue
Detroit, MI 48215
(313) 822-7000

Installation, Service, and Safety Instructions
Webb Wheel Products, Inc.
2310 Industrial Drive, S.W.
Cullman, AL 35055
(205) 739-6246

Redco Corporation
P.O. Box 110
Red Lion, PA 17356

The Timken Company
Canton, OH 44706

APPENDIX F

RECOMMENDED NUT TORQUE FOR MEDIUM/HEAVY TRUCKS AND TRAILERS

<u>Mounting Type/ Manufacturer</u>	<u>Thread Size</u>	<u>Torque (ft-lb)</u>	<u>Nut Type</u>
Accuride			
10 Hole, 13.189" Stud Piloted	15/16-12	750-800	1.187" sph.rad.
10 Hole, 335mm Hub Piloted	1-5/16-12	750-800	1.187" sph.rad.
	M22x1.5	390-500	two piece flange
10 Hole, 11-1/4" Stud Piloted	3/4-16	450-500	.875" sph.rad.
10 Hole, 11-1/4" Hub Piloted	1-1/8-16	450-500	.875" sph.rad.
	3/4-16	300-350	two piece flange
10 Hole, 285.75mm Hub Piloted	M22x1.5	390-500	two piece flange
10 Hole, 8.75" Hub Piloted	11/16-16	300-350	one piece flanged
10 Hole, 8.75" Stud Piloted	3/4-16	450-500	.875" sph.rad
	1-1/8-16	450-500	.875" sph.rad
8 Hole, 275mm Hub Piloted	M20x1.5	280-310	two piece flange
	M22x1.5	390-500	two piece flange
Demountable Rims			
	5/8-11	150-175	flat nut
	3/4-10	210-260	flat nut
Alcoa			
Stud-located, ball-seat mounting system	Inner & single	400-500 300-375	threads not lubricated threads lubricated
Hub Piloted	33mmhexhead	400-500	
Budd			
Straight Stud holes with flanged cap nuts	11/16"-16	300-400	
	M20x1.5	295-330	
	M22x1.5	390-500	
Standard Ball-Seat Mounting	3/4"-16	450-500	
	1-1/8"-16	450-500	up to 750#' using shoulder studs with 7/8" or 1" back nut or headed bolts
Dayton			
5-, 6-, & 3-spoke wheels	5/8"	160-175	Front 160-175 Rear
	3/4"	240-260	Front 190-210 Rear

Erie		
Ermix spoke wheels for trailers	3/4"	180-200
Disc wheel Stud Pilot Mount		450-500
Disc wheel Hub Pilot Mount		500-550
Firestone		
Steel disc Stud-type Mount-10		450-500
Stud Pilot Nuts - FSP		250-300 Use with grade 5 studs
Accu-Forge Aluminum wheels		450-500
Duplex wheels with heavy duty mounting		750-800
Gunite		
PRE FMVSS 121	5/8"x11	160-185
	3/4x10	200-225
FMVSS 121-Front less than 15,000	3/4x10	200-225
Front/15000# and over	3/4x10	240-265
Rear/All	3/4x10	200-225
Steel		
Std. Single cap nut mounting	1 1/16"-16	300-400
Std. Double cap nut mounting	3/4"-16	450-500
	7/8"-16	450-500
	1-1/8"-16	450-500
Backnut (Inner end of wheel stud)	3/4"-16	175-200
	7/8"-15	175-250
	1"-14	175-300
Aluminum		
Lubricated		300-375
Dry		450-500
Kelsey		
	5/8"-11	160-175
	3/4"-10	200-225
FMVSS		
121-Front/12000# and less		200-225
Front/over 12,000#		240-265
Rear/all		200-225
Goodyear/Motor Wheel		
Disc Wheels		
Double Cap Nut		
DCN Mounting-countersunk holes	3/4"-16	450-500
	1-1/8"-16	450-500
Cone Lock Nut		
CLN Mounting-2 pc. nuts	M22x1.5	450-550
(WHD-8" WHD-10 Systems)		
CLN Mounting-2 pc. nuts	9/16"-18	175-225
	11/16"-16	250-300
	3/4"-16	300-350
Back Nuts-on inner end of wheel stud		
	3/4"-16	175-200

Flanged Cap Nuts-1 pc. nut	11/16"-16	300-350
Cast Wheels - Demountable Rims	1/2"-13	90
	5/8"-11	160-175
	3/4"-10	175-225
Redco		
	3/4"-16	450-470
	1-1/8"-16	450-470
Webb		
Ball Seat Disc Wheels 6&10 studs		450-500
Pilot Mount Disc Wheels 8&10 studs		500-550
Spoke wheels	3/4"	200-250

APPENDIX G

MANUFACTURERS' RECOMMENDATIONS FOR THE REPLACEMENT OF BROKEN STUDS

Replace rim studs that are missing - Dayton.

Replace any broken studs - Accuride (Demountable Rims) and Redco.

If stud replacement is necessary, use normal procedures - Motor Wheel.

Replace the broken stud and one on each side of the broken stud-
Accuride (Disc, Forge), Budd, Dayton, Erie, Firestone, Gunitite, Webb, and Volvo.

If more than one stud is broken, replace all the studs - Erie and Gunitite.

If more than two studs are broken, replace the entire set - Webb and Volvo.

APPENDIX H

OMC "ON GUARD" BULLETIN

On Guard



U.S. Department of Transportation
Federal Highway Administration

Prepared by
Office of Motor Carriers

Vol. 21, No. 1
Washington, D.C.

May 1992

WHEEL SEPARATIONS

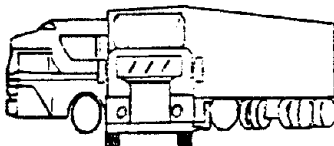

WHEEL SEPARATIONS! Recently several motor carriers have had serious accidents resulting in injuries and fatalities due to wheel separations. In Miami, Florida, a school bus was struck head on by a wheel and tire that had sheared off the steering axle of a straight truck. Investigation determined the wheel bearing seized and the axle spindle sheared. The tire and wheel bounced over a concrete median barrier into the windshield of the bus. Two children were killed instantly, one adult died of injuries later. The motor carrier was unable to present any indication or evidence that the vehicle had ever been inspected or maintenance performed.

This and other wheel separations appear to have resulted, at least in part, from poor inspection and maintenance practices. Wheel separations may be caused by inadequate lubrication, faulty hardware (counterfeit bolts), over-torquing wheel nuts, or allowing the vehicle to operate with loose wheel nuts. Lost wheels also result from improperly secured spares. A systematic inspection, repair and maintenance program (as required by Federal Motor Carrier Safety Regulations, 49 CFR 396.3) can help detect small problems before they become accidents.

The FHWA has conducted a wheel separation accident study to determine if there is a pattern, either mechanical or maintenance related, behind these wheel separation accidents. Initial results indicate that manufacturers' recommended practices may not have been followed during inspection and repair of wheel or hub assemblies.

The FHWA is advising motor carriers to pay particular attention to manufacturers' torque specifications when adjusting wheel bearings and tightening wheel nuts and bolts. Carriers should also, as a part of their normal inspection procedure, check wheel assemblies for cracks and to ensure that fastener torque ranges are maintained.

Two recent regulatory changes have been promulgated to improve inspection and maintenance practices. Effective January 1, 1992, 49 CFR 396.25, motor carrier personnel responsible for inspections, maintenance, repairs or service to brakes must be qualified. Also, 49 CFR 396.19 requires motor carriers to use qualified personnel to perform an annual inspection. These sections require motor carriers to maintain evidence of the inspector's qualifications.

