

# ABRASIVE PRODUCTS

## GRINDING WHEELS

### Reinforced Wheels Depressed Center

FOR USE ON RIGHT  
ANGLE GRINDERS



- Aluminum oxide abrasive with a resin bond reinforced by layers of durable fabric to provide wheels of maximum strength and safety.
- **Fast cutting** flexible, extremely durable, and economical.

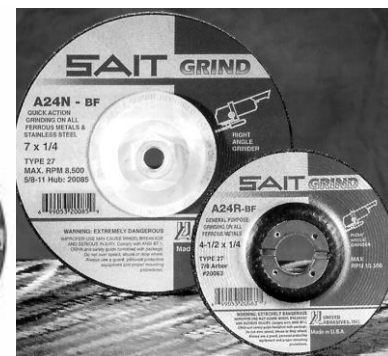

| J&B #    | MFG #  | SIZE        | ARBOR      | MATERIAL | MAX RPM | QTY | CASE |
|----------|--------|-------------|------------|----------|---------|-----|------|
| ~ 39061  | 20015  | 4 x 1/4     | 5/8 hole   | A24N     | 13,500  | EA  | 25   |
| ~ 38864  | 20163  | 4-1/2 x 1/4 | 5/8-11 nut | A24R     | 13,300  | EA  | 10   |
| * 49115  | A1226H | 4-1/2 x 1/4 | 5/8-11 nut | A24/30T  | 13,300  | EA  | 10   |
| * V41990 | A1203H | 4-1/2 x 1/4 | 5/8-11 nut | A24ALU   | 13,300  | EA  | 10   |
| * 38865  | A1236  | 4-1/2 x 1/4 | 7/8 hole   | A24T     | 13,300  | EA  | 25   |
| * V41991 | A1203  | 4-1/2 x 1/4 | 7/8 hole   | A24ALU   | 13,300  | EA  | 25   |
| ~ 38866  | 20070  | 5 x 1/4     | 7/8 hole   | A24N     | 12,200  | EA  | 25   |
| * V20097 | A3236  | 6 x 1/4     | 7/8 hole   | A30N     | 10,000  | EA  | 25   |
| ~ 20098  | 20086  | 7 x 1/4     | 5/8-11 nut | A24R     | 8,500   | EA  | 10   |
| ~ 20146  | 20195  | 9 x 1/4     | 5/8-11 nut | A24T     | 6,600   | EA  | 10   |

\* = Flexovit Brand ~ = Sait Brand

#### GENERAL PURPOSE - METAL - FAST CUT (A24N):

- Aggressive grinding with excellent life.
- Grinds aggressively in a wide range of metal applications, including harder materials.
- Aluminum oxide grain. Soft bond for fast stock removal.

#### HIGH PERFORMANCE - METAL - LONG LIFE (A24R):

- Smooth grinding with maximum life for an aluminum oxide wheel.
- Weld grinding, surface conditioning, notching, cutting, and all general purpose stock removal.
- The standard for long life in metal work.

#### EDGE GRINDING - METAL - LONG LIFE (A24T):

- Aluminum oxide grain.
- Hard bond designed for edge & bevel grinding & other applications where a harder wheel is preferred.
- Ferrous metals (iron, steel, welds, etc.)

#### ALUMINUM - LOAD RESISTANT - (A24ALU)

- Ideal for grinding aluminum and nonferrous materials.

# ABRASIVE PRODUCTS

## METALHOG GRINDING WHEEL

Reinforced Wheels Depressed Center

**\*\* Superior Productivity    \*\* Higher Efficiency    \*\* Longer Life**

FOR USE ON RIGHT ANGLE GRINDERS



- Type 27 grinding wheels incorporate a blend of premium, semi-premium & standard abrasive grain with custom bond systems.
- Extremely aggressive & rapid grinding action without sacrificing wheel life.
- METALHOG grinds up to 30% faster & 3 times Longer than regular aluminum oxide products.



| J&B # | MFG # | SIZE        | ARBOR    | MATERIAL | MAX RPM | QTY | CASE |
|-------|-------|-------------|----------|----------|---------|-----|------|
| 41908 | A1230 | 4-1/2 x 1/4 | 7/8 hole | AXT24S   | 13,300  | EA  | 25   |

**RAPID GRIND – METAL, STAINLESS - FAST CUT/LONG LIFE (AXT24S):**

- Fast, aggressive stock removal.

## E.T. ERGONOMIC TECHNOLOGY

Flexovit

FOR USE ON ANGLE GRINDERS



- New saucer shaped grinding wheel incorporating ergonomic technology. Allows **more contact area** between the wheel & the workpiece, resulting in more controlled grinding & blending without gouging & with **less pressure required**.
- Intended for flat surfaces & rugged edge grinding.
- Designed to fit under standard angle grinder guards.
- Built with 3 full layers of high tensile fiberglass reinforcement for maximum workplace safety.



| J&B # | MFG # | SIZE              | SPEC | MAX RPM | QTY | CASE |
|-------|-------|-------------------|------|---------|-----|------|
| 49100 | A1237 | 4-1/2 x 1/4 x 7/8 | A30S | 13,300  | EA  | 25   |

# ABRASIVE PRODUCTS

## CHALLENGER II GRINDING WHEELS

Semi-Flexible Wheels  
ALUMINUM / STAINLESS / METAL

FOR USE ON RIGHT ANGLE GRINDERS

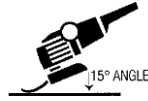

MUST BE USED AT A  
MINIMUM 15° ANGLE  
- DO NOT USE FLAT -



- Eliminate wheel-change downtime by grinding and finishing with the same wheel.
- **Challenger II** performs well in all metal fabrication applications.
- **Challenger II** runs virtually LOAD-FREE.
- **Challenger II** tackles stainless and hard alloy applications without glazing or dulling.
- Great for Metal, Stainless, or Aluminum.

| J&B #  | MFG # | SIZE        | TYPE | ARBOR    | GRIT | MAX RPM | QTY |
|--------|-------|-------------|------|----------|------|---------|-----|
| *42200 | 27501 | 4-1/2 x 1/8 | 29   | 7/8 hole | 60   | 13,280  | EA  |

25 in a case

\* Use backing pad part # 95245 from United Abrasives.



Type 29

# ABRASIVE PRODUCTS

## ZIRCOTEX PREMIUM FLAP DISCS

Fiberglass Backing Plate

FOR USE ON ANGLE GRINDERS



- Made with premium zirconia alumina abrasive cloth backed by a high strength fiberglass disc.
- Ideal for high production grinding, blending, deburring and finishing.
- Perform well on a wide variety of materials including stainless & carbon steel.
- Durable grain resists loading or clogging on softer materials such as aluminum, brass, bronze & fiberglass.
- The fanned, abrasive cloth flaps wear evenly, constantly exposing new, sharp grain allowing for full use of the disc



| J&B # | MFG #   | SIZE           | GRIT | TYPE | MAX RPM | QTY | CASE |
|-------|---------|----------------|------|------|---------|-----|------|
| 45401 | Z4501FH | 4-1/2 x 5/8-11 | 24   | 29   | 13,300  | EA  | 10   |
| 45402 | Z4500FH | 4-1/2 x 5/8-11 | 40   | 29   | 13,300  | EA  | 10   |
| 45416 | Z4505FH | 4-1/2 x 5/8-11 | 60   | 29   | 13,300  | EA  | 10   |
| 45500 | Z4510FH | 4-1/2 x 5/8-11 | 80   | 29   | 13,300  | EA  | 10   |
| 45422 | Z4525F  | 4-1/2 x 7/8    | 24   | 27   | 13,300  | EA  | 10   |
| 45406 | Z4530F  | 4-1/2 x 7/8    | 40   | 27   | 13,300  | EA  | 10   |
| 45398 | Z4535F  | 4-1/2 x 7/8    | 60   | 27   | 13,300  | EA  | 10   |
| 45408 | Z4540F  | 4-1/2 x 7/8    | 80   | 27   | 13,300  | EA  | 10   |
| 47005 | Z4545F  | 4-1/2 x 7/8    | 120  | 27   | 13,300  | EA  | 10   |
| 45412 | Z4500F  | 4-1/2 x 7/8    | 40   | 29   | 13,300  | EA  | 10   |
| 45409 | Z4505F  | 4-1/2 x 7/8    | 60   | 29   | 13,300  | EA  | 10   |
| 45420 | Z4510F  | 4-1/2 x 7/8    | 80   | 29   | 13,300  | EA  | 10   |

## SAIT ENCORE FLAP DISC

Fiberglass Backing Plate

- Heavy duty for long-life and high stock removal.
- Use on carbon and stainless steel, made with premium zirconium abrasive material which provides long-life & high stock removal.



| J&B # | MFG # | SIZE        | GRIT | TYPE | MAX RPM | QTY | CASE |
|-------|-------|-------------|------|------|---------|-----|------|
| 45399 | 71205 | 4-1/2 x 7/8 | 36   | 27   | 13,300  | EA  | 10   |
| 45400 | 71206 | 4-1/2 x 7/8 | 40   | 27   | 13,300  | EA  | 10   |
| 49102 | 71208 | 4-1/2 x 7/8 | 60   | 27   | 13,000  | EA  | 10   |



# ABRASIVE PRODUCTS

## TORNADO FLAP DISC

Nylon Backing

FOR USE ON ANGLE GRINDERS



- Nylon backing for easy, burn-free trimming.
- Safe & durable, vented for air cooling.
- Integrated, no strip thread –ready for mounting, no flange adaptor required.
- Premium zirconia cloth for high productivity.
- High performance & long life, resists loading & glazing.



Type 29

| J&B # | MFG #   | SIZE           | GRIT | TYPE | MAX RPM | QTY | CASE |
|-------|---------|----------------|------|------|---------|-----|------|
| 42201 | Z4500NT | 4-1/2 x 5/8-11 | 40   | 29   | 13,300  | EA  | 10   |
| 42202 | Z4505NT | 4-1/2 x 5/8-11 | 60   | 29   | 13,300  | EA  | 10   |
| 42203 | Z4510NT | 4-1/2 x 5/8-11 | 80   | 29   | 13,300  | EA  | 10   |
| 42204 | Z4520NT | 4-1/2 x 5/8-11 | 120  | 29   | 13,300  | EA  | 10   |

## OVATION FLAP DISCS

Fiberglass Backing Plate

FOR USE ON ANGLE GRINDERS



- High pressure is ideal for removing deeper scratches from the work surface.
- Heavy duty / long life for tough applications.
- Premium zirconium grain on a tough, full polyester backing.
- Will not contaminate stainless steel.



Type 27

| J&B # | MFG # | SIZE    | GRIT | TYPE | MAX RPM | QTY | CASE |
|-------|-------|---------|------|------|---------|-----|------|
| 59125 | 78036 | 6 x 7/8 | 40   | 27   | 10,200  | EA  | 10   |

# ABRASIVE PRODUCTS

## OVATION ATTACKER PLUS

Plastic Backing

FOR USE ON ANGLE GRINDERS



- High performance zirconium grain for a wide variety of grinding and finishing applications.
- Provides long life while maintaining high stock removal rates.
- 40% more material than conventional, regular density flap discs.
- For Stainless steel, high tensile steel, titanium, ferrous metals, non-ferrous metals (aluminum, copper, brass, etc).



Type 27

| J&B #  | MFG # | SIZE        | GRIT | TYPE | MAX RPM | QTY | CASE |
|--------|-------|-------------|------|------|---------|-----|------|
| V21515 | 72216 | 4-1/2 x 7/8 | 60   | 27   | 13,300  | EA  | 10   |
| V21522 | 72217 | 4-1/2 x 7/8 | 80   | 27   | 13,300  | EA  | 10   |

## OVATION CERAMIC PLUS

Plastic Backing

FOR USE ON ANGLE GRINDERS



- Premium ceramic grain outlasts conventional zirconium in most applications.
- Cooler cutting and fast, consistent finishes.
- 40% more material than conventional, regular density flap discs.
- For ferrous and/or non-ferrous metals, stainless steel and high tensile steel, titanium.



Type 27

| J&B #  | MFG # | SIZE        | GRIT | TYPE | MAX RPM | QTY | CASE |
|--------|-------|-------------|------|------|---------|-----|------|
| V21500 | 72228 | 4-1/2 x 7/8 | 60   | 27   | 13,300  | EA  | 10   |

# ABRASIVE PRODUCTS

## OVATION CERAMIC

FOR USE ON ANGLE GRINDERS



- Premium ceramic grain outlasts conventional Zirconium in most applications.
- Cooler cutting and fast consistent finishes.
- 40% more material than conventional, regular density flap discs.
- For Stainless steel, high tensile steel, titanium, ferrous metals, non-ferrous metals (aluminum, copper, brass, etc).



Type 27

| J&B #  | MFG # | SIZE        | GRIT | TYPE | MAX RPM | QTY |
|--------|-------|-------------|------|------|---------|-----|
| V41424 | 78261 | 4-1/2 x 7/8 | 40   | 27   | 13,300  | EA  |

**CASE**  
10

# ABRASIVE PRODUCTS

## GRINDING WHEELS

FOR USE ON BENCH & PEDESTAL MACHINES



- ALUMINUM OXIDE for metal grinding carbon, stainless or alloys.
- Runs cool for long grinding life; maintains shape.
- May be used for general purpose grinding or finishing and sharpening.

| J&B # | MFG # | SIZE  | ARBOR | NESTED BUSHINGS  | STYLE  | GRIT | MAX RPM | QTY |
|-------|-------|-------|-------|------------------|--------|------|---------|-----|
| 39030 | U4730 | 6 x 1 | 1     | 1/2, 5/8, 3/4    | MED/FN | A60  | 4,138   | EA  |
| 38460 | U4710 | 6 x 1 | 1     | 1/2, 5/8, 3/4    | COARSE | A24  | 4,138   | EA  |
| 39032 | U5130 | 8 x 1 | 1-1/4 | 1/2, 5/8, 3/4, 1 | MED/FN | A60  | 3,600   | EA  |
| 38462 | U5110 | 8 x 1 | 1-1/4 | 1/2, 5/8, 3/4, 1 | COARSE | A24  | 3,600   | EA  |

## BENCH WHEEL DRESSER

- Designed to true bench wheels to correct shape.
- Quickly remove foreign material embedded in the face of the wheel.

| J&B # | DIAMETER           | THICKNESS | QTY |
|-------|--------------------|-----------|-----|
| 39127 | Up to 10"          | Up to 2"  | EA  |
| 39128 | Replacement Cutter |           | EA  |

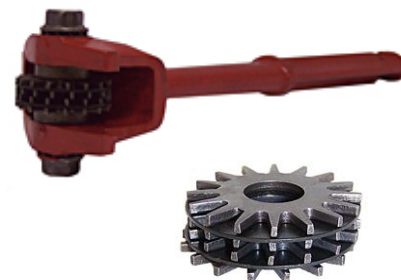

## RESIN FIBER ABRASIVE DISCS

Closed Coat

FOR USE ON RIGHT ANGLE GRINDERS



- Closed coat structure for more material removal & better finishing.
- Use for grinding mild steel or stainless, weld preparation, or blending and finishing.



| J&B #  | MFG # | SIZE        | GRIT | QTY |
|--------|-------|-------------|------|-----|
| 41410  | 32218 | 4-1/2 x 7/8 | 50   | 25  |
| 41412  | 32220 | 4-1/2 x 7/8 | 80   | 25  |
| *38963 | 32231 | 5 x 7/8     | 24   | 25  |
| 41416  | 32232 | 5 x 7/8     | 36   | 25  |
| 41418  | 32234 | 5 x 7/8     | 60   | 25  |
| 41419  | 32235 | 5 x 7/8     | 80   | 25  |
| 41421  | 32237 | 5 x 7/8     | 120  | 25  |

| J&B #  | MFG #  | SIZE    | GRIT | QTY |
|--------|--------|---------|------|-----|
| *38965 | 32246  | 7 x 7/8 | 24   | 25  |
| *38967 | S4010G | 9 x 7/8 | 24   | 25  |

\* These items are sold in box quantities only.



# ABRASIVE PRODUCTS

## RESIN FIBER ABRASIVE DISCS

### Open Coat

FOR USE ON RIGHT ANGLE GRINDES

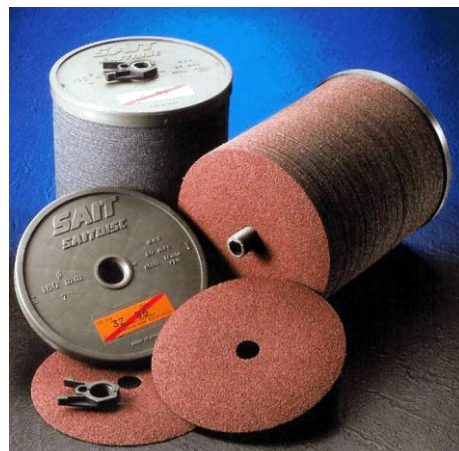

- Open coat structure prevents loading with fast material removal
- Use on ferrous and/or non-ferrous metals, wood and fiberglass.
- Discs come on handy dispenser to prevent bowing.

| J&B #  | MFG # | SIZE        | GRIT | QTY |
|--------|-------|-------------|------|-----|
| 46439  | 52480 | 4-1/2 x 7/8 | 80   | 100 |
| 46438  | 52460 | 4-1/2 x 7/8 | 60   | 100 |
| 46437  | 52450 | 4-1/2 x 7/8 | 50   | 100 |
| 46436  | 52436 | 4-1/2 x 7/8 | 36   | 100 |
| *46445 | 69226 | 4-1/2 x 7/8 | 36   | 100 |
| 46430  | 52750 | 7 x 7/8     | 50   | 100 |
| 46036  | 52736 | 7 x 7/8     | 36   | 100 |
| 46429  | 52724 | 7 x 7/8     | 24   | 50  |
| 46440  | 52716 | 7 x 7/8     | 16   | 100 |

- Cannot break box quantities -

\* Part# 46445 is a closed coat zirconia alumina abrasive material on an X-weight, water resistant polyester/cotton blended backing. For general purpose grinding and finishing on ferrous and non-ferrous metals, cast iron, aluminum, stainless steel and wood materials.

## SPIRALCOOL BACKING PAD

- Spiralcool backing pads exclusive rubber, fabric and fiber board construction provide extra strength and reliability.
- Spiral ribs provide contact points and form channels for air flow extending disc life 30% to 50%.



| J&B # | MFG # | SIZE   | ARBOR  | GRADE  | MAX RPM | QTY |
|-------|-------|--------|--------|--------|---------|-----|
| 41959 | 95011 | 4-1/2" | 5/8    | HARD   | 11,000  | EA  |
| 41983 | 95016 | 5"     | 5/8    | MEDIUM | 10,000  | EA  |
| 41972 | 95018 | 7"     | 5/8-11 | MEDIUM | 8,500   | EA  |

# ABRASIVE PRODUCTS

## ULTIMATE CUT CUT-OFF WHEELS

FOR USE ON RIGHT ANGLE GRINDERS



- Best in class – cutting a wide range of stainless thin & thick gauge, flat stock, bar stock, square tubing, etc.
- Exceptional cutting performance on metal & aluminum.
- Maximizes productivity.

| J&B # | MFG # | SIZE  |      |       | TYPE | MAX RPM | QTY |
|-------|-------|-------|------|-------|------|---------|-----|
|       |       | DIA   | THK  | ARBOR |      |         |     |
| 49106 | 23152 | 3     | .035 | 1/4   | 1    | 25,000  | 10  |
| 38464 | 22230 | 4-1/2 | .045 | 7/8   | 1    | 13,300  | 10  |
| 38466 | 22240 | 6     | .045 | 7/8   | 1    | 10,200  | 10  |

**NOTE: CUT-OFF WHEELS ARE FOR USE ON RIGHT ANGLE GRINDERS EQUIPPED WITH PROPER TYPE 1 FLANGES. DO NOT USE WITH TYPE 27 STYLE FLANGES.**

| J&B # | DESCRIPTION            | QTY |
|-------|------------------------|-----|
| 41407 | TYPE 1, ADAPTER FLANGE | EA  |

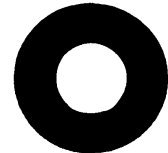

## ALUMINUM CUT-OFF WHEELS

FOR USE ON RIGHT ANGLE GRINDERS



- For cutting non-ferrous metals...aluminum, copper, brass, etc. Made of aluminum oxide grain.
- Soft bond for aggressive cutting without loading.
- Use with reusable 5/8-11 adapter to fit angle grinders.

| J&B # | MFG # | SIZE  |      |       | TYPE | MAX RPM | QTY |
|-------|-------|-------|------|-------|------|---------|-----|
|       |       | DIA   | THK  | ARBOR |      |         |     |
| 42065 | 23314 | 4-1/2 | .045 | 7/8   | 1    | 13,300  | 10  |



# ABRASIVE PRODUCTS

## RAZORBLADE EZ

FOR USE ON RIGHT ANGLE GRINDERS



- This wheel is for applications where getting the job done fast is the priority.
- .040 thickness... thinner than the typical .045 thickness.
- For metal and stainless. Type A60RRT material.



| J&B # | MFG # | SIZE  |      |       | TYPE | MAX RPM | QTY |
|-------|-------|-------|------|-------|------|---------|-----|
|       |       | DIA   | THK  | ARBOR |      |         |     |
| 12525 | F1206 | 4-1/2 | .040 | 7/8   | 1    | 13,300  | 10  |
| 45572 | F1706 | 6     | .040 | 7/8   | 1    | 10,200  | 10  |

**NOTE:** CUT-OFF WHEELS ARE FOR USE ON RIGHT ANGLE GRINDERS EQUIPPED WITH PROPER TYPE 1 FLANGES. DO NOT USE WITH TYPE 27 STYLE FLANGES.

| J&B # | DESCRIPTION            | QTY |
|-------|------------------------|-----|
| 41407 | TYPE 1, ADAPTER FLANGE | EA  |

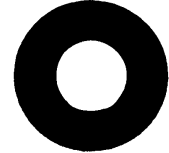

# ABRASIVE PRODUCTS

## HIGH SPEED CUT-OFF WHEELS

FOR USE ON RIGHT ANGLE GRINDERS



- Cuts ferrous & non ferrous metals (iron, steel, welds, etc.)
- Thin wheel, fast cutting with long life.
- Cut-off wheels are dressed so they cut instantly.
- Premium cutting speed and life in sheet metal or solids. Outstanding in stainless or alloys.

| J&B # | SIZE  |            | MFG            | TYPE | GRADE | MAX RPM | QTY |
|-------|-------|------------|----------------|------|-------|---------|-----|
|       | DIA   | THK ARBOR  |                |      |       |         |     |
| 41408 | 4-1/2 | .045 x 7/8 | SAIT 23101     | 1    | A60S  | 13,300  | 10  |
| 43500 | 4-1/2 | .045 x 7/8 | FLEXOVIT F1207 | 1    | A60S  | 13,300  | 10  |
| 40259 | 6     | .045 x 5/8 | SAIT 23105     | 1    | A60S  | 10,200  | 10  |
| 42122 | 6     | .045 x 7/8 | SAIT 23106     | 1    | A60S  | 10,200  | 10  |
| 42166 | 6     | .045 x 7/8 | FLEXOVIT F1707 | 1    | A60S  | 10,000  | 10  |

- Some angle grinders are not equipped with flanges that permit proper tightening of thin cutoff wheels. For most 4-1/2", 5" and 6" angle grinders, J&B offers a compatible reusable adapter flange.



| J&B # | DESCRIPTION             | QTY |
|-------|-------------------------|-----|
| 41407 | 1-3/4" DIA 5/8-11 Arbor | EA  |

## HIGH SPEED CUT-OFF WHEELS

- Aluminum oxide grain.
- Hard bond for aggressive cutting on rough applications.
- Cuts ferrous metals (iron, steel, welds, etc.) and stainless.



| J&B # | SIZE |            | MFG        | TYPE | GRADE | MAX RPM | QTY |
|-------|------|------------|------------|------|-------|---------|-----|
|       | DIA  | THK ARBOR  |            |      |       |         |     |
| 41839 | 6    | .035 x 7/8 | SAIT 23210 | 1    | A36T  | 10,186  | 10  |

# ABRASIVE PRODUCTS

## CUT-OFF WHEELS Depressed Center

FOR USE ON RIGHT ANGLE GRINDERS



- The Razorblade 27 wheel combines fast, chatter free cutting with exceptional wheel life, making it the wheel of choice where wheel usage is high and wheel change downtime is a concern.
- Facilitates flush cutting on flat surfaces.

| J&B #  | MFG # | SIZE  |        |       | TYPE | GRADE     | MAX RPM | QTY |
|--------|-------|-------|--------|-------|------|-----------|---------|-----|
|        |       | DIA   | THK    | ARBOR |      |           |         |     |
| 42042  | A0481 | 4-1/2 | x .045 | x 7/8 | 27   | A60SST-27 | 13,300  | 10  |
| V41989 | A2481 | 6     | x .045 | x 7/8 | 27   | A60SST-27 | 10,000  | 10  |

## CUT-OFF WHEEL Depressed Center

- Unique, thin type 27/ type 42 shape can be used on all angle grinders in accordance with ANSI B7.1.
- Unique formulations offer the fastest cutting, longest lasting thin wheels.
- Externally reinforced with fiberglass layers to provide ultimate safety in a thin wheel.
- Proprietary bonding system allows for faster, burr free cuts.



| J&B # | MFG # | SIZE  |        |       | TYPE    | GRADE | MAX RPM | QTY |
|-------|-------|-------|--------|-------|---------|-------|---------|-----|
|       |       | DIA   | THK    | ARBOR |         |       |         |     |
| 49108 | 22021 | 4-1/2 | x .045 | x 7/8 | 27 / 42 | A60S  | 13,300  | 10  |

# ABRASIVE PRODUCTS

---

## PORTABLE SAW CUT-OFF WHEELS Extremely Fast Cutting

- Special aluminum oxide grain formula.
- Fast cutting action. Non-binding cutting formula.
- Externally reinforced with the highest quality fiberglass.
- Cuts ferrous metals, stainless steel, high tensile alloys.



| J&B # | MFG # | SIZE |              | TYPE | GRADE | MAX RPM | QTY |
|-------|-------|------|--------------|------|-------|---------|-----|
|       |       | DIA  | THK<br>ARBOR |      |       |         |     |
| 39149 | 24160 | 14   | 1/8 x 20mm   | 1    | XFC   | 5,460   | 1   |

---

# ABRASIVE PRODUCTS

## CUBITRON CUT-OFF WHEELS

FOR USE ON PENCIL & DIE GRINDERS



- Cubitron Cut-Off Wheels are designed to provide high cut rates and long life on most all materials including fiberglass, stainless steel, mild steel and aerospace alloys.
- Cubitron Wheels incorporate 3M's patented **Cubitron** ceramic abrasive grain technology and are ideal for use on a wide variety of utility type cut-off tools.



| J&B #  | SIZE     | HOLE | MAX RPM | QTY |
|--------|----------|------|---------|-----|
| *41860 | 3 x 1/16 | 3/8" | 26,000  | 5   |
| *45570 | 4 x 1/32 | 3/8" | 26,250  | 5   |

\*No broken boxes

## CUT-OFF WHEELS

FOR USE ON PENCIL & DIE GRINDERS



- Aluminum oxide grain, hard bond for aggressive cutting on rough applications.
- Easily cuts through tubes, pipes, sheet metal.

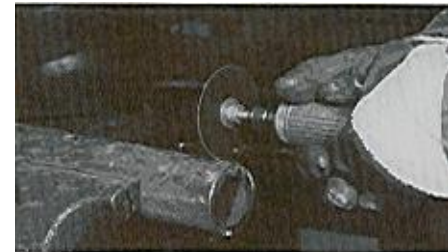

| J&B #  | MFG # | SIZE         | HOLE | MATERIAL | MAX RPM | QTY |
|--------|-------|--------------|------|----------|---------|-----|
| *40249 | F0220 | 2-1/2 x 1/16 | 3/8  | A36T     | 24,446  | 10  |
| 40256  | 23051 | 3 x .035     | 3/8  | A60T     | 25,000  | 10  |
| *42168 | F0310 | 3 x .035     | 3/8  | A60T     | 25,000  | 10  |
| 40250  | 23040 | 3 x 1/16     | 3/8  | A36T     | 25,000  | 10  |
| 40252  | 23065 | 4 x 1/16     | 3/8  | A36T     | 19,000  | 10  |

\* = Flexovit Brand



| J&B # | FITS WHEEL SIZE OF: THICKNESS | ARBOR      | SHANK SIZE | QTY |
|-------|-------------------------------|------------|------------|-----|
| 40255 | .035 to 1/2                   | 3/8        | 1/4        | EA  |
| 40251 | .035 to 3/16                  | 3/8 or 1/4 | 1/4        | EA  |

\* These mandrel adapters fit 2" to 4" diameter wheels.

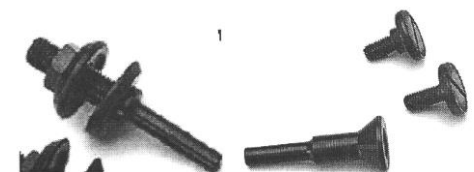

40255

40251



# ABRASIVE PRODUCTS

## CHOPSAW WHEELS

FOR USE ON CHOPSAWS



- General purpose for profiles and solids; carbon or alloy steels.
- Made of reinforced resinoid for longer life.

| J&B # | MFG # | SIZE      | HOLE | MATERIAL | MAX RPM | QTY | CASE |
|-------|-------|-----------|------|----------|---------|-----|------|
| 39062 | 24034 | 12 x 3/32 | 1"   | A30RB    | 5,100   | EA  | 10   |
| 39064 | 24039 | 14 x 3/32 | 1"   | A30RB    | 4,400   | EA  | 10   |

## REDUCING BUSHINGS

- For use with type 1 cut-off wheels.
- Reduces wheel arbor size.

| J&B # | SIZE      | QTY |
|-------|-----------|-----|
| 13757 | 7/8 – 5/8 | 10  |
| 13756 | 1" – 7/8  | 10  |
| 13755 | 1" – 20mm | 10  |



## CIRCULAR SAW WHEELS

FOR USE ON  
CIRCULAR SAWS



- Fast cut metal, stainless.
- A general purpose wheel, ideal on carbon or stainless steel shapes or profiles.
- Provides fast cutting action.

| J&B # | MFG # | SIZE     | HOLE | MATERIAL | MAX RPM | QTY | CASE |
|-------|-------|----------|------|----------|---------|-----|------|
| 45630 | 23230 | 7 x 3/32 | 5/8  | A24R     | 8,500   | EA  | 25   |



# ABRASIVE PRODUCTS

---

## SHOP ROLLS

Aluminum Oxide

FOR HAND USE



- Aluminum oxide abrasive, cloth-backed, glue bonded.
- Comes in handy dispenser box.

| J&B # | GRIT | LENGTH | WIDTH | QTY |
|-------|------|--------|-------|-----|
| 20880 | 60   | 50 YDS | 1-1/2 | EA  |
| 20773 | 80   | 50 YDS | 1-1/2 | EA  |
| 20774 | 100  | 50 YDS | 1-1/2 | EA  |
| 20775 | 120  | 50 YDS | 1-1/2 | EA  |
| 20881 | 150  | 50 YDS | 1-1/2 | EA  |
| 20778 | 180  | 50 YDS | 1-1/2 | EA  |
| 20776 | 240  | 50 YDS | 1-1/2 | EA  |
| 20777 | 320  | 50 YDS | 1-1/2 | EA  |
| 20779 | 400  | 50 YDS | 1-1/2 | EA  |

# ABRASIVE PRODUCTS

---

## ABRASIVE SCREEN

FOR HAND USE



- Made of nylon mesh impregnated with a silicone carbide abrasive.
- Can be used **wet or dry** on metal, wood, and plastic applications.
- Screen mesh design **prevents loading**.
- Can be used on both sides.

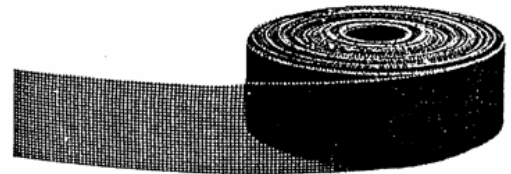

| J&B # | SIZE           | GRIT | QTY |
|-------|----------------|------|-----|
| 20149 | 1-1/2 x 75 Ft. | 120  | EA  |

---

## CROCUS CLOTH ROLL

FOR HAND USE



- Sharp, long lasting aluminum oxide abrasive.
- Excellent for extra **fine polishing** of metals.

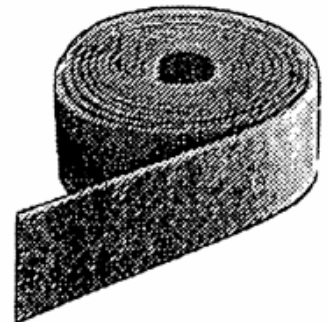

| J&B # | SIZE            | QTY |
|-------|-----------------|-----|
| 20151 | 1-1/2 x 20 Yds. | EA  |

# ABRASIVE PRODUCTS

## PSA SANDING DISCS

### Stikit

- Pressure sensitive adhesive for press-on, peel-off convenience.
- Discs resist loading and reduce “down time”.
- For use on paint, primer, wood, metal and fiberglass.
- All discs below have no holes.

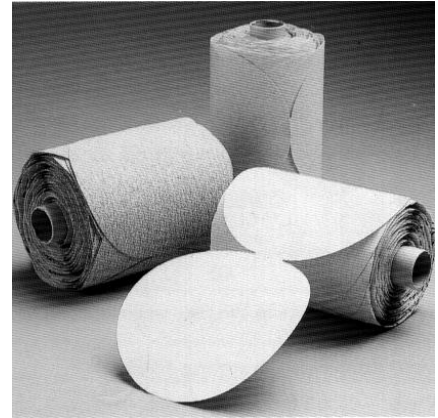

### ORDER BY THE ROLL

| J&B # | 3M #         | COLOR | SIZE | GRIT      | QTY    |
|-------|--------------|-------|------|-----------|--------|
| 40710 | 051144-21799 | GOLD  | 5"   | 80F       | 100/RL |
| 45730 | 35412 (SAIT) | WHITE | 5"   | P120 (6A) | 100/RL |
| 45610 | 35413 (SAIT) | WHITE | 5"   | P150      | 100/RL |

\* Cannot break roll quantity.

ORDER BY THE ROLL

## PSA BACKING PAD

- For use with PSA adhesive backed sanding discs.
- Threaded pad for dual action/random orbital sanders and right angle grinders/sanders.

| J&B # | SIZE        | QTY |
|-------|-------------|-----|
| 41961 | 5 x 5/16-24 | EA  |

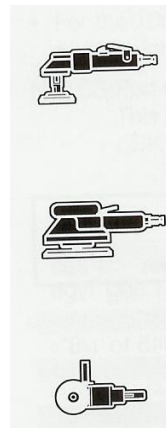

# ABRASIVE PRODUCTS

---

FOR HAND USE

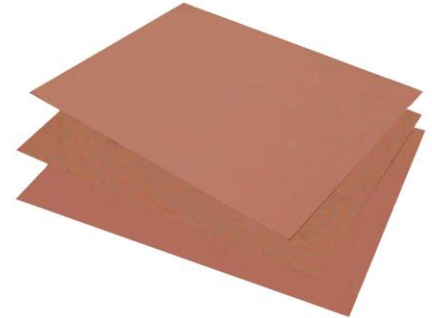

## ALUMINUM OXIDE PAPER Open Coat

- Dry sanding only. Open coat resists loading.
- Effective for removing scratches and burrs on metal, shaping and finishing plastic filler, and stripping old paint or varnish off wood.

| J&B # | SIZE   | GRIT | QTY |
|-------|--------|------|-----|
| 9454  | 9 x 11 | 80D  | 50  |

---

## EMERY CLOTH

- Used for general purpose metal sanding such as light cleanup work and rust removal jobs.

| J&B # | SIZE   | GRIT | QTY |
|-------|--------|------|-----|
| 38058 | 9 x 11 | FINE | EA  |
| 38969 | 9 x 11 | MED  | EA  |

---

## CROCUS CLOTH

- Sharp, long lasting aluminum oxide abrasive.
- Excellent for extra fine polishing of metals.

| J&B # | SIZE   | QTY |
|-------|--------|-----|
| 38968 | 9 x 11 | EA  |

# ABRASIVE PRODUCTS

## TAPERED CARTRIDGE MANDRELS

| J&B # | SHANK DIA. | PILOT LENGTH | PILOT DIA. | QTY |
|-------|------------|--------------|------------|-----|
| 41966 | 1/4"       | 1"           | 1/8        | EA  |
| 41970 | 1/4"       | 1-1/2"       | 3/16       | EA  |



## STEEL WOOL

- Heavy duty grade for removing rust, cleaning car engines & removing accumulations of paint & varnish on floors & furniture.
- Packaged in bags of 12.

| J&B # | GRADE | STYLE        | QTY   |
|-------|-------|--------------|-------|
| 40393 | #4    | EXTRA COARSE | 1 BAG |

(ORDERING 1 = 1 BAG OF 12)

\*\* NO BROKEN BAGS



## STRIP DISC

- Fast, safe removal of surface contaminants.
- Excellent for cleaning welds, removing corrosion, rust, scaling and blending.
- Great for removing paints, varnishes & sealants from Difficult to reach surfaces.

| J&B # | SIZE | MAX RPM | QTY |
|-------|------|---------|-----|
| 45732 | 2"   | 12,000  | 5   |
| 45733 | 3"   | 8,500   | 5   |
| 45960 | 4"   | 12,000  | EA  |

| J&B # | SIZE                | QTY |
|-------|---------------------|-----|
| 40448 | 2" Arbor 1/4" Shank | EA  |
| 40449 | 3" Arbor 1/4" Shank | EA  |



# ABRASIVE PRODUCTS

---

## HUB CLEANING DISC

- Extremely tough non-woven web removes rust & corrosion without excessive metal removal or gouging.
- Contains no wire filaments.
- Ideal for effective removal of buildup on brakes.
- Made of silicon carbide mineral that cuts sharp.
- Disc features a hollow center, enabling operators to slide over and around hub without damaging the stud threads.



| J&B # | SIZE                         | GRIT | STYLE        | QTY |
|-------|------------------------------|------|--------------|-----|
| 49090 | 1-1/2                        | 100  | EXTRA COARSE | 10  |
| 49091 | Holder for hub cleaning disc |      |              | EA  |

---

## FLAP WHEELS

- For cleaning, deburring, finishing, and polishing of flat or contoured metal surfaces.
- Hugs concave or convex surfaces, allowing access to hard-to-reach areas.
- Non-loading; the flexibility provided by the coated abrasive flaps prevents loading which occurs with non-flexible grinding products.
- Arbor has a 1/4-20 thread..



| J&B # | WHEEL DIAMETER | FACE WIDTH | GRIT | MAX RPM | QTY |
|-------|----------------|------------|------|---------|-----|
| 49002 | 2"             | 1"         | 40   | 25,000  | EA  |



# ABRASIVE PRODUCTS

## 3M SCOTCH-BRITE HAND PADS General Purpose Pad

FOR HAND USE



- Made of nylon web - rinse clean – can be used over and over again.
- Handy for doing many chores from cleaning metal surfaces to sanding wood or ceramic materials.
- Use in a dry medium or with lubricants such as water or oil.
- **40650 dark green pads** are general purpose scouring pads (not recommended for use on polished or easily scratched surfaces)

| J&B # | SIZE  | GRIT       | COLOR      | QTY |
|-------|-------|------------|------------|-----|
| 40391 | 6 x 9 | SUPER FINE | WHITE      | 20  |
| 12250 | 6 x 9 | FINE       | LIGHT GRAY | 20  |
| 40700 | 6 x 9 | MEDIUM     | MAROON     | 20  |
| 42063 | 6 x 9 | COARSE     | DARK GRAY  | 20  |
| 40650 | 6 x 9 |            | DARK GREEN | 20  |

\* Sold in full boxes only.

## ALUMINUM OXIDE MOUNTED FLAP WHEELS

- \* For cleaning, deburring, finishing, and polishing of flat or contoured metal surfaces.
- Hugs concave or convex surfaces, allowing access to hard-to-reach areas.
- \* Non-loading; the flexibility provided by the coated abrasive flaps prevents loading which occurs with non-flexible grinding products.
- \* Mandrel mounted on fixed 1/4" solid shank.

FOR USE ON DIE GRINDERS

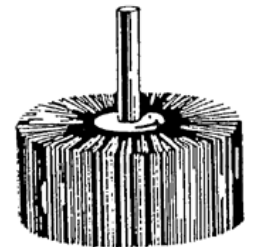

| J&B # | WHEEL DIAMETER | FACE WIDTH | GRIT | MAX RPM | QTY |
|-------|----------------|------------|------|---------|-----|
| 49093 | 1"             | 1"         | 40   | 30,000  | EA  |
| 40654 | 1"             | 1"         | 60   | 30,000  | EA  |
| 40655 | 1"             | 1"         | 80   | 30,000  | EA  |
| 42385 | 1"             | 1"         | 120  | 30,000  | EA  |
| 42387 | 1-1/2"         | 1"         | 60   | 25,000  | EA  |
| 42388 | 1-1/2"         | 1"         | 80   | 25,000  | EA  |
| 40665 | 1-1/2"         | 1"         | 120  | 25,000  | EA  |
| 49094 | 2"             | 1"         | 40   | 25,000  | EA  |
| 42391 | 2"             | 1"         | 60   | 25,000  | EA  |
| 40660 | 2"             | 1"         | 80   | 25,000  | EA  |
| 40662 | 2"             | 1"         | 120  | 25,000  | EA  |
| 40664 | 2"             | 1"         | 180  | 25,000  | EA  |
| 40667 | 2-1/2"         | 1"         | 60   | 23,000  | EA  |
| 42393 | 2-1/2"         | 1"         | 80   | 23,000  | EA  |
| 40668 | 2-1/2"         | 1"         | 120  | 23,000  | EA  |
| 42395 | 3"             | 1"         | 60   | 23,000  | EA  |
| 49095 | 3"             | 1"         | 80   | 23,000  | EA  |
| 42397 | 3"             | 1"         | 120  | 23,000  | EA  |

# ABRASIVE PRODUCTS

## ROL-ON SANDING DISCS

FOR USE ON RIGHT ANGLE SANDERS & GRINDERS



- It is a handy quick change tool for disc grinding.
- Fits any 1/4" drill or air tool.
- Connects quickly and easily to its arbor with a 1/2" right twist and removes with a 1/2" left twist.



| J&B #   | SIZE | GRIT | QTY |
|---------|------|------|-----|
| * 41952 | 2"   | 120  | 50  |
| 38903   | 2"   | 80   | 25  |
| ^ 41945 | 2"   | 80   | 25  |
| * 41981 | 2"   | 80   | 50  |
| 38893   | 2"   | 50   | 25  |
| ^ 41946 | 2"   | 50   | 25  |
| * 41980 | 2"   | 50   | 50  |
| 38894   | 2"   | 36   | 25  |
| ^ 41899 | 2"   | 36   | 25  |
| * 41950 | 2"   | 36   | 50  |
| 38895   | 2"   | 24   | 25  |
| ^ 41901 | 2"   | 24   | 25  |
| * 41979 | 2"   | 24   | 50  |
| 39029   | 3"   | 120  | 25  |
| 38966   | 3"   | 80   | 25  |
| * 41985 | 3"   | 50   | 50  |
| 38896   | 3"   | 50   | 25  |
| * 41986 | 3"   | 36   | 50  |
| 38897   | 3"   | 36   | 25  |
| * 41987 | 3"   | 24   | 50  |
| 38898   | 3"   | 24   | 25  |

| J&B # | SIZE                | QTY |
|-------|---------------------|-----|
| 40448 | 2" Arbor 1/4" Shank | EA  |
| 40449 | 3" Arbor 1/4" Shank | EA  |

\* 3M discs.

^ Shark discs.

## ROL-ON BRISTLE DISCS

- Ideal for cleaning, finishing, blending and deburring.
- Used on corners, welds and for rivet cleaning on all areas where conformability is required.
- Eliminate dangerous flying wires.

| J&B # | SIZE | GRIT   | COLOR  | QTY |
|-------|------|--------|--------|-----|
| 42164 | 2"   | FINE   | WHITE  | 5   |
| 42160 | 2"   | MEDIUM | YELLOW | 5   |
| 42162 | 2"   | COARSE | GREEN  | 5   |
| 43236 | 3"   | MEDIUM | YELLOW | 5   |
| 42163 | 3"   | COARSE | GREEN  | 5   |



\*Use arbor 40448 for 2" bristle disc & 40449 for 3".

# ABRASIVE PRODUCTS

## TRIM-KUT DISCS

FOR USE ON RIGHT ANGLE SANDERS & GRINDERS

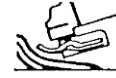

- Trim-Kut abrasive discs are a unique one piece design with the grinding surface bonded to a hard copolymer backing.
- No backing pad required.
- Grinds, sands, levels weld seams and is an excellent rust/paint remover.
- Aluminum oxide discs.

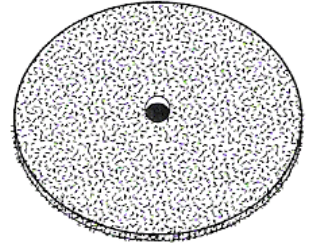

| J&B # | SIZE | PRINT COLOR | GRIT | QTY |
|-------|------|-------------|------|-----|
| 20441 | 3"   | WHITE       | 24   | 25  |
| 20442 | 3"   | RED         | 36   | 25  |
| 20443 | 3"   | ORANGE      | 60   | 25  |
| 20444 | 3"   | GREEN       | 120  | 25  |

\* All boxes contain 1 mandrel.

### HEX PREMIUM MANDREL

| J&B # | SIZE | QTY |
|-------|------|-----|
| 20450 | 1/4" | EA  |

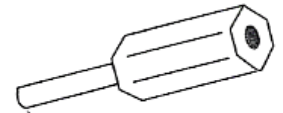

## MINI FLAP DISCS

- Long life performance of a flap disc for use in confined spaces.
- More material, longer life than a single layer laminated disc.
- Roloc style allows easy changeover.



| J&B # | SIZE                  | GRIT | QTY |
|-------|-----------------------|------|-----|
| 59114 | 2"                    | 40   | EA  |
| 59115 | 2"                    | 80   | EA  |
| 59117 | 3"                    | 40   | EA  |
| 59118 | 3"                    | 80   | EA  |
| 40448 | 2" Arbor (1/4" shank) |      | EA  |
| 40449 | 3" Arbor (1/4" shank) |      | EA  |

# ABRASIVE PRODUCTS

## ROLON SURFACE CONDITIONING DISCS

FOR USE ON RIGHT ANGLE SANDERS & GRINDERS



- Non-woven surface conditioning products are ideal for deburring, cleaning, blending, and polishing.
- Use on mild steel, stainless, aluminum, plastic or wood.
- Connects quickly and easily to its arbor with a 1/2 right twist and removes with a 1/2 left twist.



| J&B #    | SIZE                  | GRIT   | COLOR  | QTY |
|----------|-----------------------|--------|--------|-----|
| 38899    | 2"                    | FINE   | BLUE   | 25  |
| ^ 41988  | 2"                    | FINE   | BLUE   | 25  |
| 40440    | 2"                    | MEDIUM | MAROON | 25  |
| ^ 41893  | 2"                    | MEDIUM | MAROON | 25  |
| ^ 41894  | 2"                    | MEDIUM | MAROON | 50  |
| ** 20449 | 2"                    | MEDIUM | MAROON | 50  |
| 40442    | 2"                    | COARSE | BROWN  | 25  |
| ^ 41895  | 2"                    | COARSE | BROWN  | 25  |
| ^ 41896  | 2"                    | COARSE | BROWN  | 50  |
| ** 20448 | 2"                    | COARSE | BROWN  | 50  |
| 38900    | 3"                    | FINE   | BLUE   | 25  |
| ^ 41932  | 3"                    | FINE   | BLUE   | 25  |
| 40444    | 3"                    | MEDIUM | MAROON | 25  |
| ^ 41897  | 3"                    | MEDIUM | MAROON | 25  |
| 40446    | 3"                    | COARSE | BROWN  | 25  |
| ^ 41898  | 3"                    | COARSE | BROWN  | 25  |
| 40448    | 2" Arbor (1/4" shank) |        |        | EA  |
| 40449    | 3" Arbor (1/4" shank) |        |        | EA  |

\*\* GEMTEX

^ SHARK

## VELCRO SURFACE CONDITIONING DISCS

FOR USE ON RIGHT ANGLE SANDERS & GRINDERS



- Non-woven surface conditioning products are ideal for deburring, cleaning, blending, and polishing.
- Use on mild steel, stainless, aluminum, plastic or wood.
- This disc pad connects quickly and easily to any power tool while holding surface conditioning discs securely and safely through the use of dual lock fastening system.



| J&B # | SIZE                  | GRIT   | COLOR  | QTY |
|-------|-----------------------|--------|--------|-----|
| 40420 | 2"                    | MEDIUM | MAROON | 25  |
| 40422 | 2"                    | COARSE | BROWN  | 25  |
| 40430 | 2" Arbor (1/4" shank) |        |        | EA  |

# ABRASIVE PRODUCTS

## INTERLEAF WHEELS

- Mandrel mounted on fixed 1/4" solid shank.
- Medium grade. Excellent for removing heavy oxidation, blending, cleaning and deburring.
- Very fine grade. Excellent for grain finishing, satin finishing and linear scratch patterns.



| J&B # | DIA x THICKNESS | GRIT | GRADE     | MAX RPM | QTY |
|-------|-----------------|------|-----------|---------|-----|
| 46130 | 2 x 1           | 60   | MEDIUM    | 15,000  | EA  |
| 46131 | 2 x 1           | 80   | MEDIUM    | 15,000  | EA  |
| 46132 | 2 x 1           | 120  | VERY FINE | 15,000  | EA  |

## NON WOVEN SURFACE CONDITIONING DISCS

### Hook & Loop

FOR USE ON RIGHT ANGLE GRINDERS



- Ideal for deburring, cleaning, blending and polishing.
- Use on mild steel, stainless, aluminum, plastic or wood.
- Gripper pad is made perfectly flat from high impact plastics to ensure maximum support and disc adhesion.

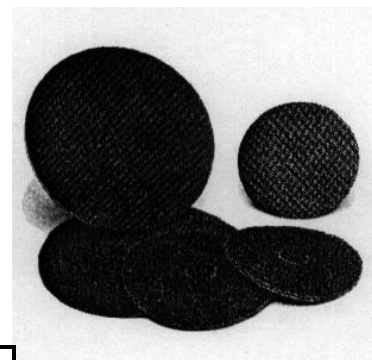

| J&B # | SIZE                           | GRIT   | COLOR | QTY |
|-------|--------------------------------|--------|-------|-----|
| 45680 | 7"                             | FINE   | BLUE  | 10  |
| 45682 | 7"                             | COARSE | BROWN | 10  |
| 45683 | 7" Gripper Pad (5/8-11" shank) |        |       | EA  |

## ROLOC UNITIZED WHEEL

- Roloc unitized wheels are strong, efficient products for edge deburring and finishing.
- They perform well in a variety of metal working applications and on intricate machined parts where close tolerances are important.
- The Roloc holding systems make changing unitized wheels quick and easy.



| J&B # | SIZE                  | GRIT   | COLOR | QTY |
|-------|-----------------------|--------|-------|-----|
| 40477 | 2"                    | MEDIUM | TAN   | 5   |
| 40448 | 2" Arbor (1/4" shank) |        |       | EA  |



# ABRASIVE PRODUCTS

## MOUNTED GRINDING STONES

Premium Quality

FOR USE ON DIE GRINDERS



- Aluminum oxide vitrified bonded wheels are for all kinds of grinding, deburring, blending and contouring of ferrous and non-ferrous metals.
- Different shapes give access to hard-to-reach areas.



# 40680  
(IND. # A3)



# 40681  
(IND. # A11)



# 40682  
(IND. # A21)

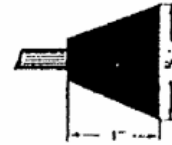

# 40683  
(IND. # A31)



# 40684  
(IND. # A36)



# 40685  
(IND. # B52)



# 40686  
(IND. # W163)



# 40687  
(IND. # W185)

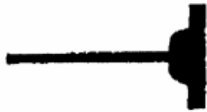

# 40688  
(IND. # W215)



# 40689  
(IND. # W220)



# 40690  
(IND. # W235)



# 40691  
(IND. # W236)

| J&B # | IND # | ABRASIVE SHAPE |       | MANDREL SIZE | MAX RPM | QTY |
|-------|-------|----------------|-------|--------------|---------|-----|
|       |       | DIAM           | THICK |              |         |     |
| 40680 | A3    | 1              | 2-3/4 | 1/4          | 16,100  | 2   |
| 40681 | A11   | 7/8            | 2     | 1/4          | 19,860  | 2   |
| 40682 | A21   | 1              | 1     | 1/4          | 34,500  | 2   |
| 40683 | A31   | 1-3/8          | 1     | 1/4          | 27,780  | 2   |
| 40684 | A36   | 1-5/8          | 3/8   | 1/4          | 23,520  | 2   |
| 40685 | B52   | 3/8            | 3/4   | 1/8          | 45,370  | 2   |
| 40686 | W163  | 1/4            | 1/2   | 1/8          | 60,000  | 2   |
| 40687 | W185  | 1/2            | 1/2   | 1/8          | 34,500  | 2   |
| 40688 | W215  | 1              | 1/8   | 1/8          | 38,200  | 2   |
| 40689 | W220  | 1              | 1     | 1/4          | 25,500  | 2   |
| 40690 | W235  | 1-1/2          | 1/4   | 1/4          | 25,470  | 2   |
| 40691 | W236  | 1-1/2          | 1/2   | 1/4          | 25,470  | 2   |

**GROUP A SHAPES:** Use for medium to heavy duty blending and contouring.

**GROUP B SHAPES:** Best for light deburring and blending.

**GROUP W SHAPES:** Suited for off-handed and precision grinding where medium to heavy stock removal is required.





# ABRASIVE PRODUCTS

## WIRE END BRUSHES

FOR USE ON STRAIGHT GRINDERS

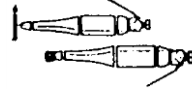

- Use crimped for softer and knotted for more aggressive brushing.
- Use with portable tools or drill presses.
- Ideal for tight to get at areas and blind holes.



### APPLICATIONS:

- Carbon Cleaning
- Die, Mold and Tool Polishing
- Rust or Paint Removal
- Burr Removal
- Weld Cleaning
- Rubber or Plastic Removal
- Spot Facing
- Cleaning Castings

42120 / 20960 /  
20961  
CRIMPED

45702 /  
41192  
KNOTTED

| J&B # | DIA    | SHANK | WIRE SIZE | TRIM LENGTH | MAX. SAFE FREE SPEED (RPM) | QTY |
|-------|--------|-------|-----------|-------------|----------------------------|-----|
| 20960 | 1/2"   | 1/4"  | .020      | 1"          | 22,000                     | EA  |
| 20961 | 1"     | 1/4"  | .020      | 1"          | 20,000                     | EA  |
| 42120 | 1-3/4" | 1/4"  | .012      | 1"          | 20,000                     | EA  |
| 45702 | 3/4"   | 1/4"  | .014      | 1"          | 20,000                     | EA  |
| 41192 | 1-1/8" | 1/4"  | .020      | 1"          | 20,000                     | EA  |

## TUBE BRUSH

- Deburring and cleaning drilled holes and internal threads, cleaning and finishing internal diameters of pipes and tubes, deburring and cleaning keyways and grooves.

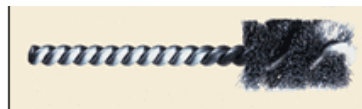

| J&B # | DIA  | BRUSH LENGTH | OVERALL LENGTH | FILAMENT/ DIAMETER | QTY |
|-------|------|--------------|----------------|--------------------|-----|
| 41326 | 7/8" | 1"           | 3-1/2"         | .006 CARBON        | EA  |

# ABRASIVE PRODUCTS

## KNOT WIRE CUP BRUSH

FOR USE ON ANGLE GRINDERS



- Knot wheels provide high impact brushing action for heavy surface conditioning applications.

| J&B #  | DIA    | ARBOR  | WIRE SIZE | MATERIAL | MAX. SAFE FREE SPEED (RPM) | QTY |
|--------|--------|--------|-----------|----------|----------------------------|-----|
| V41877 | 2-3/4" | 5/8-11 | .020      | Carbon   | 14,000                     | EA  |
| 41790  | 3-1/2" | 5/8-11 | .020      | Carbon   | 12,500                     | EA  |
| 41193  | 4"     | 5/8-11 | .020      | Carbon   | 9,000                      | EA  |

## LARGE CRIMPED WIRE CUP BRUSH

FOR USE ON LARGE ANGLE GRINDERS



- For general purpose cleaning and deburring.
- Ideal for light cleaning and paint removal.
- Ideal for flat surfaces and edge cleaning.

| J&B # | DIA    | ARBOR  | WIRE SIZE | MATERIAL | MAX. SAFE FREE SPEED (RPM) | QTY |
|-------|--------|--------|-----------|----------|----------------------------|-----|
| 41791 | 2-3/4" | 5/8-11 | .014      | Carbon   | 14,000                     | EA  |
| 41872 | 3-1/2" | 5/8-11 | .014      | Carbon   | 12,500                     | EA  |

## CRIMPED WIRE CUP BRUSH

FOR USE ON DIE GRINDERS, POWER DRILLS, RIGHT ANGLE AIR DIE GRINDERS



| J&B # | DIA | ARBOR | WIRE SIZE | MATERIAL | MAX. SAFE FREE SPEED (RPM) | QTY |
|-------|-----|-------|-----------|----------|----------------------------|-----|
| 45729 | 2"  | 1/4"  | .0118     | Carbon   | 13,000                     | EA  |

# ABRASIVE PRODUCTS

## KNOT WIRE CUP BRUSH Stainless Steel

FOR USE ON ANGLE GRINDERS



- Knot wheels provide high impact brushing action for heavy surface conditioning applications.
- For applications where contamination of the workpiece is a concern. Manufactured with 302 stainless.

| J&B # | DIA    | ARBOR  | WIRE SIZE | MATERIAL  | MAX. SAFE FREE SPEED (RPM) | QTY |
|-------|--------|--------|-----------|-----------|----------------------------|-----|
| 48710 | 2-3/4" | 5/8-11 | .020      | Stainless | 12,500                     | EA  |
| 48711 | 3-1/2" | 5/8-11 | .020      | Stainless | 12,500                     | EA  |

## LARGE CRIMPED WIRE CUP BRUSH Stainless Steel

FOR USE ON LARGE ANGLE GRINDERS



- For general purpose cleaning and deburring.
- Ideal for light cleaning and paint removal.
- Ideal for flat surfaces and edge cleaning.
- For applications where contamination of the workpiece is a concern. Manufactured with 302 stainless.

| J&B # | DIA    | ARBOR  | WIRE SIZE | MATERIAL  | MAX. SAFE FREE SPEED (RPM) | QTY |
|-------|--------|--------|-----------|-----------|----------------------------|-----|
| 48715 | 2-3/4" | 5/8-11 | .014      | Stainless | 12,00                      | EA  |
| 48716 | 3-1/2" | 5/8-11 | .014      | Stainless | 12,500                     | EA  |

# ABRASIVE PRODUCTS

## CRIMPED WIRE WHEEL

FOR USE ON ANGLE GRINDERS



- For light rust and oxide removal, cleaning and conditioning.
- Crimped wire wheel brushes have higher flexibility than knotted wire for application on irregular surfaces and where lighter brushing is required.

| J&B # | DIAM | FACE | ARBOR  | WIRE SIZE | MAX. SAFE FREE SPEED (RPM) | QTY |
|-------|------|------|--------|-----------|----------------------------|-----|
| 40433 | 4"   | 1/2" | 5/8-11 | .014      | 15,000                     | EA  |

## KNOTTED WIRE WHEEL

FOR USE ON ANGLE GRINDERS



- Provide high impact action to remove weld scale and splatter.
- Ideal for general cleaning.

| J&B # | DIAM | FACE | ARBOR  | WIRE SIZE | MAX. SAFE FREE SPEED (RPM) | QTY |
|-------|------|------|--------|-----------|----------------------------|-----|
| 40434 | 4"   | 3/8" | 5/8-11 | .020      | 20,000                     | EA  |
| 46442 | 6"   | 1/2" | 5/8-11 | .023      | 9,000                      | EA  |

# ABRASIVE PRODUCTS

## KNOTTED WIRE WHEEL

FOR USE ON RIGHT ANGLE SANDERS & GRINDERS



- Cleaning, deburring, roughening.

| J&B # | DIAM | FACE | ARBOR | WIRE SIZE | MAX. SAFE FREE SPEED (RPM) | QTY |
|-------|------|------|-------|-----------|----------------------------|-----|
| 45731 | 3"   | 3/8" | 1/4"  | .014      | 25,000                     | EA  |
| 49092 | 4"   | 5/8" | 1/4"  | .020      | 20,000                     | EA  |

## CRIMPED WIRE WHEEL

FOR USE ON RIGHT ANGLE SANDERS & GRINDERS



- For light to medium duty applications

### Hex Arbor

| J&B # | DIAM | THICK | ARBOR | WIRE SIZE | MAX RPM | QTY |
|-------|------|-------|-------|-----------|---------|-----|
| 38667 | 2"   | 3/8   | 1/4"  | .012      | 5,000   | EA  |
| 38668 | 3"   | 3/8   | 1/4"  | .012      | 4,500   | EA  |
| 38669 | 3"   | 3/8   | 1/4"  | .008      | 4,500   | EA  |
| 38665 | 4"   | 1/2"  | 1/4"  | .012      | 4,500   | EA  |



### Smooth Arbor

| J&B # | DIAM   | THICK | ARBOR | WIRE SIZE | MAX RPM | QTY |
|-------|--------|-------|-------|-----------|---------|-----|
| 38666 | 1-1/2" | 3/8   | 1/4"  | .012      | 20,000  | EA  |
| 43012 | 2"     | 3/8   | 1/4"  | .012      | 20,000  | EA  |
| 43013 | 3"     | 1/2   | 1/4"  | .008      | 20,000  | EA  |
| 43014 | 3"     | 1/2   | 1/4"  | .014      | 20,000  | EA  |



# ABRASIVE PRODUCTS

## CRIMPED WIRE WHEELS

Carbon Steel

FOR USE ON BENCH GRINDERS

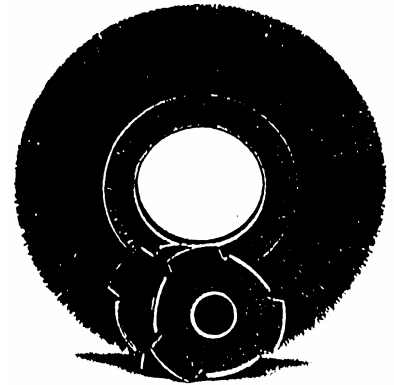

- Designed for maximum productivity; good filament density and additional section construction for extra rigidity.
- Excellent for refining metal surfaces, preparing rubber in vulcanizing, blending surfaces, removing light burrs, paint and corrosion.

| J&B # | DIAM. | WIRE SIZE | WIDTH | ARBOR    | MAX RPM | QTY |
|-------|-------|-----------|-------|----------|---------|-----|
| 39175 | 6"    | .014      | 1/2"  | 1/2, 5/8 | 6,000   | EA  |
| 39094 | 8"    | .014      | 1"    | 1/2, 5/8 | 4,500   | EA  |

\* Part #39094 comes with 1/2 and 5/8 arbor;  
3/4 arbor must be ordered separately.

| J&B # | ARBOR                |
|-------|----------------------|
| 1403  | 3/4 - (for 8" wheel) |

## T-C CARBON STEEL WHEELS

FOR USE ON MINI GRINDERS



- Designed for use in restricted or hard-to-reach areas.
- Used for deburring, blending and cleaning of surfaces.

| J&B # | DIAM.  | WIRE SIZE | WIDTH | ARBOR | MAX RPM | QTY |
|-------|--------|-----------|-------|-------|---------|-----|
| 40141 | 2"     | .012      | 1/4   | 1/2   | 20,000  | EA  |
| 40142 | 2-1/2" | .014      | 1/4   | 1/2   | 20,000  | EA  |
| 40143 | 3"     | .012      | 1/4   | 1/2   | 20,000  | EA  |

## ARBOR



Metal arbor for use in portable tools and drill presses with 1/4" capacity chucks 1/4" shank, 1/2" diameter brush to be used in adapting small diameter brushes with 1/2" diameter hole. **DO NOT USE WITH GRINDING WHEELS.**

| J&B # | QTY |
|-------|-----|
| 40140 | EA  |





# ABRASIVE PRODUCTS

## DREMEL PRODUCTS

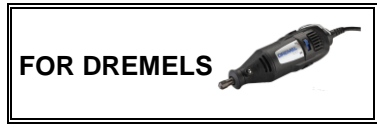

- All products used on Dremel tool and designed to get into hard to reach surfaces.

| J&B # | DESCRIPTION                           | DREMEL # | QTY  |
|-------|---------------------------------------|----------|------|
| 40417 | 3/4" diameter; wire carbon steel      | 428-02   | 2/PK |
| 40418 | 3/4" diameter; wire brass             | 535-02   | 2/PK |
| 40419 | 3/4" diameter; wire stainless steel   | 530-02   | 2/PK |
| 40421 | 1/8" diameter; wire carbon steel      | 443-02   | 2/PK |
| 40423 | 1/2" diameter; wire carbon steel      | 442-02   | 2/PK |
| 40425 | 3/16 diameter; 80 grit flap wheel     | 504      | EA   |
| 40427 | 3/8" diameter; 80 grit flap wheel     | 502      | EA   |
| 40428 | 1/2" diameter; silicone carbide       | 520-02   | 2/PK |
| 40429 | 5/8" diameter; aluminum oxide         | 8193     | EA   |
| 40431 | 1/4" diameter; 60 grit aluminum oxide | 430      | EA   |

\* 2 packs cannot be broken.

\* Ordering 1 40417, 40418, 40419, 40421, 40423 or 40428 will get 1 pack of 2.

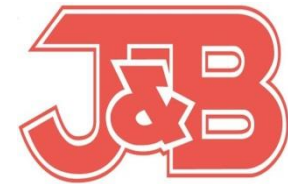
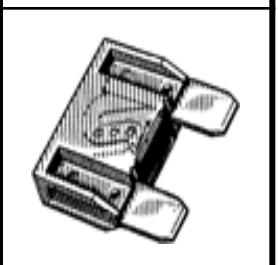
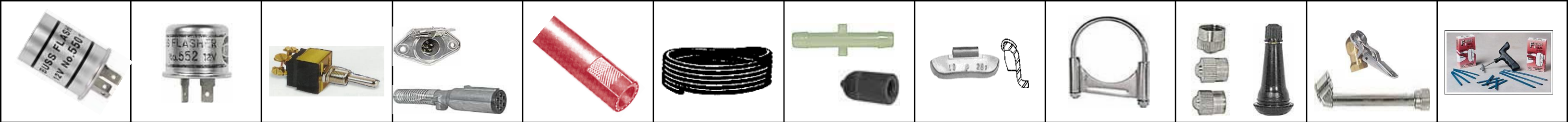

**PART# 2851**

**J&B Fleet - Industrial Supply**

22428 Harrisburg-Westville Rd. Alliance, Ohio 44601 Phone: (330) 821-6342 Fax: (330) 821-0411

[www.jbfleet.com](http://www.jbfleet.com)

**2" SANDING DISCS**

**41979**

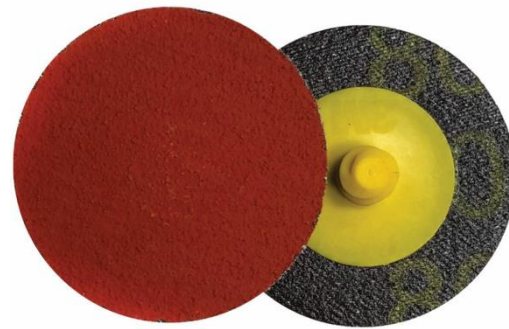

**2" 24 GRIT**

10

**41950**

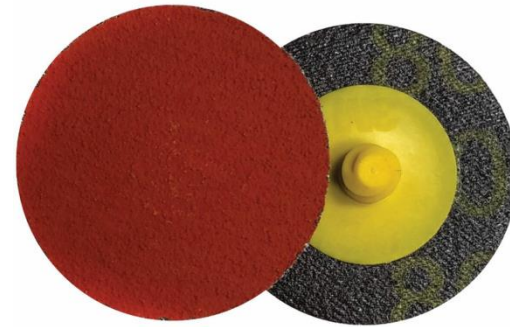

**2" 36 GRIT**

10

**41980**

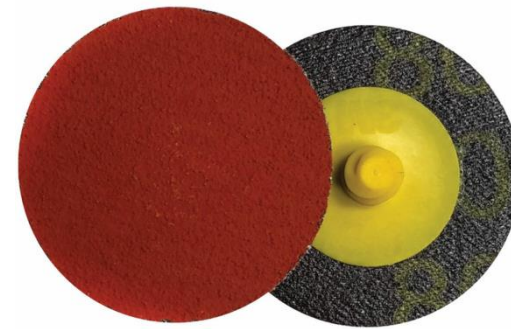

**2" 50 GRIT**

10

**41981**

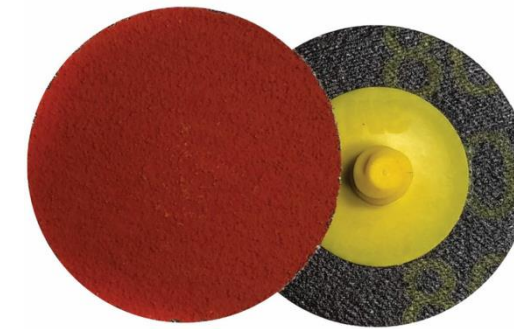

**2" 80 GRIT**

10

**41952**

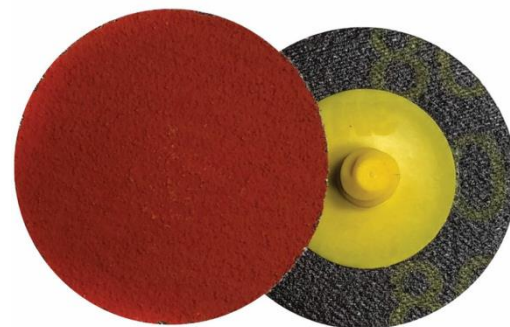

**2" 120 GRIT**

10

**40448**



**2" ARBOR**

1





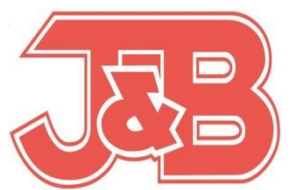
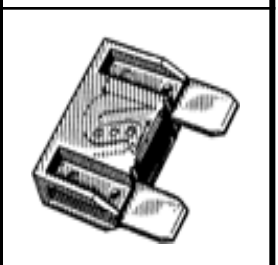

**PART# 2852**

**J&B Fleet - Industrial Supply**

22428 Harrisburg-Westville Rd. Alliance, Ohio 44601 Phone: (330) 821-6342 Fax: (330) 821-0411

[www.jbfleet.com](http://www.jbfleet.com)

**2" SANDING DISCS**

|                                                         |                                                        |                                                        |                                                        |
|---------------------------------------------------------|--------------------------------------------------------|--------------------------------------------------------|--------------------------------------------------------|
| <p><b>38895</b></p> <p><b>2" 24 GRIT</b></p> <p>10</p>  | <p><b>38894</b></p> <p><b>2" 36 GRIT</b></p> <p>10</p> | <p><b>38893</b></p> <p><b>2" 50 GRIT</b></p> <p>10</p> | <p><b>38903</b></p> <p><b>2" 80 GRIT</b></p> <p>10</p> |
| <p><b>41952</b></p> <p><b>2" 120 GRIT</b></p> <p>10</p> |                                                        |                                                        | <p><b>40448</b></p> <p><b>2" ARBOR</b></p> <p>1</p>    |



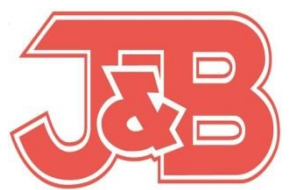
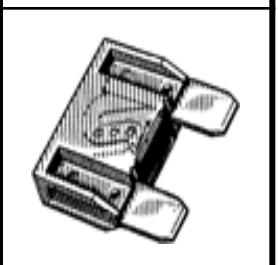
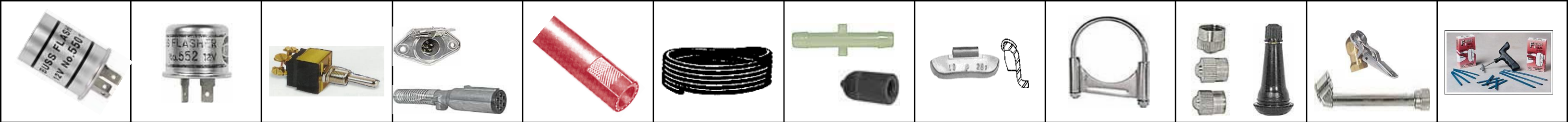



**PART# 2853**

**J&B Fleet - Industrial Supply**

22428 Harrisburg-Westville Rd. Alliance, Ohio 44601 Phone: (330) 821-6342 Fax: (330) 821-0411

[www.jbfleet.com](http://www.jbfleet.com)

**3" SANDING DISCS**

|                                                                                                                                                                                                                                         |                                                                                                                                                                                                                                          |                                                                                                                                                                                                                                           |                                                                                                                                                                                                                                                                                                                                                                                                                                                                               |
|-----------------------------------------------------------------------------------------------------------------------------------------------------------------------------------------------------------------------------------------|------------------------------------------------------------------------------------------------------------------------------------------------------------------------------------------------------------------------------------------|-------------------------------------------------------------------------------------------------------------------------------------------------------------------------------------------------------------------------------------------|-------------------------------------------------------------------------------------------------------------------------------------------------------------------------------------------------------------------------------------------------------------------------------------------------------------------------------------------------------------------------------------------------------------------------------------------------------------------------------|
| <p style="text-align: center;"><b>38898</b></p>  <p style="text-align: center;"><b>3"</b><br/><b>24 GRIT</b></p> <p style="text-align: center;">10</p> | <p style="text-align: center;"><b>38897</b></p>  <p style="text-align: center;"><b>3"</b><br/><b>36 GRIT</b></p> <p style="text-align: center;">10</p> | <p style="text-align: center;"><b>38896</b></p>  <p style="text-align: center;"><b>3"</b><br/><b>50 GRIT</b></p> <p style="text-align: center;">10</p> | <p style="text-align: center;"><b>38966</b></p>  <p style="text-align: center;"><b>3"</b><br/><b>80 GRIT</b></p> <p style="text-align: center;">10</p> <hr/> <p style="text-align: center;"><b>40449</b></p>  <p style="text-align: center;"><b>3" ARBOR</b></p> <p style="text-align: center;">1</p> |
|-----------------------------------------------------------------------------------------------------------------------------------------------------------------------------------------------------------------------------------------|------------------------------------------------------------------------------------------------------------------------------------------------------------------------------------------------------------------------------------------|-------------------------------------------------------------------------------------------------------------------------------------------------------------------------------------------------------------------------------------------|-------------------------------------------------------------------------------------------------------------------------------------------------------------------------------------------------------------------------------------------------------------------------------------------------------------------------------------------------------------------------------------------------------------------------------------------------------------------------------|





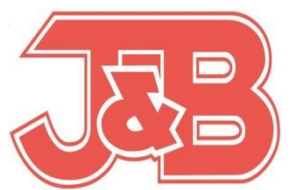
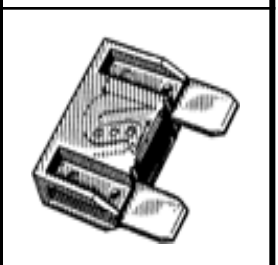



**PART# 2854**

**J&B Fleet - Industrial Supply**

22428 Harrisburg-Westville Rd. Alliance, Ohio 44601 Phone: (330) 821-6342 Fax: (330) 821-0411

[www.jbfleet.com](http://www.jbfleet.com)

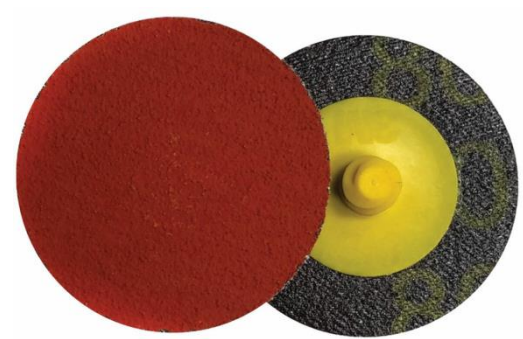
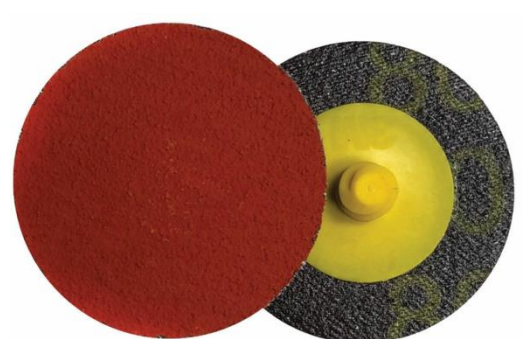
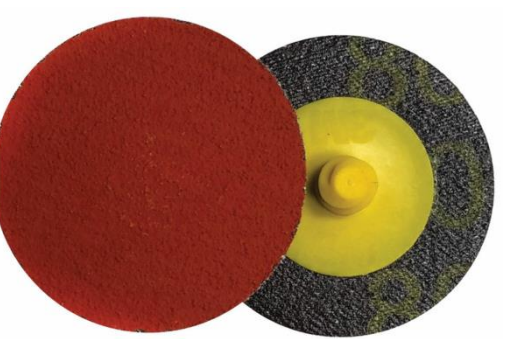
**3" SANDING DISCS**

|                                                                                                                                                                                                                                         |                                                                                                                                                                                                                                           |                                                                                                                                                                                                                                           |                                                                                                                                                                                                                                                                                                                                                                                                                                                                               |
|-----------------------------------------------------------------------------------------------------------------------------------------------------------------------------------------------------------------------------------------|-------------------------------------------------------------------------------------------------------------------------------------------------------------------------------------------------------------------------------------------|-------------------------------------------------------------------------------------------------------------------------------------------------------------------------------------------------------------------------------------------|-------------------------------------------------------------------------------------------------------------------------------------------------------------------------------------------------------------------------------------------------------------------------------------------------------------------------------------------------------------------------------------------------------------------------------------------------------------------------------|
| <p style="text-align: center;"><b>41987</b></p>  <p style="text-align: center;"><b>3"</b><br/><b>24 GRIT</b></p> <p style="text-align: center;">10</p> | <p style="text-align: center;"><b>41986</b></p>  <p style="text-align: center;"><b>3"</b><br/><b>36 GRIT</b></p> <p style="text-align: center;">10</p> | <p style="text-align: center;"><b>41985</b></p>  <p style="text-align: center;"><b>3"</b><br/><b>50 GRIT</b></p> <p style="text-align: center;">10</p> | <p style="text-align: center;"><b>38966</b></p>  <p style="text-align: center;"><b>3"</b><br/><b>80 GRIT</b></p> <p style="text-align: center;">10</p> <hr/> <p style="text-align: center;"><b>40449</b></p>  <p style="text-align: center;"><b>3" ARBOR</b></p> <p style="text-align: center;">1</p> |
|-----------------------------------------------------------------------------------------------------------------------------------------------------------------------------------------------------------------------------------------|-------------------------------------------------------------------------------------------------------------------------------------------------------------------------------------------------------------------------------------------|-------------------------------------------------------------------------------------------------------------------------------------------------------------------------------------------------------------------------------------------|-------------------------------------------------------------------------------------------------------------------------------------------------------------------------------------------------------------------------------------------------------------------------------------------------------------------------------------------------------------------------------------------------------------------------------------------------------------------------------|



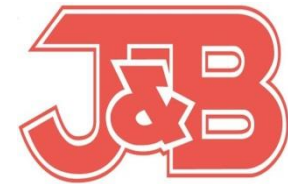
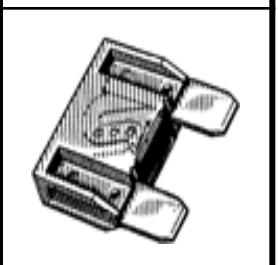
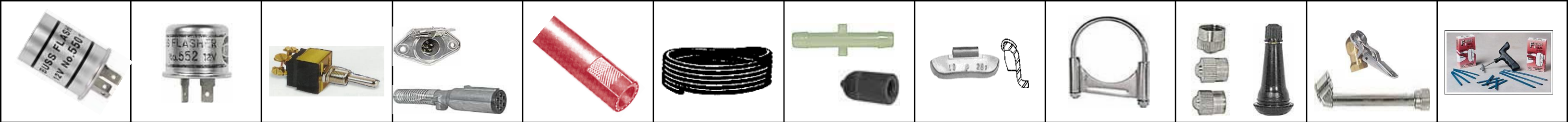

**PART# 2855**

**J&B Fleet - Industrial Supply**

22428 Harrisburg-Westville Rd. Alliance, Ohio 44601 Phone: (330) 821-6342 Fax: (330) 821-0411

[www.jbfleet.com](http://www.jbfleet.com)

**BRISTLE DISCS**

**42163**



**3" COARSE GREEN**

2

**42162**



**2" COARSE GREEN**

3

**42160**



**2" MEDIUM YELLOW**

3

**43236**



**3" MEDIUM YELLOW**

2

**42164**



**2" FINE WHITE**

3

**40448**



**2" ARBOR**

1

**40449**



**3" ARBOR**

1





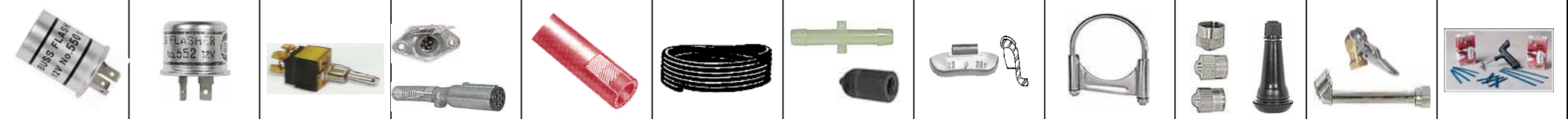





# J&B Fleet - Industrial Supply

www.jbfleet.com

22428 Harrisburg-Westville Rd. Alliance, Ohio 44601 Phone: (330) 821-6342 Fax: (330) 821-0411

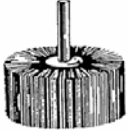
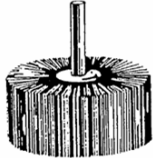
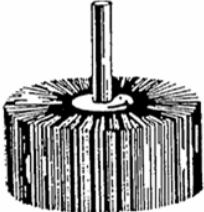
PART # 2202

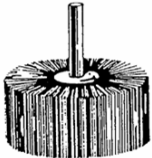
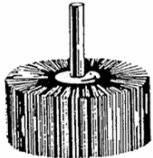
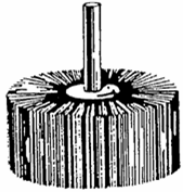
## FLAP WHEELS

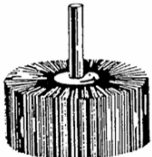
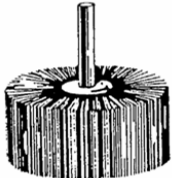
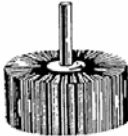
|                                                                                                                                         |                                                                                                                                       |                                                                                                                                           |                                                                                                                                       |
|-----------------------------------------------------------------------------------------------------------------------------------------|---------------------------------------------------------------------------------------------------------------------------------------|-------------------------------------------------------------------------------------------------------------------------------------------|---------------------------------------------------------------------------------------------------------------------------------------|
| <p><b>40654</b></p>  <p>1<br/>1" DIA 60 GRIT</p>       | <p><b>42388</b></p>  <p>1<br/>1-1/2" DIA 80 GRIT</p> | <p><b>40662</b></p>  <p>1<br/>2" DIA 120 GRIT</p>      | <p><b>42395</b></p>  <p>1<br/>3" DIA 60 GRIT</p>   |
| <p><b>40655</b></p>  <p>1<br/>1" DIA 80 GRIT</p>       | <p><b>42391</b></p>  <p>1<br/>2" DIA 60 GRIT</p>     | <p><b>40664</b></p>  <p>1<br/>2" DIA 180 GRIT</p>      | <p><b>42397</b></p>  <p>1<br/>3" DIA 120 GRIT</p> |
| <p><b>42385</b></p>  <p>1<br/>1" DIA 120 GRIT</p>      | <p><b>40660</b></p>  <p>1<br/>2" DIA 80 GRIT</p>   | <p><b>42393</b></p>  <p>1<br/>2-1/2" DIA 80 GRIT</p> |                                                                                                                                       |
| <p><b>42387</b></p>  <p>1<br/>1-1/2" DIA 60 GRIT</p> |                                                                                                                                       |                                                                                                                                           |                                                                                                                                       |



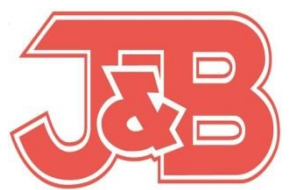
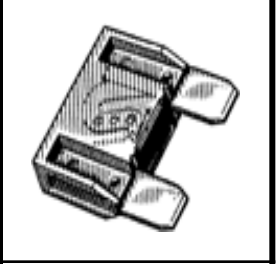
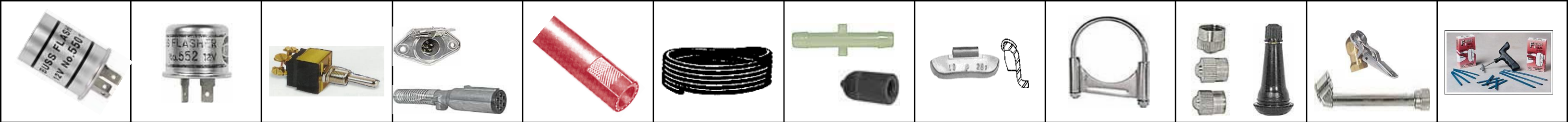

**PART# 2856**

**J&B Fleet - Industrial Supply**

22428 Harrisburg-Westville Rd. Alliance, Ohio 44601 Phone: (330) 821-6342 Fax: (330) 821-0411

[www.jbfleet.com](http://www.jbfleet.com)

**MINI FLAP DISCS**

**59114**

**2" 40 GRIT**

3

**59117**

**3" 40 GRIT**

3

**59118**

**3" 80 GRIT**

3

**59115**

**2" 80 GRIT**

3

**40449**

**3" ARBOR**

1

**40448**

**2" ARBOR**

1

**40448**

**2" ARBOR**

1





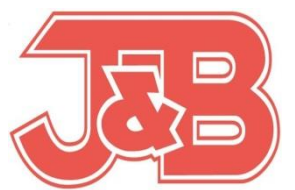





**PART# 2857**

**J&B Fleet - Industrial Supply**

22428 Harrisburg-Westville Rd. Alliance, Ohio 44601 Phone: (330) 821-6342 Fax: (330) 821-0411

[www.jbfleet.com](http://www.jbfleet.com)

**TRIM-KUT DISCS**

|                                                                                                                                                                                                                                                          |                                                                                                                                                                                                                                                         |                                                                                                                                                                                                                                                             |                                                                                                                                                                                                                                                                                                                                                                                                                                                                                              |
|----------------------------------------------------------------------------------------------------------------------------------------------------------------------------------------------------------------------------------------------------------|---------------------------------------------------------------------------------------------------------------------------------------------------------------------------------------------------------------------------------------------------------|-------------------------------------------------------------------------------------------------------------------------------------------------------------------------------------------------------------------------------------------------------------|----------------------------------------------------------------------------------------------------------------------------------------------------------------------------------------------------------------------------------------------------------------------------------------------------------------------------------------------------------------------------------------------------------------------------------------------------------------------------------------------|
| <p style="text-align: center;"><b>20441</b></p>  <p style="text-align: center;"><b>3"</b><br/><b>24 GRIT</b><br/><b>WHITE</b></p> <p style="text-align: center;">10</p> | <p style="text-align: center;"><b>20442</b></p>  <p style="text-align: center;"><b>3"</b><br/><b>36 GRIT</b><br/><b>RED</b></p> <p style="text-align: center;">10</p> | <p style="text-align: center;"><b>20443</b></p>  <p style="text-align: center;"><b>3"</b><br/><b>60 GRIT</b><br/><b>ORANGE</b></p> <p style="text-align: center;">10</p> | <p style="text-align: center;"><b>20444</b></p>  <p style="text-align: center;"><b>3"</b><br/><b>120 GRIT</b><br/><b>GREEN</b></p> <p style="text-align: center;">10</p> <hr/> <p style="text-align: center;"><b>20450</b></p>  <p style="text-align: center;"><b>ARBOR</b></p> <p style="text-align: center;">1</p> |
|----------------------------------------------------------------------------------------------------------------------------------------------------------------------------------------------------------------------------------------------------------|---------------------------------------------------------------------------------------------------------------------------------------------------------------------------------------------------------------------------------------------------------|-------------------------------------------------------------------------------------------------------------------------------------------------------------------------------------------------------------------------------------------------------------|----------------------------------------------------------------------------------------------------------------------------------------------------------------------------------------------------------------------------------------------------------------------------------------------------------------------------------------------------------------------------------------------------------------------------------------------------------------------------------------------|



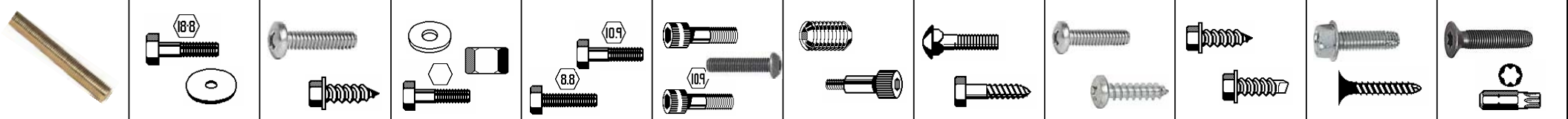







**J&B Fleet - Industrial Supply**

22428 Harrisburg-Westville Rd. Alliance, Ohio 44601 Phone: (330) 821-6342 Fax: (330) 821-0411

[www.jbfleet.com](http://www.jbfleet.com)

PART # 2131

**ROLON SURFACE DISCS**

|                                                                                                                                                                  |                                                                                                                             |                                                                                                                               |                                                                                                                               |
|------------------------------------------------------------------------------------------------------------------------------------------------------------------|-----------------------------------------------------------------------------------------------------------------------------|-------------------------------------------------------------------------------------------------------------------------------|-------------------------------------------------------------------------------------------------------------------------------|
| <p>40444 1</p>  <p>3" MEDIUM</p> <p>10</p>                                      | <p>40446 2</p>  <p>3" COARSE</p> <p>10</p> | <p>40440 3</p>  <p>2" MEDIUM</p> <p>10</p> | <p>40442 4</p>  <p>2" COARSE</p> <p>10</p> |
| <p>Non-woven surface conditioning discs are ideal for deburring, cleaning, blending, and polishing. Use on mild steel, stainless, aluminum, plastic or wood.</p> |                                                                                                                             | <p>40448 5</p>  <p>2" ARBOR</p> <p>1</p> | <p>40449 6</p>  <p>3" ARBOR</p> <p>1</p> |

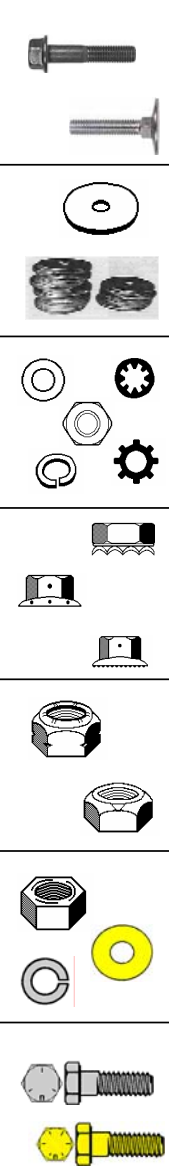











## J&B Fleet - Industrial Supply

www.jbfleet.com

22428 Harrisburg-Westville Rd. Alliance, Ohio 44601 Phone: (330) 821-6342 Fax: (330) 821-0411

PART # 2204

# ROL-ON SANDING DISCS

|                                                                                                                                                      |                                                                                                                                                      |                                                                                                                                                       |
|------------------------------------------------------------------------------------------------------------------------------------------------------|------------------------------------------------------------------------------------------------------------------------------------------------------|-------------------------------------------------------------------------------------------------------------------------------------------------------|
| <p>1</p> <p><b>41952</b></p>  <p>5</p> <p><b>2" 120 GRIT 3M</b></p> | <p>2</p> <p><b>41950</b></p>  <p>5</p> <p><b>2" 36 GRIT 3M</b></p> | <p>3</p> <p><b>38966</b></p>  <p>3</p> <p><b>3" 80 GRIT</b></p>    |
| <p>4</p> <p><b>41981</b></p>  <p>5</p> <p><b>2" 80 GRIT 3M</b></p>  | <p>5</p>                                                                                                                                             | <p>6</p> <p><b>38896</b></p>  <p>3</p> <p><b>3" 50 GRIT</b></p>    |
| <p>7</p> <p><b>41980</b></p>  <p>5</p> <p><b>2" 50 GRIT 3M</b></p>  | <p>8</p> <p><b>41979</b></p>  <p>3</p> <p><b>2" 24 GRIT 3M</b></p> | <p>9</p> <p><b>38897</b></p>  <p>3</p> <p><b>3" 36 GRIT</b></p>    |
| <p>10</p>                                                                                                                                            | <p>11</p>                                                                                                                                            | <p>12</p> <p><b>38898</b></p>  <p>3</p> <p><b>3" 24 GRIT</b></p> |





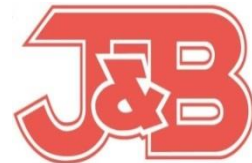







PART#2849

**J&B Fleet - Industrial Supply**

22428 Harrisburg-Westville Rd. Alliance, Ohio 44601 Phone: (330) 821-6342 Fax: (330) 821-0411

[www.jbfleet.com](http://www.jbfleet.com)

**ROLON SURFACE DISCS - SHARK**

|                                                                                                                                                                                                           |                                                                                                                                    |                                                                                                                                                           |                                                                                                                                                          |
|-----------------------------------------------------------------------------------------------------------------------------------------------------------------------------------------------------------|------------------------------------------------------------------------------------------------------------------------------------|-----------------------------------------------------------------------------------------------------------------------------------------------------------|----------------------------------------------------------------------------------------------------------------------------------------------------------|
| <p>41897</p>  <p><b>3" SHARK</b></p> <p>10</p>                                                                          | <p>41898</p>  <p><b>3" SHARK</b></p> <p>10</p> | <p>41893</p>  <p><b>2" SHARK</b></p> <p>2" MEDIUM MAROON</p> <p>10</p> | <p>41895</p>  <p><b>2" SHARK</b></p> <p>2" COARSE BROWN</p> <p>10</p> |
| <p>3" MEDIUM MAROON</p> <p>10</p> <p><b>Non-woven surface conditioning discs are ideal for deburring, cleaning, blending, and polishing. Use on mild steel, stainless, aluminum, plastic or wood.</b></p> |                                                                                                                                    | <p>40448</p>  <p><b>2" ARBOR</b></p> <p>1</p>                        | <p>40449</p>  <p><b>3" ARBOR</b></p> <p>1</p>                       |





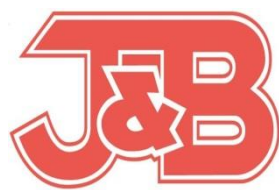
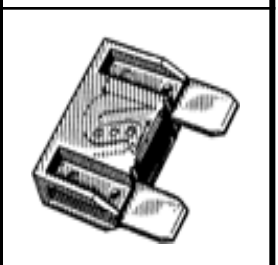

**PART# 2858**

**J&B Fleet - Industrial Supply**

22428 Harrisburg-Westville Rd. Alliance, Ohio 44601 Phone: (330) 821-6342 Fax: (330) 821-0411

[www.jbfleet.com](http://www.jbfleet.com)

**2" ROLON DISCS**

**38899**

**2" FINE BLUE**

10

**40440**

**2" MEDIUM MAROON**

10

**40442**

**2" COARSE BROWN**

10

**40448**

**2" ARBOR**

1





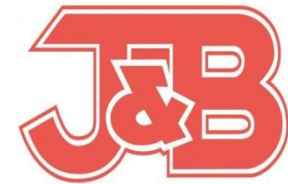
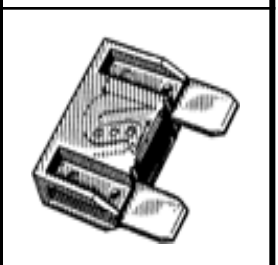

**PART# 2859**

**J&B Fleet - Industrial Supply**

22428 Harrisburg-Westville Rd. Alliance, Ohio 44601 Phone: (330) 821-6342 Fax: (330) 821-0411

[www.jbfleet.com](http://www.jbfleet.com)

**3" ROLON DISCS**

**38900**

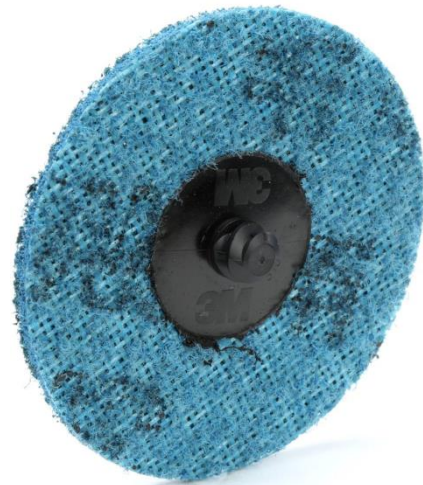

**3"  
FINE  
BLUE**

10

**40444**



**3"  
MEDIUM  
MAROON**

10

**40446**



**3"  
COARSE  
BROWN**

10

**40449**



**3" ARBOR**

1



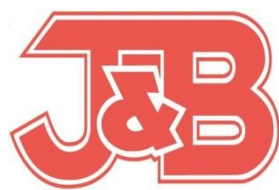
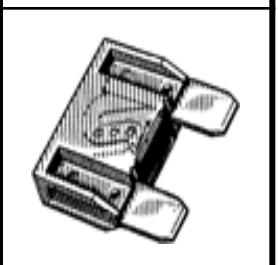
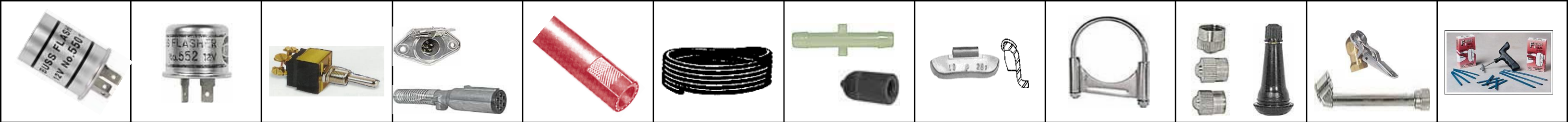

**PART# 2861**

**J&B Fleet - Industrial Supply**

22428 Harrisburg-Westville Rd. Alliance, Ohio 44601 Phone: (330) 821-6342 Fax: (330) 821-0411

[www.jbfleet.com](http://www.jbfleet.com)

**2" ROLON DISCS**

**41988**

**2" FINE BLUE**

10

**41893**

**2" MEDIUM MAROON**

10

**41895**

**2" COARSE BROWN**

10

**40448**

**2" ARBOR**

1





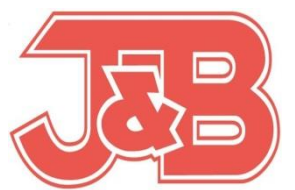

**PART# 2863**

**J&B Fleet - Industrial Supply**

22428 Harrisburg-Westville Rd. Alliance, Ohio 44601 Phone: (330) 821-6342 Fax: (330) 821-0411

[www.jbfleet.com](http://www.jbfleet.com)

**3" ROLON DISCS**

|                                                                                                                                                                                                                                 |                                                                                                                                                                                                                                      |                                                                                                                                                                                                                                      |                                                                                                                                                                                                                               |
|---------------------------------------------------------------------------------------------------------------------------------------------------------------------------------------------------------------------------------|--------------------------------------------------------------------------------------------------------------------------------------------------------------------------------------------------------------------------------------|--------------------------------------------------------------------------------------------------------------------------------------------------------------------------------------------------------------------------------------|-------------------------------------------------------------------------------------------------------------------------------------------------------------------------------------------------------------------------------|
| <p style="text-align: center;"><b>41932</b></p>  <p style="text-align: center;"><b>3" FINE BLUE</b></p> <p style="text-align: center;">10</p> | <p style="text-align: center;"><b>41897</b></p>  <p style="text-align: center;"><b>3" MEDIUM MAROON</b></p> <p style="text-align: center;">10</p> | <p style="text-align: center;"><b>41898</b></p>  <p style="text-align: center;"><b>3" COARSE BROWN</b></p> <p style="text-align: center;">10</p> | <p style="text-align: center;"><b>40449</b></p>  <p style="text-align: center;"><b>3" ARBOR</b></p> <p style="text-align: center;">1</p> |
|---------------------------------------------------------------------------------------------------------------------------------------------------------------------------------------------------------------------------------|--------------------------------------------------------------------------------------------------------------------------------------------------------------------------------------------------------------------------------------|--------------------------------------------------------------------------------------------------------------------------------------------------------------------------------------------------------------------------------------|-------------------------------------------------------------------------------------------------------------------------------------------------------------------------------------------------------------------------------|



LET US HELP YOU MAKE THE CONNECTION

# PART #3115

## DREMEL PRODUCTS



J & B FLEET-INDUSTRIAL SUPPLY  
PHONE: 330-821-6342  
WWW.JBFLEET.COM

**40417**



**40418**



**40419**



**40421**

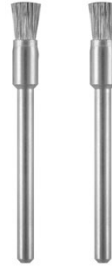

**40423**



**40425**



**40427**



**40428**



**40429**



**40431**









# J&B Fleet - Industrial Supply

22428 Harrisburg-Westville Rd. Alliance, Ohio 44601 Phone: (330) 821-6342 Fax: (330) 821-0411

[www.jbfleet.com](http://www.jbfleet.com)

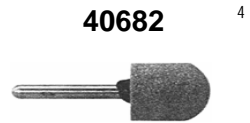
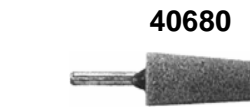
PART # 2139

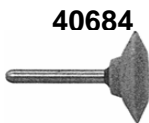
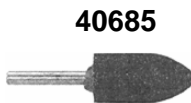
## MOUNTED STONES

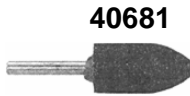
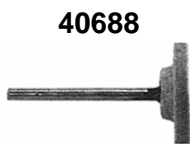
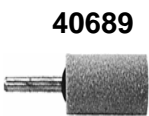
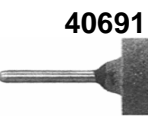
|                                                                                                                           |           |                                                                                                                           |           |                                                                                                                             |           |
|---------------------------------------------------------------------------------------------------------------------------|-----------|---------------------------------------------------------------------------------------------------------------------------|-----------|-----------------------------------------------------------------------------------------------------------------------------|-----------|
|  <p><b>40690</b></p> <p>IND # W235</p>   | <p>2</p>  |  <p><b>40682</b></p> <p>IND #A21</p>    | <p>4</p>  |  <p><b>40680</b></p> <p>IND # A3</p>     | <p>6</p>  |
|  <p><b>40683</b></p> <p>IND # A31</p>    | <p>7</p>  |  <p><b>40684</b></p> <p>IND # A36</p>    | <p>10</p> |  <p><b>40685</b></p> <p>IND # B52</p>    | <p>12</p> |
|  <p><b>40686</b></p> <p>IND # W163</p>   | <p>14</p> |  <p><b>40687</b></p> <p>IND # W185</p> | <p>16</p> |  <p><b>40681</b></p> <p>IND # A11</p>    | <p>18</p> |
|  <p><b>40688</b></p> <p>IND # W215</p> | <p>19</p> |  <p><b>40689</b></p> <p>IND # W220</p> | <p>21</p> |  <p><b>40691</b></p> <p>IND # W236</p> | <p>24</p> |





