

Baldwin Planning Board Meeting Minutes

June 8, 2017

I. Call to order

Norm Blake called to order the regular meeting of the Baldwin Planning Board at 7:05 PM on June 8, 2017 at Baldwin Town Hall.

II. Roll call

Matt Fricker conducted a roll call. The following Planning Board members were present: Norm Blake, Jo Pierce, Matt Fricker, David Strock and Glen Reynolds. Also present were Kathy Pierce, Kurt Olafson, Don and Debra Verrill, Nik Harrington, Selectman Dwight Warren and CEO Wes Sunderland.

III. Approval of minutes from last meeting

Matt Fricker read the minutes from the last meeting. The Minutes were amended and approved by a 4-1 vote of the Board.

IV. Open issues

- a) Community Center – The topic of renters putting signs up for their businesses was discussed. The feasibility of painting signs or a directory on the building was discussed. Only road signs are subject to the 20 square foot dimension restriction. It was suggested that the Town write standards to which renters will be held for signs on the building into the CUP.
- b) D&D Oil –
 - The Planning Board reviewed the list of Proposed Conditions for the CUP from the 5.25.2017 Minutes.
 - The gate should be at least 100 feet off of the road (Route 113).
 - Post DEP spill-reporting phone number by gate so it is visible in case of spills.
 - Ensure field is stumped out adequately and drivable so trucks have room to move around and especially so emergency crews have room to operate in the event of a spill or fire.

- N.B. Reference St.Germain-Collins Figure 4 (page 8) in CUP (initialed by applicant) East Gate post to SE corner – clear out that triangle.
- Plant and maintain a double-staggered row of ≥ 6 foot white pines as a visual barrier between the facility and the road.
- Tanks painted in a matte finish – consider light grey vs. primer red.
- The topic of locks for the main (king) valves was discussed. It was determined by the Planning Board that this was not intended to be a condition for the CUP.
- Provide copy of SPCC to Baldwin Fire Chief
- Hours of operation are 24x7
- Lighting must be low intensity from dusk to dawn to prevent light pollution and all lighting should directed be inward and downward, including all lighting on rack.
- It is proposed that there be no limit to truck traffic.
- Any signage must be less than 20 square feet. 10 square feet recommended.
- No painting of company names or logos on tanks that would be noticeable from the road.
- Obey all State and Federal laws
- Provide a copy of State Fire Marshall permit to Town.
- D&D Oil shall provide an annual statement via mail on the date of the CUP approval attesting that the containment unit is in good working order.
- All of the applicants submissions are included in the CUP and the statements contained therein are material to the CUP unless modified in writing by the Planning Board.
- The Town Fire Department must be notified within 24 hours of any spill.
- D&D Oil shall provide proof of liability insurance, specifically for the Bulk Oil Storage facility to the Town.

- D&D Oil should take reasonable efforts to minimize back-up alarms.
 - Standard Conditions (attached)
 - Matt Fricker brought up that Don and Betsy Harrington, who own land at 609 Pequawket Trail in Baldwin sent a letter (attached) via e-mail to Planning Board Vice Chair Jo Pierce on 6.2.17. The Harrington property abuts the proposed fuel storage facility, and the letter addressed their concerns about the D&D Oil Fuel Depot. The Planning Board noted that in the past when written comment was received after the close of public comment (5.25.17 for the D&D Oil Fuel Depot) it has not been considered.
 - The Planning Board voted on the D&D Oil Fuel Depot CUP. It was approved by a vote of 3 to 2.
- d) FEMA Flood Plain Management – New maps that are more accurate are available, and the public needs to be informed about the new maps, perhaps via an ad in the Shopper’s Guide. The old flood plain vs. the new flood plain may impact flood insurance rates and real estate transactions. At the next meeting the Planning Board should make a decision on what to do on FEMA Flood Plain issues vs. spending time re-writing the Shoreland Zoning ordinance.
- e) Nature’s Wilderness: The CEO advised the Planning Board that a permit has been written out for the foundation at Nature’s Wilderness. David Strock said that the permit should not be discussed at the Planning Board but is a topic for discussion at a Selectmen’s Meeting.

V. New business

- a) Cliff Sanborn – The Board discussed a 60 foot right-of-way and frontage on Mr. Sanborn’s property. It was noted he has owned the acreage for more than 5 years. Mr. Sanborn can subdivide the land, get a deed and then a building permit.

VI. Adjournment

Norm Blake adjourned the meeting at 9:20 PM.

Minutes submitted by: Matt Fricker



Town of Baldwin

53- Pequignot Trail
West Baldwin, Maine 04991
Phone: (207) 625-3581
Fax: (207) 625-7700

Date Application Received: _____
Received by: _____
Fee Paid: _____

APPLICATION FOR CONDITIONAL USE PERMIT (CUP)

The Land Use Ordinance of the Town of Baldwin allows the Planning Board to grant a Conditional Use Permit (CUP) for those uses listed specifically as Conditional Uses in Article 6, District Regulations of the code. Before granting a permit, the Board must find that the standards contained in Article 8, Conditional Uses have been met. It is your obligation to submit the necessary materials to allow the Planning Board to determine if those standards have been met. Three copies of the complete application and supporting materials and the applicable fee shall be submitted to the Code Enforcement Officer.

Section A. Basic Information (to be completed by all applicants)

1. Applicant's Legal Name: D&D OIL

2. Applicant's Mailing Address: 14 Mountain View Avenue, Brownfield, ME 04010

3. Phone number where applicant can be reached during business hours. 207-935-3834

4. Are you the owner of record of the property for which the Conditional Use Permit is sought? yes (provide copy of Title and go to question 8)
 no (answer question 5, 6, and 7)

5. To apply for a Cond. Use Permit, you must have legal right, title or interest in the property. Please indicate you interest in the property and attach written evidence of this interest.

6. Property Owner's Name Dale Verrill

7. Property Owner's Address 14 Mountain View Ave
Braunfield
04010

8. Location of property for Which the permit is sought? 534 Pequawket Trail, West Baldwin, ME 04091

9. Indicate the Map and Lot number for the Property from the Town's assessment records Map 5 Lot 16

10. Indicate Zoning District in which the Property is located (check as many as apply)

- Natural Resource Protection
- Highlands
- Rural
- Village Commercial

11. List the use for which a Conditional Use Permit is being sought. Please refer to Article 6, District Regulations. The proposed use must be specifically listed as conditional use in the District in which it is located.

Warehousing, Storage, and Distribution

12. Attach the following information to this application as outlined in Article 8, Conditional Uses. For each item, please indicate by checking that item that it has been included with your application.

- a. A location map showing the location of the property with respect to Roadways and major natural features. This map should allow the Board to locate the parcel in the field and on the Town's zoning and tax maps.

- b. A written description of the proposed use of the property. This statement shall describe the exact nature of the proposed use.
- c. An accurate, scale drawing of the lot showing the location of any existing or proposed buildings, structures, and natural features, driveways and parking areas.

Section B. Standards for Conditional Use Permit
(The full text appears in Article 8.3).

1. The Planning Board shall consider impact:

- a. the size of the proposed use compared with surrounding uses;
- b. the intensity of the proposed use, including amount and type of traffic to be generated, hours of operation, expanse of pavement, and similar measures of intensity of use, compared with surrounding uses;
- c. the potential generation of noise, dust, odor, vibration, glare, smoke, litter and other nuisances;
- d. unusual physical characteristics of the site, including size of the lot, shape of the lot, topography, and soils, which may tend to aggravate adverse impacts upon surrounding properties.
- e. the degree to which landscaping, fencing, and other design elements have been incorporated to mitigate adverse impacts on surrounding properties.

2. The Planning Board shall consider facilities:

- a. the ability of traffic to safely move into and out of the site at the proposed location;
- b. the presence of facilities to assure the safety of pedestrians passing by or through the site;
- c. the capacity of the street network to accommodate the proposed use;
- d. the capacity of the storm drainage system to accommodate the proposed use;
- e. the ability of the Town to provide necessary fire protection services to the site and development.

3. The Planning Board shall consider natural characteristics:

The natural characteristics of the site, including topography, drainage, and relationship to ground and surface waters and flood plains, shall not be such that the proposed use when placed on the site will cause undue harm to the environment or to neighboring properties.

Section C. Shoreland Standards

Section to be completed only if any portion of the property is located within 250 feet of the normal high water mark of Ingalls Pond, Sand Pond, Southeast Pond, Adams Pond or the Saco River or within 75 feet of any stream. For each standard, attach a written statement demonstrating how the proposed use complies with that standard. For each item, please indicate by checking that item that it has been included with your application. Each standard must be addressed in your submission.

- a. will not result in unreasonable damage to spawning grounds. Fish aquatic life, bird and other wildlife habitat;
- b. will reasonably conserve shoreland vegetation;
- c. will reasonably conserve visual points of access to waters as viewed from public facilities;
- d. will conserve actual points of public access to waters;
- e. will reasonably conserve natural beauty;
- f. will reasonably avoid problems associated with floodplain development or use.

Section D. Certification (to be completed by all applicants)

I/we Dale Yerrill - Dora Vezell certify that I/we are the legal applicants for the Conditional Use Permit requested by this application, that I/we are the owners of the property covered by this application or have the property owner's consent to the filing of this application and have legal interest in the property and that the information contained in this application and supporting material is accurate and true.

I/we further certify that I/we have read the standards for granting of Conditional Use Permits contained in the Land Use Ordinance.

Dale Yerrill 4-20-17
Signature of Applicant Date

Dora Vezell 4-20-17
Signature of Applicant Date

For Planning Board Use Only

Date Received by Baldwin Planning Board:

5/11/17

Received by:

Josiah Pierce

Public Hearing Date:

5/25/17

Conditional Use Permit Application of:

D&D Oil

Permit Denied (date):

Explanation of Denial:

Permit Approved (date):

6/8/17

Conditions to Permit if any,

attached

APPLICANT SIGNATURE ACCEPTANCE

Dak Yurwitz

Josiah Pierce

U S M BLAKE

Deborah E. Moore

James G.

6

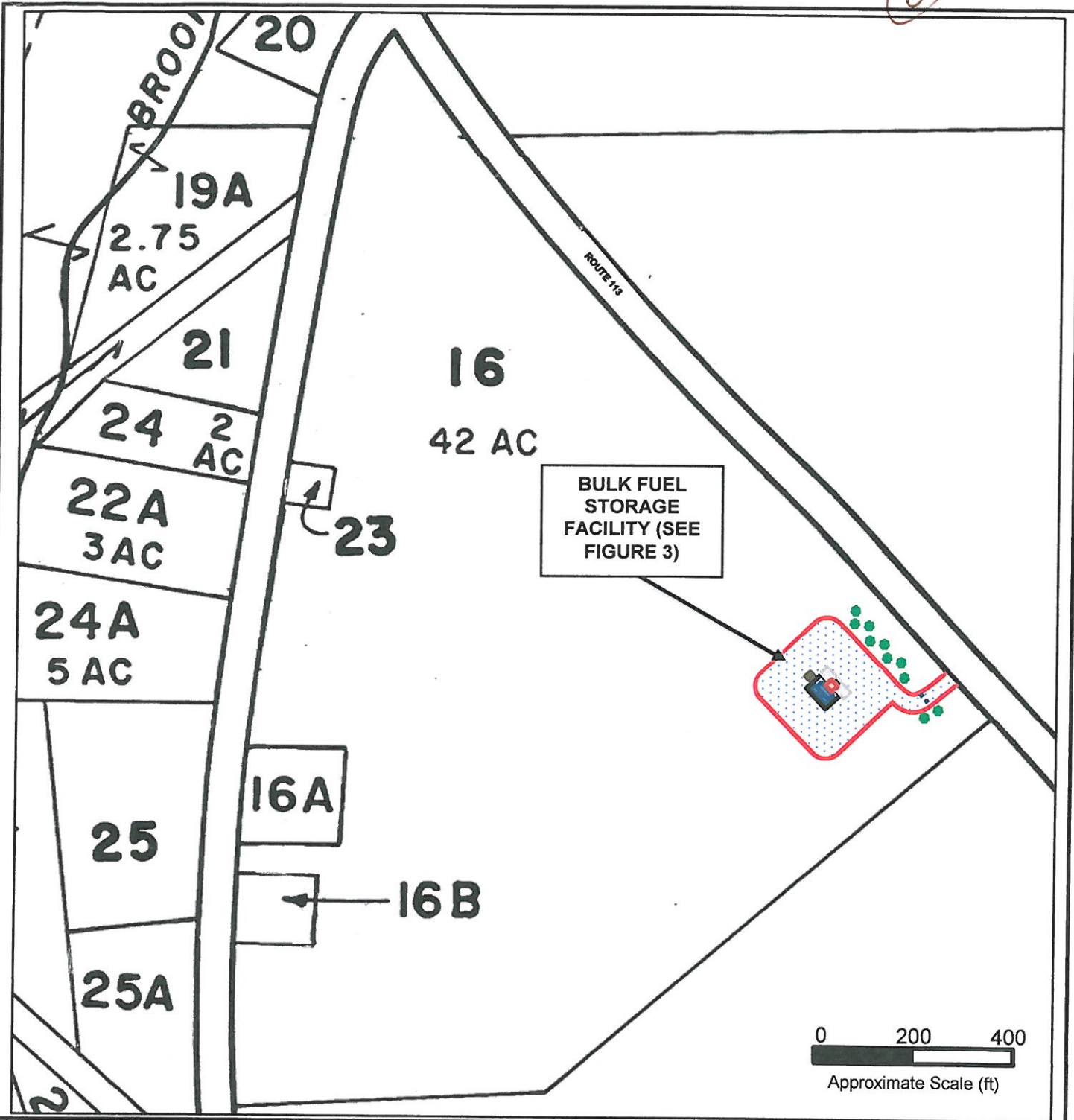

BULK FUEL
STORAGE
FACILITY (SEE
FIGURE 3)



REFERENCE: TOWN OF BALDWIN, MAINE - TAX MAP 5, LOT 16

 FACILITY BOUNDARY (APPROX.)



LOT PLAN

D&D OIL
534 PEQUAWKET TRAIL
WEST BALDWIN, ME

D&D OIL
14 MOUNTAIN VIEW AVENUE
BROWNFIELD, ME 04010

St. Germain • Collins

FIGURE
2

17

16

42 AC

23

ROUTE 113

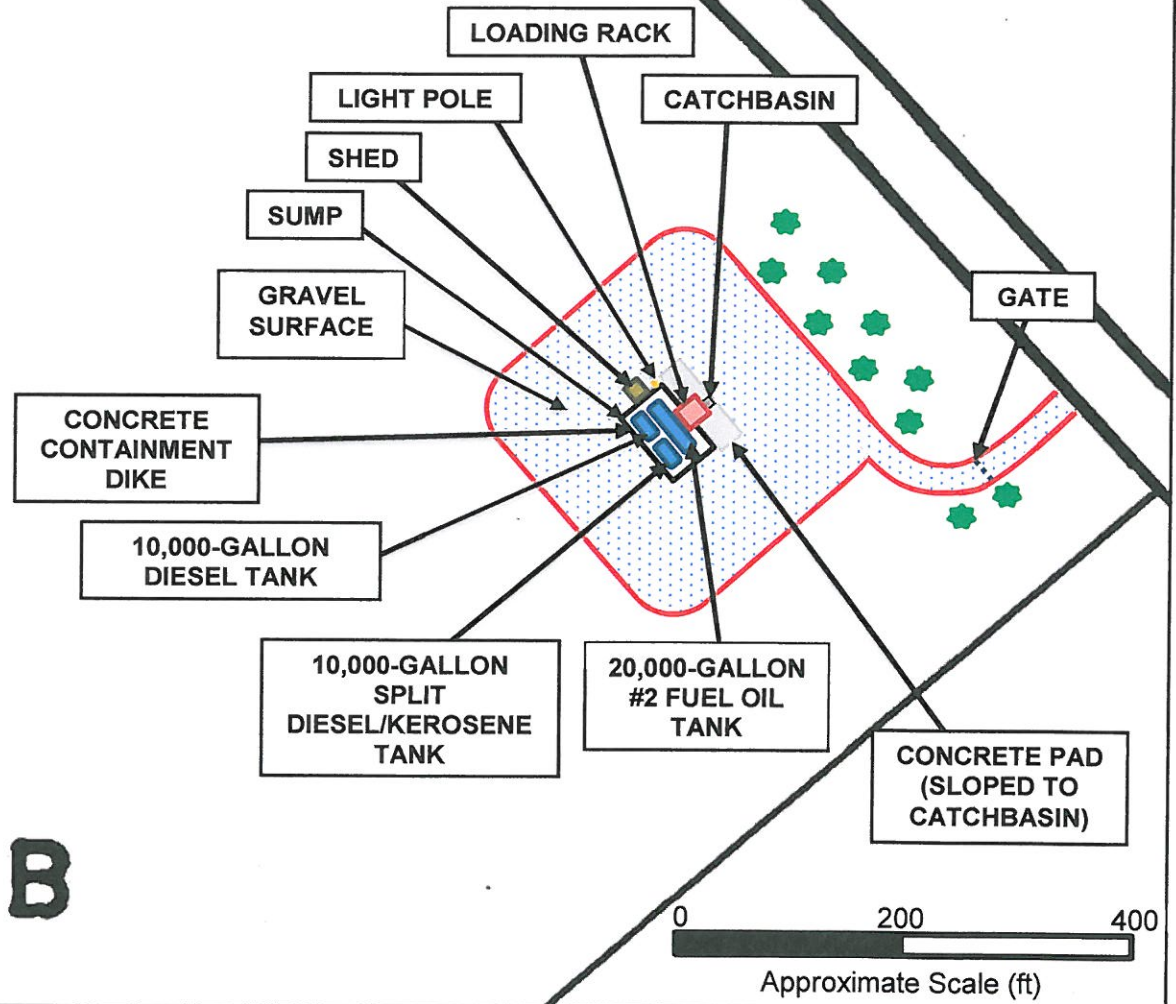

16B

0 200 400
Approximate Scale (ft)

REFERENCE: TOWN OF BALDWIN, MAINE - TAX MAP 5, LOT 16

 FACILITY BOUNDARY (APPROX.)

 6' HIGH WHITE PINES (10)

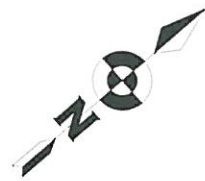

OVERALL SITE PLAN

D&D OIL
534 PEQUAWKET TRAIL
WEST BALDWIN, ME

D&D OIL
14 MOUNTAIN VIEW AVENUE
BROWNFIELD, ME 04010

St. Germain • Collins

FIGURE
3

9

St.Germain ■ Collins

May 9, 2017

Wes Sunderland
Code Enforcement Officer
Town of Baldwin
534 Pequawket Trail
West Baldwin, Maine 04091

Re: Supplemental Submission
Proposed Bulk Oil Storage Facility
D&D Oil
Route 113, West Baldwin, Maine
St.Germain Collins File No.: 4076

Dear Mr. Sunderland:

St.Germain Collins, on behalf of D&D Oil, is submitting this Supplemental Submission to their Application for Conditional Use Permit for a proposed bulk oil storage facility on a portion of a 42-acre parcel on Route 113 in West Baldwin, Maine.

At the April 27, 2017 Planning Board (PB) meeting, the PB requested the following:

1. Can a Site Plan be provided with more detail? *Figure 4 is enclosed.*
2. Can shed location be shown on Site Plan? *Shed shown on Figure 4.*
3. Will trucks be parked at the facility? *Yes, there is a possibility that up to two delivery trucks will be parked at the facility during nighttime hours.*
- 4. What are the hours of operation? *The facility will be used from 6:00 AM to 8:00 PM Monday through Saturday.*
- 5. What is the typical truck traffic? *Up to 15 delivery truck loads and 4 tankers will be in and out of the facility weekly during the months of November through April. Truck traffic will be less during the other months.*
6. There was discussion whether additional landscaping is needed? *Trees do remain along the edge of Route 113. It is proposed that the need for additional landscaping be discussed at the Site Walk, scheduled for May 20th. If additional landscaping is deemed necessary by PB, it will be added to the Site Plan prior to PB meeting on May 25th.*
7. Can a low-intensity light be installed? *One pole light will be installed, see Figure 4 and enclosed cut sheet for proposed pole-mounted light (or similar equivalent).*
8. Can we provide a copy of DOT Driveway Permit? *Permit is enclosed.*

EXPERIENCE YOU CAN RELY ON
WHEN IT COUNTS

It should be noted that the original application was for two (2) 20,000-gallon horizontal steel storage tanks for No. 2 fuel oil, diesel, and kerosene. After further research, D&D Oil instead proposes three tanks: One (1) 20,000-gallon No. 2 Fuel Oil, one (1) 10,000-gallon Diesel, and one (1) 10,000-gallon split Diesel/Kerosene. The total oil storage will remain at 40,000 gallons.

We look forward to presenting the application to the PB at their May 25, 2017 meeting. Please do not hesitate to contact us should you have any questions or require additional information.

Sincerely,
STGERMAIN COLLINS

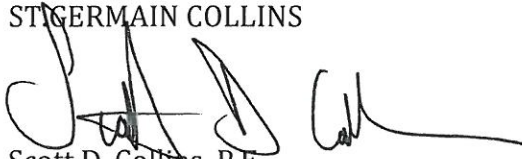
Scott D. Collins, P.E.
Managing Principal

enclosures

cc: Dale Verrill – D&D Oil

12



KAX LED Size 1 LED Area Luminaire



Catalog Number
Notes
Type

Specifications

EPA:	0.7 ft ² <small>(0.07 m²)</small>
Length:	25" <small>(0.64 m)</small>
Width:	13-1/4" <small>(0.34 m)</small>
Height:	7-3/4" <small>(0.19 m)</small>
Weight (max):	26 lbs <small>(11.8 kg)</small>

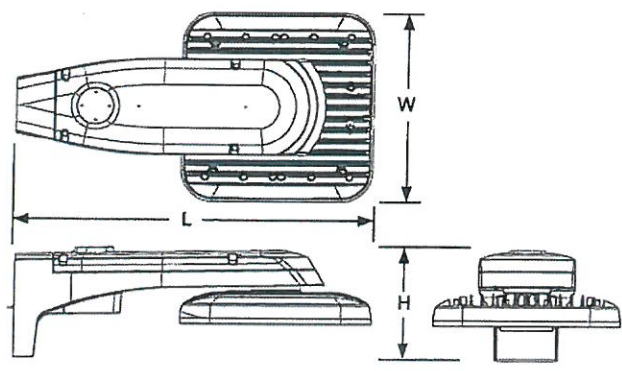

A+ Capable Luminaire

This item is an A+ capable luminaire, which has been designed and tested to provide consistent color appearance and system-level interoperability.

- All configurations of this luminaire meet the Acuity Brands' specification for chromatic consistency
- This luminaire is A+ Certified when ordered with DTL[®] controls marked by a shaded background. DTL DLL equipped luminaires meet the A+ specification for luminaire to photocontrol interoperability¹
- This luminaire is part of an A+ Certified solution for ROAM[®]2 or XPoint[™] Wireless control networks, providing out-of-the-box control compatibility with simple commissioning, when ordered with drivers and control options marked by a shaded background¹

To learn more about A+, visit www.acuitybrands.com/a-plus

1. See ordering tree for details.
2. A+ Certified Solutions for ROAM require the order of one ROAM node per luminaire. Sold Separately: [Link to Roam](#); [Link to DTL DLL](#)

A+ Capable options indicated by this color background.

Ordering Information

EXAMPLE: KAX1 LED P4 40K R3 MVOLT SPA DDBXD

KAX1 LED

Series	Performance package	Color temperature	Distribution	Voltage	Mounting
KAX1 LED	P1	30K 3000 K	R3 Type 3	MVOLT ¹	Shipped included
	P2	40K 4000 K	R4 Type 4	120 ¹	SPA Square pole mounting
	P3	50K 5000 K	R5 Type 5	208 ¹	RPA Round pole mounting
	P4			240 ¹ 277 ¹ 347 480	Shipped separately KMA Mast arm adapter ^{2,3}

Control options	Other options	Finish (options)
Shipped installed	Shipped installed	DDBXD Dark bronze
PER NEMA twist-lock receptacle only (no controls) ^{4,5}	HS House-side shield ⁹	DBLXD Black
PERS Five-wire receptacle only (no controls) ^{5,6}	SF Single fuse (120, 277, 347V) ¹⁰	DNAXD Natural aluminum
PER7 Seven-wire receptacle only (no controls) ^{5,6}	DF Double fuse (208, 240, 480V) ¹¹	DWHXD White
PIR Bi-level, motion/ambient sensor, 8-15' mounting height, ambient sensor enabled at 5fc ⁷	TILT Tilt arm	DDBTXD Textured dark bronze
PIRH Bi-level, motion/ambient sensor, 15-30' mounting height, ambient sensor enabled at 5fc ⁷	Shipped separately	DBL BXD Textured black
PIR1FC3V Bi-level, motion/ambient sensor, 8-15' mounting height, ambient sensor enabled at 1fc ⁷	BS Bird spikes ⁹	DNATXD Textured natural aluminum
PIRH1FC3V Bi-level, motion/ambient sensor, 15-30' mounting height, ambient sensor enabled at 1fc ⁷	EGS External glare shield ⁹	DWHGXD Textured white
FAO Field adjustable output ⁸		



One Lithonia Way • Conyers, Georgia 30012 • Phone 800.279.8041 •
© 2011-2017 Acuity Brands Lighting, Inc. All rights reserved.

KAX1-LED
Rev. 02/08/17
Page 1 of 3

Ordering Information

Accessories	
DL127F 1.5 JU	PhotoCell - SSL twist-lock (120-277V) ¹⁾
DL147F 1.5 CUL JU	PhotoCell - SSL twist-lock (347V) ¹⁾
DL480F 1.5 CUL JU	PhotoCell - SSL twist-lock (480V) ¹⁾
DSHORT SBK II	Shorting cap ¹⁾
KMADD8XD U	Mount arm mounting bracket adaptor (specify finish) ¹⁾
KAX1HS P1/P2 U	House-side shield (P1, P2)
KAX1HS P3/P4 U	House-side shield (P3, P4)
KXBS U	Bird spikes
KAXTEGS U	External glare shield

For more control options, visit [www.lithonia.com](#) and [www.lithonia.com](#) online

- 1) PhotoCell is not available in some areas. Please refer to the PhotoCell website for more information.
- 2) PhotoCell is not available in some areas. Please refer to the PhotoCell website for more information.
- 3) PhotoCell is not available in some areas. Please refer to the PhotoCell website for more information.
- 4) PhotoCell is not available in some areas. Please refer to the PhotoCell website for more information.
- 5) PhotoCell is not available in some areas. Please refer to the PhotoCell website for more information.
- 6) PhotoCell is not available in some areas. Please refer to the PhotoCell website for more information.
- 7) PhotoCell is not available in some areas. Please refer to the PhotoCell website for more information.
- 8) PhotoCell is not available in some areas. Please refer to the PhotoCell website for more information.
- 9) PhotoCell is not available in some areas. Please refer to the PhotoCell website for more information.
- 10) PhotoCell is not available in some areas. Please refer to the PhotoCell website for more information.
- 11) PhotoCell is not available in some areas. Please refer to the PhotoCell website for more information.
- 12) PhotoCell is not available in some areas. Please refer to the PhotoCell website for more information.
- 13) PhotoCell is not available in some areas. Please refer to the PhotoCell website for more information.
- 14) PhotoCell is not available in some areas. Please refer to the PhotoCell website for more information.
- 15) PhotoCell is not available in some areas. Please refer to the PhotoCell website for more information.
- 16) PhotoCell is not available in some areas. Please refer to the PhotoCell website for more information.
- 17) PhotoCell is not available in some areas. Please refer to the PhotoCell website for more information.
- 18) PhotoCell is not available in some areas. Please refer to the PhotoCell website for more information.
- 19) PhotoCell is not available in some areas. Please refer to the PhotoCell website for more information.
- 20) PhotoCell is not available in some areas. Please refer to the PhotoCell website for more information.

Drilling

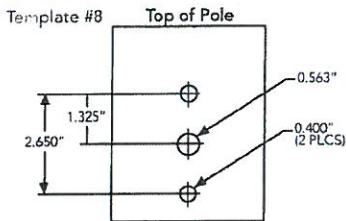

KAX1 shares a unique drilling pattern with the AERIS™ family. Specify this drilling pattern when specifying poles, per the table below.

DM19AS	Single unit	DM29AS	2 at 90° *
DM28AS	2 at 180°	DM39AS	3 at 90° **
DM49AS	4 at 90° **	DM32AS	3 at 120° ***

Example: SSA 20 4C DM19AS ODBXD
 Visit Lithonia Lighting's [www.lithonia.com](#) to see our wide selection of poles, accessories and educational tools.
 *Round pole top must be 3.25" O.D. minimum.
 **For round pole mounting (RPA) only.

Tenon Mounting Slipfitter**

Tenon O.D.	Slipfitter	2 at 180°	2 at 90°	3 at 120°	3 at 90°	4 at 90°
2-3/8"	AST20-190	AST20-280	AST20-290	AST20-320	AST20-390	AST20-490
2-7/8"	AST25-190	AST25-280	AST25-290	AST25-320	AST25-390	AST25-490
4"	AST35-190	AST35-280	AST35-290	AST35-320	AST35-390	AST35-490

Photometric Diagrams

To see complete photometric reports or download .ies files for this product, visit Lithonia Lighting's KAX1 Area Light homepage Isofootcandle plots for the KAX1 LED P4 40K. Distances are in units of mounting height (30').

LEGEND

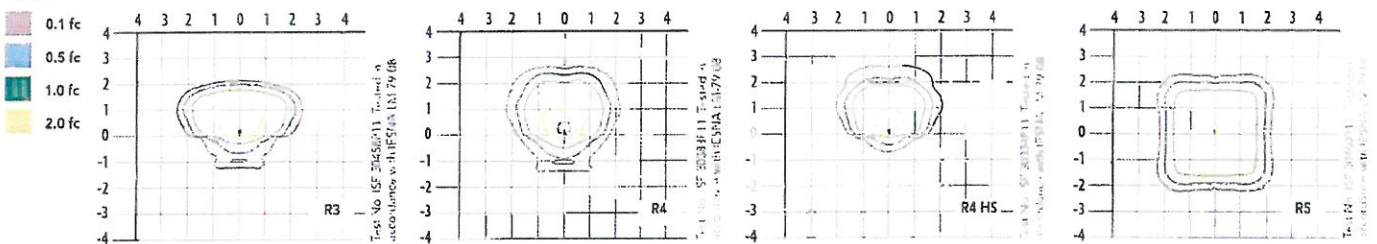

13

Performance Data

Lumen Output

Lumen values are from photometric tests performed in accordance with IESNA LM-79-08. Data is considered to be representative of the configurations shown, within the tolerances allowed by Lighting Facts. Contact factory for performance data on any configurations not shown here.

Performance Package	System Watts	Dist. Type	30K (3000K, 70 CRI)					40K (4000K, 70 CRI)					50K (5000K, 70 CRI)				
			Lumens	B	U	G	LPW	Lumens	B	U	G	LPW	Lumens	B	U	G	LPW
P1	50	R3	6,212	1	0	1	124	6,628	1	0	1	133	6,745	1	0	2	135
		R4	6,444	1	0	1	129	6,876	1	0	1	138	6,997	1	0	1	140
		R5	6,826	3	0	1	137	7,283	3	0	1	146	7,411	3	0	1	148
P2	96	R3	10,687	2	0	2	111	11,403	2	0	2	119	11,603	2	0	2	121
		R4	11,087	2	0	2	115	11,829	2	0	2	123	12,037	2	0	2	125
		R5	11,743	3	0	1	122	12,529	3	0	2	131	12,750	3	0	2	133
P3	130	R3	15,567	2	0	3	120	16,609	2	0	3	128	16,902	2	0	3	130
		R4	16,149	2	0	3	124	17,230	2	0	3	133	17,533	2	0	3	135
		R5	17,106	4	0	2	132	18,251	4	0	2	140	18,572	4	0	2	143
P4	160	R3	18,623	3	0	3	116	19,869	3	0	3	124	20,219	3	0	3	126
		R4	19,319	3	0	3	121	20,612	3	0	3	129	20,975	3	0	3	131
		R5	20,463	4	0	2	128	21,833	4	0	2	136	22,217	4	0	2	139

Lumen Ambient Temperature (LAT) Multipliers

Use these factors to determine relative lumen output for average ambient temperatures from 0-50°C (32-122°F)

* Shaded cells include active dynamic temperature sensing.

Ambient	Lumen Multiplier			
	P1	P2	P3	P4
0°C	1.05	1.05	1.05	1.05
10°C	1.03	1.03	1.03	1.03
20°C	1.01	1.01	1.01	1.01
25°C	1	1	1	1
30°C	0.99	0.99	0.99	0.99
40°C	0.97	0.97	0.97	0.95
45°C	0.96	0.96	0.93	0.81
50°C	0.95	0.95	0.78	0.67

Electrical Load

Package		120V	208V	240V	277V	347V	480V
P1	Current (A)	0.42A	0.24A	0.21A	0.18A	0.15A	0.12A
	System Watts	50W	49W	49W	49W	49W	49W
P2	Current (A)	0.80A	0.46A	0.40A	0.35A	0.28A	0.21A
	System Watts	96W	94W	94W	93W	94W	93W
P3	Current (A)	1.08A	0.62A	0.54A	0.47A	0.39A	0.30A
	System Watts	130W	127W	127W	126W	128W	128W
P4	Current (A)	1.33A	0.76A	0.66A	0.58A	0.48A	0.36A
	System Watts	160W	156W	156W	155W	159W	159W

Projected LED Lumen Maintenance

Operating Hours	25,000	50,000	100,000
Lumen Maintenance Factor	>0.94	>0.89	>0.80

Values calculated according to IESNA TM-21-11 methodology and valid up to 40°C.

FEATURES & SPECIFICATIONS

INTENDED USE

This feature-rich luminaire embodies the highest level of functionality with extraordinary efficacy which maximizes your application efficiency providing high levels of light for minimal cost specifically on small to medium sized parking lots like banks, restaurants, service stations, corporate offices and strip malls.

CONSTRUCTION

Separated die-cast aluminum heat sink and mounting arm allow maximum air flow and separated electrical compartments to promote cool operating environments extending component life. This modular design allows for ease of maintenance and future light engine upgrades. The KAX features a field rotatable optical assembly enabling on-the-fly adjustments when plans change, and can even be tilted upwards if necessary for additional forward throw. The housing is completely sealed against moisture and environmental contaminants (IP66). Low EPA (0.7 ft²) for optimized pole wind loading.

FINISH

Exterior parts are protected by a zinc-infused Super Durable TGIC thermoset powder coat finish that provides superior resistance to corrosion and weathering. A tightly controlled multi-stage process ensures a minimum 3 mils thickness for a finish that can withstand extreme climate changes without cracking or peeling. Available in both textured and non-textured finishes.

OPTICS

Individually formed acrylic lenses are engineered for superior application efficiency which maximizes the light in the areas where it is most needed. Light engines are available in 3000 K, 4000 K or 5000 K (minimum 70 CRI) configurations. In its standard configuration the KAX has zero uplight and qualifies as a Nighttime Friendly™ product, meaning it is consistent with the LEED® and Green Globes™ criteria for eliminating wasteful uplight. With the TILT option, the optical assembly can be raised up to 80 degrees for additional forward throw or to provide vertical illumination.

ELECTRICAL

Light engine(s) configurations consist of high-efficacy LEDs mounted to metal-core circuit boards to maximize heat dissipation and promote long life (>L80/100,000 hours). Class 1 electronic drivers are designed to have a power factor >90%, THD <20%, and an expected life of 100,000 hours. Easily serviceable 10kV surge protection device meets a minimum Category C Low operation (per ANSI/IEEE C62.41.2)

INSTALLATION

The base of the mounting arm features a universal mounting template to facilitate quick and easy installation. Mounting bolts featuring a 1000-hour salt fog finish are utilized to secure the luminaire providing up to a 1.5 G vibration load rating per ANSI C136.31. The KAX utilizes the AERIS™ series pole drilling pattern. Optional bi-level motion sensor and NEMA 3, 5 or 7 pin twist lock photocontrol receptacle are also available.

LISTINGS

CSA Listed for wet locations. Light engines and electrical compartment are IP66 rated. Rated for temperatures as low as -40°C minimum ambient.

DesignLights Consortium® (DLC) qualified product. Not all versions of this product may be DLC qualified. Please check the DLC Qualified Products List at [www.dlc.com](#) to confirm which versions are qualified.

WARRANTY

5-year limited warranty. Complete warranty terms located at: [www.lithonia.com](#)

Note: Actual performance may differ as a result of end-user environment and application. All values are design or typical values, measured under laboratory conditions at 25 °C. Specifications subject to change without notice.





Maine Department of Transportation

Paul R. LePage
Governor

Driveway/Entrance Permit

David Bernhardt, P.E.
Commissioner

Permit Number: 18366 - Entrance ID: 1

OWNER

Name: Dale Verrill
 Address: 14 Mountain View Avenue
 Brownfield, ME 04010
 Telephone: (207)935-3834

LOCATION

Route: 0113X, Pequawket Trail
 Municipality: Baldwin
 County: Cumberland
 Tax Map: 5 Lot Number: 16
 Culvert Size: 15 inches
 Culvert Type: metal/plastic
 Culvert Length: 34 feet
 Date of Permit: May 02, 2016
 Approved Entrance Width: 24 feet

Date Printed: May 03, 2016

In accordance with rules promulgated under 23 M.R.S.A., Chapter 13, Subchapter I, Section 704, the Maine Department of Transportation (MaineDOT) approves a permit and grants permission to perform the necessary grading to construct, in accordance with sketch or attached plan, an Entrance to Commercial Industrial at a point 1810 feet East from Pigeon Brook Road / west end at GPS coordinates: 43.807240N, -70.731400W, subject to the Chapter 299 Highway Driveway and Entrance Rules, standard conditions and special conditions (if any) listed below.

Conditions of Approval:

This Permittee acknowledges and agrees to comply with the Standard Conditions and Approval attached hereto and to any Specific Conditions of Approval shown here.

(G = GPS Location; W = Waiver; S = Special Condition)

G - THE ENTRANCE SHOULD BE LOCATED AT GPS COORDINATES: 43.807240N, -70.731400W.

S - In the town of Baldwin on the southerly side of Route 113 / Pequawket Trail, approximately 1810 feet easterly of the west end of Pigeon Brook Road and approximately 35 feet easterly of utility pole 237.

S - The culvert shall be aluminum coated corrugated metal pipe (Type 2) or HDPE smoothbore plastic pipe. Ditching may be required and shall be of sufficient depth and length so that water flows smoothly into and out of the pipe and no standing water results. The Property Owner must call MaineDOT at (207)642-2787 prior to entrance and culvert installation to arrange for an inspection.

S - The entrance shall be paved, at a minimum, from the edge of the existing highway pavement to the edge of the highway right-of-way.

Approved by: Anthony Fontaine Date: 5-03-2016

STANDARD CONDITIONS AND APPROVAL

1. Provide, erect and maintain all necessary barricades, lights, warning signs and other devices as directed by MaineDOT to properly safeguard traffic while the construction is in progress.
2. At no time cause the highway to be closed to traffic
3. Where the driveway is located within a curb, curb and gutter, and/or sidewalk section, completely remove the existing curb, curb and gutter, and/or sidewalk as may be required to create the driveway and restore drainage. All driveways abutting sidewalk sections shall meet the requirements set forth in the Americans with Disabilities Act of 1990, 42 U.S.C. Sec. 12131 et seq.
4. Obtain, have delivered to the site, and install any culverts and/or drainage structures which may be necessary for drainage, the size, type and length as called for in the permit pursuant to 23 M.R.S.A. Sec. 705. All culverts and/or drainage structures shall be new.
5. Start construction of the proposed driveway within twenty-four (24) months of the date of permit issuance and substantially complete construction of the proposed driveway within twelve months of commencement of construction.
6. Comply with all applicable federal, state and municipal regulations and ordinances.
7. Do not alter, without the express written consent of the MaineDOT, any culverts or drainage swales within the MaineDOT right of way.
8. File a copy of the approved driveway permit with the affected municipality or LURC, as appropriate within 5 business days of receiving the MaineDOT approval.
9. Construct and maintain the driveway side slopes to be no steeper than the adjacent roadway side slopes, but in no case to be steeper than 3 horizontal to 1 vertical, unless the side slope is behind existing roadway guardrail, in which case it shall be no steeper than 2 horizontal to 1 vertical.
10. Notify the MaineDOT of a proposed change of use served by the driveway when increase in traffic flow is expected to occur. This does not exempt the need for obtaining a Traffic Movement Permit (TMP) if trip generation meets or exceeds 100 passenger car equivalents (PCE) during the peak hour of the day.
11. Construct or implement and maintain erosion and sedimentation measures sufficient to protect MaineDOT facilities.
12. Driveways shall be designed such that all maneuvering and parking of any vehicles will take place outside the highway right-of-way and where vehicles will exit the premises without backing onto the highway traveled way or shoulders. All driveways will have a turnaround area to accommodate vehicles using the premises.

FURTHER CONDITION OF THE PERMIT

The owner shall assume, the defense of, and pay all damages, fines, and penalties for which he/she shall become liable, and shall indemnify and safe harmless said Department, its representatives, agents and employees from liability, actions against all suits, claims, damages for wrongful death, personal injuries or property damage suffered by any person or association which results from the willful or negligent action or inaction of the owner/applicant (agent) and in proceedings of every kind arising out of the construction and maintenance of said entrance(s), including snow removal.

Nothing herein shall, nor is intended to, waive any defense, immunity or limitation of liability which may be available to the MaineDOT, their officers, agents or employees under the Maine Tort Claims Act or any other privileges and/or immunities provided by law. It is a further condition that the owner will agree to keep the right of way inviolate for public highway purposes and no signs (other than traffic signs and signals), posters, billboards, roadside stands, culvert end walls or private installations shall be permitted within Right of Way limits.

16



State of Maine Department of Transportation Entrance / Driveway Details

PLAN

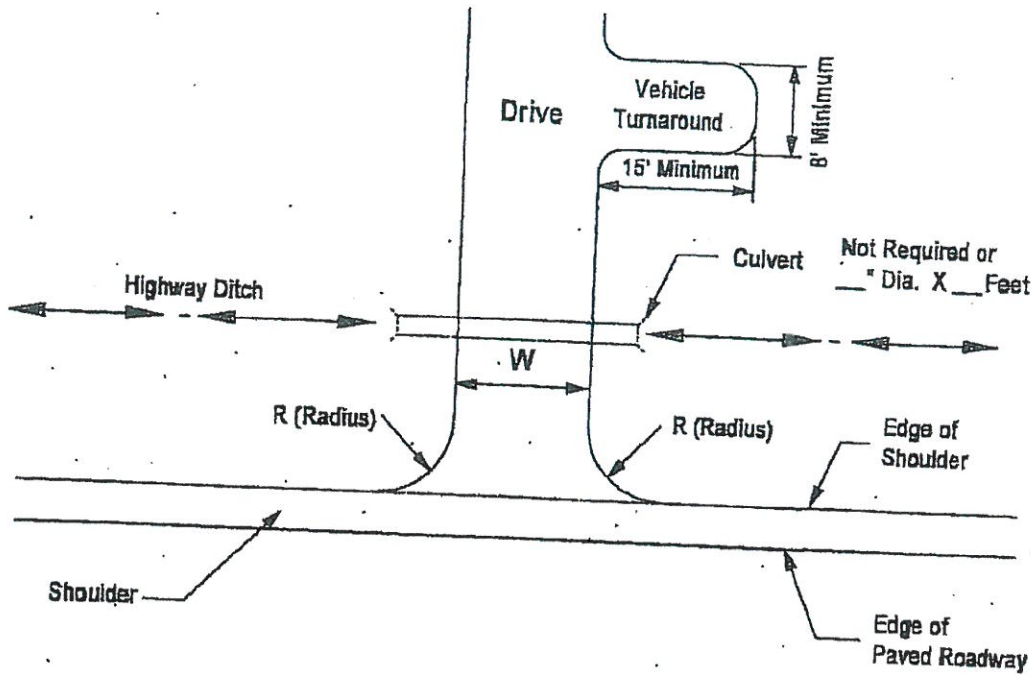

GENERAL NOTES -

1. ALL RESIDENTAL OR COMMERCIAL DRIVES WITH 10% GRADE OR MORE SLOPING DOWN TOWARDS THE HIGHWAY SHALL BE PAVED TO THE RIGHT OF WAY LINE, AS A MINIMUM, INCLUDING SHOULDER, IF GRAVEL AND HAVE DITCHES TO CONTROL RUNOFF.
2. DRIVES SLOPING TO THE HIGHWAY SHALL BE CROWNED (.1/2" PER FT. MINIMUM).
3. TO THE MAXIMUM EXTENT PRACTICAL, THE ENTRANCE MUST BE CONSTRUCTED PERPENDICULAR TO THE HIGHWAY AT THE POINT OF ACCESS. EXCEPT WHERE CURBING EXISTS OR IS PROPOSED, THE MINIMUM RADIUS ON THE EDGES OF THE ENTRANCE MUST BE 10 FEET OR AS OTHERWISE REQUIRED AS SHOWN.
4. ENTRANCES/DRIVEWAYS WILL BE BUILT WITH AN ADEQUATE TURN-AROUND AREA ON SITE TO ALLOW ALL VEHICLES TO MANUVER AND PARK WITHOUT BACKING ONTO THE HIGHWAY. THIS TURN-AROUND SHALL BE AT LEAST 8 FEET WIDE BY 15 FEET LONG.
5. ENTRANCES/DRIVEWAYS AND OTHER ASSOCIATED SITE WORK WHICH DIRECTS WATER (RUNOFF) TOWARD THE HIGHWAY MUST BE CONSTRUCTED, CROWNED STABILIZED AND MAINTAINED WITH MATERIALS AND APPROPRIATE TEMPORARY/PERMANENT EROSION CONTROL MATERIALS IN ACCORDANCE WITH MOOT BEST MANAGEMENT PRACTICES.
6. THE PROFILE OF THE ENTRANCES MUST COMPLY WITH THE DETAILS SHOWN ON PAGE 2.

17

MDOT Entrance / Driveway Details, Continued

PROFILE Details

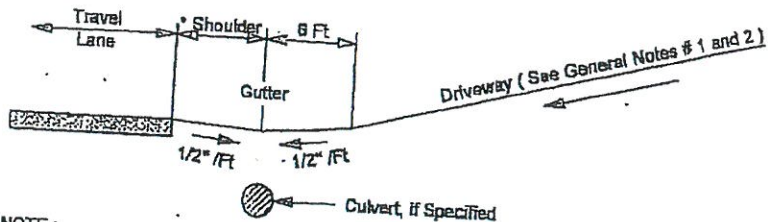

NOTE:
Grade of Existing Shoulder Should Be Maintained To Create A Gutter
With a Minimum Of Three Inches Below The Edge Of Traveled Way.
* Distance Of The Gutter From The Edge Of Traveled Way Should Be
The Same As Existing Shoulder Or A Minimum Of 4 Feet.

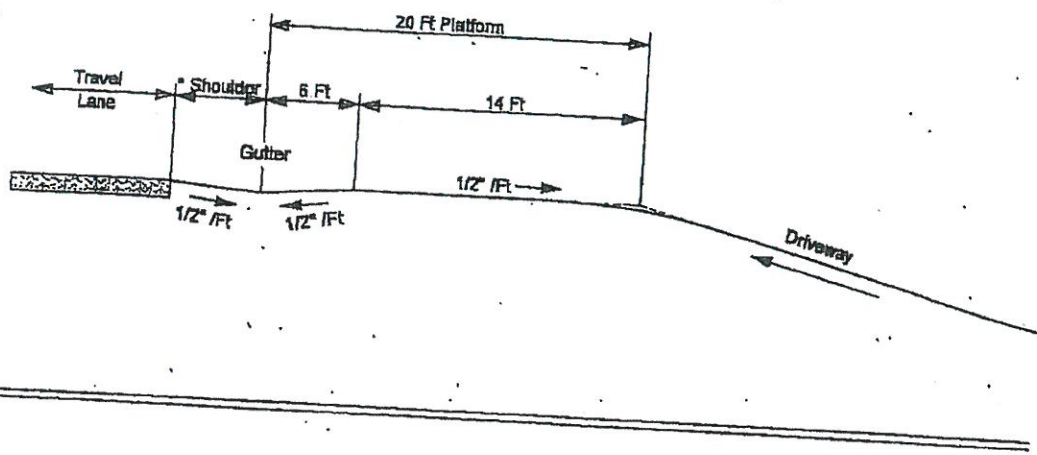

Driveway Cross Section

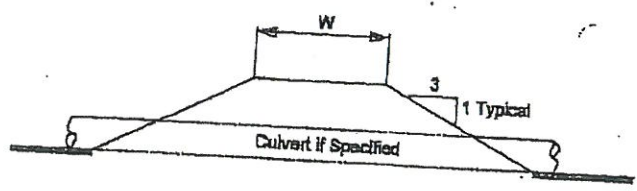

18

April 20, 2017

Wes Sunderland
Code Enforcement Officer
Town of Baldwin
534 Pequawket Trail
West Baldwin, Maine 04091

Re: Proposed Bulk Oil Storage Facility
Route 113
West Baldwin, Maine
St.Germain Collins File No.: 4076

Dear Mr. Sunderland:

St.Germain Collins, on behalf of D&D Oil, is submitting this Application For Conditional Use Permit for a proposed bulk oil storage facility on a portion of a 42-acre parcel on Route 113 in West Baldwin (see Site Location Map).

The facility will include two 20,000-gallon horizontal steel storage tanks for No. 2 fuel oil, diesel, and kerosene. One tank will be a dual-compartment tank for storage of diesel and kerosene. The tanks will be located on cradles inside a concrete containment dike measuring approximately 35 feet by 40 feet by 5 feet high (depressed approximately 4 feet into the ground). The dike floor will be sloped to a corner sump where storm water in the dike will be collected and pumped to an area onsite for infiltration into the ground.

In addition to the concrete containment dike, there will be a loading rack located over a concrete pad measuring approximately 12 feet by 40 feet. The pad will slope to a centrally located catch basin that drains into the diked area. Oil delivery trucks will be filled under the loading rack and the 20,000-gallon tanks will be filled from tanker trucks parked at a dedicated off-loading area located under the rack. The pumps and the majority of the oil piping will be located inside the diked area. The facility layout is shown on the enclosed Site Plan.

Power to the pumps will be accessed inside a small locked storage shed located near the loading rack (exact location to be determined). Only D&D Oil drivers will have keys to unlock the storage shed. Spill equipment (e.g., absorbent pads, booms, etc.) will also be stored inside the shed. One dusk to dawn light will be installed at the facility.

EXPERIENCE YOU CAN RELY ON
WHEN IT COUNTS

19

The facility will be accessed from a single gravel entrance/exit off Route 113. The remainder of the truck access around the dike will comprise compacted gravel. A chain or bar gate will be located at the entrance approximately 75 feet off Route 113. No nuisances such as noise, dust, odor, vibration, glare, smoke, or litter are anticipated at the facility. A fire extinguisher will be present and maintained at the facility at all times. In addition, all D&D Oil trucks carry fire extinguishers.

The facility will be constructed such that stormwater at the facility will sheet flow off the gravel access areas into existing wooded and partially wooded buffer areas. No additional stormwater will flow off the property.

An application for an aboveground storage tank permit from the Office of State Fire Marshal has been submitted. Additionally, prior to facility operation, and as required by the Environmental Protection Agency, a Spill Prevention, Control and Countermeasure Plan will be prepared for the facility. No other permits or approvals are being sought at this time.

We look forward to presenting the application to the Planning Board at their April 27, 2017 meeting. Please do not hesitate to contact us should you have any questions or require additional information.

Sincerely,
ST. GERMAIN COLLINS



Scott D. Collins, P.E.
Managing Principal

enclosures

cc: Dale Verrill - D&D Oil

20



Maine Department of Transportation

Paul R. LePage
Governor

Driveway/Entrance Permit

David Bernhardt, P.E.
Commissioner

Permit Number: 18366 - Entrance ID: 1

OWNER
Name: Dale Verrill
Address: 14 Mountain View Avenue
Brownfield, ME 04010
Telephone: (207)935-3834

Date Printed: May 03, 2016

LOCATION

Route: 0113X, Pequawket Trail
Municipality: Baldwin
County: Cumberland
Tax Map: 5 Lot Number: 16
Culvert Size: 15 inches
Culvert Type: metal/plastic
Culvert Length: 34 feet
Date of Permit: May 02, 2016
Approved Entrance Width: 24 feet

In accordance with rules promulgated under 23 M.R.S.A., Chapter 13, Subchapter I, Section 704, the Maine Department of Transportation (MaineDOT) approves a permit and grants permission to perform the necessary grading to construct, in accordance with sketch or attached plan, an **Entrance to Commercial Industrial** at a point **1810 feet East from Pigeon Brook Road / west end at GPS coordinates: 43.807240N, -70.731400W**, subject to the Chapter 299 Highway Driveway and Entrance Rules, standard conditions and special conditions (if any) listed below.

Conditions of Approval:

This Permittee acknowledges and agrees to comply with the Standard Conditions and Approval attached hereto and to any Specific Conditions of Approval shown here.

(G = GPS Location; W = Waiver; S = Special Condition)

G - THE ENTRANCE SHOULD BE LOCATED AT GPS COORDINATES: 43.807240N, -70.731400W.

S - In the town of Baldwin on the southerly side of Route 113 / Pequawket Trail, approximately 1810 feet easterly of the west end of Pigeon Brook Road and approximately 35 feet easterly of utility pole 237.

S - The culvert shall be aluminum coated corrugated metal pipe (Type 2) or HDPE smoothbore plastic pipe. Ditching may be required and shall be of sufficient depth and length so that water flows smoothly into and out of the pipe and no standing water results. The Property Owner must call MaineDOT at (207)642-2787 prior to entrance and culvert installation to arrange for an inspection.

S - The entrance shall be paved, at a minimum, from the edge of the existing highway pavement to the edge of the highway right-of-way.

Approved by: Anthony Fontaine Date: 5-03-2016

5/3/2016

21



State of Maine Department of Transportation Entrance / Driveway Details

PLAN

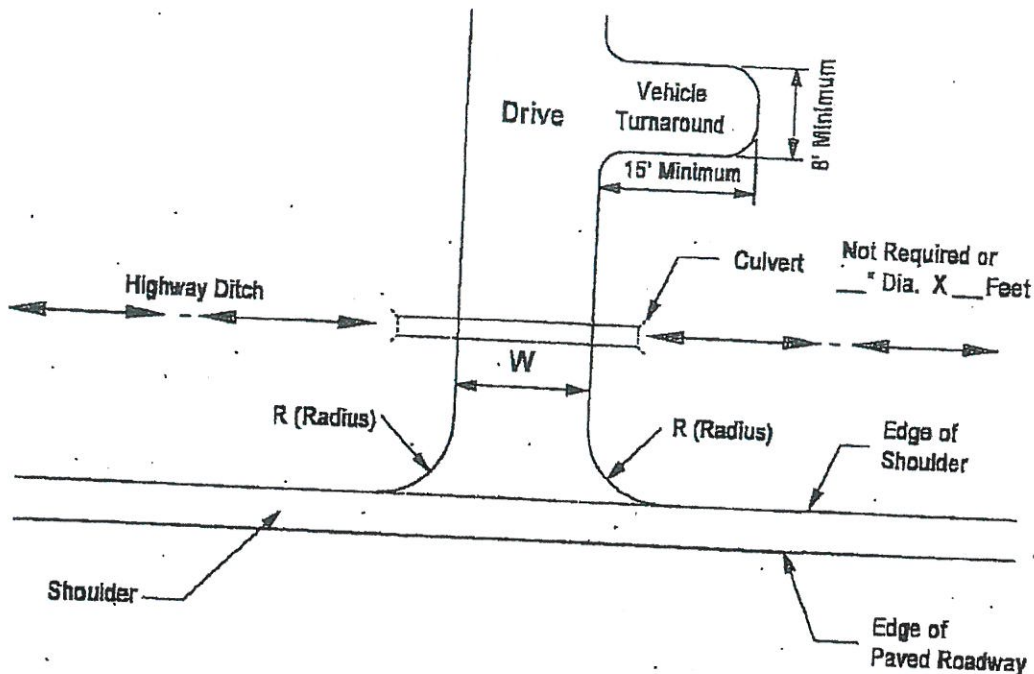

GENERAL NOTES -

1. ALL RESIDENTAL OR COMMERCIAL DRIVES WITH 10% GRADE OR MORE SLOPING DOWN TOWARDS THE HIGHWAY SHALL BE PAVED TO THE RIGHT OF WAY LINE, AS A MINIMUM, INCLUDING SHOULDER, IF GRAVEL AND HAVE DITCHES TO CONTROL RUNOFF.
2. DRIVES SLOPING TO THE HIGHWAY SHALL BE CROWNED (.1/2" PER FT. MINIMUM).
3. TO THE MAXIMUM EXTENT PRACTICAL, THE ENTRANCE MUST BE CONSTRUCTED PERPENDICULAR TO THE HIGHWAY AT THE POINT OF ACCESS. EXCEPT WHERE CURBING EXISTS OR IS PROPOSED, THE MINIMUM RADIUS ON THE EDGES OF THE ENTRANCE MUST BE 10 FEET OR AS OTHERWISE REQUIRED AS SHOWN.
4. ENTRANCES/DRIVEWAYS WILL BE BUILT WITH AN ADEQUATE TURN-AROUND AREA ON SITE TO ALLOW ALL VEHICLES TO MANUEVER AND PARK WITHOUT BACKING ONTO THE HIGHWAY. THIS TURN-AROUND SHALL BE AT LEAST 8 FEET WIDE BY 15 FEET LONG.
5. ENTRANCES/DRIVEWAYS AND OTHER ASSOCIATED SITE WORK WHICH DIRECTS WATER (RUNOFF) TOWARD THE HIGHWAY MUST BE CONSTRUCTED, CROWNED STABILIZED AND MAINTAINED WITH MATERIALS AND APPROPRIATE TEMPORARY/PERMANENT EROSION CONTROL MATERIALS IN ACCORDANCE WITH MDOT BEST MANAGEMENT PRACTICES.
6. THE PROFILE OF THE ENTRANCES MUST COMPLY WITH THE DETAILS SHOWN ON PAGE 2.

MDOT Entrance / Driveway Details, Continued

PROFILE Details

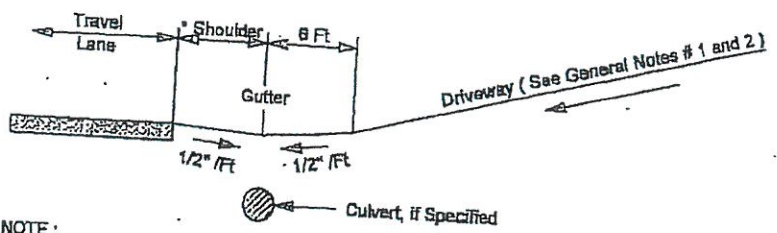

NOTE:
Grade of Existing Shoulder Should Be Maintained To Create A Gutter With a Minimum Of Three Inches Below The Edge Of Traveled Way.
* Distance Of The Gutter From The Edge Of Traveled Way Should Be The Same As Existing Shoulder Or A Minimum Of 4 Feet.

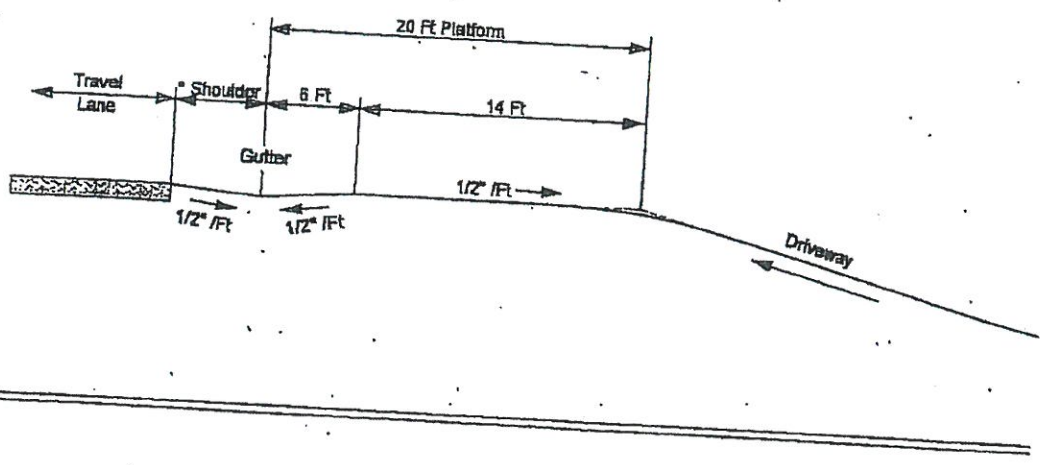

Driveway Cross Section

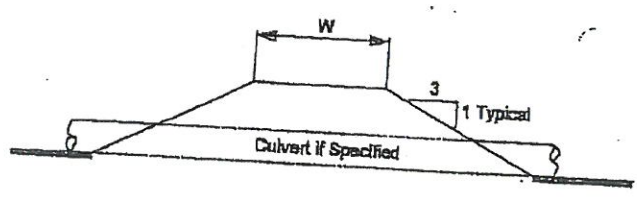

23

Doc#: 14527 BK:33014 Pg: 76

WARRANTY DEED

Joanne M. Ward of West Baldwin, Cumberland County, Maine, and Tracey A. Batchelder of Naples, Cumberland County, Maine, and Susan V. Gagnon of Litchfield, Kennebec County, Maine, and Jacob M. Ward of Hudson, Penobscot County, Maine, and Derek L.V. Ward of Corinth, Penobscot County, Maine, and Gabrielle W. Kennedy of Bangor, Penobscot County, Maine, for consideration paid, grant to Dale A. Verrill and Debra F. Verrill of Brownfield, Oxford County, Maine, whose mailing address is 14 Mountain View Road, Brownfield, ME 04010, with Warranty Covenants, as Joint Tenants, the land in the Town of Baldwin, Cumberland County, Maine, more particularly described in Exhibit A attached hereto and incorporated herein by reference.

MAINE REAL ESTATE TAX PAID

WITNESS our hands and seals this 30 day of April, 2016.

Joanne M. Ward
Joanne M. Ward

Tracey A. Batchelder
Tracey A. Batchelder

Susan V. Gagnon
Susan V. Gagnon

Jacob M. Ward
Jacob M. Ward

Derek L.V. Ward
Derek L.V. Ward

Gabrielle W. Kennedy
Gabrielle W. Kennedy

STATE OF MAINE

Notary, ss.

30 March, 2016

Then personally appeared the above named Joanne M. Ward and acknowledged the foregoing instrument to be her free act and deed.

Hal J. Tippetts
Notary Public, State of Maine
My Commission Expires
February 2, 2020

Before me,

Notary Public/Attorney at Law

Printed or Typed name of Notary:
Commission Expiration: 2-2-20

p.3
24

Received
Recorded Register of Deeds
Apr 01, 2016 10:28:11A
Cumberland County
Nancy A. Lane

EXHIBIT A

"[A]certain tract of land situated in Baldwin in said County of Cumberland and bounded: Northerly by the highway leading past the former site of the Baldwin Town House and now known as the Pequawket Trail; Southerly by the highway leading from the Pigeon Brook School House past the former site at the Old Baldwin Railroad Station; Easterly by land now or formerly of Richard F. Chase and Westerly by the lot of land on which Pigeon Brook School House stands.

This deed is made subject to such encumbrance as may be imposed by the right of way of the P. & O. Railroad Company."

Meaning and intending to convey and hereby conveying all and the same land described in the deed of Lyndon S. Ward to David H. Ward dated July 29th, 1997, recorded in Book 13304, Page 321 of the Cumberland County Registry of Deeds. Also reference deed of William S. Lord and Rebecca G. Marsh to Harry F. Ward and Walter J. Mackey, dated December 18, 1940 and recorded in Book 1626, Page 182 of the said Registry of Deeds.

Excepting from the land described above are the following parcels of land:

Property conveyed to Charles and Hazel Black by deed dated September 5, 1956, and recorded in Book 2332, Page 323 of said Registry of Deeds;

Property conveyed to Paul A. and Tracy A. Batchelder by deed dated July 29, 1997, and recorded in Book 13304, Page 322 of the said Registry of Deeds;

Property conveyed to Paul S. Morse, by deed dated May 21, 1973, recorded in Book 28217, Page 307 of said Registry of Deeds;

Property conveyed to Tracey A. Batchelder by deed dated September 28, 2010, recorded in Book 28152, Page 189 of said Registry of Deeds.

The Grantors herein derive their title by descent and are all of the heirs at law of the late David H. Ward, of Baldwin, who died intestate on July 2, 2011. David H. Ward was survived by his wife Joanne M. Ward, daughter Tracey A. Batchelder and daughter Susan V. Gagnon. David H. Ward and Joanne M. Ward had a third child, son Michael Ward, who predeceased David H. Ward, having passed away in 1997. At the time of Michael Ward's death, he was unmarried and was survived by all of his three children, Derek L.V. Ward, Jacob M. Ward, and Gabrielle W. Kennedy.

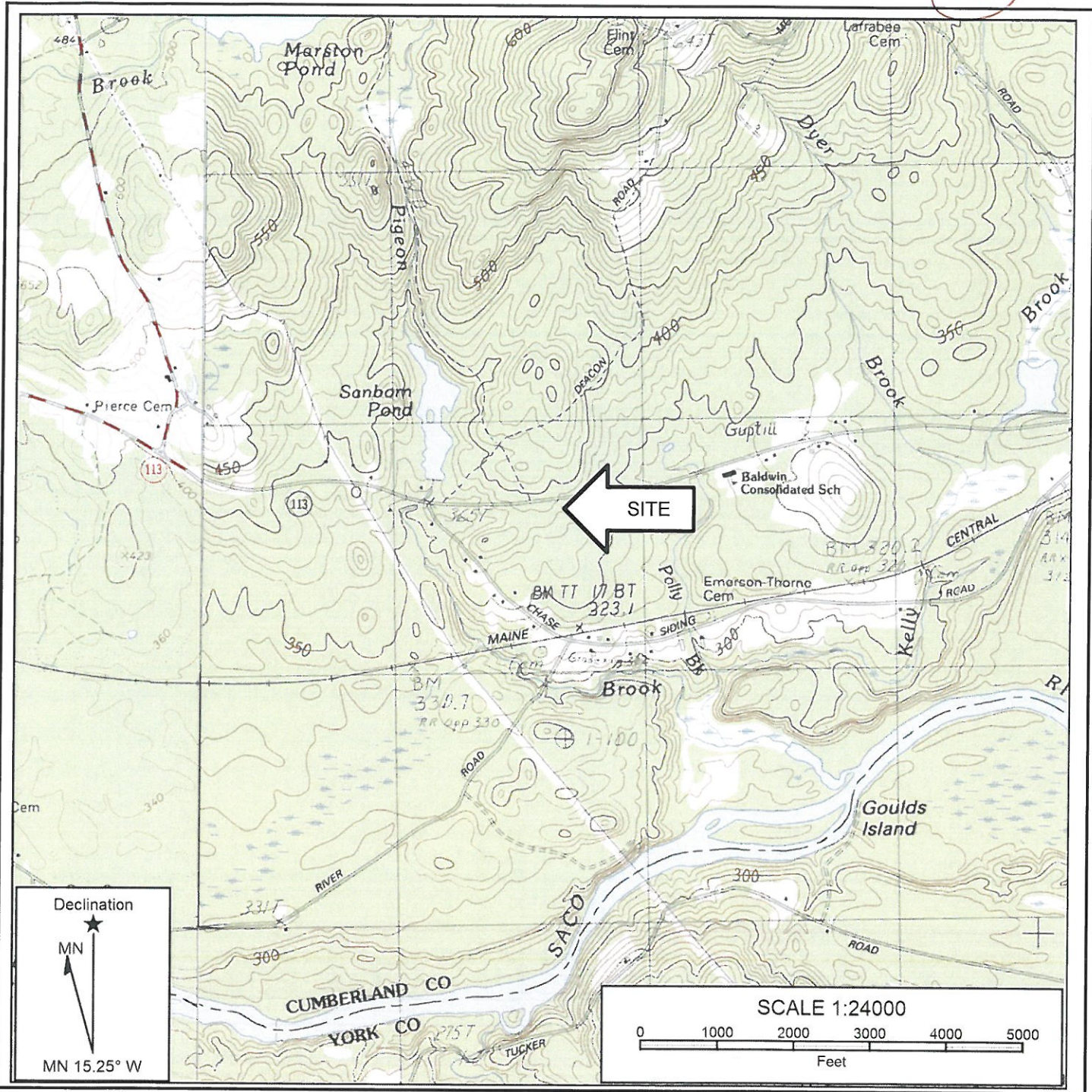

SOURCE: USGS MANCHESTER MAINE
TOPOGRAPHIC MAP, 1982.

SITE LOCATION MAP
D&D OIL
534 PEQUAWKET TRAIL
WEST BALDWIN, ME

D&D OIL
14 MOUNTAIN VIEW AVENUE
BROWNFIELD, ME 04010

St.Germain • Collins

FIGURE
1

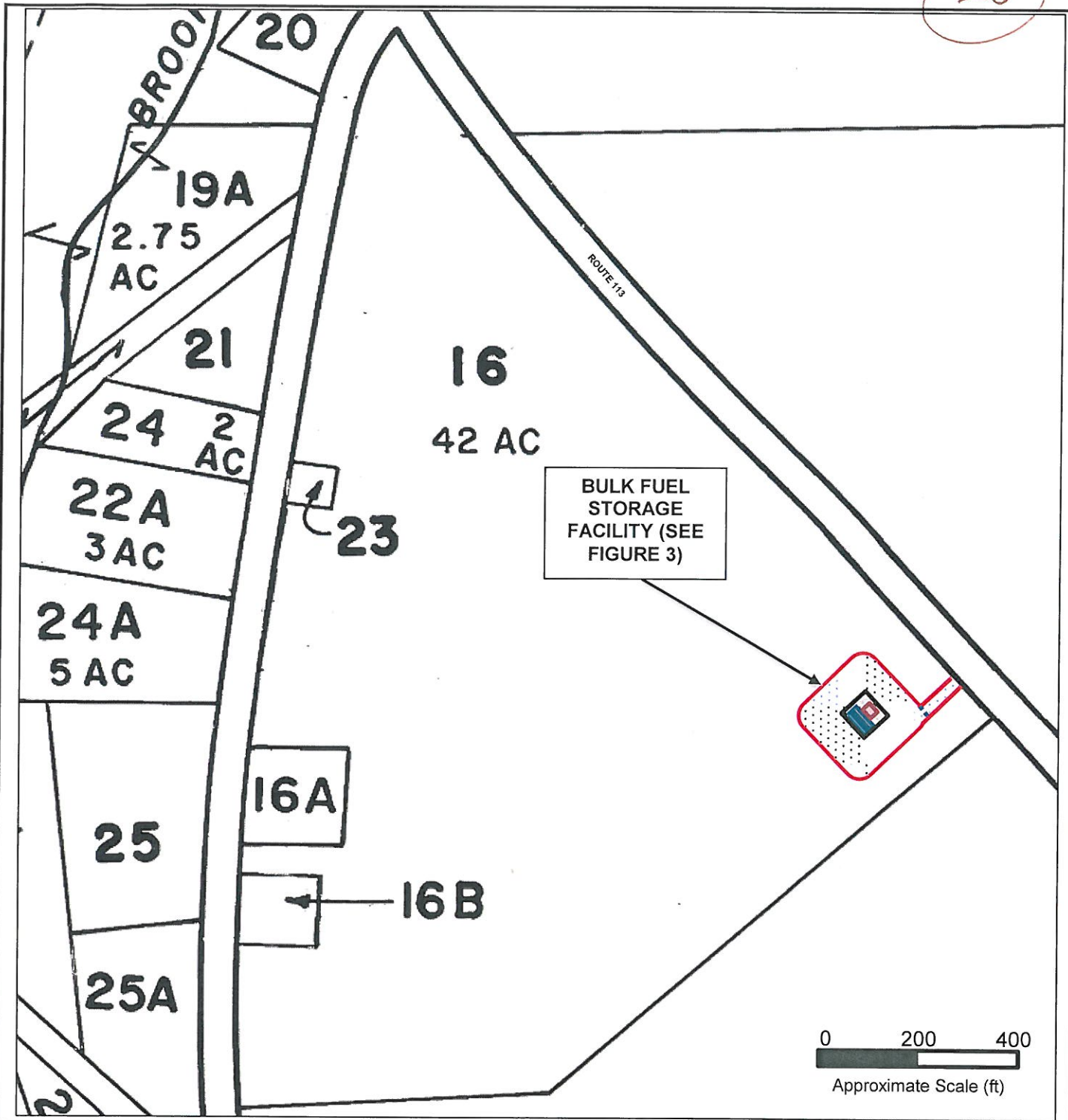

REFERENCE: TOWN OF BALDWIN, MAINE - TAX MAP 5, LOT 16

— FACILITY BOUNDARY (APPROX.)

LOT PLAN
 D&D OIL
 534 PEQUAWKET TRAIL
 WEST BALDWIN, ME

D&D OIL
 14 MOUNTAIN VIEW AVENUE
 BROWNFIELD, ME 04010

St. Germain • Collins

FIGURE
 2

29

16

42 AC

23

16B

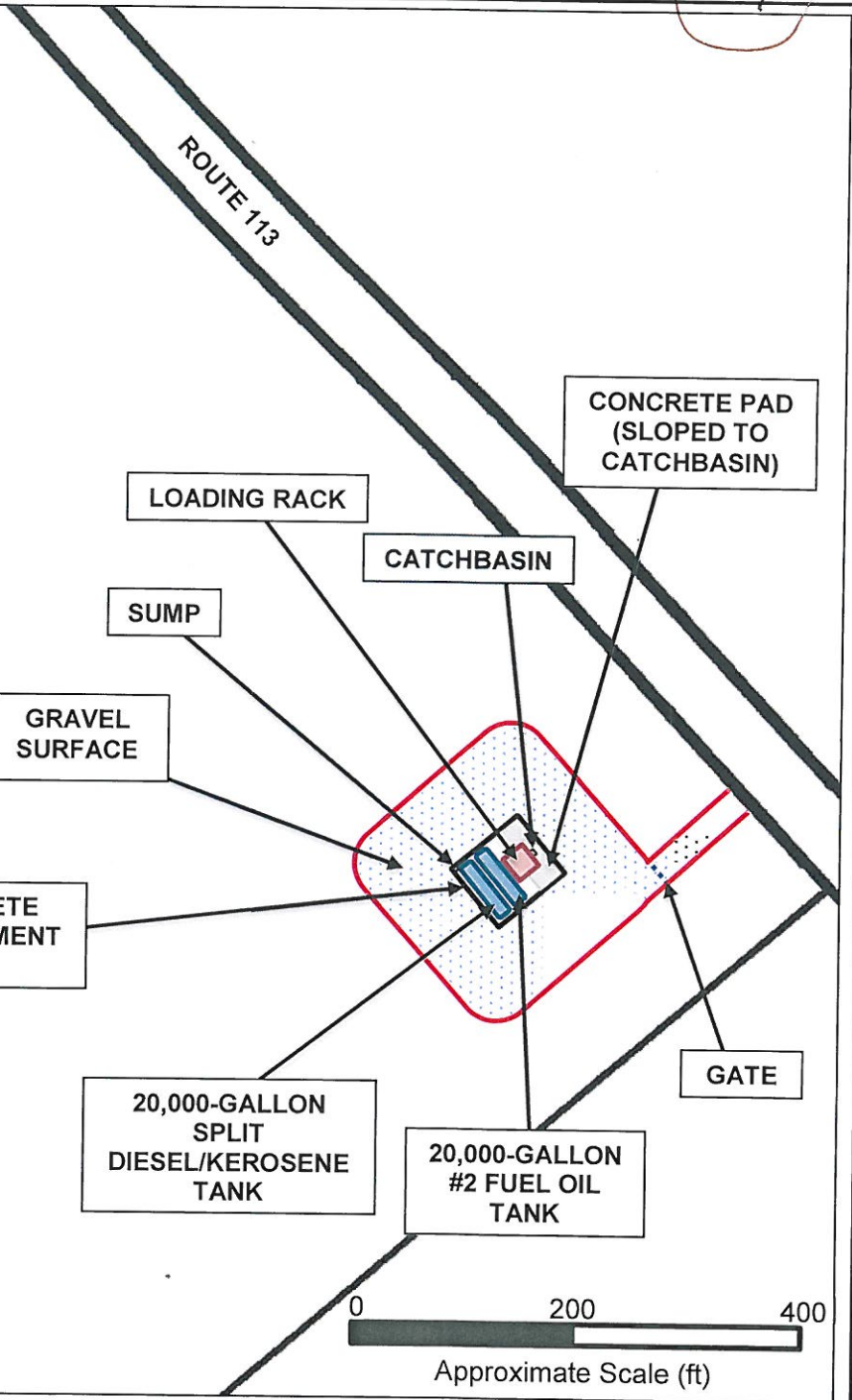

REFERENCE: TOWN OF BALDWIN, MAINE - TAX MAP 5, LOT 16

 FACILITY BOUNDARY (APPROX.)



SITE PLAN

D&D OIL
534 PEQUAWKET TRAIL
WEST BALDWIN, ME

D&D OIL
14 MOUNTAIN VIEW AVENUE
BROWNFIELD, ME 04010

St. Germain • Collins

FIGURE
3

11

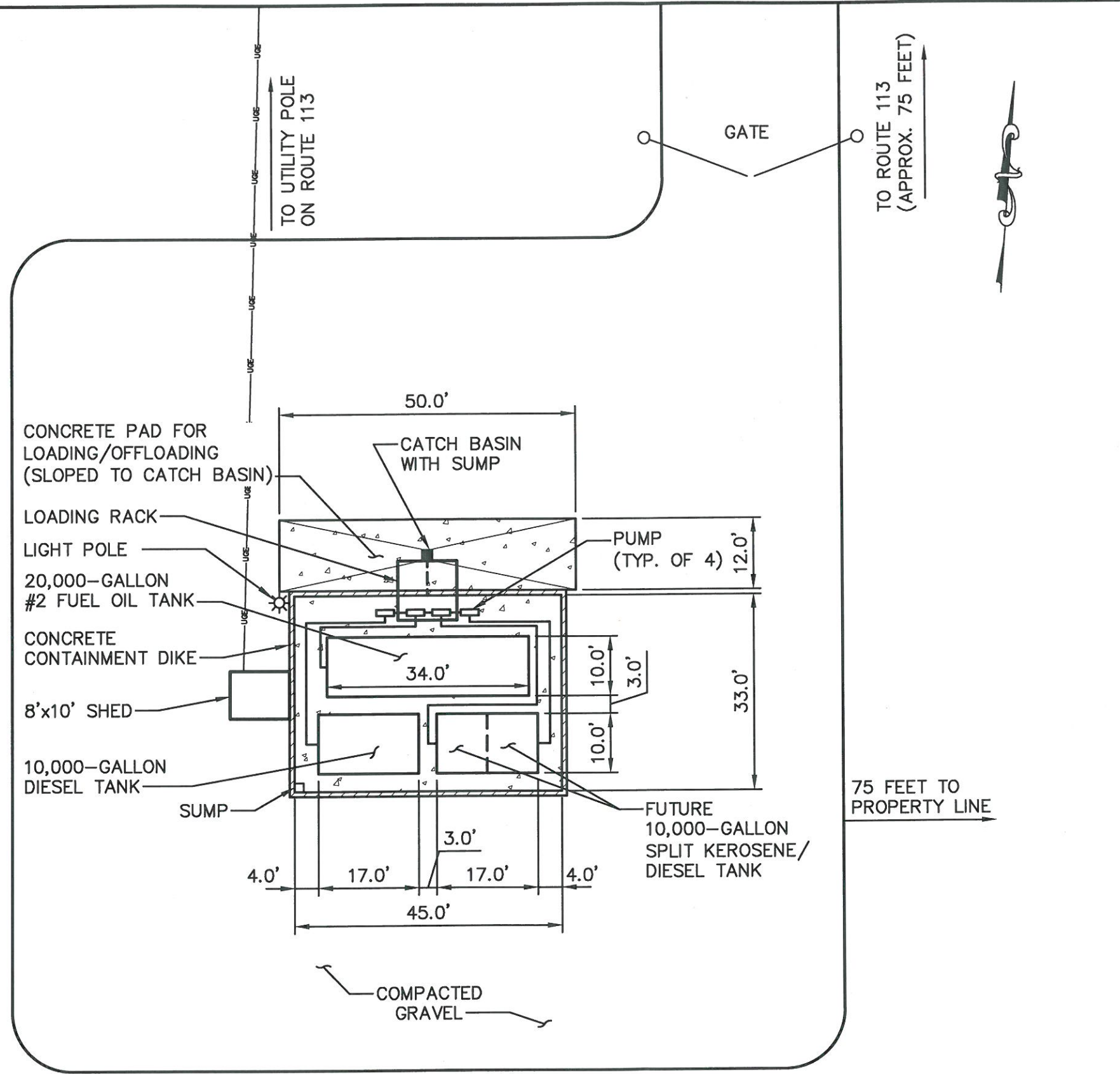

LEGEND:

NOTES:

THE PURPOSE OF THIS PLAN IS FOR TOWN OF BALDWIN CONDITIONAL USE PERMIT AND MAINE DEPARTMENT OF PUBLIC SAFETY STATE FIRE MARSHAL OFFICE ABOVE GROUND STORAGE TANK PERMIT.

SITE PLAN

D&D OIL
534 PEQUAWKET TRAIL
WEST BALDWIN, MAINE

D&D OIL
14 MOUNTAIN VIEW AVENUE
BROWNFIELD, ME 04010

St. Germain • Collins

FIGURE 4

PLAN VIEW

SCALE: 1"=20'

NOTE:
COMPACTED GRAVEL AREA
IS NOT DRAWN TO SCALE.

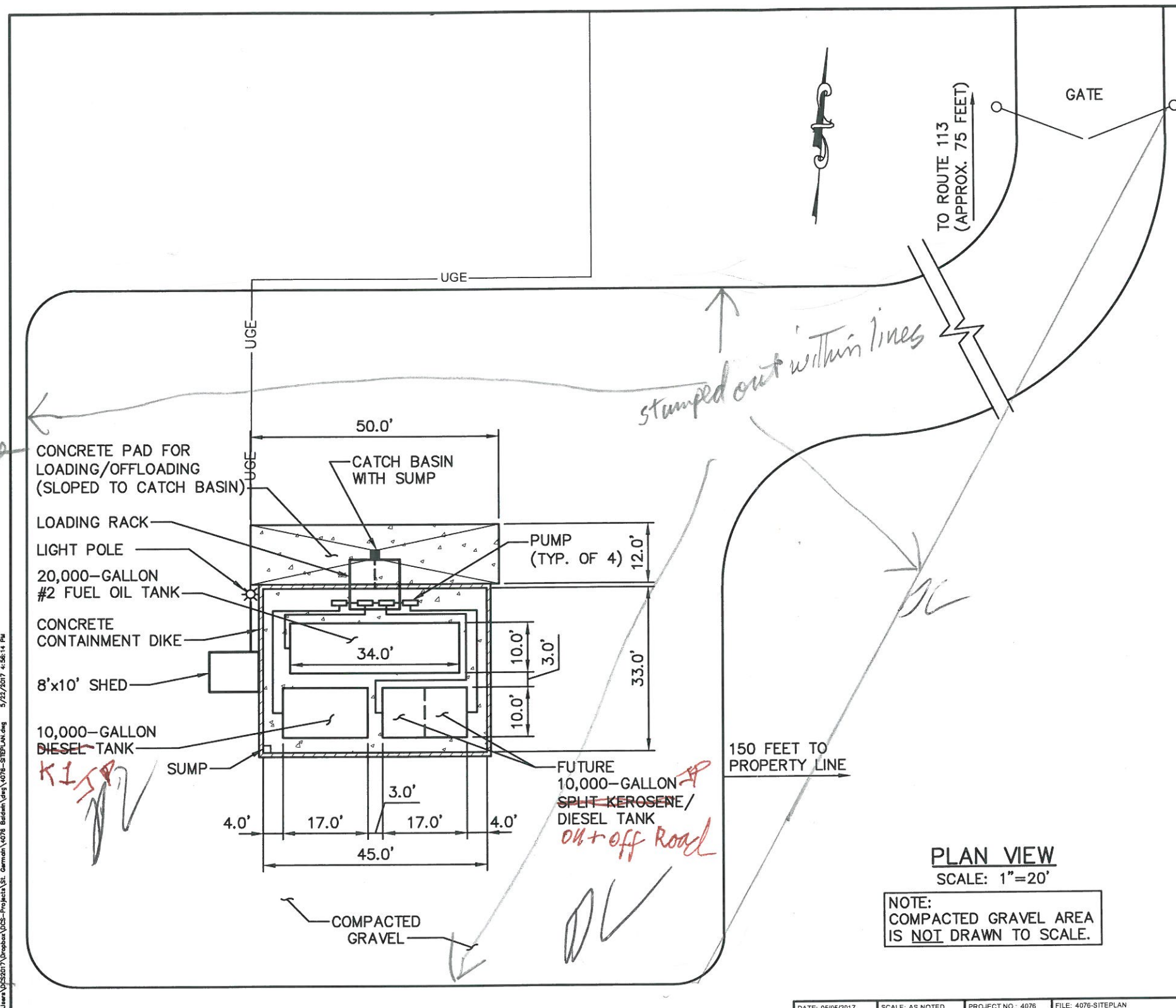

gravelled stamped area shall be 200 feet x 200 feet

stamped out within lines

- CONCRETE PAD FOR LOADING/OFFLOADING (SLOPED TO CATCH BASIN)
- LOADING RACK
- LIGHT POLE
- 20,000-GALLON #2 FUEL OIL TANK
- CONCRETE CONTAINMENT DIKE
- 8'x10' SHED
- 10,000-GALLON DIESEL TANK
- SUMP
- CATCH BASIN WITH SUMP
- PUMP (TYP. OF 4)
- 34.0'
- 10.0'
- 3.0'
- 10.0'
- 33.0'
- 4.0'
- 17.0'
- 3.0'
- 17.0'
- 4.0'
- 45.0'
- 50.0'
- 12.0'

KISA

FUTURE 10,000-GALLON SPLIT KEROSENE/DIESEL TANK out off Road

COMPACTED GRAVEL

150 FEET TO PROPERTY LINE

PLAN VIEW
SCALE: 1"=20'

NOTE: COMPACTED GRAVEL AREA IS NOT DRAWN TO SCALE.

LEGEND:

NOTES:

THE PURPOSE OF THIS PLAN IS FOR TOWN OF BALDWIN CONDITIONAL USE PERMIT AND MAINE DEPARTMENT OF PUBLIC SAFETY STATE FIRE MARSHAL OFFICE ABOVE GROUND STORAGE TANK PERMIT.

SITE PLAN

D&D OIL
534 PEQUAWKET TRAIL
WEST BALDWIN, MAINE

D&D OIL
14 MOUNTAIN VIEW AVENUE
BROWNFIELD, ME 04010

St. Germain • Collins

FIGURE 4

C:\Users\jcs2017\OneDrive\Projects\St. Germain\4076 Baldwin\4076-SITEPLAN.dwg 5/22/2017 4:58:14 PM

D&D Oil CUP Conditions

- The gate should be at least 100 feet off of the road (Route 113).
- Post DEP spill-reporting phone number by gate so it is visible in case of spills.
- Ensure field is stumped out adequately and drivable so trucks have room to move around and especially so emergency crews have room to operate in the event of a spill or fire.
 - N.B. Reference St.Germain-Collins Figure 4 (page 8) in CUP (initialed by applicant) East Gate post to SE corner – clear out that triangle.
- Plant and maintain a double-staggered row of ≥ 6 foot white pines as a visual barrier between the facility and the road.
- Tanks painted in a matte finish – consider light grey vs. primer red.
- Provide copy of SPCC to Baldwin Fire Chief
- Hours of operation are 24x7
- Lighting must be low intensity from dusk to dawn to prevent light pollution and all lighting should directed be inward and downward, including all lighting on rack.
- It is proposed that there be no limit to truck traffic.
- Any signage must be less than 20 square feet. 10 square feet recommended.
- No painting of company names or logos on tanks that would be noticeable from the road.
- Obey all State and Federal laws
- Provide a copy of State Fire Marshall permit to Town.
- D&D Oil should provide an annual statement via mail on the date of the CUP approval attesting that the containment unit is in good working order.
- All of the applicants submissions are included in the CUP and the statements contained therein are material to the CUP unless modified in writing by the Planning Board.
- The Town Fire Department must be notified within 24 hours of any spill.

- D&D Oil shall provide proof of liability insurance, specifically for the Bulk Oil Storage facility to the Town.
- D&D Oil should take reasonable efforts to minimize back-up alarms.
- Standard Conditions: (attached)

STANDARD CONDITIONS FOR CONDITIONAL USE

To the Applicant: These Standard Conditions will apply to your conditional use approval. To the extent applicable, these conditions are *additional to* and supplement any specific provisions which the Planning Board may have imposed upon your approval.

1. The Applicant shall carry on the permitted activity in accordance with the description thereof in the application, and in accordance with the documentary and/or testimonial representations presented by the Applicant in connection with the proceeding. Substantial compliance with the description of the activity and representations is a condition of Approval. Any undisclosed and unapproved use of the premises (even if otherwise accessory to the approved use), or any substantial deviation from the activity or representations described in connection with this Approval shall be deemed a violation of the Land Use Ordinance, and may result in revocation of the Approval.
2. By acceptance of this Conditional Use Approval, the Applicant consents to the inspection by the Code Enforcement Officer of all non-residential areas of the premises at reasonable times (with or without prior notice) for the purpose of determining compliance with the conditions of the Approval or any provision of local, state, or federal law. This consent shall not be withdrawn unless the Applicant abandons the approved use, and notifies the Town in writing delivered to the CEO that the activity will not be resumed without a further approval by the Planning Board. Failure to allow any such inspection by the CEO may result in revocation of the Approval.
3. If the Approval is specifically conditioned upon physical improvement of the premises, obtaining of insurance, or other requirement, the activity authorized hereunder shall not be commenced until the Applicant demonstrates compliance with each of the conditions to the CEO, and receives a certificate of occupancy from the CEO evidencing that all conditions have been met. Commencement of the approved activity prior to obtaining such certification may result in revocation of the Approval. Failure to utilize or maintain such physical improvement, insurance, or other requirement thereafter may result in revocation of the Approval.
4. The Approval shall lapse and become null and void if the use authorized by the Approval is not commenced within one (1) year of the date of approval, or if the use is abandoned for a period of one (1) year thereafter. Where there is good cause for the delay, or the discontinuance, and there is no evidence of intent to abandon the use, these requirements may be extended for additional periods not to exceed one (1) year.
5. The Planning Board may schedule a hearing (upon reasonable notice to the Applicant and the public) to determine whether: there is a violation of the Approval or any the condition thereof (including those contained herein); or any other violation of any provision of local, state, or federal law. If the Board determines that a violation has occurred and is either continuing or is likely to recur, the Board may rescind this approval or take such other action to amend or modify the Approval as the Board deems appropriate to protect the public health, safety, or welfare.

*Donald Harrington
P.O. Box 1803
Edgartown, MA 02539*

To: Josiah Pierce
Vice Chairman, Baldwin Planning Board
Town of Baldwin
534 Pequawket Trail
West Baldwin, ME 04091

Re: D & D Oil bulk oil storage facility

Dear Mr. Pierce,

My wife and I own the property at 609 Pequawket Trail, across Rt. 113 from the proposed storage facility. Our son Nik is building a home on the property.

Unfortunately, we did not receive sufficient notice to be able to attend the public hearing and were not aware of the cause for concern that this facility presents. My son Nik, who moved to our property on May 8th, did attend the May 25th meeting and shared what he learned.

Here are our thoughts:

First is the location. The traffic along that stretch of road is of major concern. From both directions, trucks travel at a high rate of speed down the hill and then accelerate to go up the other side. Adding more trucks will not only acerbate the noise issue, but will also create a hazard when trucks attempt to exit the proposed facility, especially to go up the hill. A collision with a loaded truck would be catastrophic—Especially with Pigeon Brook at the bottom of the hill.

Facility safety: there should be locks on all tanks. Further, who will manage an emergency at the unstaffed facility in the event of an accident?

Screening: the purpose of the screening is to hide the tanks from view of the road. It seems incongruous to even consider the holding tanks to be painted red (even in a matte finish). These tanks are not to be seen from the road, so why not insist that they be painted to blend with the environment—grey, green or brown.

In addition to the ten trees specified, there should be more trees on the downhill side of the facility, to fully screen the tanks from view, as there appears to be inadequate screening on that side.

Lighting: I understand the lighting requirement is to be “in and down” and that the lights will be red. I would add that they be on a motion sensor or manual switch with timer, so that the lights are on only when the facility is being used, not 24/7.

Hours of operation: A letter dated May 9th to Wes Sunderland, from St. Germain Collins on behalf of D & D Oil, specified “the facility will be used from 6:00 AM to 8:00 PM Monday through Saturday”. Without clear understanding the committee has extended this to 24/7. With residences within earshot of the facility, the hours that they have asked for should be enforced. It will be troublesome for residents to have to hear the increased noise, but having that noise at night and on Sundays would be an intolerable situation.

I do understand that because of the propane depot up the street being allowed to have night deliveries, D & D has been given that same approval. But limiting them to the hours they have requested would offer some protection to the current and future area residents.

Property Values: This, of course, will affect property values. Not only for those who live nearby, but also for value of land that has yet to be built on.

I am a small business owner, I understand wanting to grow a business, but this is not the location for a facility like this. It should be away from a watershed, and it should be in an area where it will not affect the quality of life of the people who live, or want to live, near it. Further, if this is allowed in that location, it needs to be strictly regulated.

Thank you,

Don and Betsy Harrington