

# AutoCAD in 20 Hours

AutoCAD and AutoCAD LT  
2016

Version 2016

**James Beebe**

Building Designer, Drafter,  
Building Contractor,  
Construction Consultant

**Structural Press**

Copy Right 2016

All Rights Reserved

ISBN 978-0-9848631-3-6



## Preface to AutoCAD in 20 Hours

Try the first chapter for free at: [www.AutoCADin20Hours.com](http://www.AutoCADin20Hours.com)

**This book is for all types of 2d drafting—mechanical, circuitry, as well as architecture.** It uses a project—drawing a set of house plans—as a format for learning AutoCAD. This is an excellent way to learn because this project utilizes all the features that are necessary for drafting any object. After completing this course you will be able to draft anything in 2d and print it to scale. This is an enjoyable way to learn because it is project orientated and the drafting begins immediately. The drawing evolves quickly; this creates a feeling of rapid progress. This is quite different from other manuals that require many hours of learning in preparation for drafting.

This book is a carefully designed **programmed learning system** where every sentence has been crafted to fall into the proper order. The instructions build upon each other step by step to make the process flow naturally. Great attention has been paid to including every step of each process in plain English. Jargon has been avoided as much as possible. It is designed for people who wish to learn how to draft, not for the computer wunderkind.

Many of you will agree with the statement that help menus are often of little help. The same can be said of many software manuals. There are several reasons for this.

First, the language is often incomprehensible. The writers know how to use the software, but they don't know how to speak in plain English.

Second, steps are omitted from the instructions, often the first step(s). The writer assumes that the reader knows some of the steps.

Third, many manuals are presented in encyclopedic format. They list the various procedures, commands, and functions in sections without context. And they try to cover the entire program even though only a portion of the program is essential to most users. The essential information is buried in a sea of relatively unimportant information. **We don't need to know how to do everything in these programs; we just need to know enough to get the job done.**

Fourth, because we don't know the jargon, we can't ask for help. Without the words we can't formulate the questions.

This book addresses all of these problems. It goes straight for the **goal: how to draw any 2d object in AutoCAD.** It does this by guiding the reader through the creation of a set of house plans with every step illustrated and described in plain language.

This makes for a dynamic learning experience because the drawing begins to take shape in the first pages and progresses at a rapid pace. The floor plan in Chapter 1 is completed in four to six hours.

But don't take my word for it—try it for free and decide for yourself. Find it on the book website.

Visit the book website at: [www.AutoCADin20Hours.com](http://www.AutoCADin20Hours.com)

I hope you enjoy this experience, it is meant to be fun. That is: if drawing stuff is your idea of a good time.

**Note on appropriate version:** This is the updated 2016 version of **AutoCAD in 20 Hours**. AutoCAD doesn't change a lot from year to year but if you have an older version of the program you may want to use the original edition of AutoCAD in 20 Hours that covers the years from 2006 to 2014 or the second edition which is 2015. These can be found at the website listed above

# Table of Contents

<b>Preface</b>	
<b>Introduction</b>	<b>i</b>
<b>Chapter One, Floor Plans</b> Setup and Basic Commands (Line, Offset, Trim), Dimensions, Text, Layers, Design Center	<b>1</b>
<b>Chapter Two, Elevations</b> More Basic Commands, Some Advanced Commands (Hatch, Divide, Spline), Properties	<b>51</b>
<b>Chapter Three, Foundation</b> More Basics, Dashed Lines, Scales, Leaders	<b>87</b>
<b>Chapter Four, Plot Plan</b> Coordinates, Nodes and Splines, Arcs	<b>105</b>
<b>Chapter Five, Cross Section and Details</b> Scaling in Model Space, Drawing Techniques	<b>121</b>
<b>Chapter Six, Plotting</b> Plotter Setup, Paper Space, Viewports, Scales in Viewports, Plot on 24 x 36 Paper, Plot on 8.5 x 11 Paper, PDF files	<b>141</b>
<b>Chapter Seven, Plotting the Detail Page</b> Scaling of Text, Dimensions and Leaders for Plotting in a Single Viewport	<b>157</b>
<b>Chapter Eight, Plot the Plot Plan</b> Import Screen Shots, Raster Files, Plotting Dashed Lines, More Text and Dimension Scales, Plot Scales	<b>169</b>
<b>Chapter Nine, Title Block</b> Prepare Border and Title Block	<b>181</b>
<b>Chapter Ten, Plot Sheets</b> Prepare Nine Pages of Plans for Plotting	<b>189</b>
<b>Chapter Eleven, Line Spacing and Shading</b> Fill, Line Spacing with Properties	<b>195</b>

<b>Chapter Twelve, Tables</b>	<b>201</b>
Table Setup and Variables	
<b>Chapter Thirteen—Scales</b>	<b>207</b>
Scales in Model Space and Paper Space, Metric System	
<b>Chapter Fourteen—Multiple Viewports</b>	<b>221</b>
Plotting a Page with Multiple Viewports, Scaling Text, Dimensions, and Leaders	
<b>Chapter Fifteen—Complete Plans</b>	<b>231</b>
Completing the Pages of the Plans, All the Details and Views to Create a Set of Plans for Submission for Permit.	
<b>Chapter sixteen—Annotative Text, Dimensions, Leaders, and Misc. Stuff</b>	<b>261</b>
Using the Annotative Features, Standard Page Setup, Blocks, Xrefs, Clouding, Wipeout, System Options	
<b>Appendix I—General Help</b>	<b>267</b>
<b>Appendix II—Commands</b>	<b>287</b>
<b>Appendix IV—Complete Set of Plans</b>	<b>289</b>
<b>Index</b>	<b>303</b>

# Introduction

## READ THIS BEFORE YOU BEGIN

Often we skip the introductions because they contain a lot of promotional material and not a lot of substance. **This introduction contains important information.** Take a few minutes and read through it.

This book can be used to learn all types of 2d drafting—mechanical, circuitry, as well as architecture. It covers all of the procedures and commands to draw anything. It uses Imperial measurements because that is (unfortunately) what is still used today in the United States for Architecture. This should not be an impediment for metric drafters. All of the measurements are called out in exact numbers and **no math is required**. The conversion to metric is not difficult and is explained. It is the **drawing skills** that are important and this is an excellent method to learn those skills as architectural drafting covers almost every situation that will be encountered by any drafter.

The house drawn in this book is designed to facilitate the learning process. It is not meant to be an award winning design. Some design components are less than optimal to speed up the drawing process. It is a very small house so that each view can be printed on 8.5 x 11 paper and on a typical small printer. But the home is fully functional and could be built. The completed plans would pass inspection in any building department, though additional drawings and notes could be requested. Some jurisdictions would require engineering.

AutoCAD is a huge system. It can perform very complicated operations. But most of us do not need all the complex features. This book teaches the essentials, based on the concept that the drafter can then draw anything in 2d. More complex methods and procedures can be learned later.

The huge size of the AutoCAD program causes **glitches**. There are hundreds of system variable settings that can change through some glitch. Sometimes the program locks up. Sometimes, when opened, the settings from prior sessions will be lost. Sections of the drawing can become locked up and “unselectable”. The command line can disappear. It would take an entire book to catalog all of these possible glitches. This creates a problem for an instruction manual because it is not possible to predict when these glitches may occur.

Usually if things are not working, it is because the instructions are not being followed to the letter. But if there is a glitch, it can be difficult for the reader to evaluate.

If you are unable to obtain the demonstrated results, start by assuming that you have left out some part of the procedure. Read the text carefully and try again. Read the command line to see if the system is picking up on your input. If you still have a problem, see if there is an appendix listing for the command. Read Appendix I—Glitches. If you have access to the videos (see [www.AutoCADin20hours.com](http://www.AutoCADin20hours.com)), you can review the procedures there. If all else fails and you think that it might be a glitch, try restarting the program. If that fails you will have to research online for your problem. That should eventually produce the solution.

A very common glitch is that the system does not recognize the selection of a command when you click on a button. This seems to run in shifts—it happens for a while and then ceases to be a problem. When this happens **double click** the buttons. The problem should pass after a while and you can go back to a single click.

The system is setup for automatic saving. When the system **saves**, it **freezes** all actions. This can take a minute or more depending on the size of the file and the power of the computer. So, if you are drawing and the system freezes, wait a minute, it is probably saving your file.

Often, in the beginning, you will get stuck in the middle of some procedure and nothing seems to work; when this happens, use the escape button on your computer and start again. The escape button is a major tool in AutoCAD. Often you will see a blue or green rectangle on the screen and nothing will respond, use the escape.

**Read the command line** as you go through the different procedures. The prompts tell you what to do and you can see if your input matches the prompts.

**All of the drawing in this book is done in one file.** In other words: **do not create a new file for each chapter.** Open the same file each time and do all your drawing in the same workspace.

**Enter** means to hit the enter button on your keyboard (see Appendix I—Keyboard). **<e>**, **ent** and **enter** are all the same: press the enter key.

In the Imperial system the quote symbol (") means **inches**, the apostrophe symbol (') means **feet** as in 10' 4" (ten feet four inches).

You can **type commands** instead of clicking on the buttons. But if you do this you will have to type the command and then **enter**. Clicking on a button **equals** typing the command **and** hitting the enter key. This can be confusing because some procedures require clicking a button and then hitting the enter key. For these procedures, if you type that command, you will need to enter twice. You'll figure it out now that you have read this.

Many of the parts of the drawing are created **off to the side in open drawing space**. This means anywhere on the screen. These are meant to be copied or moved later, so the original location of these parts of the drawing is not important. Similarly a lot of the instructions indicate an approximate location for certain objects or text. **Approximate** means put it anywhere close to where it is depicted in the figure.

Don't worry about making things really precise. That is not an important aspect of this learning process. The idea here is to learn the drafting methods and procedures; precision is something that you can work out later. So if you are uncertain exactly where to place something, or exact dimensions, let it go and just keep moving forward with the lesson. Of course precision is essential to drafting, but that is something you can work out on your own.

The **Osnap** or Object Snap feature places your objects in a precise location that is marked by an icon that appears when your cursor approaches certain predetermined points. You don't need to understand this now; you will understand when it happens. If an Osnap icon is highlighted, your object will **attach to that point**. Sometimes this is not what you want and you will want to turn off the Osnap feature to resolve this problem.

Sometimes AutoCAD **switches layers automatically** (you will understand this later, also). Watch for this in the Layer Control window displayed on the first page of Chapter 1.

This book is meant to be used in a variety of ways. The two main distinctions are between the readers who want to just learn AutoCAD and those who wish to draft a full set of plans. The difference is mainly in Chapter 15. That chapter is for those who wish to complete the plans, everyone else can skip it. The book without Chapter 15 takes about twenty hours. The reader should be able to learn all of the skills for 2d drafting (of anything) in about that amount of time. The complete set of plans takes an additional fifteen to twenty hours because of the drafting labor.

Another variation in how this book can be used is that some readers will want to rely mostly on the illustrations and skip from one to the next. If you choose to use the book this way, you should still skim the **bold text** to make sure that you have not skipped over something essential.

**Try to complete the entire book in as short a time frame as possible.** This will insure that you retain the previously learned material as you move forward. If the study is stretched out over weeks or months it may require review or even starting over with the process. The best method would be to take a four day period and spend five hours a day. If you can learn AutoCAD in four or five days, it will be an accomplishment. It takes most people months or even years.

Draft long and prosper!



## Chapter 1—Setup and Floor Plans

Read the Introduction, before you begin, for some important general information.

### 1.1 Setup

Most books on CAD design begin with an extensive set up. This book takes a different approach. We will do the minimal amount of set up and start drawing. This will get things moving along and the set-up will be introduced as it is necessary to continue drawing. If you are unable to perform any of the tasks refer to Appendix I for trouble shooting.

When you first install AutoCAD you will see the screen in Fig 1-1. Yours will be black. This doesn't matter. I set my color scheme to white so it can be seen more clearly.

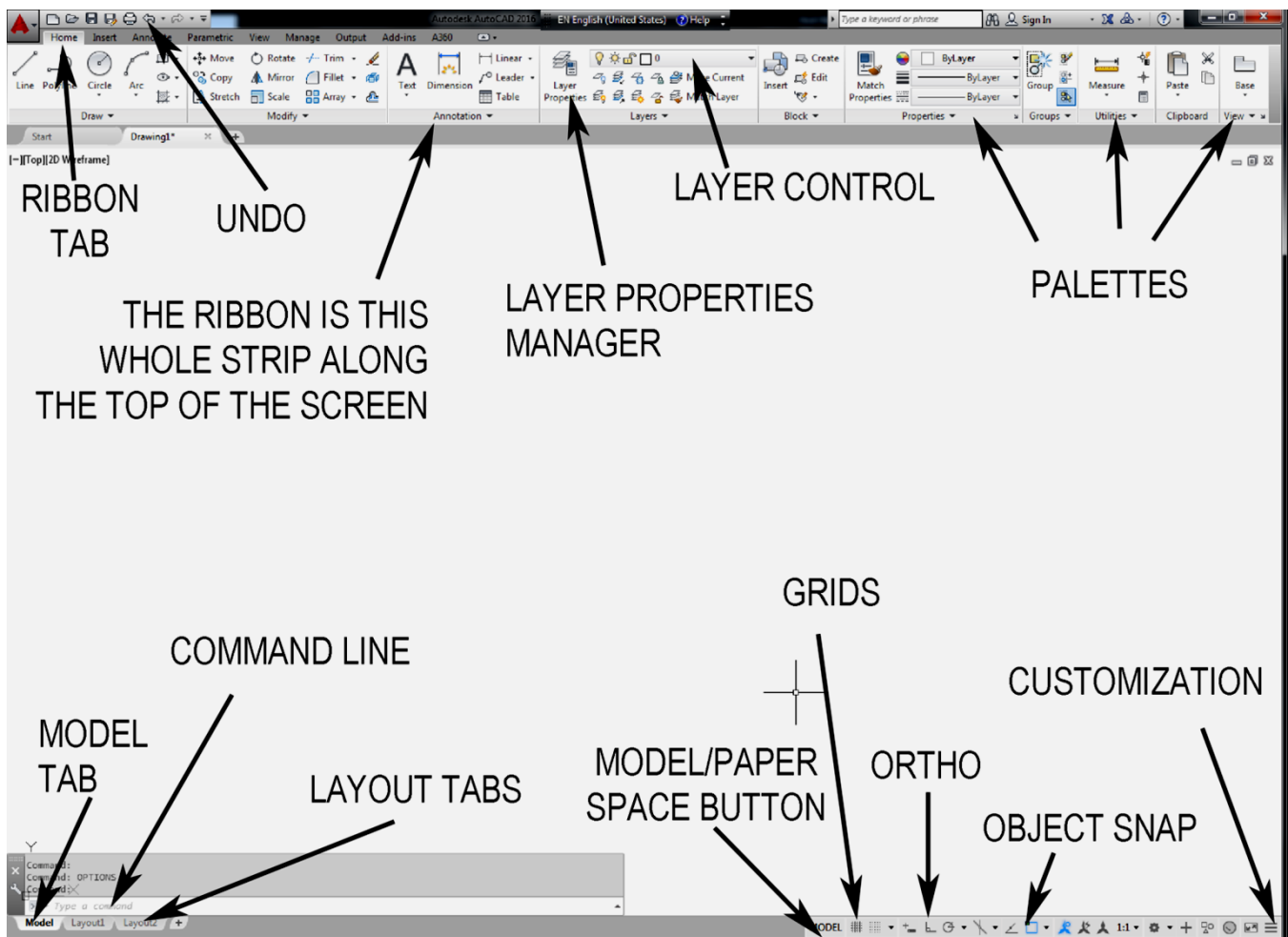

Fig. 1-1

If your screen displays boxes (not shown here) in the drawing area, close them by clicking on the x's.

If you see a different ribbon at the top of the screen, click on the Home tab. You may have more tabs than are shown here, don't worry about that for now. (If you want to add or eliminate tabs right click on a tab and select Show Tabs, then check or uncheck the tabs you want on the ribbon.)

The ribbon is the row of tools at the top of the screen as shown in Fig 1.1. There are a number of tabs along the top of the ribbon (Home, Insert, Annotate, etc.). If you click on these tabs you will see that a section of the ribbon opens that relates to the tab label. Within each section there are buttons associated with each command.

You do not need to know about these commands at this time as we will present them as they are needed to draw.

First we must set the measurement units to imperial standard for architectural drawing. AutoCAD will draw in metric or Imperial units. This book is written using the **imperial standard**—feet and inches. That is what is used for architectural drawing and construction work in the U.S.

Type **startup** (you will see the word appear in the Command line display, see Fig 1-1), hit **enter**. Type **1** then **enter**. This determines which menu you see when you open a new file.

Click on the AutoCAD icon in the upper left corner of your screen as shown in Fig 1-2. Select **New** at the top left corner of the screen. The pop up box shown in Fig 1-3 will appear (you may get a different box first, if so, click on the **quick set up** option to get this box).

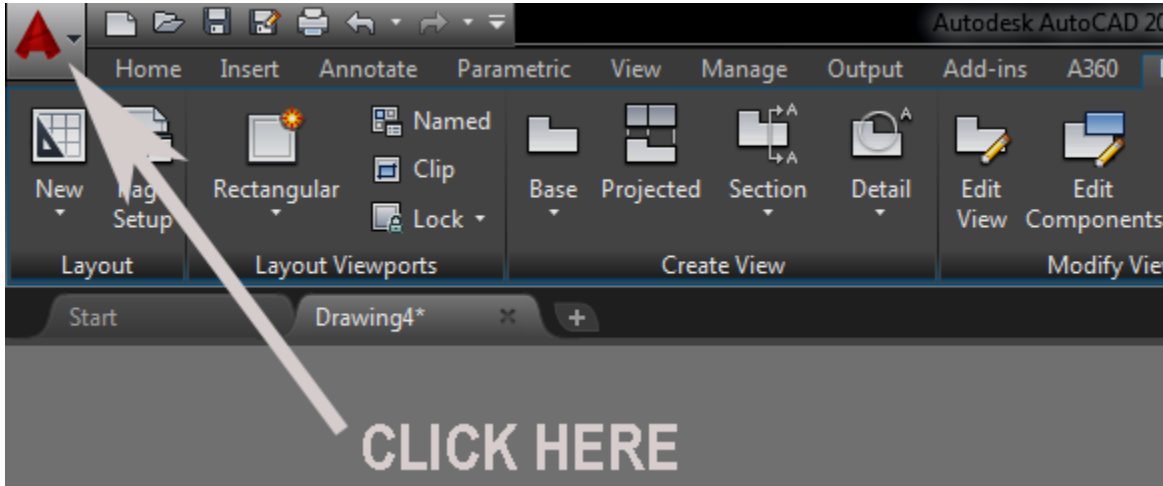

Fig. 1-2

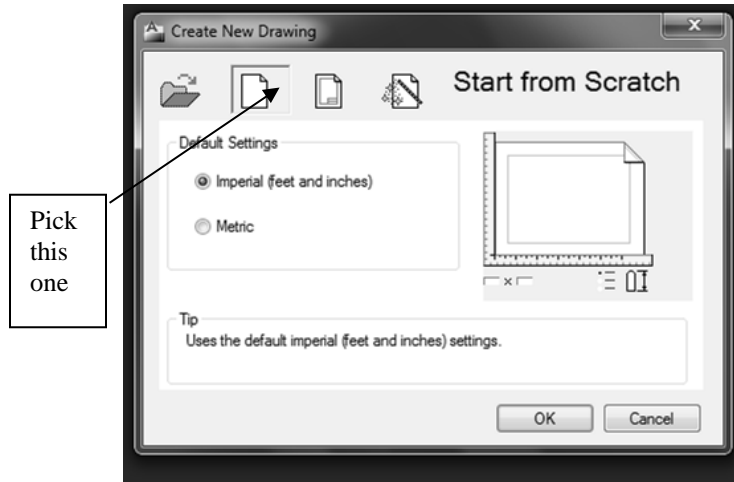

Fig 1-3

Click on the button shown in Fig 1-3.

Select the **Imperial (feet and inches)** button as shown.

Click **OK**.

If you need to know where to find a particular button use the F1 button, or type help. In the help homepage window that opens select **Commands**. There you will find an alphabetical list. Select the first letter of your command and scroll down until you find the command you are searching, click on that command and a box will open that shows the location of the button explains the process for its use.

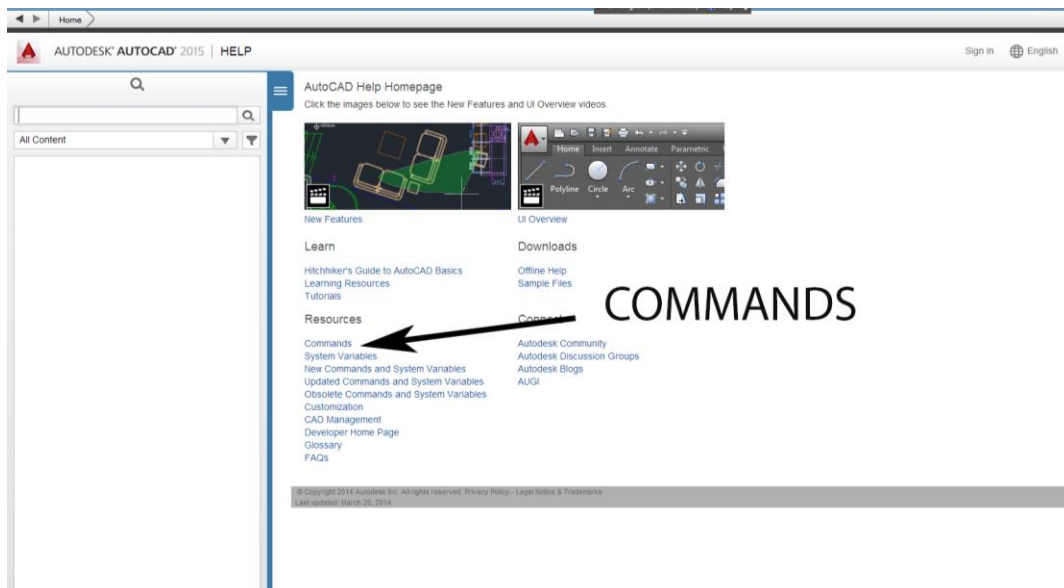
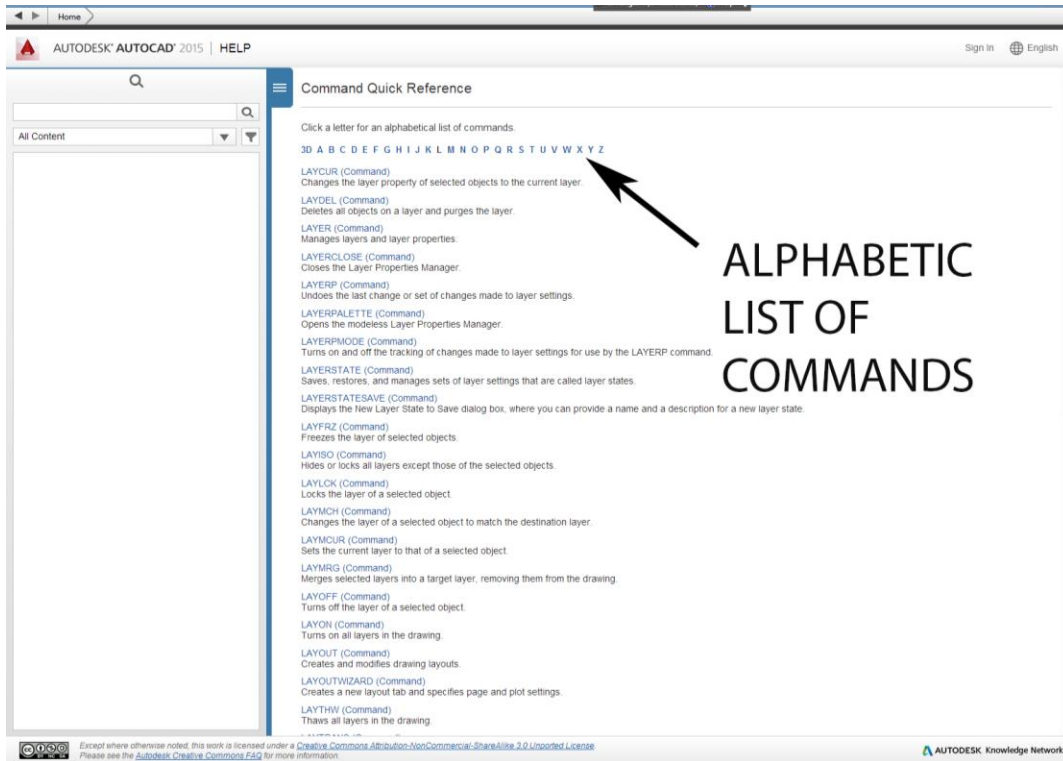

Fig 1-4



**Fig 1-5**

All the commands can be typed instead of clicking on the buttons (type the word for the command: **Line**, **Trim**, **Erase**, etc). However, if you type a command the procedures may be different than as described in this book. Most commonly you will need to press the enter key on your keyboard after you type the command. The **buttons equal: typed command + enter**. In this case the “enter” key sets the command in motion. Otherwise the typed command just sits in the command line waiting for some action.

If you lose the command line hold down the control button on your keyboard and press 9 on your keyboard. If this does not work type commandline and enter.

Down at the bottom of the screen you will see a row of buttons. If you **position** your **cursor** arrow **over** any of **them** and **do not click** (this is called: **hovering**) they will **tell you their names** (Fig 1-1). **Turn them all off, except the Ortho and the Object Snap** (we want these two turned on).

You can turn **Object Snap** on and off by pressing the **F3** key on your keyboard. The **Ortho** command can be turned on and off with the **F8** key. Object Snap is also called **Osnap**.

Now right click the **Object Snap** button. A selection box will open. Click on: **Open Object Snap Settings**.

A dialog box will open called **Drafting Settings** as shown in Fig 1-5A. Take a moment and look at the tabs at the top of this box. Here are the settings for the commands that are controlled by the buttons at the bottom of your screen as shown in Fig 1-1.

Select the **Object Snap** tab at the top. Turn on the following: **Endpoint, Midpoint, Intersection, and Perpendicular** (as shown by the leader arrows in **Fig 1-5A**). Turn off all other object snaps.

Click on the **OK** at the bottom to close the menu box.

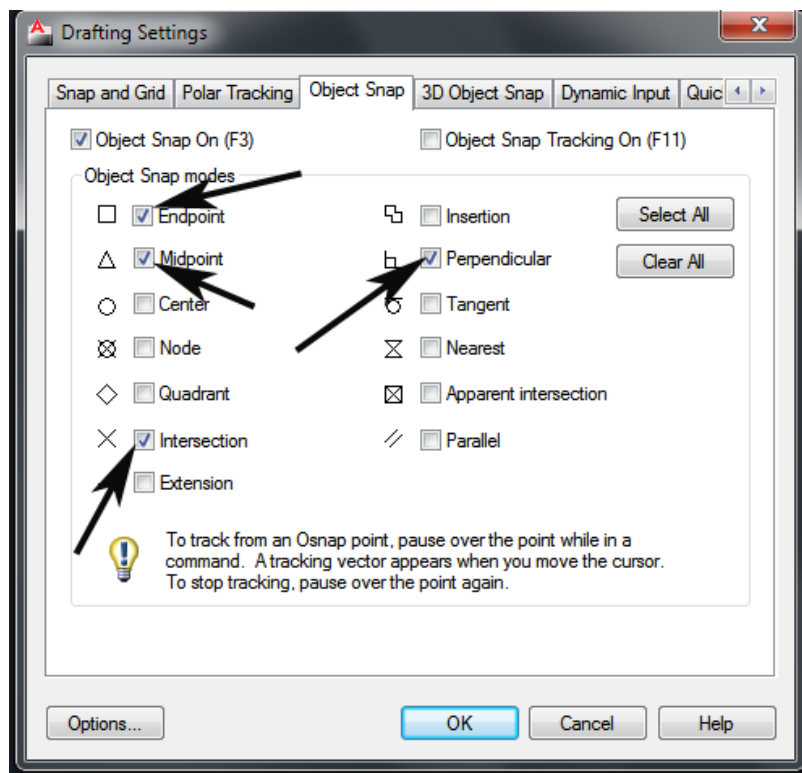

**Fig 1-5A**

Turn off the grids by clicking on the **Grid display** button in **Fig 1-1**.

## **1.2 Line**

We are ready to draw the floor plans. Before we begin take a quick look at the completed floor plan so you know what we are doing. You will find them at the rear of this book in Appendix IV. Look at the last figure in this chapter (Fig 1-63) to see the drawing we are going to draw in this chapter.

Before we begin an **important notice**: the apostrophe symbol ( ' ) represents feet in the Imperial system. The quote symbol ( " ) represents inches. As an example 12 foot is 12' and 6 inches is 6". 12 foot 6 inches is 12'6". **You must type the foot symbol after a number that represents feet** or you will get the default (which is inches). It is not necessary to type the inches symbol ( " ) because **inches is the default** (though it won't hurt to use this symbol).

Let us take a moment and turn off the **UCS**. This is the X and Y coordinates graphic in the lower left of the screen.

On the ribbon click on the View tab. All the way to the left you will see the UCS Icon button. Click on it. The USC will disappear from the screen.

Often AutoCAD does not set the units that you select in the start-up. Check to make sure they are set correctly by typing the word: **units**. When the Drawing Units window opens set the **Type** to **Architectural** and set the **Units to scale inserted content** to **inches**.

On the **Draw** palette click on the **Line** button (click the Home tab to see the Draw palette).

If strange things start to happen, or you get into trouble, hit the **Escape** on your keyboard, or click on the Undo button (Fig 1-1), and try again.

After you click the **Line** button, move your cursor over into the drawing area. It will turn into a cross. (If it doesn't look like a cross see Appendix I—Cursor.) Click anywhere in the drawing area and move the cursor down. You will see a line. (This line should be locked into the vertical—straight up and down—if it is not, you must turn on the Ortho as detailed above). Now type: **27'** and press the **enter** key. Press **enter** a second time.

Type: **zoom** (all you need to do is type the first letter **z**—many commands only require the first letter of the word).

At the **Command line** (Fig 1-1) at the bottom of the screen you will see a list of options. Type: **a** and **enter**. (As you type, look at the command line and read the prompts: **a** = all.)

Use your mouse wheel to zoom out a bit (see Appendix I—Mouse Wheel). You will see the vertical line you drew. It is 27 feet long. Sometimes this doesn't work when you first start a drawing and the line disappears when you enter. If you have a problem, see First Line in Appendix I.

Click on the **Line** button again. Position your cursor (the cross) at the upper end of the line and an object snap box will appear (Object Snap must be turned on). Click on this box. Move your cursor to the right a ways. You will see a horizontal line. Type: **22'** then **enter**. Do not enter a second time as you did before.

You will see a 22' line. Place your cursor near the right end of this line (the right side end) and pull a line down. (If this doesn't work click on the Line button again). Type: **27'** and **enter**.

Now position the cursor near the bottom of this line and draw towards the left. When you get near the end of the original first line you should see a snap object icon. Click on this icon and hit **enter**. You should see Fig 1-6.

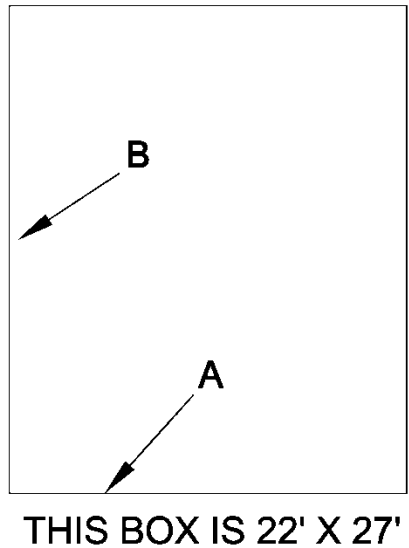

Fig 1-6

You do not need to click the Line button each time as long as the next line starts at the end point of the line you just drew. Just position the cursor near the end of the last line and pull out a new line in the direction that you want to draw. Watch the prompts that appear in the command line to see where you are in the sequence.

### 1.3 Offset

Click on the **Offset** button in the **Modify** section of the Home ribbon:



Type **5'** then **enter**. (Look down at the Command line when you type and read the prompts.) The cursor will turn into a box. Place that box over the lower horizontal line A in Fig 1-6. The line will illuminate; click on it. The cursor will turn back into a cross. Move the cursor up above line A a bit and click (anywhere above is fine). A new line will appear. It is 5 ft from the lower line. Press the escape key on the upper right corner of your keyboard.

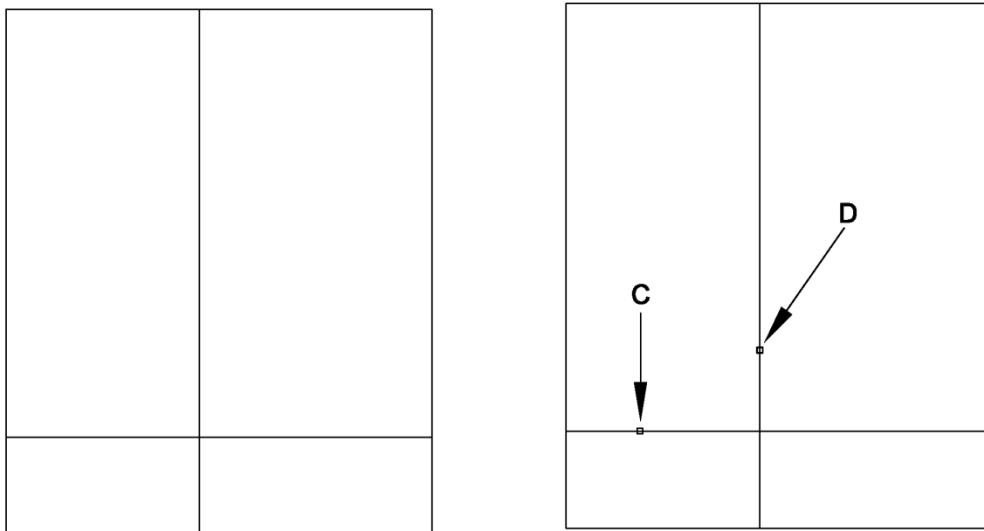

Fig 1-7

Click on the **Offset** button again. Type **10'** and **enter**. The cursor will turn into a box again. Position the box over the vertical line B in Fig 1-6. The line will illuminate. Click on that line. Move the cursor to the right a bit and click. A new vertical line will appear. Press the Escape key on your keyboard again. You will see the drawing on the left in Fig 1-7.

### **1.4 Trim**

Click the **Trim** button on the Modify palette (it is co-located with Extend, see Appendix II for help). Press **enter** (**from here on <e> will mean to hit the enter key**). The cursor will turn into a box again. Position the box on the center vertical line somewhere near the middle as in D in Fig 1-7. It will illuminate. Click on it. It will erase the upper part of the line, leaving the lower five foot section.

Press the Escape key on your keyboard. The cursor will return to a cross. (Note: you must press the **enter** key on your keyboard immediately after you click the **Trim** button for it to function in this manner. If you do not hit enter right after you click on the Trim button it works in a different way—see Appendix I-Trim for an explanation.)

Click on **Trim** then <e> again and this time click on the point indicated by **C** in **Fig 1-7**.

Click on the **Line** button again. Position the cursor (cross) over the upper right corner (E in Fig 1-8) of the rectangle and click. Move the cursor to the right a little and type: **12'** <e>. A new horizontal line will appear.

Move the cursor down from the far right of that new line a bit and type: **22'** <e>. From the bottom of this line move the cursor to the left and when it gets near point F in Fig 1-8 click on the osnap icon that appears. Press the **Escape** key again. You will have a drawing that looks like Fig 1-8.

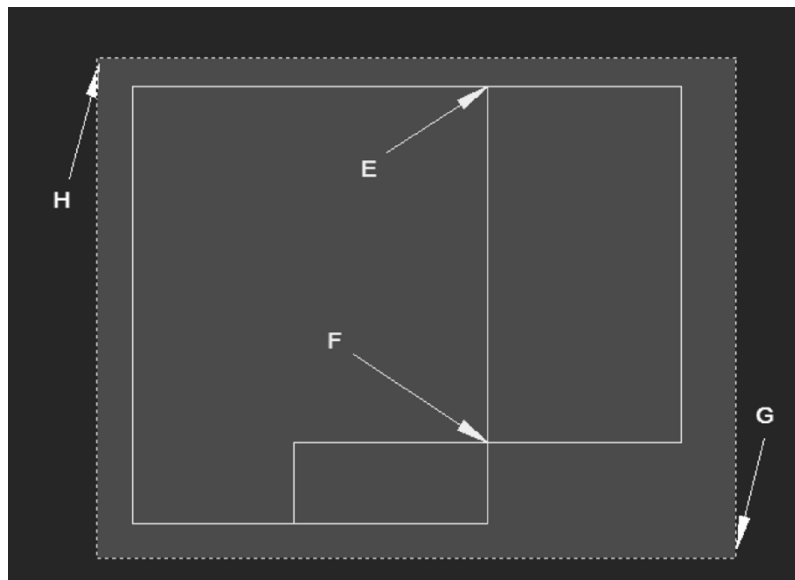

**Fig 1-8**

Zoom out by using the wheel on your mouse. (Sometimes AutoCAD locks up and won't scroll out. If this happens type: **zoom <e>** then: **a <e>**. Now the wheel should work.) Zoom out until the drawing is about a quarter as tall as the drawing area (see Fig 1-9).

Click on the **Copy** button On the Modify palette. The cursor will become a square (box). Position this cursor box to the right of the drawing a bit and down below the drawing a bit as shown by **G** in Fig 1-8. Press the left button



on the mouse, release the mouse button (the cursor box will disappear) move the mouse up and to the left. A **green** window will form. Enlarge the green box until it covers the entire drawing and **click at approximately H** in Fig 1-8. Completely cover the drawing with the green box before you click the left mouse button again. The lines covered by the green selection window will be highlighted and the little cursor box will reappear. This indicates that all the lines that were inside the green selection window have been selected. Press <e> (enter). Read the prompts.

Now position the cursor somewhere in the center of the drawing you just selected and click. **Move** the cursor to the left of the drawing a distance more or less as you see in Fig 1-9 and click then <e>. Use the mouse wheel as needed to zoom out. This will make two separate views of the drawing. Press the **Escape** key. You will have two drawings and they will look (more or less) like Fig 1-9.

## 1.5 Selection windows

When you cover items with the green shadow box, like we just did, you must include all the parts of the drawing to be selected within the green shading. See Appendix I—Selection Window for an explanation of this. (There are other ways of selecting elements to be copied that we will discuss later.) If you end up with only part of the drawing copied then you will need to erase or undo the flawed copy and try again. Use the Undo button at the top of the screen (or Ctrl Z which is the typed command for Undo).

This second copy of our drawing will be used later to create other views of the plans (ie: Foundation).

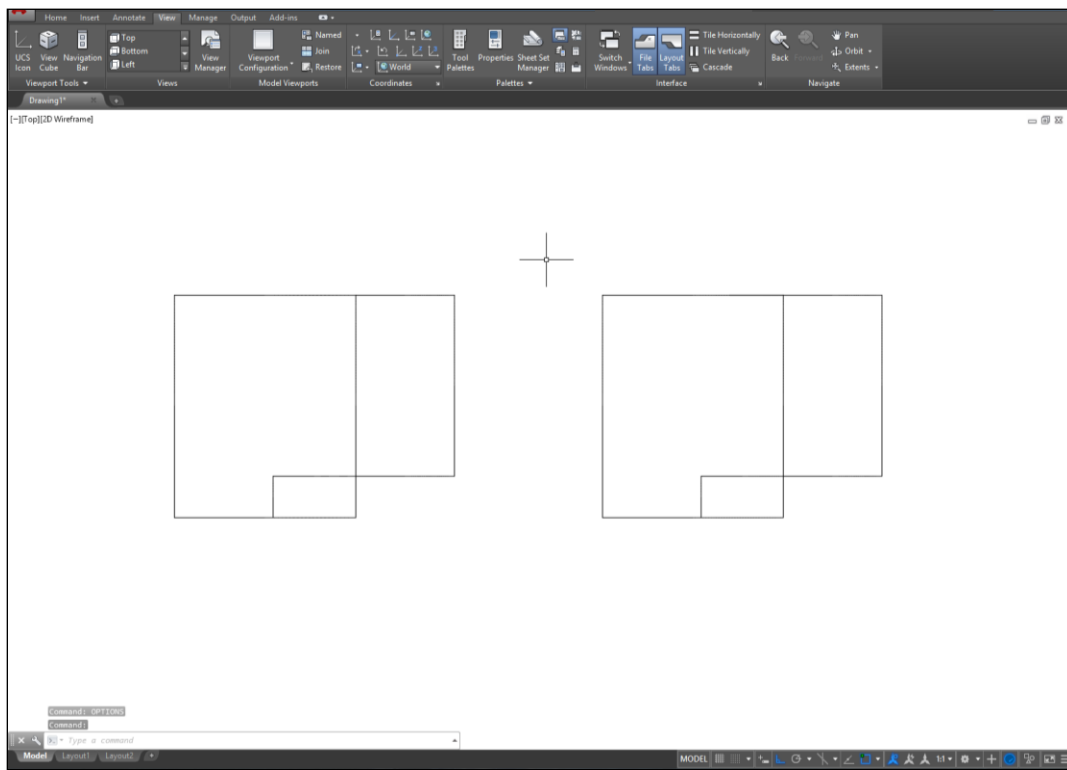

**Fig 1-9**

You can move around in the drawings by holding down the mouse wheel and **Panning** (Appendix I—Panning). Try this. Escape from all commands, place the cursor in the drawing area, hold down the mouse wheel and move

the mouse around. If you don't have a mouse with a wheel, buy one. It makes life so much easier in AutoCAD land. If you can't afford one then use the zoom features to move around (described a little later).

Let us return to our original drawing. Zoom in on the drawing to the left. Use the mouse wheel (place the cursor in the center of the drawing then turn the mouse wheel) to scroll in and enlarge it until it fills the page (see Appendix I—Zoom if you do not have a mouse wheel). Hold the mouse wheel down and pan the drawing until it is centered in the drawing space.

Let's add a new line. Click the **Offset** button. Type **6'6 <e>**. Position the cursor on the top horizontal line (**I** in Fig 1-10) and click. Move the cursor down below the line a bit and click. A new line will appear. Press the **Escape** (from now on to be abbreviated to **Esc**) button on the keyboard.

Add another line (for the stairwell—see the final floor plan if you need a reference). Click the **offset** button. Type **5' <e>**. Center the cursor box on the middle vertical line (**J** in Fig 1-10). It will illuminate. Click. Move the cursor to the left a bit and click. A new line will appear. Press **Esc** on the keyboard. Now the screen should look like Fig 1-10 (your drawing will not show the little boxes).

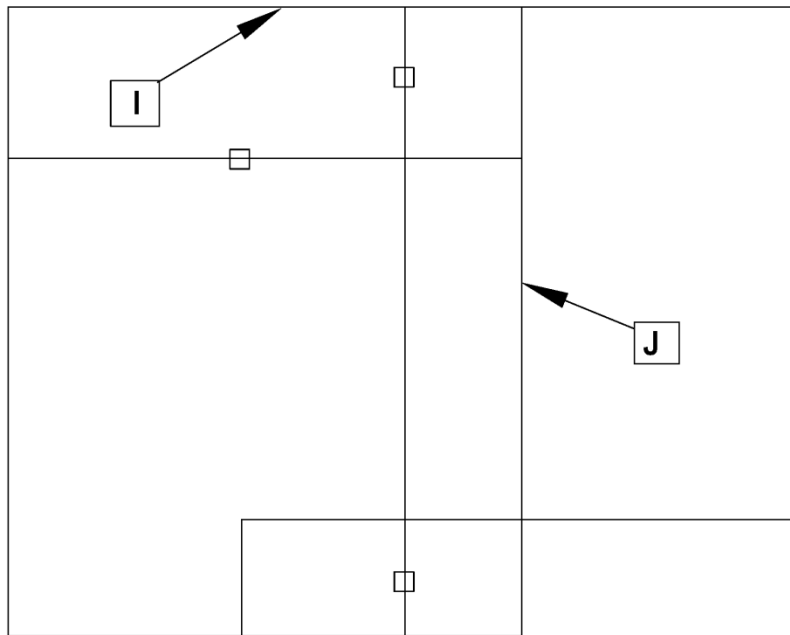

**Fig 1-10**

Now we will trim some more lines.

Click on **Trim** then immediately **<e>**. Position the cursor over one of the lines indicated by the **little boxes** as shown in Fig 1-10, click (do not enter after clicking on each of these points—just go on and click all the trim points). Click on all the points indicated by the boxes in Fig 1-10. Press the **Esc** button on the keyboard. You should now see Fig 1-11.

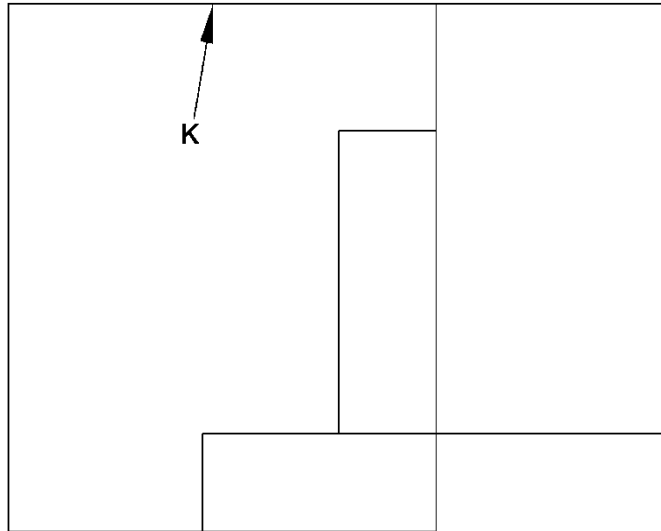

Fig 1-11

### 1.7 Walls

Figure 1-11 shows the outline of the first story floor plan. Now we will draw the wall thickness. Click the **Offset** button. **Type 3.5 <e>**. AutoCAD uses inches as the default. So if you enter feet you must designate this by using the feet sign: ('). For inches no sign is necessary. This measurement is inches.

Position the cursor on the top horizontal line (K) and click. Move the cursor down below this line and click. A new line will appear 3.5 inches below the top horizontal line. This is the thickness of that wall (nominally a 4" wall—but drawn at 3.5" because they are framed with 3.5" wide lumber).

Now let's repeat this process with all of the walls. Click Offset, position the box cursor over the far left line and click. It becomes highlighted. Move the cursor to the right of that line (any distance will do) and click. Repeat this process by drawing parallel lines on the sides of the single lines as shown in Fig 1-12. You will see that it is not necessary to hit the Offset button each time. The tool remains active until you press <e> or ESC. We are creating the thickness of the framed walls. Continue until you see Fig 1-12.

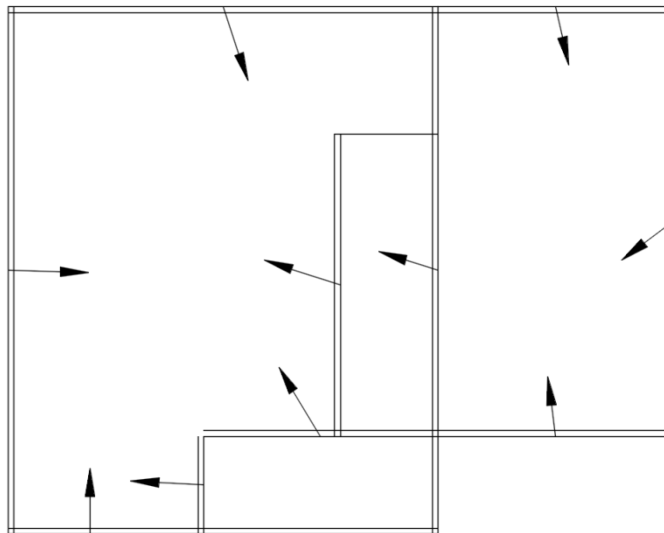

Fig 1-12

As always, do not get too caught up in the perfection of the details, if you miss something, or draw it incorrectly, you can fix it later. The main thing is to keep moving along and learn the commands and procedures. Precision and accuracy will come with practice.

Next we are going to clean up the inside corners of the walls. Click on **Trim <e>**.

Sometimes the buttons don't respond; if this happens double click them. Also you can always type any command.

Use the mouse wheel to zoom in on the upper left corner of this plan drawing. **Click** on the point indicated (approx.) by **L** in **Fig 1-13**.

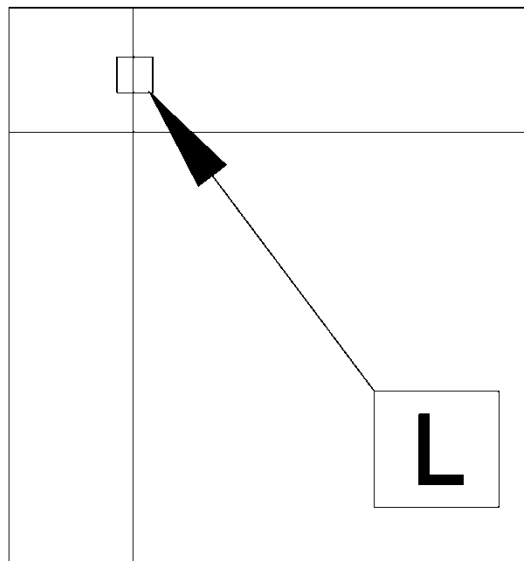

**Fig 1-13**

This will trim the line to the lower intersection of the lines as in Fig 1-16.

Use the **Trim** tool, position the cursor box over the lines in the rest of the corners, and trim the lines so that they all look like **Fig 1-16**. Remember to hit the enter key **<e>** **immediately after clicking** on the **trim button**.

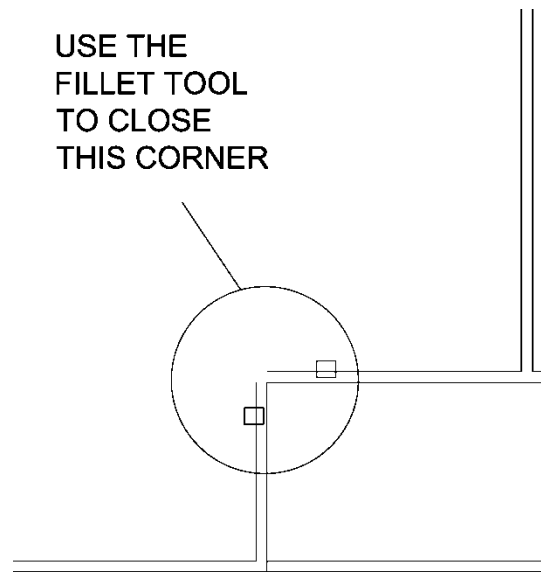

Fig 1-14

### 1.8 Fillet

To close up the open corner in Fig 1-14 use the **Fillet** tool on the modify palette.

Click the **Fillet** button on the Home ribbon. At the command line it will prompt you for options. Read the Command Line. Type: **r <e>**. This selects the radius setting.

With many of these prompts typing the first letter of the word is sufficient to choose that option. The command line will ask you to specify radius. Type **0 (zero) <e>**.

Now it will prompt you to: **select the first object or...** Type **m** (for multiple) **<e>**. The cursor will change to a selection box again. Click on each of the two lines at the boxes shown in Fig 1-14. The corner will close (square). **ESC**.

Let's make a copy of this working drawing, as we did before. Click the **Copy** button. Enclose the main drawing that you have been working on with a **green selection** window and make a copy to the right so that the screen looks like Fig 1-15. To do this click **copy**, then click the cursor to the **lower right** of the floor plan, then **draw** the **green shading** up and to the left until the entire floor plan is covered, **click again** to select the floor plan. Next **click** the cursor in the middle of the floor plan and then **click** again in the **open space to the right**. This is an approximate location (the exact location is not important). We will use this new copy for the second story floor plan and the framing plans.

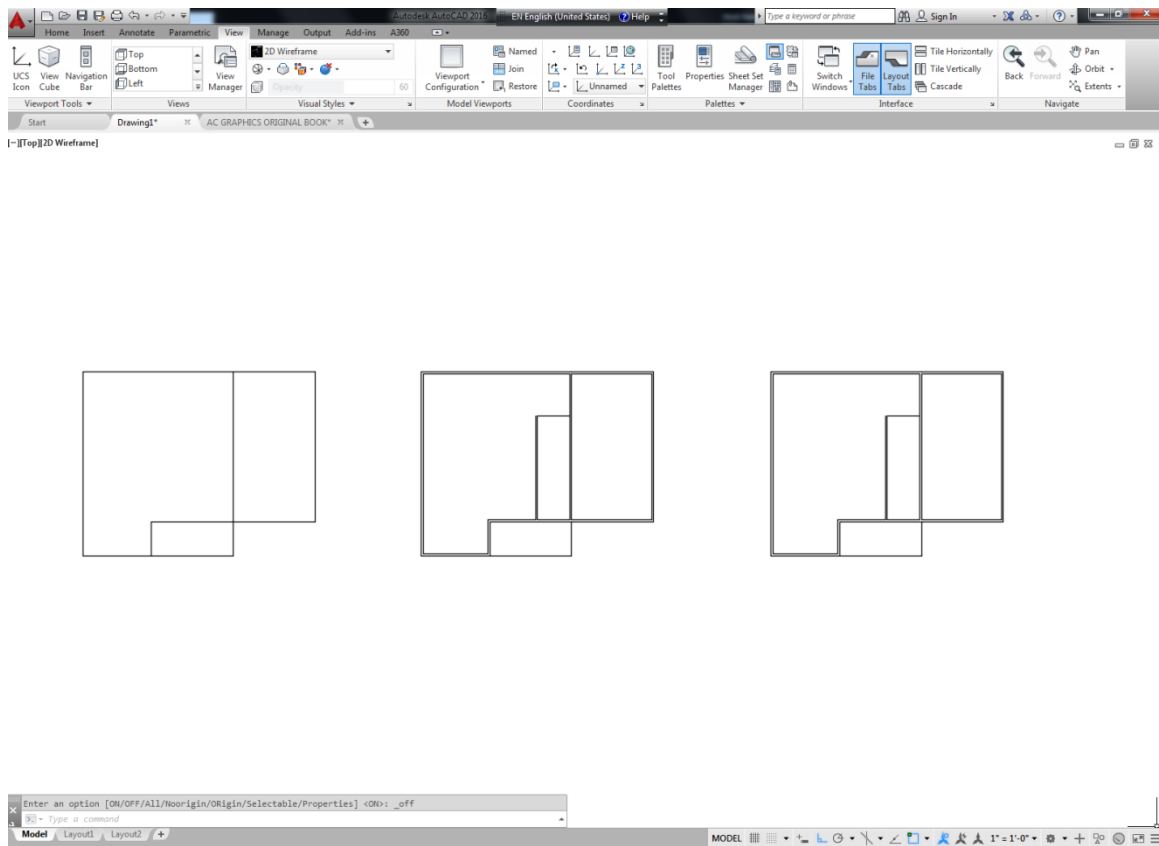

Fig 1-15

Sometimes the zoom will lock up and not zoom out enough. If this happens use the **Zoom** command `-type z<e>` then type `a <e>`. Now the mouse wheel should work.

## 1.9 Zoom

Take a minute and play around with the zoom options. Try some of the buttons on the **Navigate** panel. Click on the **View** tab. Right click anywhere on the panel and select **Show Panels**. Select the **Navigate** option. The navigate panel will appear on the ribbon. Click on the arrow in the lower right corner. Click on the **Extents** button. The entire drawing should appear.

Now click on the **Window** button in that same menu. Then click the mouse at the lower corner of one of your three drawings. Use the mouse to create a selection box around a part of the drawing by clicking on the screen and moving the cursor up diagonally and click. You can always use the ESC button and the Undo button at the top of the screen to go back if you get in trouble.

It is faster to type these commands. Type `z` for zoom and then the first letter of the type of zoom (as in `w` for window).

The Zoom Window is useful, especially when used with Zoom All. But ninety percent of the time I use the mouse wheel for zooming. See the info in Appendix I—Zoom for more on the subject of Zooming.

Your working drawing should now look like Fig 1-16 (minus the text—the text is for temporary reference).

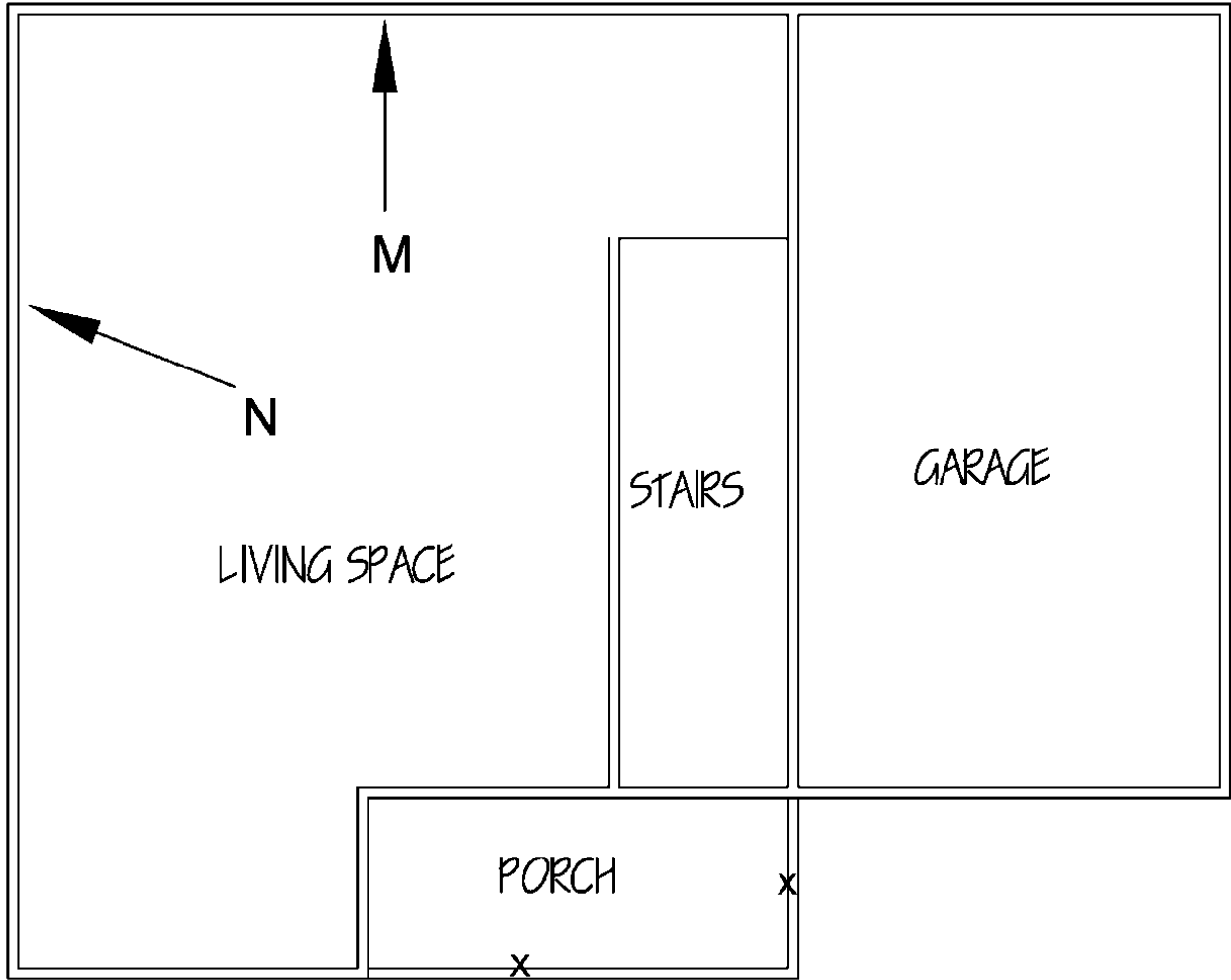

Fig 1-16

**Erase** the **lines** marked with **X's** in **Fig 1-16**. Click on them and then click the right button on the mouse. Select **Erase** from the menu that appears.

You can erase in a number of different ways. You can use the **delete** key on your computer keyboard, or click the **Erase** button in the Modify panel or enter erase at the command line. You can also select an item then right click and select the erase option.

You can select multiple objects and erase them in a group.

## **1.10 Kitchen**

Click on the **Offset** button (Home tab/Modify palette). Type **24 <e>** (this will indicate inches—the default). Click on the inside line of the wall at the top of the living space shown as **M** in **Fig 1-16**. Move the cursor down and **click inside** the living space. Repeat the process with the wall to the left of the living space (**N** in Fig 1-16). **Esc**.

Click on the Offset button again and type **8'8 <e>**. Click on the new horizontal line (**O** in Fig 1-17) and click below that line to create new line (**P**).

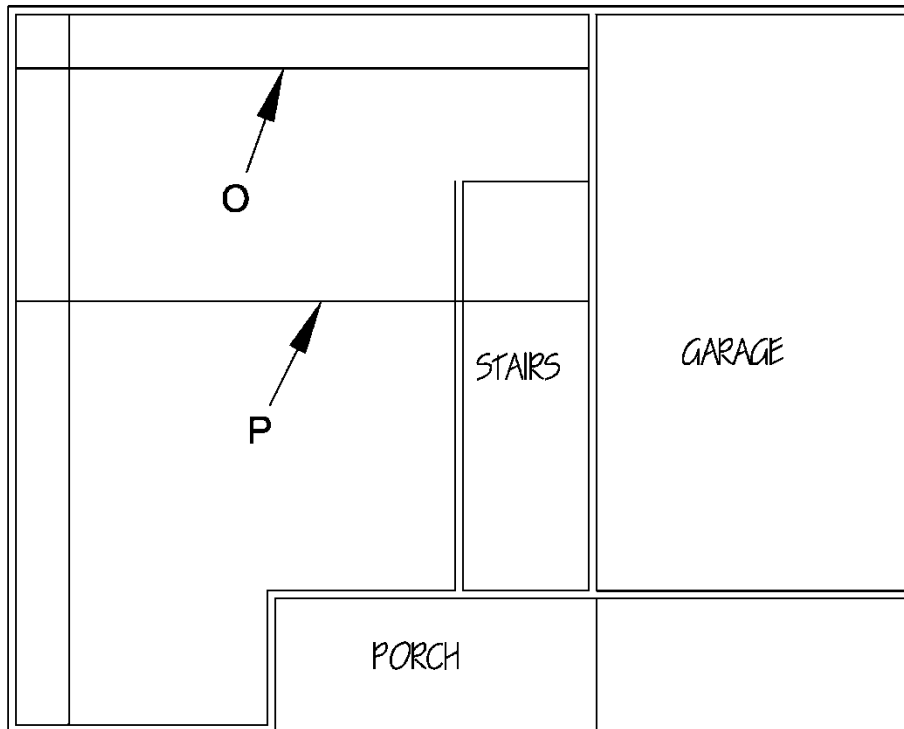

**Fig 1-17**

Click on **Trim <e>**. Trim the lines so that they look like **Fig 1-18**. If you make a mistake, use the Undo button and try again.

**Escape.**

**Click** on the line marked with an **X** in Fig 1-18 and **erase** it.



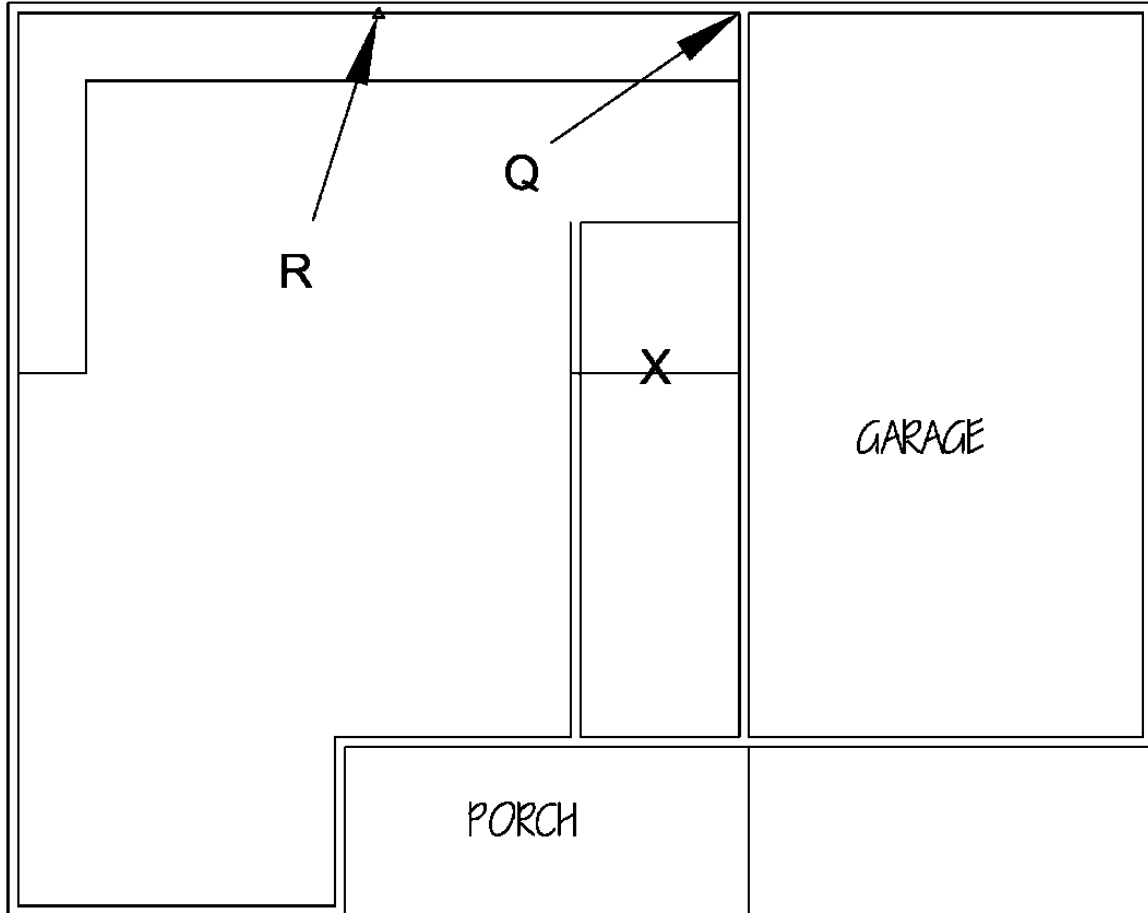

Fig 1-18

### 1.11 Offset Start Point of Line

Click on the **Line** button. Hold **down the Shift key on your keyboard and right click the mouse**. Click on the **From** selection. Now **click** on the inside corner point as marked **Q** in **Fig 1-18**. **Move** the cursor (now a cross) to the left along the horizontal line to point **R** and you will see a triangle icon (this is a snap object icon indicating the **midpoint** of this line). Do **not click on point R**, just let go of the mouse and let the cursor hover over the triangular Osnap icon. Type **7'5 <e>**. **Move the cursor down** the screen and **a line will appear** with a starting point at 7'5" from point Q. Pull the line down a ways, **do not click**. Type **3' <e>**. Hit **ESC**.

Sometimes when you make lines using the From function they do not attach correctly to the intended starting point. Zoom in and see if the line is attached to the horizontal wall. If it is not attached then undo and try again or see the Appendix I—Snap From.

Click on the **Offset** button. Type **3.5 <e>**. Click on the line that we just drew and click to the left of it to create a new short wall. At the bottom connect the ends to create the wall end as in **Fig 1-19** (use the Line button).

**Trim** the lines at the **X**'s in **Fig 1-19** (you must press enter right after you click the trim button or it will not work as a trimming tool). Escape and **erase** the line marked with an **O**. It will now look like Fig 1-20.

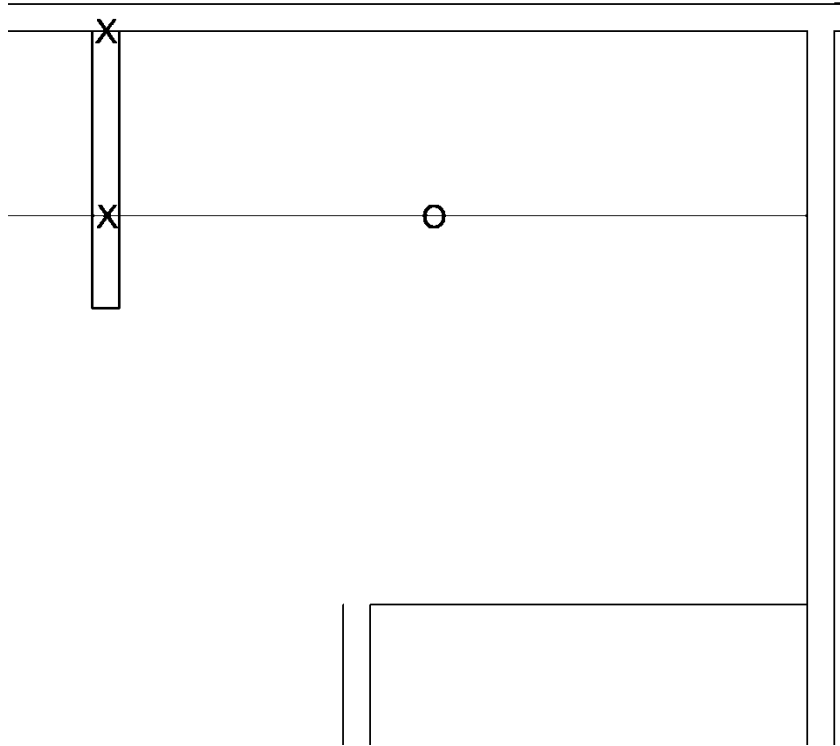

Fig 1-19

The new lines inside the living space at 24" offset represent the lower kitchen cabinets. Look at the finished floor plan in Appendix IV (or Fig 1-63) to see what we are drawing.

### **1.12 Rectangle**

Now we will create the sink and the range.

Click on the **Rectangle** button on the **Draw** palette. It is in the upper right corner and shares a button with Polygon.

Click on the empty space somewhere in the middle of the living space (see Fig 1-20). Look at the command line. It prompts for a response (Area/Dimensions/Rotation). Do not move the mouse—your typing will automatically be entered into the Command line window. **Type d <e>. Type 30 <e>. Type 24 <e>. Click** (this last click sets the rectangle in place). **Make a copy** of the **rectangle**—so we have two as in Fig 1-20. Read the prompts as you follow these instructions. The **d** selects the **Dimensions** option (this is the most common method to create a rectangle). Then the numbers you enter are the dimensions (with the horizontal dimensions first, then the vertical).

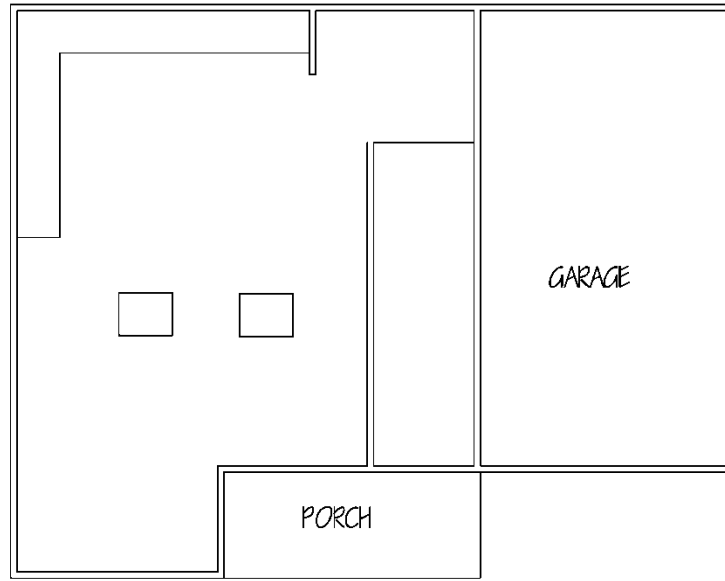

Fig 1-20

### 1.13 Rotate

Click on the **Rotate** button on the **Modify** palette. **Click on any line** of the rectangle on the left to select it and **<e>**. Read the prompts. The command line will read: **Specify base point.** **Click** (anywhere) **inside** the selected rectangle. **Type 90 <e>**. The box will now be at a 90 degree angle to its original orientation.

### 1.14 Move

Click on the **Move** button on the **Modify** palette. **Click on any line** of the box you just rotated, then **<e>**. **Click** on the **mid point object snap icon** as shown in step 1 of **Fig 1-21**. Move the rectangle around a bit. You will see that it will only move at right angles. We want to release the box to move free from this right angle constraint, so we will turn off the **Ortho**. Press the **F8** key. This will turn off the **Ortho** function (and the Ortho button at the bottom of your screen will un-highlight or pop out).

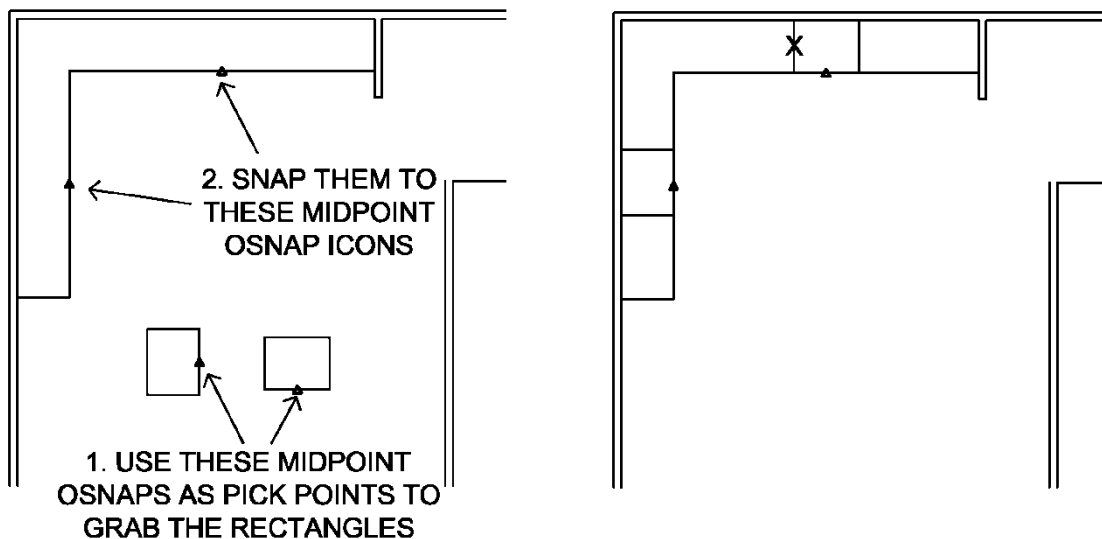

Fig 1-21

**Move** the rectangle and **snap it** to the kitchen counter at the center of the vertical section of the kitchen counter (the triangle to the right shown as step 2 in Fig 1-21) snap to the object snap **triangle icon** at the midpoint of the line shown. When you approach the midpoint of a line (with the midpoint osnap turned on) a small green triangle will appear. Click on this and the rectangle will copy to this point. It will “**snap to**” this point.

Now click on the **Move** button again and **select** the other **rectangle** (not rotated). **Grab** it by the middle of the lower line by clicking on the **triangle icon** (midpoint icon as shown in step 1). **Move** it up and place it on the center of the horizontal cabinet line at the midpoint icon for that line. Your kitchen cabinets will look like the right half of Figure 1-21 (minus the triangles).

Click on **Offset**. Type **3 <e>**. Click on the left vertical line marked X in the right drawing of Fig 1-21. Click in the center of the rectangle. **Esc**. This will create a parallel set of lines inside the rectangle as in Fig 1-22.

Click on the **Fillet** button on the **Modify** palette. Type **r <e>**. Type **2 <e>**. Then **m <e>**. Read the Command Line as you type, you will see that you are choosing the **first letter** of the various options offered. Click on the corners of the inside rectangle that you just created as shown in Fig 1-22 to create a radius corner at each corner.

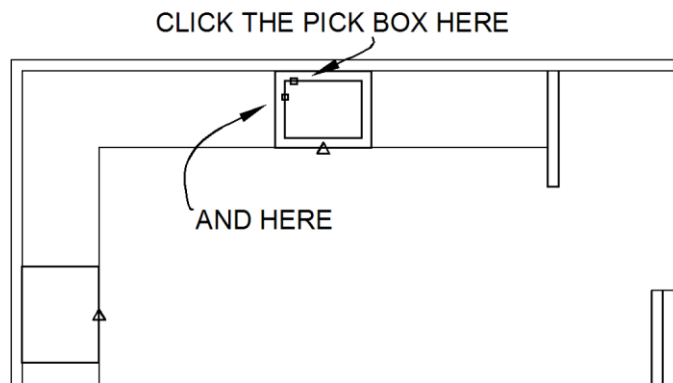

**Fig 1-22**

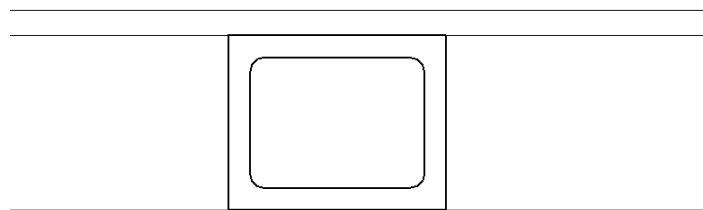

**Fig 1-23**

Click on the other corners of the rectangle; continue until the rectangle looks like Fig 1-23. This is the sink.

Now let's make the other rectangle into a stove. Let's find the center of the rectangle by drawing two lines that start and end at the midpoints as in Fig 1-24.

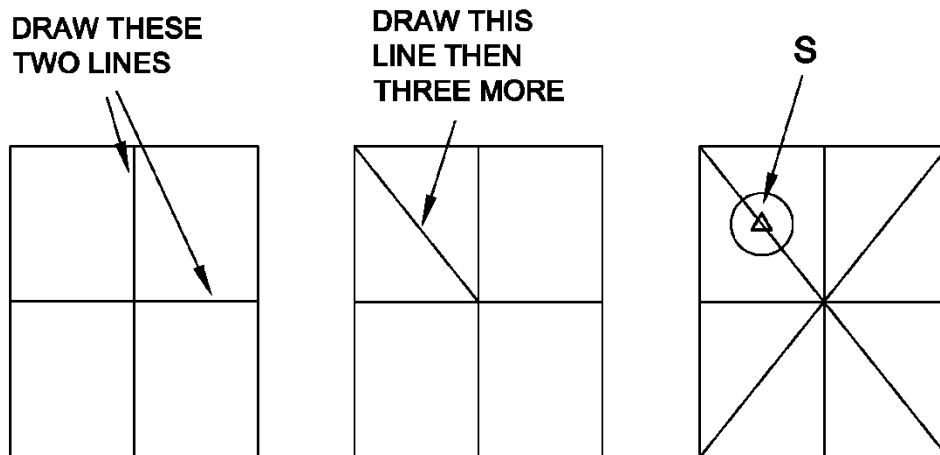

Fig 1-24

Now draw **four separate diagonal lines** as shown to the right in Fig. 1-22. (*They must be four separate lines to make this work, so don't cheat by drawing this with just two lines*). We will use these diagonal lines to find the center of each quarter of the rectangle by snapping to the center of each diagonal line.

Click on the **Circle** button on the **Draw** palette. Click on the **midpoint osnap icon** at **S** in **Fig 1-24**. Type **d <e>**. Type **6 <e>**. **ESC**.

Click on the **Copy** button and then **click** on the **edge** of your new **circle** and **<e>**. Grab the circle at the **center** by clicking on the **triangle** icon. Now copy the **circle** to the **center** of the other **three diagonal lines**. **ESC**.

Now **erase** the **diagonal lines** and the lines that cross the center of the rectangle. Your drawing will look like Fig 1-25.

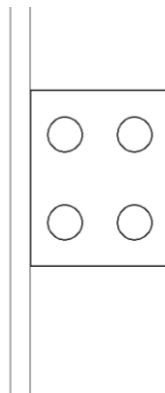

Fig. 1-25

### 1.15 Chimney

Now we are going to create the chimney and fireplace. Click on **Offset**. Type **8' <e>**. (Don't forget the ' symbol—you will get inches by default—you want feet.) **Click** on the lowest horizontal line at **T** in **Fig 1-26**. Move the mouse **up** and **click**. Right click the mouse and select **Enter** from the short cut menu box. This is a quick way of doing Enter. If no short cut box appears or one that doesn't include an **Enter** option then you can just press **<e>** on your keyboard (and see Appendix I—Mouse settings).

Click **Offset**. Type **12'** <e>. Click on the lowest horizontal line (**T** in **Fig 1-26**) again and then click again **up above** it and <e>.

Click **Offset** again. Type **18** <e>. Click on the vertical line to the left (**U** in **Fig 1-26**) and then to the **left** of that line and <e>.

There is another way to do repeated tasks, like three offsets in a row. Instead of the final enter in the above steps right click the mouse and a shortcut menu will give you some options, the top option will be **Repeat** the last command, click on it. You can also use this to access a list of other commands. Check it out.

Using this flyout menu can speed up your drawing.

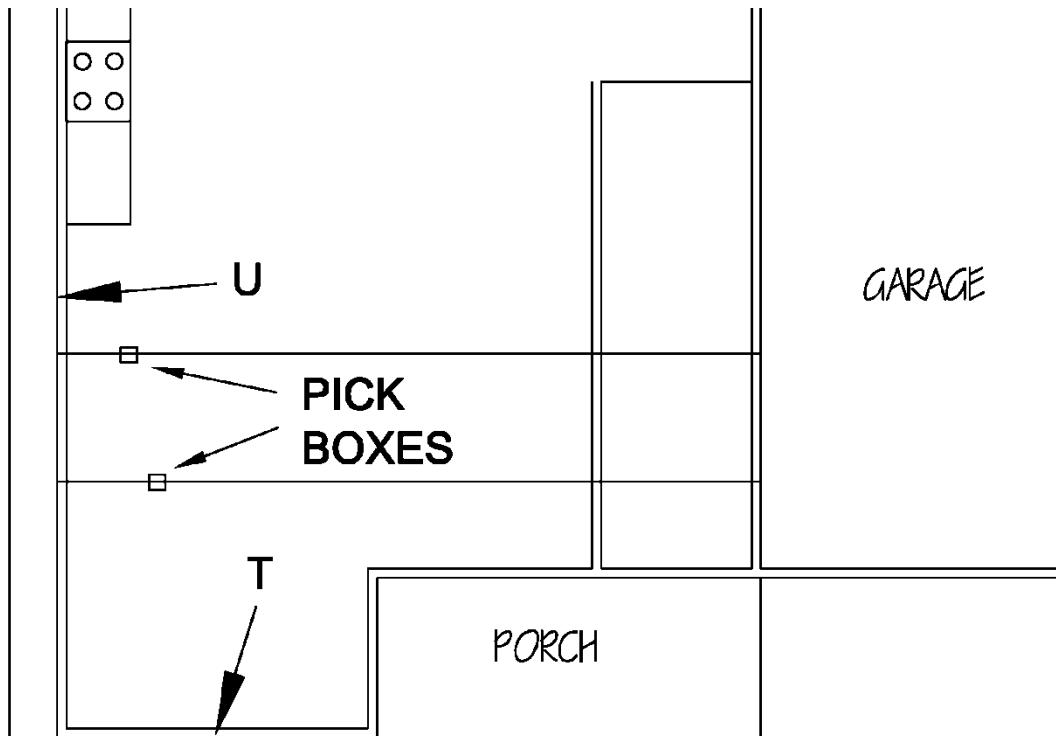

**Fig 1-26**

Your drawing should now look like Fig 1-26 (minus the references, pick boxes, and leaders).

### **1.16 Extend**

Click on the **Extend** (co-located with trim) button on the **Modify** palette then <e> (you can right click the mouse to **enter**—with this function—if your mouse is set up this way. See Appendix I—Mouse settings). Click on the **lines** shown in **Fig 1-26** by the pick boxes. **ESC**. The lines should extend over to meet the new vertical line at 18' beyond the wall line as in Fig 1-27.

Extend is one of the more persnickety of the commands and sometimes it does not work the first time. If it doesn't work try clicking closer to the end of the line and, if that doesn't work, try again by escaping and re-clicking the Extend button then immediately press the enter key. See Appendix I—Extend for help.

Now your drawing should look like Fig 1-27.

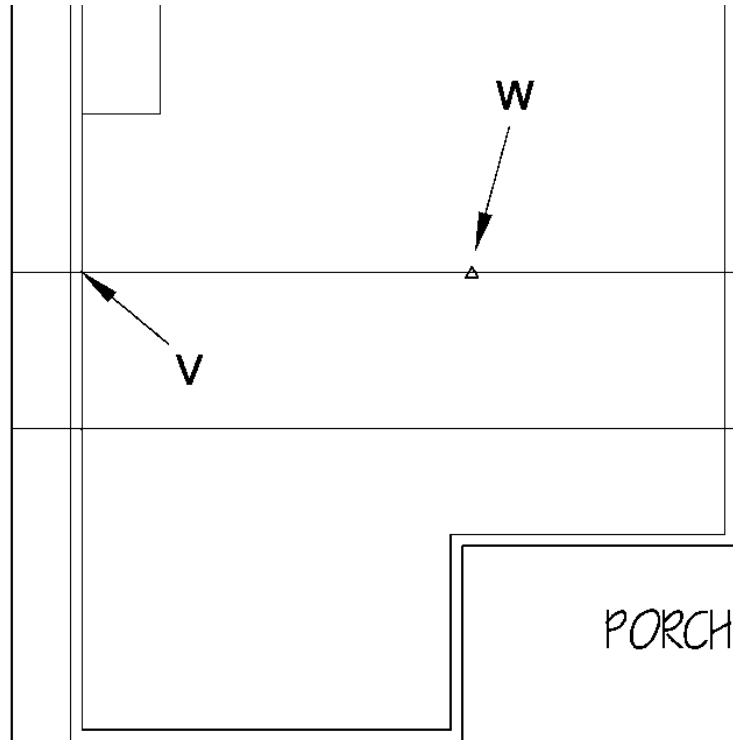

Fig 1-27

Click on **Line**. Hold down the Shift key on your keyboard and right click the mouse to bring up the Osnap menu. Select **From**. Now **click** on the intersection at **V** in Fig 1-27. **Move** the **cursor** to the **right along line W** in Fig 1-27 until you **hover (don't click)** over the **midpoint** Osnap icon (triangle). Type **8.5 <e>**.

Turn the **Ortho on (F8)**. Move the **cursor down** and to the **left** until a **vertical line appears**. You should have a stretchy line that **starts** at 8.5 inches to the right of point V. Pull the line down until you intersect with the line below. A **perpendicular osnap icon** should appear. **Click** on it. Then **ESC**. Now it will look like Fig 1-28 (minus the text and boxes).

Sometimes the line created with the From command doesn't attach to the perpendicular line at the starting point. Then when you try to trim (as you will in the next step) it doesn't trim. If this happens erase the new line and try again or use the Extend command to attach it.

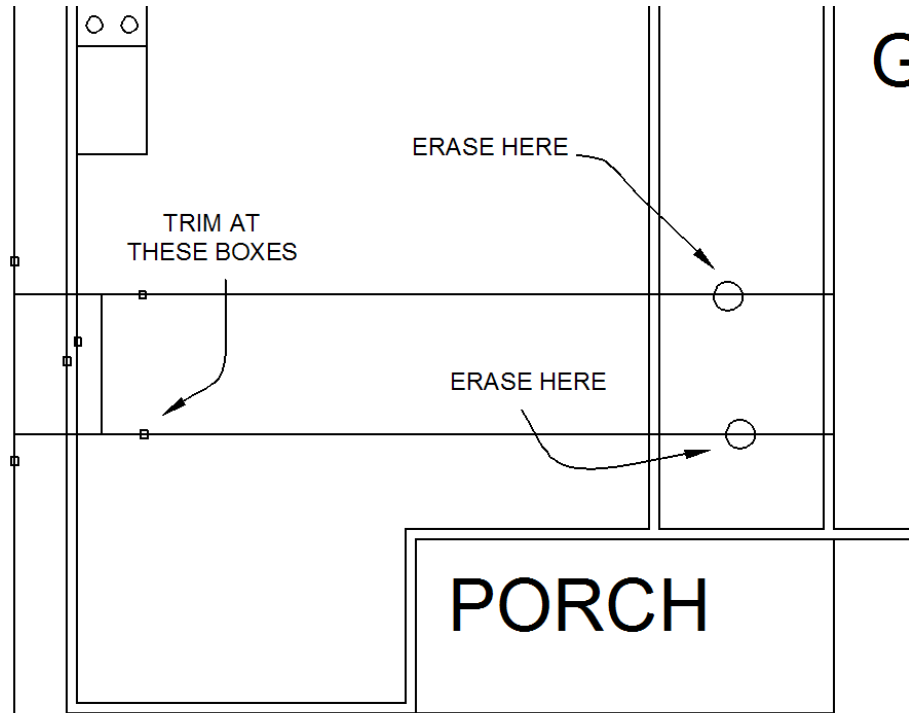

Fig 1-28

Click on **Trim** <e> and trim the **lines** at all the little boxes as shown in **Fig 1-28**. After you trim, **erase** what is left of the lines as shown in **Fig 1-28**. You will see Fig 1-29.



Fig 1-29

Click **Offset**. Type **5** <e>. Click on the **top horizontal line** of this rectangle. Click below that line and <e>.

Right click and a menu will appear. Click on **Repeat Offset** (or use the old method and just click Offset). Type **14** <e>. Click on the **top horizontal line** of the rectangle again. Click below. **Esc**. You will now see the two offset lines shown in Fig 1-30 (minus the diagonal line).



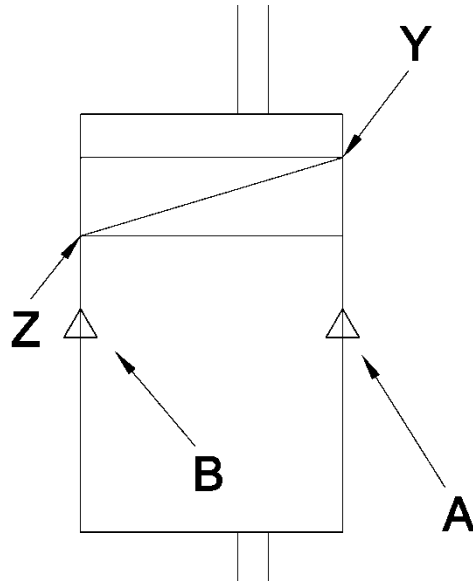

Fig 1-30

Turn the **Ortho off**. Draw a **line** from **Y** to **Z** in **Fig 1-30**. **Esc**.

Click on the **Mirror** button on the **Modify** palette. The Command Line reads: **Select Objects**. Click on the new diagonal **line YZ**. Then **<e>**. The Command Line reads: **Specify first point of mirror line**. Click on the middle of the right side of the rectangle on the **midpoint icon** that will appear when your cursor approaches the point shown as **A** in **Fig 1-30**. Move the cursor to the left and **click** on the middle of the other side of the rectangle (**point B**). Then **<e>**. You will see Fig 1-31.

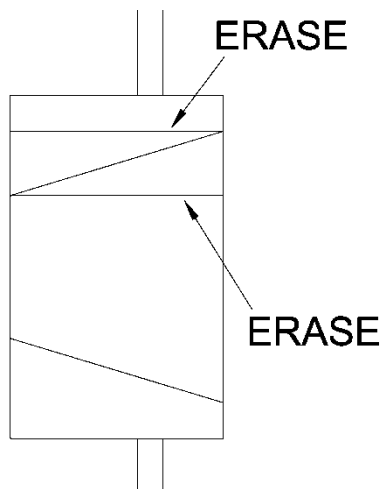

Fig 1-31

**Erase** the **lines** as shown in **Fig 1-31**. Click **Offset**. Type **3.5 <e>**. **Click** on the **sides** of this **rectangle** and create walls inside the rectangle to look like **Fig 1-32** (minus the boxes).

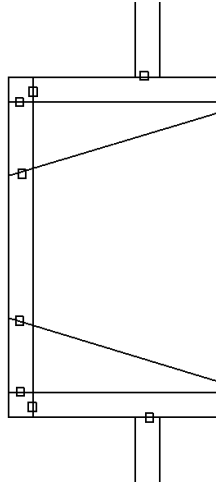

Fig 1-32

**Trim** the lines at the points marked with the **boxes** shown in **Fig 1-32**. The fireplace will now look like it does in Fig 1-34.

### 1.17 Door Openings

Now we will create the door openings. Click **Line** then hold down the shift key and right click the mouse. **Select From in the menu that opens. Click** on the upper left corner as marked **C** in **Fig 1-33**. Move the cursor down that same line to where it shows an **endpoint** icon at the chimney (point **D**). Hover over this icon, **do not click**. Type **11'6 <e>**. Turn the **Ortho on**. Draw a line to the right and connect to the **perpendicular** point icon on the other side of the wall at **E** in **Fig 1-33**. **Esc**. Zoom in. Click **Offset**. Type **32 <e>**. Click on the line you just drew and **click below** to draw the line at **F** in **Fig 1-33**.

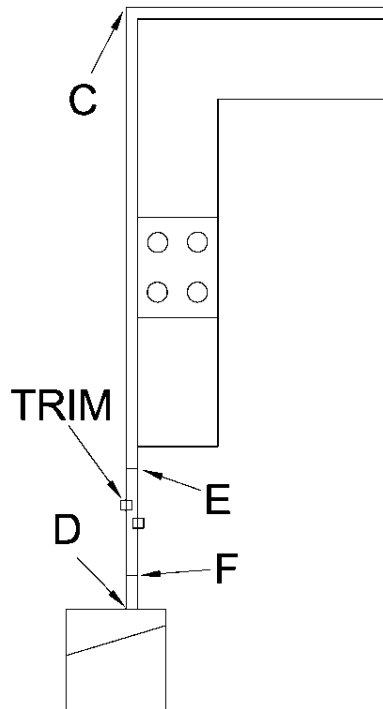
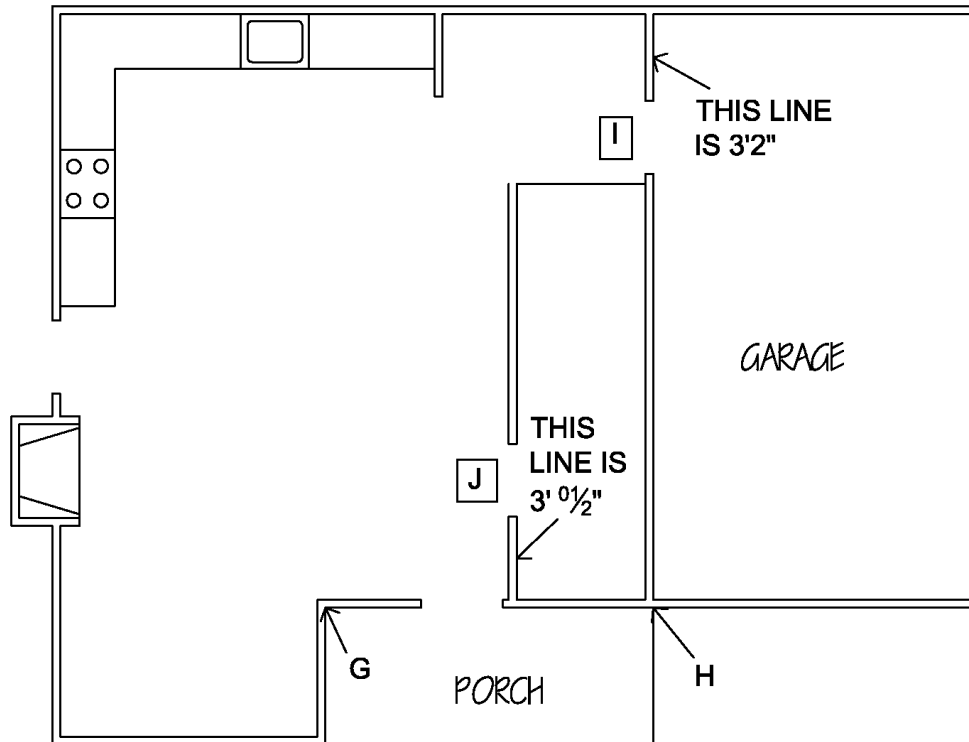

Fig 1-33

**Trim** the lines at the boxes shown in **Fig 1-33**. This is a door opening. Now we will **repeat** the process to create the door openings as shown here in **Fig 1-34**.



**Fig 1-34**

To create the lower door opening use **Line** then **From** (Shift + right click) and click on point **G** in **Fig 1-34** then **hover** over the osnap icon that appears when you approximate point **H** (do not click here—just hover). Type **6'6 <e>**. Attach the line to the other side of the wall as shown. Use the **Offset** tool to draw the other side of the door opening at **36 inches** offset, then trim the opening. This is the front door to the house.

Use the **Line** and the **From** buttons for the first line of all the openings. Use the **measurements** shown in **Fig 1-34** to draw the first line of each door opening. The dimensions shown are the offset for the first point of the door opening lines. They indicate the length of the lines shown after you trim for the opening.

The dimension that reads  $3' - 0 \frac{1}{2}''$  is typed  $3'0.5 <enter>$  (also 36.5 or  $3' 0 \frac{1}{2}$  works). Draw the first line, then use the **Offset** button to create the line at the other side of each door opening. The **door opening** sizes are all **32''** except the lower (**front**) **door** which is **36''**. Use the **trim** to remove the **lines** inside the door openings.

Now let's add the doors. Turn the **Ortho off**. Click **Line**. Click at point **K** in **Fig 1-35**. **Type: @32<315 <e>**. **ESC**. This is a new way to draw a line. The **32** is the **length** of the line and **315** is the **angle**. This is the easiest way to draw lines that are a specific length and at a specific (non right) angle. (See Appendix I—Polar Coordinates for an explanation).

Let's create the door swing arc. Click on **Circle** on the **Draw** palette. **Click** on **K** then **L** in **Fig 1-35**. You will see **Fig 1-35**. Make sure you click on the intersections and not the midpoints.

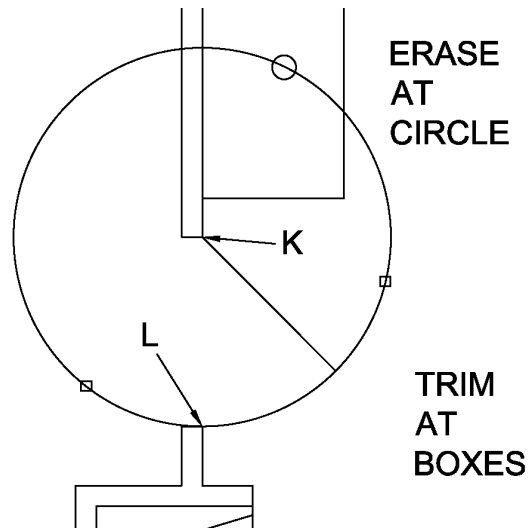

Fig 1-35

**Trim** the circle at the **boxes** and **erase** the remaining line at the **circle**. Now repeat this process for the other doors.

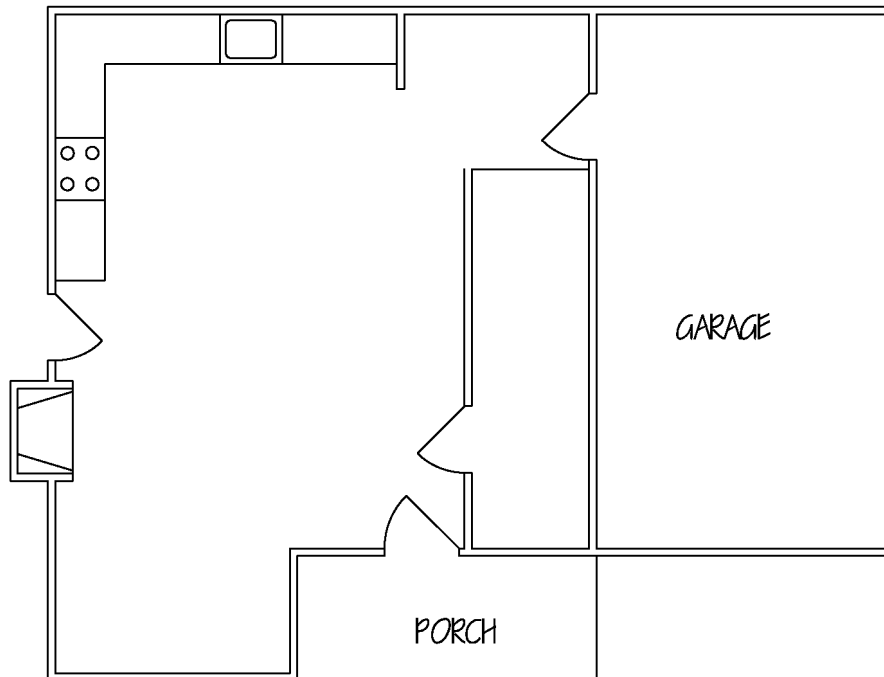

Fig 1-36

Remember the front door is 36". The measurements and angles that you need are: @32<225 then <e> at the upper garage door **I** in Fig 1-34, @32<225 then <e> for door **J** in Fig 1-34, and @36<135 then <e> for the **front door**. Create the **arcs** for each door following the steps as before. You will see Fig 1-36.

When you input measurements you can always enter them as inches (you don't need to use feet). So the Offset from measurements that we used here for the first line of the bath door opening could be **36.5** or **3'0 ½** or **3'0.5**. **Remember inches do not need to be identified** because inches is the **default unit** of measure—no entry for units means inches.

## 1.18 Windows

Now we will draw the windows. First we will create a new layer. **Layers** in AutoCAD (as in a number of different graphic programs) are essentially a series of transparencies overlaying each other. They can be turned on and off for a variety of purposes, some of which we will explore as we go along.

To create a new layer find the **Layer Properties** button (see **Fig 1-37**). **Click it**. It may take a moment to respond. A **dialog** box will open that looks like **Fig 1-37**. You can expand this window by grabbing the side border when a double arrow line appears, hold down the left mouse button and pull. Also the border at the bottom down.

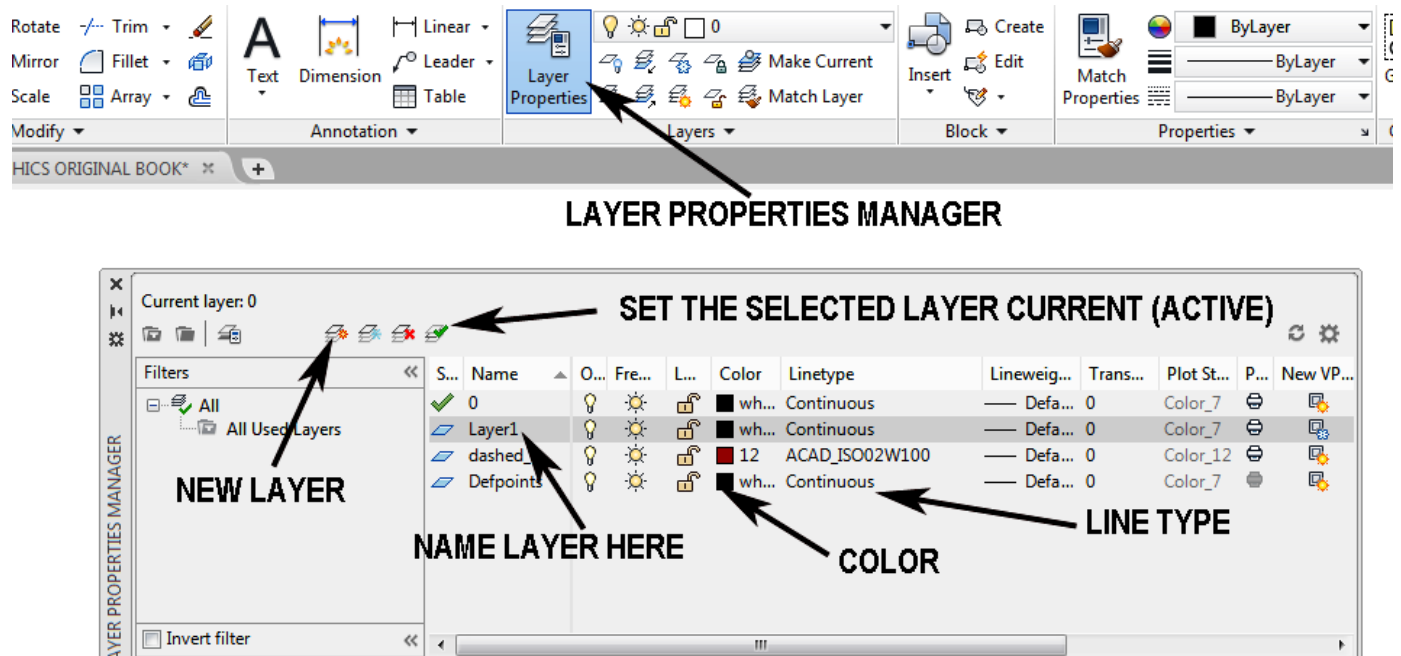

Fig 1-37

Click on the **New Layer** button as shown in **Fig 1-37**. A new line will appear. In the **Layer Name** window type: **windows <e>** to give it a name. Click on the **Line Color** where it says **white** or **w....** A **Select Color** box will open. Click on the **Index Color** tab at the top and select a **red box**. Click the **Okay** button at the bottom. Close the Layer Properties Manager by clicking on the x in the upper left corner.

Back in the AutoCAD main screen click on the **Layer Control** window as shown in **Fig 1-38**.

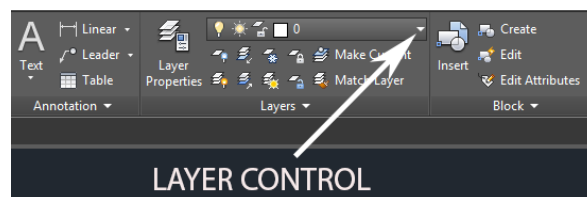
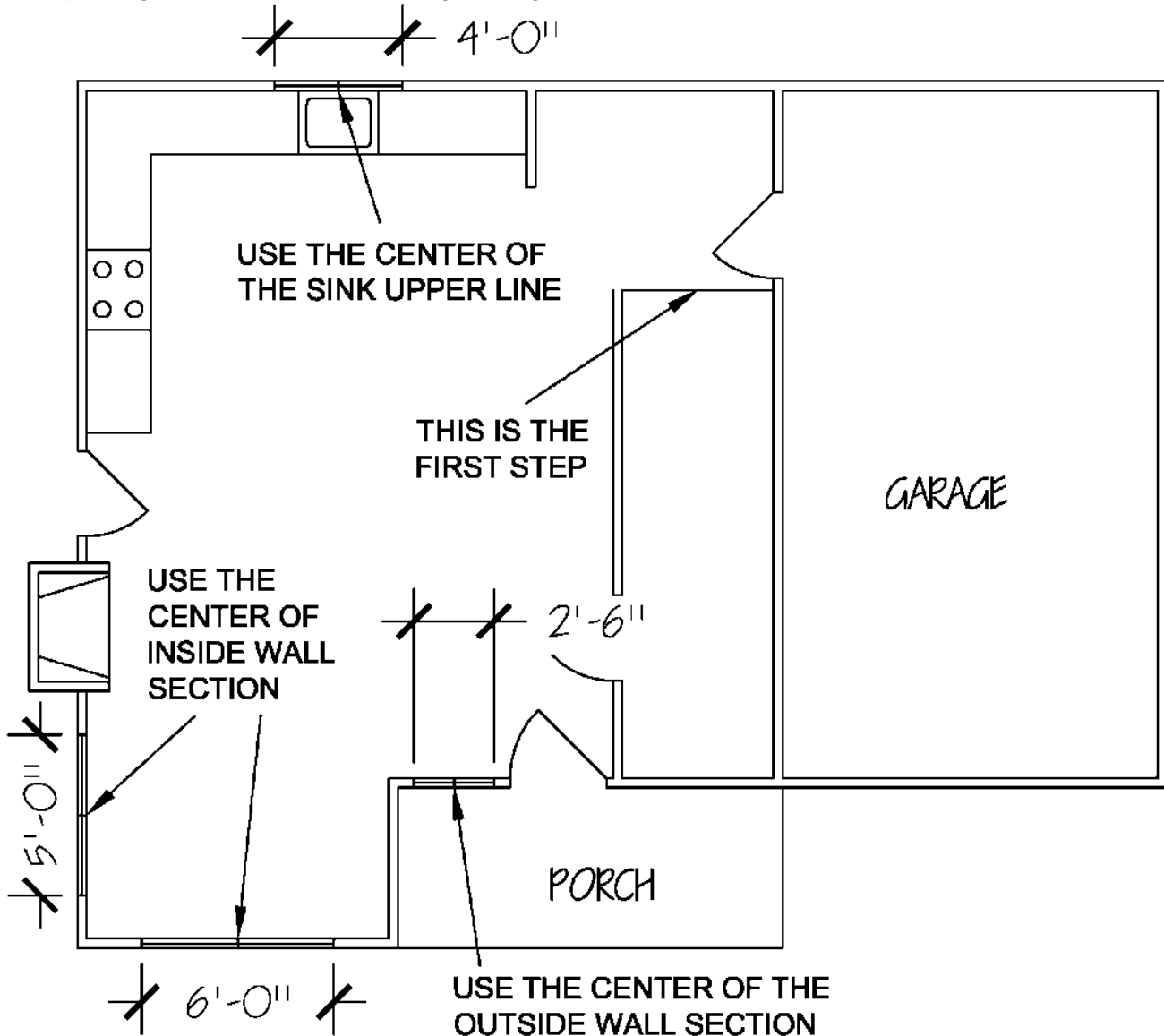

Fig 1-38

A drop down box will appear. **Click** on the **Window** line. Now the layers box will show the **Windows layer**. It will be set as the **current layer** (to use the correct jargon).

**Fig 1-39** contains all of the information that you need to draw the windows. In each case, start with the center line as indicated. They are all located on the **midpoint** of a line; except the window over the sink, it is located on the **midpoint** of the **sink rectangle** upper line. Locate the **midpoint osnap** icons at the points indicated. Start the line at the midpoint icon then attach the other end of the line to the opposite side of the wall (at the **perpendicular osnap** icon).

Use the **Offset** to draw the lines **parallel** to the **center line** to create the ends of the windows (over the sink that will be 24 inches each way from the center, the 5'0" window will be 2.5' each way from center, the 2'6" window will be 1'3" each side of center, the 6'0" window will be 3' each side of center). Then use the **Line** tool and snap to **midpoint** again to create the line running the length of each window.



**Fig 1-39**

Now let's create the stairs. Click **Offset**. Type **10 <e>**. Click on the **FIRST STEP** line shown in **Fig 1-39**. Then type **m <e>** at the prompt. **Click** below that line and then below the new line and **repeat** until you have **11 lines**. This set of stairs will have 14 steps but we will only show 11 lines (including the first line) on this first story floor plan view because a portion of the bathroom is located below the stairs).

## 1.19 Design Center

We will now draw the bathroom fixtures. Start by creating a **new layer**. Go to the **Layer Properties Manager** again. **Create a new layer**. Name it **Fixtures** and leave the color white. **Close** the dialog box. In the **Layer Control** drop down box click the little arrow and select the **Fixtures** line. This will make the Fixtures layer the **current layer**. It will say: Fixtures in the Layer Control window.



Now on the **Palettes** palette on the View ribbon there is a button titled **Design Center**; it looks like this: . Click on it and the **Design Center dialog box** will open. You can also type: adcenter.

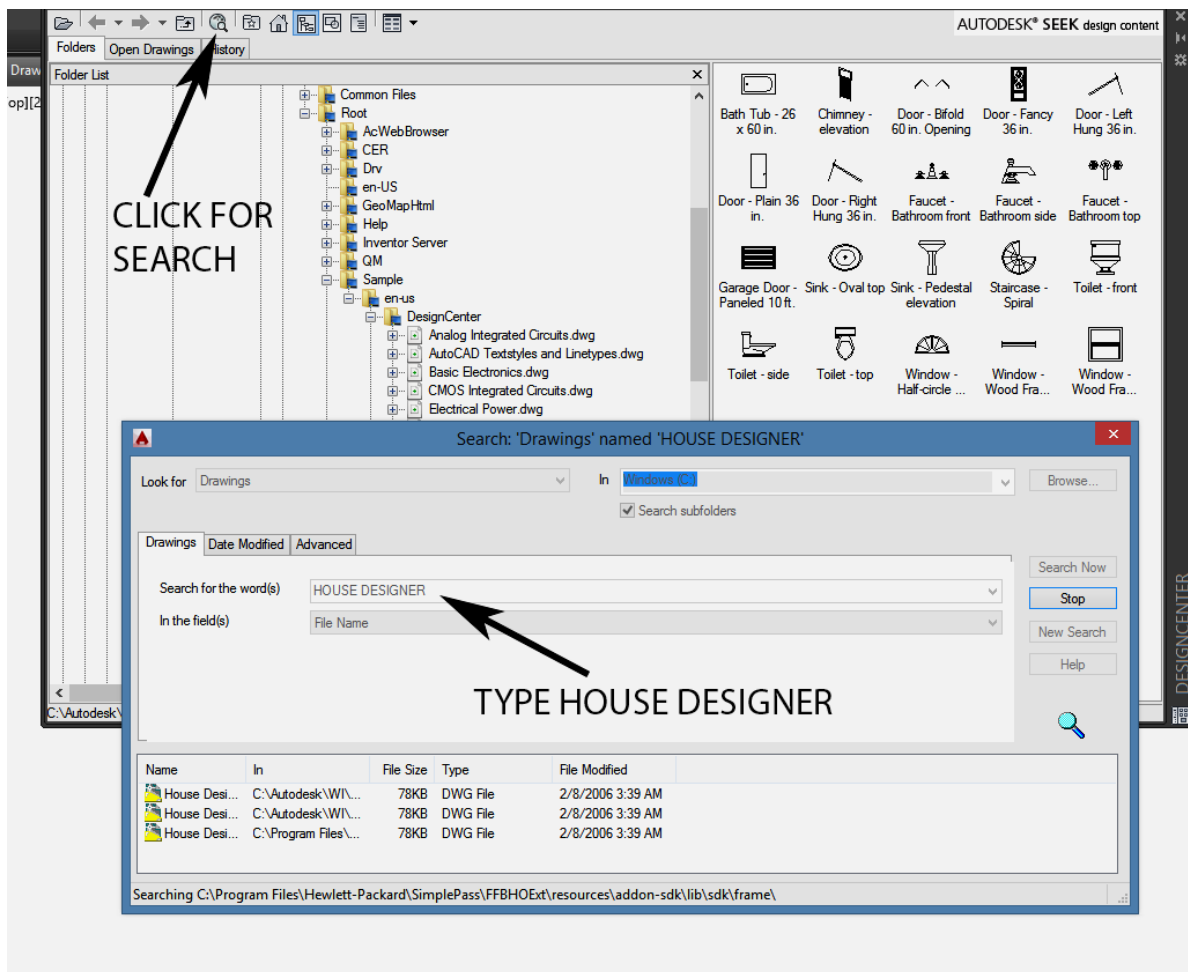

Fig 1-40

Click on the **Search** button as indicated in **Fig 1-40**. In the search window type: **house designer**. And Select the first search result below.

When the House Designer folder opens double click on the Blocks icon as in Fig 1-41.

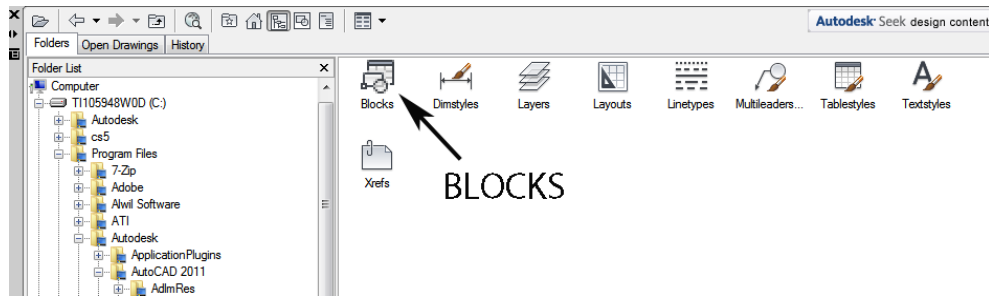

Fig 1-41

**Center the cursor** over the **toilet symbol**, hold the left mouse button down, pull it over and release the button on the AutoCAD drawing screen (not too close to the house) as shown in **Fig 1-42**. (This is called **drop and drag**.)

Do the same with the **Sink** symbol and the **Bathtub** symbols as indicated in **Fig 42**. **Close** the Design center box (click the x at the upper left corner).

An alternate method is to highlight the symbol (ex: toilet) right click, select the **Insert Block**, click on **Okay** in the **Insert dialog box** that pops up, then place the cursor on the drawing screen and click.

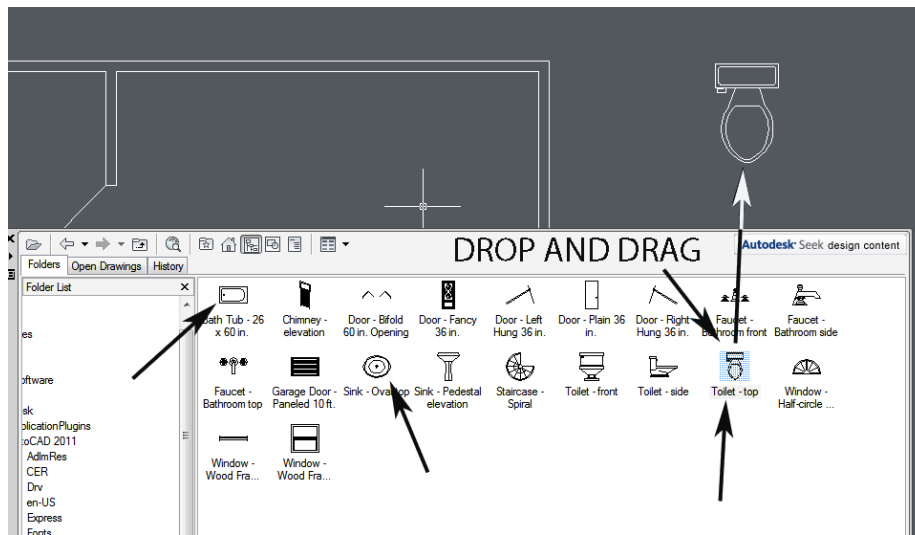

Fig 1-42

Now we will place the toilet and sink. Rotate the toilet. Click on the **Rotate** button on the Modify palette. **Click** on the **toilet <e>**. (Sometimes when you click on an object it will show little blue boxes and triangles, *you do not want this*, so escape and try again until the toilet appears as a highlighted line drawing as in Fig 1-44.) The prompt will read: **Specify base point**. This is the point you will rotate around. **Anywhere on the toilet** symbol is fine. **Click** and the prompt will read: **Specify rotation angle**. **Type 180 <e>**. Now rotate the sink—enter **90 <e>** for the angle of rotation for the sink.



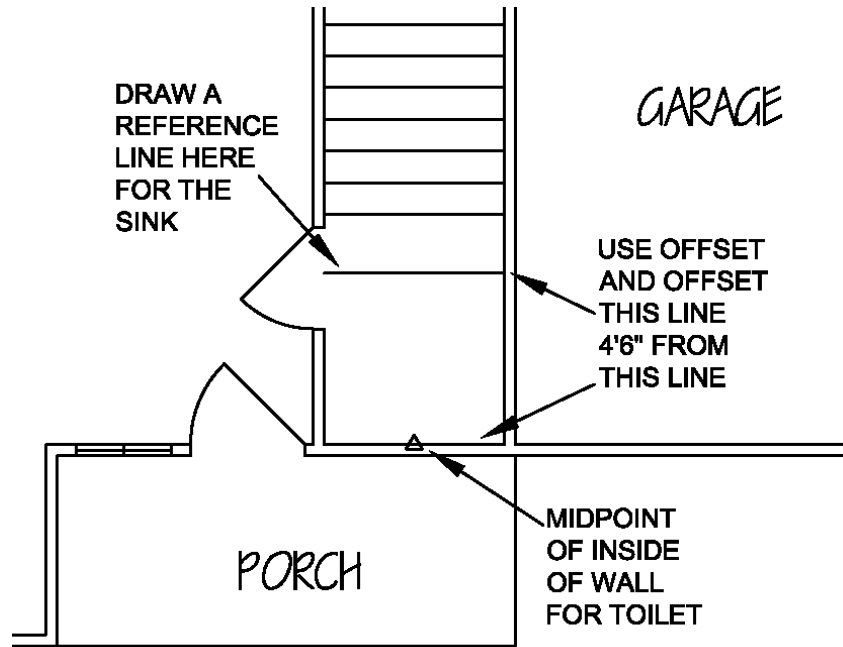

Fig 1-43

Move the toilet. Click on the **Move** button on the Modify palette. **Click** on the **toilet <e>**. The command line will prompt for: **Specify base point**. This is where you will grab the toilet. Grab it at the **midpoint** of the back of the toilet as in **Fig 1-44**. Make certain that the **Ortho** is turned **off**. Drag the toilet and place it as shown in **Fig 1-45**. This is the midpoint of the inside wall section indicated in Fig 1-43.

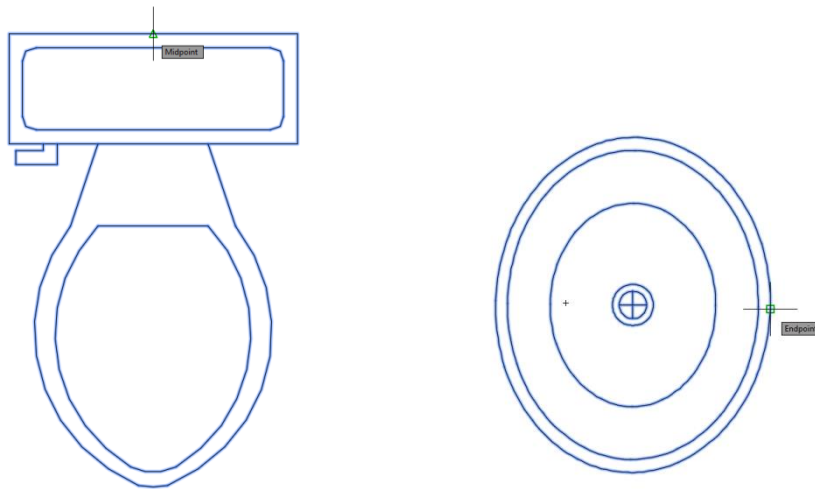
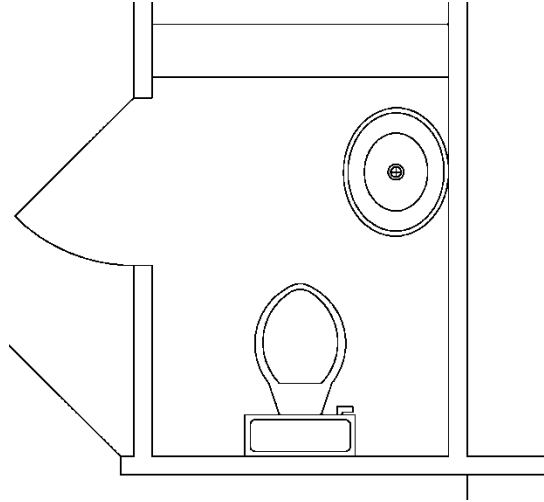

Fig 1-44

Create the **line** shown in **Fig 1-43** as a reference point for placing the sink. It is **offset 4'6"** (use the **Offset tool**) from the inside of the bathroom wall (see Fig 1-43). This a temporary line to mark a point on the bathroom wall—the point on the wall where we will snap the copy of the sink.

Now **move** the **sink**. Place the sink as shown in **Fig 1-45**. Snap the sink to the intersection of the wall and the reference line that you created. When you go to grab the sink you may notice that the icon you want is a box (endpoint as shown in Fig 1-44) and not a triangle (midpoint). This is because the sink is made up of series of arcs and lines. Erase the reference line when you have placed the sink.



**Fig 1-45**

You can move the toilet and sink away from the walls with the Move button. Click **Move** then **select the toilet** <e>. Turn the **Ortho on**. Click on the **toilet again** anywhere. **Move** the toilet **away from the wall** a bit and **type 1** <e>. It will move it 1 inch away from the wall. Repeat for the sink.

### **1.20 Washer and Dryer**

Now draw the washer, dryer and water heater and then our graphics will be nearly complete for the first floor.

Set the **0 Layer current**.

Create a square anywhere in open space that is **30"** x **30"**. Click on the **Rectangle** button then **click** in open space. Follow the prompts at the command line (**d** <e> for dimensions at the prompt, then **type** the dimensions **30** <e> and **30** <e>, then **click** on the screen to set the rectangle. If you have forgotten how to do this, review section 1.12.

Now **copy** the **square** to the places shown in **Fig 1-46** by **snapping** the **corner** of the box to the **inside corners** of the **walls**. Turn the **Ortho off** and the **Object Snap on** (F3). You will need to do two different copies: one for the right hand corner and another for the left hand corners. Click the **Copy** tool, then on the rectangle, then grab it by the corner osnap icon, snap this to the inside corner icon where you wish to copy.

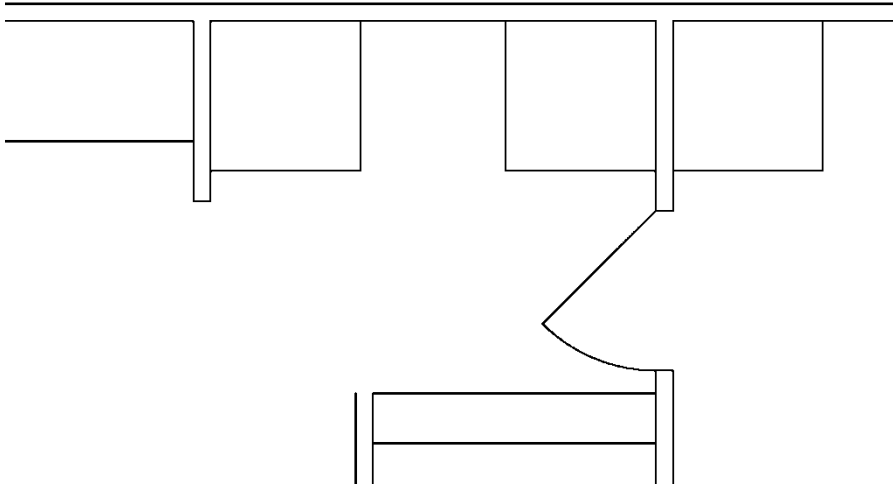

Fig 1-46

Now move the boxes representing the washer and dryer away from the walls one inch by using the **Move** button as we did with the toilet. Turn **Ortho on**. At the prompt for: **Specify base point**, show which way you want to move the rectangle by clicking on the rectangle, holding down the mouse button, moving it a bit in the direction you want it to move, and type **1 <e>**. Repeat in the other direction until it looks like Fig 1-47.

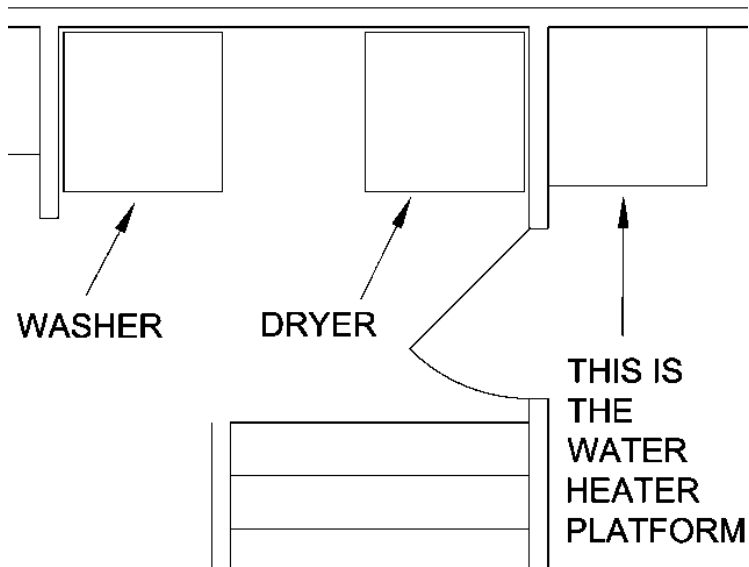

Fig 1-47

Now place the water heater on the platform (see Fig 1-49). Find the center of the square in the garage by drawing a **diagonal line**; draw a **24** inch diameter **circle centered** on the **midpoint** of the **diagonal line**. This is the same procedure that we used for the stove in Fig 1-24. **Follow the prompts**. If you are not finding the right osnap points, turn them on in the Object snap settings (see Appendix I—Object Snap).

**Erase the diagonal line.**

## 1.21 Text

We are ready to enter our text into the drawing. First **create a new layer** in the **Layer Properties Manager** and call it **Text**. Leave it white for now. **Set this Text layer as the current layer**.

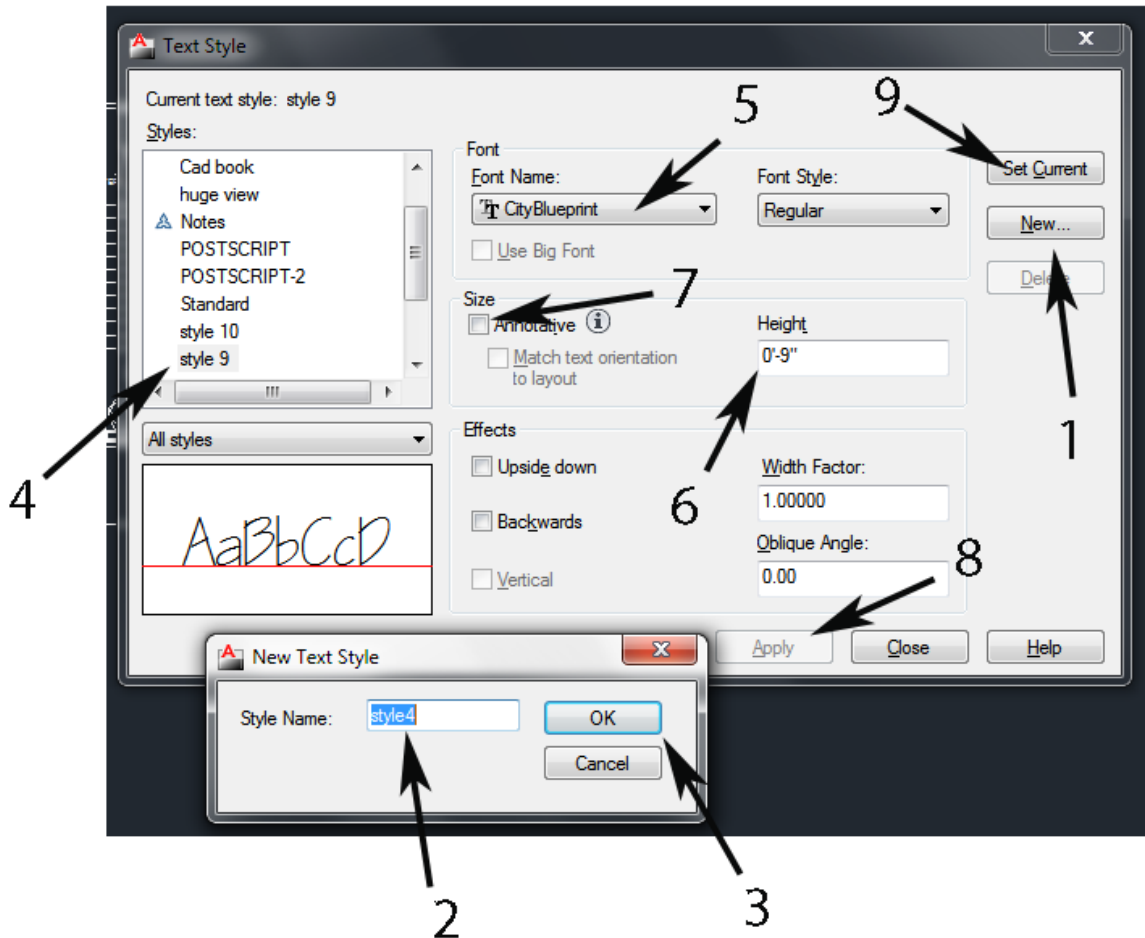

Fig 1-48

Now we must **create a text style**. Type: **style**. The **Text Style dialog box** will pop up (Fig 1-48). Click **New** (1 in Fig 1-48). **Name the style** in the window (at 2 in Fig 1-48), type: **style 9**. Then click **Okay** (3).

Back in the **Text style dialog box** **click the style 9 selection** (4). **Click** on the drop down menu under **Font Name** (5) and **select City Blueprint**. **Highlight the Text Height** (at 6 in Fig 1-48) and **over type: 9**. **Uncheck the Annotative** box (7). Click **Apply** (8), then **Set Current** (9), then **Close** (see Appendix I—Text for more info).

Type `mtxttoolbar` in the command line and enter a value of 1. This will turn on the text formatting tool bar.

We will begin with the room/space designations. Type `mt <e>` (mt stands for Multi-line text).

Click on the **space** in the **middle** of the **kitchen** and move the mouse up and to the right to **create** the (approximate) **text box** that is shown in **Fig 1-49**. Click for the second corner. The exact size and placement are not important.

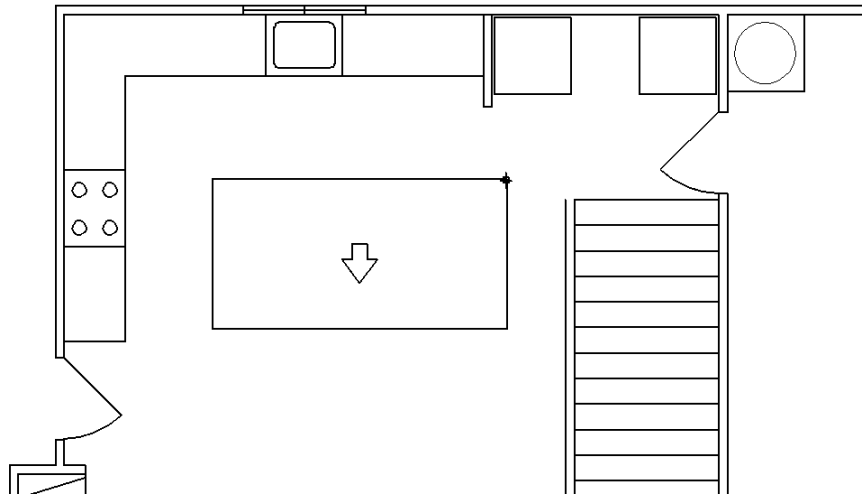

**Fig 1-49**

The **Text formatting bar** shown in **Fig 1-50** will appear.

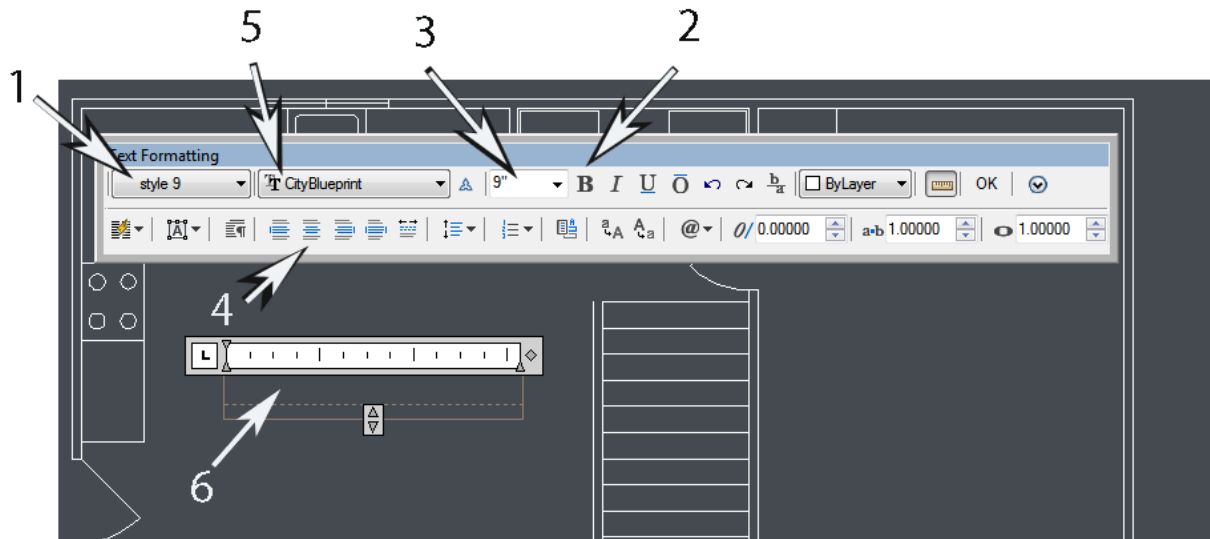

**Fig 1-50**

Set the **Caps Lock** on the computer keyboard (see Appendix I—Keyboard). **Select** your **style 9** (at **1** in **Fig 1-50**). **Click** on the **Bold** (**2**) button at the top of the bar. **Check** the **size** box (**3**) to make sure it reads **9**. If there is another number in this box then click on the number in the box, when it turns blue, **overtyp**e it with a **9**. Click on the **Center Text** (**4**). Check that the Font reads **City Blueprint** (**5**). If it is something different then you can change it in this window, but it is better to close this box, go back to Text Styles dialog box, and set it there.

Now type **KITCHEN** in the text box (**6**) on the screen. Click **OK**.

**Click** on the **Copy** button and then **click** on the word **Kitchen** <e>. The text (**KITCHEN**) must highlight before you can select it (if you have trouble selecting it then hover over it and move the mouse; you will see it change to

a highlighted lettering—this means it can be selected). Now copy the word to the (approximate) locations shown in **Fig 1-51**. (Turn the **Ortho off** and **Object Snap off**). **Esc** when you have copied them all.

If your text doesn't highlight, then see Appendix I—Selection Problems. Your system settings might be wrong.

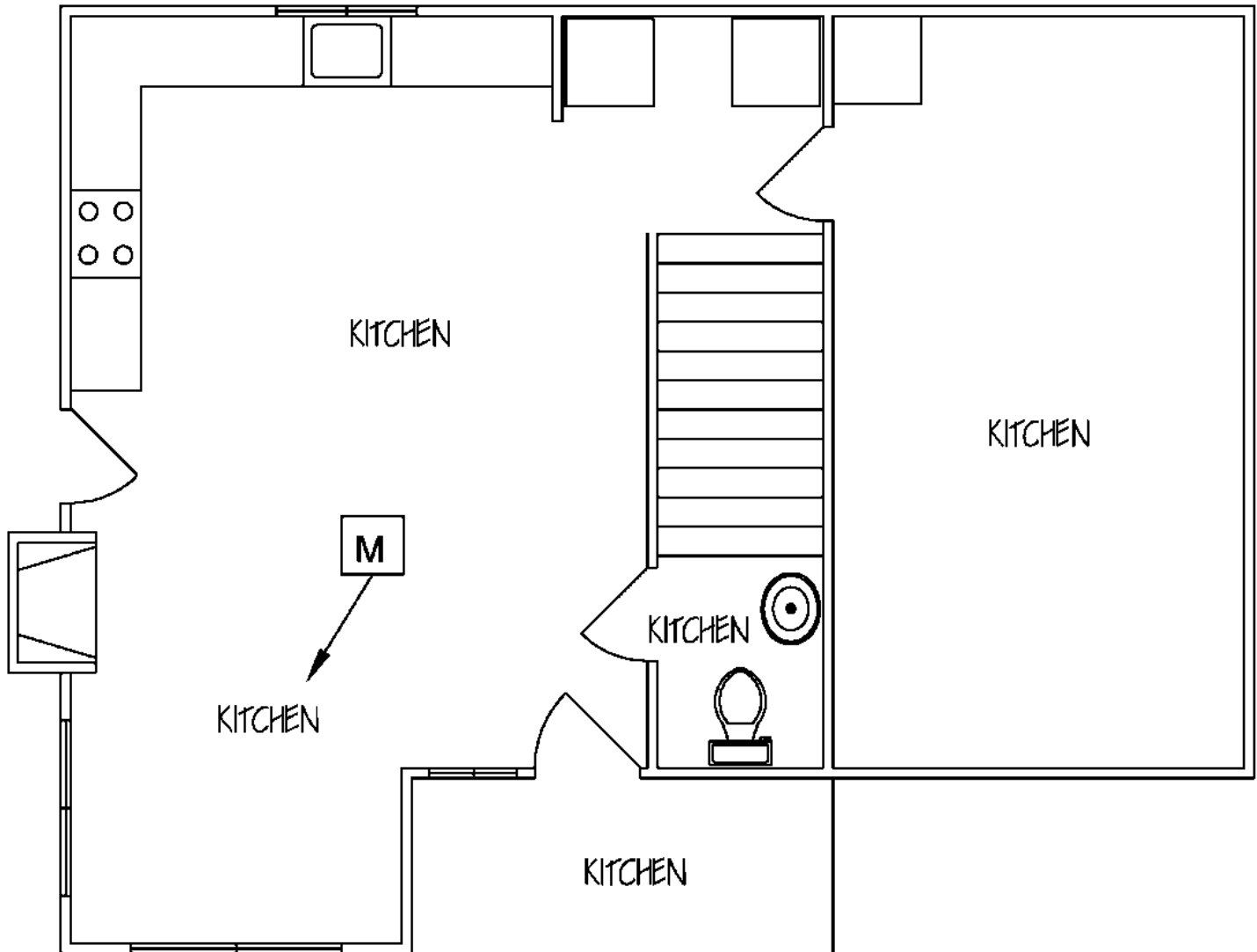

**Fig 1-51**

Now **click** on the lower left **KITCHEN** text at **M** in **Fig 1-51**. **Right click** and a drop down box will appear, choose **Mtext Edit**. The **Text Formatting** window will open as in **Fig 1-52**. **Highlight** the text (**KITCHEN**) by placing the cursor in the text box at **O** in **Fig 1-52** and press down on the left mouse button, hold it down, and scroll to the left. It will create a **blue selection window over the text**. Leave it blue and **overwrite it with: LIVING ROOM**. Click **OK**.



Fig 1-52

Repeat the text edit process with the rest of the text until the drawing looks like Fig 1-53. Click on each of the Kitchen texts, open the Text formatting box, highlight the text and over write it with the text shown in Fig 1-53.

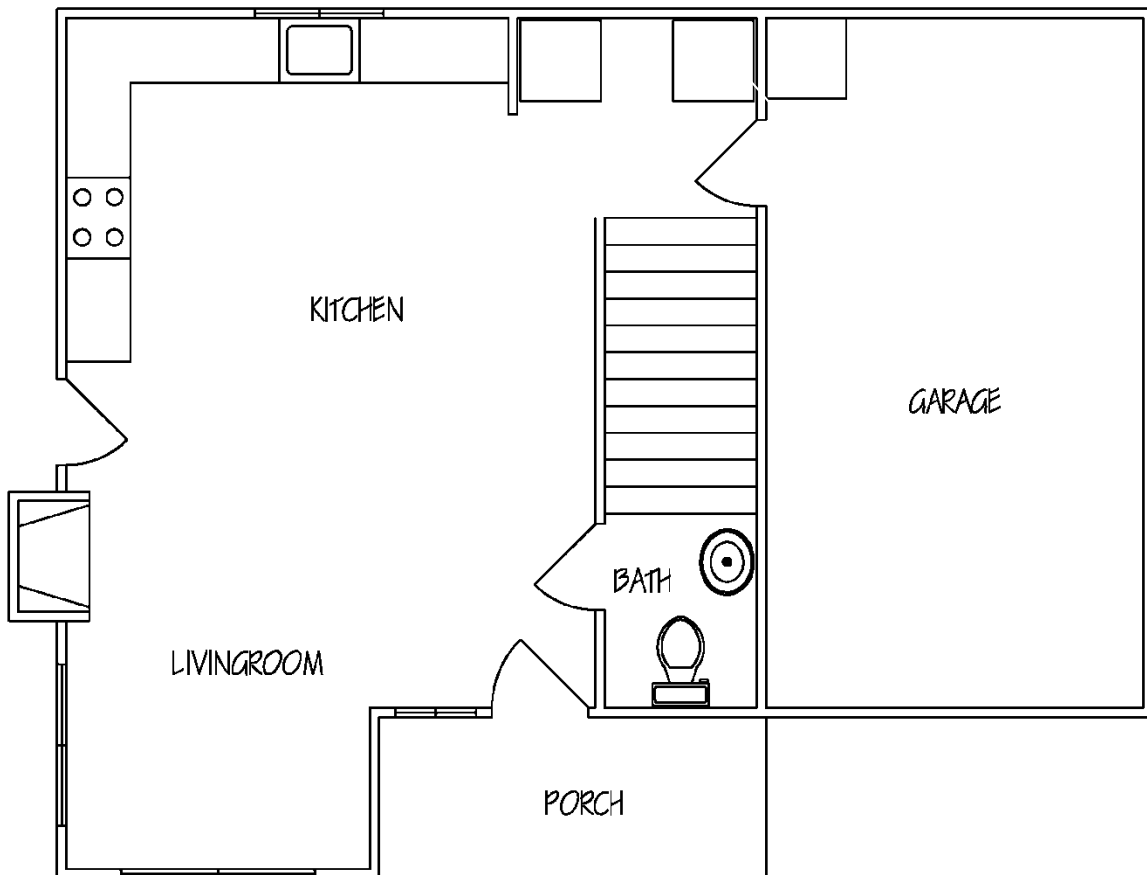

Fig 1-53

There are a lot of different ways to do each thing in AutoCAD. You can experiment with the different ways to approach the Text. I find this to be the easiest way to create multiple labels with the same properties. The standard way would be to open a new text dialog box for each piece of text. It is fine if you prefer that method.

Now we will create the window information text. Type **mt <e>**. Open another text box above the kitchen window at **Q** in Fig 1-54. Highlight the 9" in the text size box by clicking on it (it turns blue) and overwrite it with: 6 (see

Fig 1-50). Turn on the **Bold** button. Click in the text box (where the cursor is blinking) and type: **4-0 x 3-6 SLD**. Then OK.

If the text doesn't appear in a single straight line then adjust the length of the box using the grip at **P** in Fig 1-52 at the right side of the **ruler**. Place the cursor on the little arrows (or diamond) and hold down the left hand button on the mouse to grip the box and stretch it out to the right until the text appears on one line.

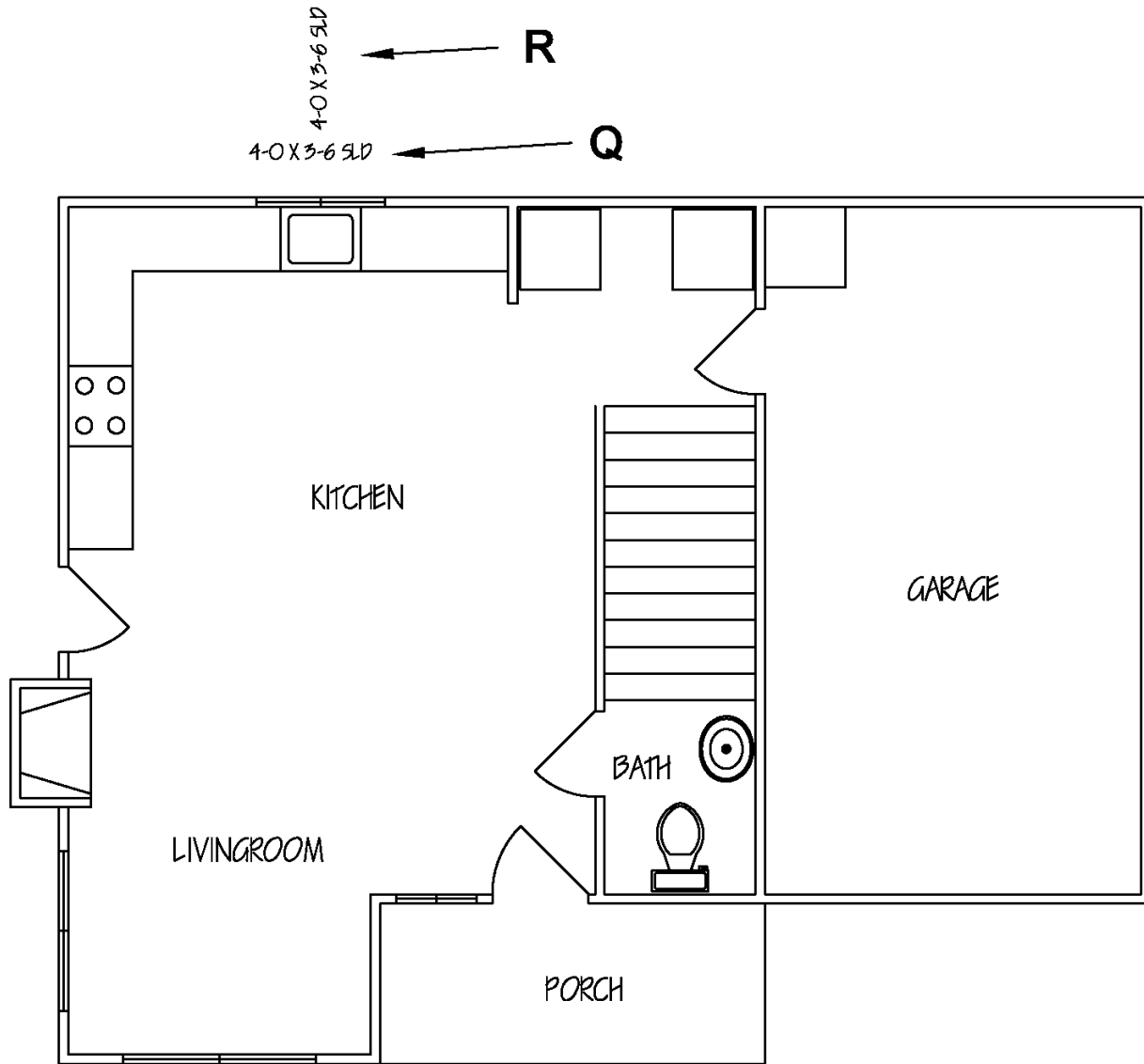

**Fig 1-54**

We are going to copy and rotate this text. **Copy** this text to the empty space above it as at **R** in Fig 1-54 (this Fig shows it after rotation). **Esc**. The exact location of the copy is not important.

**Click** the **Rotate** button and then **click** on the **text** that you just copied <e> (at **R** in Fig 1-54). **Click** again on this same **text**. (Read the prompt: **Specify rotation angle or...**) type **90** <e>. This will rotate the copy to 90 degrees as it appears in Fig 1-54. Now **copy** these two versions of the text to the places shown in Fig 1-55 (**Object snaps off**). Place the **text** by **hand** (no snap points—just place it by eye), roughly centered on the windows. Don't worry



about placing it exactly for now—you can do that on your own drawings later if you choose. I place most of my text by eye—just as long as it looks good it is fine. Setting text to precise points is covered later.

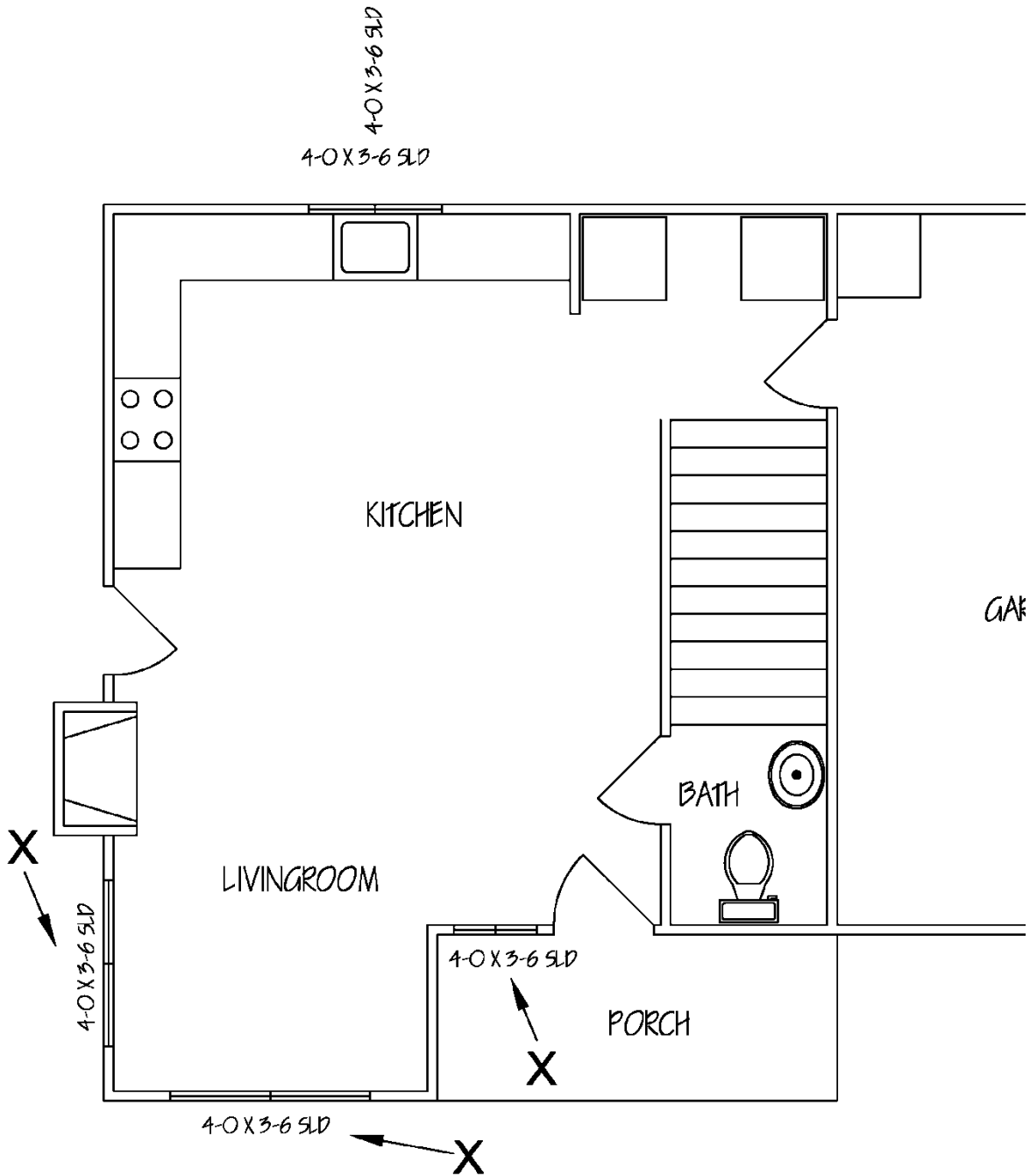

Fig 1-55

Click on each of the window size texts and edit them (highlight the text and overwrite it) to read as in Fig 1-56.

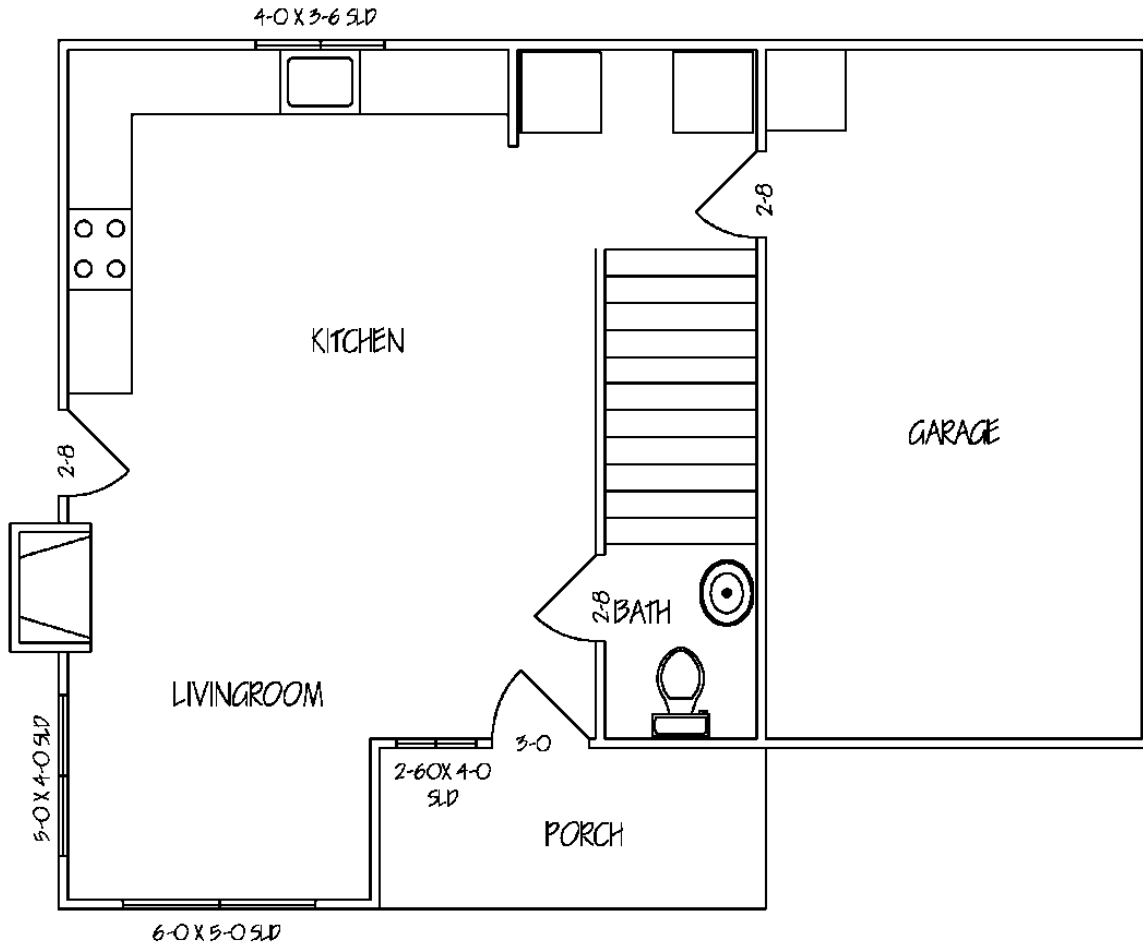

Fig 1-56

Use the **ruler** at the top of the **Text box (P in Fig 1-52)** to change the window label text on the porch to two lines as shown (you can also use the enter key between the numbers and the letters SLD to move them to a new line, as you would with any typing program). Check to make sure the **Text Centered** button is on (4 in Fig 1-50). If the text is not where you want it, click on the Move button on the Modify palette then use it to position the text where you want it (Ortho and Object Snap off). This doesn't always respond as it should, if you have troubles try stretching the text into one line, press the Center Text button, then shorten the box again.

Now **repeat** the process with the **door sizes** (use **6"** letter size and **Bold**); and with the washer (**W**), dryer (**D**) and water heater (**HW**) as shown in **Fig 1-57**. Use the **9"** text for these and **Bold**.

Now **add a note** for the **fireplace** as shown in **Fig 1-57**. Open a **mt** box and enter the information from the drawing below. Use **6"** letters and **Bold**. Use the Move command to position the text.

### 1.22 Odds and Ends

Okay we have just a few more items to add and the floor plans will be complete. Let's wrap up a few odds and ends. Turn on the **0 Layer**. Turn the **Ortho on** and the **Object Snap on**.

Close off the end of the wall at the stairwell with a short line (**Fig 1-57**).



Use the **Rectangle** tool and create a **box around the UP text** like the one in **Fig 1-57**. **Move** the **box** (just the box for now *not* the **UP text**) and place it on the end of the arrow (use the Osnap at the top midpoint on the rectangle). Now use the **Trim** tool ( Trim + rt click or <e>) to erase the line inside the box. Now **move** the **UP** text and place it in the **center** of the **box**. Do this by eye for now, we will discuss precision text placement later. **Erase** the **box** and **trim** the **arrow** to appear as shown in **Fig 1-63**.

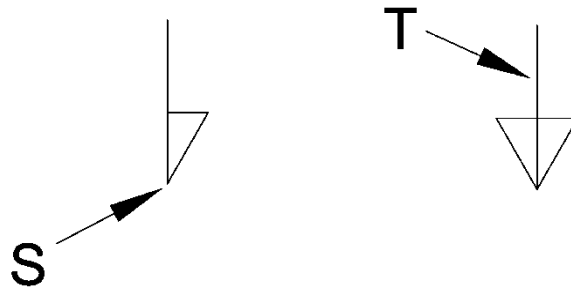

Fig 1-58

### 1.23 Dimensions

Now we are ready to enter the dimensions. We are going to use the non-annotative method. Annotative text is covered in Chapter 16.

To begin, create a **new layer** in the **Layer Properties Manager**. Name it **Dimension**. Leave it **white** (you can always change the colors of the layers at anytime). **Set** it as the **current layer**.

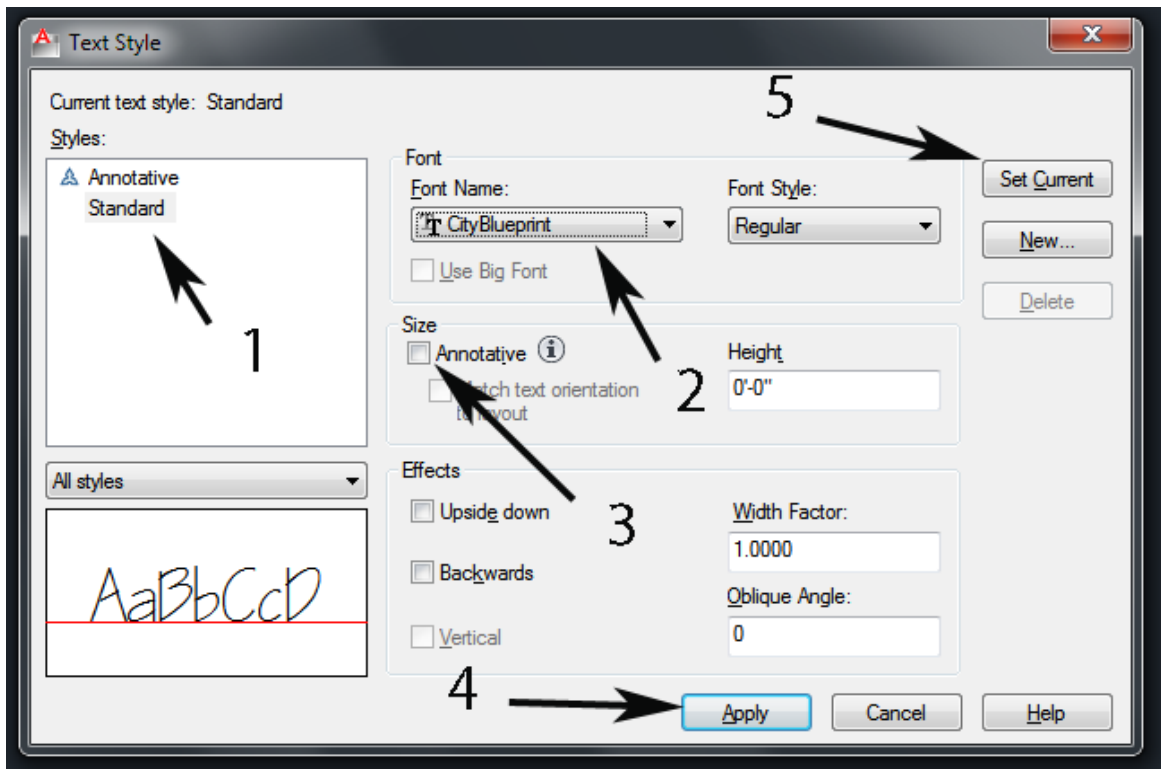
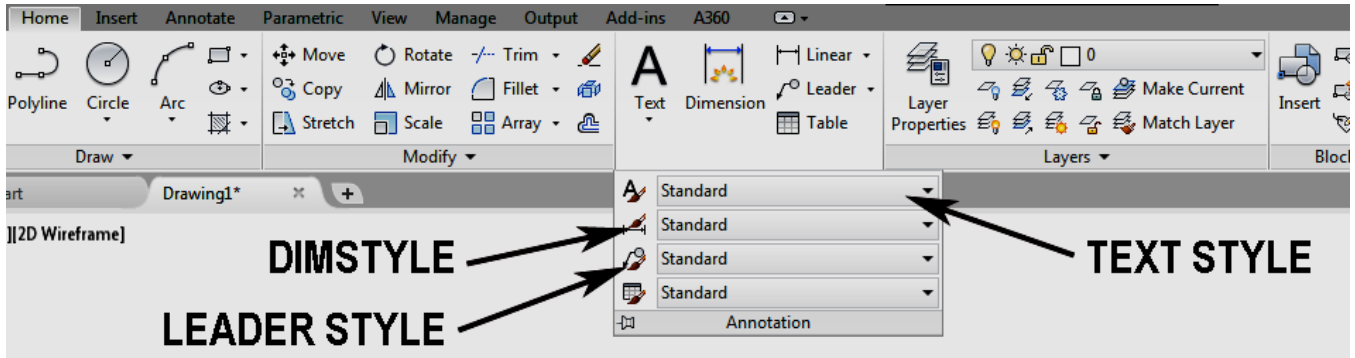

Fig 1-59

Type: **style <e>**. The **Text Style** dialog box will open as in **Fig 1-59**. Click on **Standard** (1 in Fig 1-59). In the window at **Font Name** (2 in Fig 1-59) scroll to **City Blueprint** and click. **Uncheck the Annotative** box. Click **Apply** (4) (if the **Apply** box is not highlighted then skip this step), then **Set Current** (5), and **Close**.



If you hover over the icons it will reveal their names.

Fig 1-60A

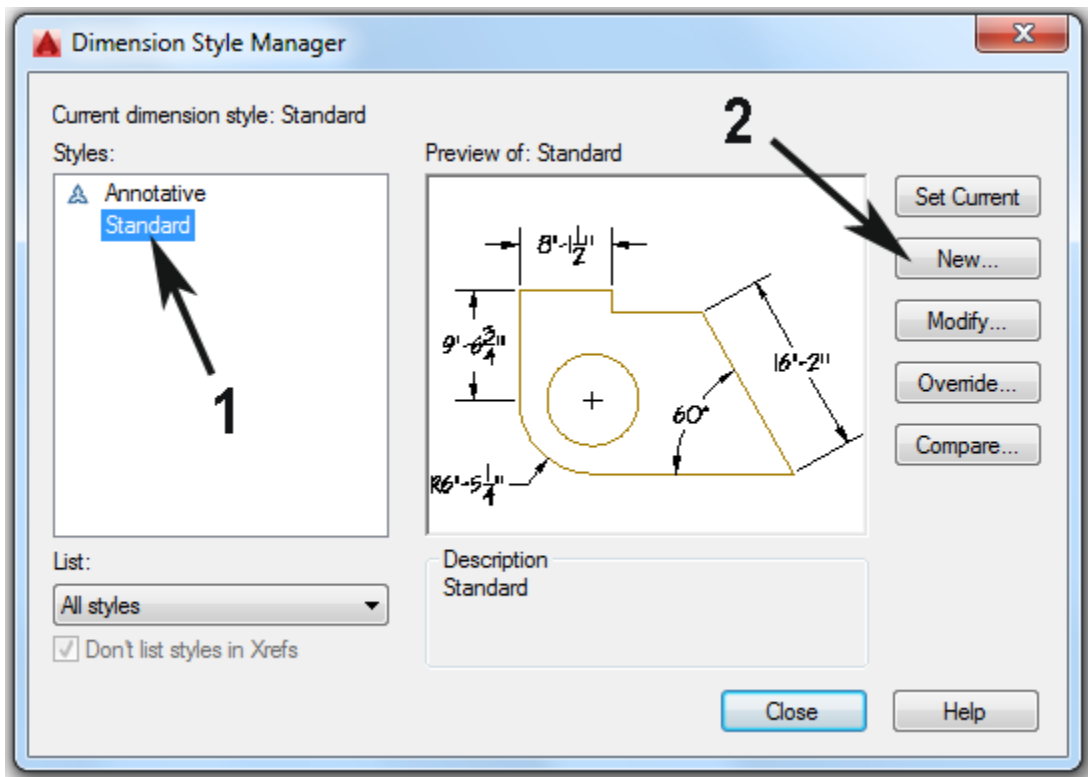

Fig 1-60B

Click on the **Dimension Style** button by clicking on the down arrow at the bottom of the **Annotation** palette next to the word Annotation (or type **dimstyle**). A dialog box will open. **Select the Standard style as shown in Fig 1-60A. Click New (Fig 1-60B).** When the **Create New Dimension Style** box appears **name this new style Quarter.** Then click on **Continue.** The **New Dimension Style: Quarter** box shown in Fig 1-61 will appear.

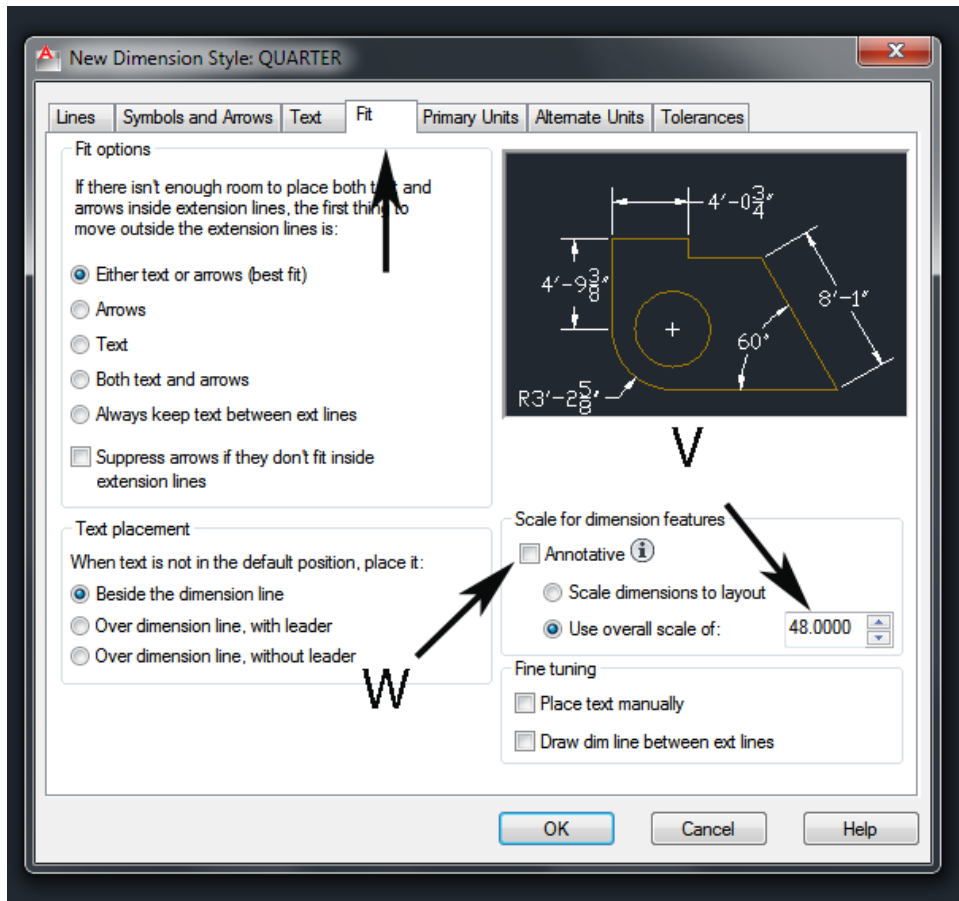

Fig 1-61

Click on the **Fit** tab. In the box that says: **Use Overall Scale of:** (**V** in Fig 1-61) highlight the number in the box (double clicking on it) and overtype it with **48**. Make sure the **Annotative** is turned off at **W** in Fig 1-61.

Click the **Primary Units** tab and make sure that **Architectural** is displayed in the **Unit Format** window.

Click on the **Symbols and Arrows** tab and in the **Arrowheads** window select **Architectural** tick. This should automatically change the second to read the same but if not then set it to **Architectural** tick in the second window also.

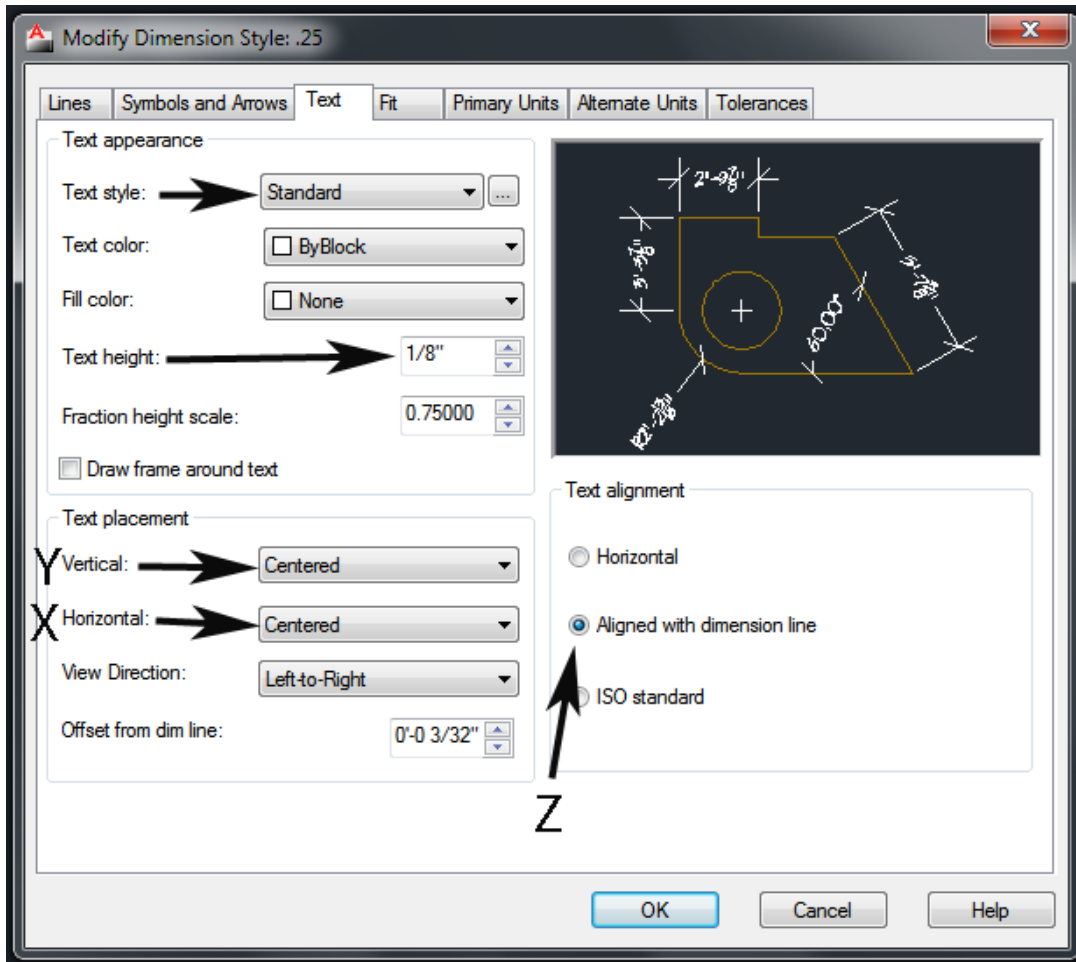

Fig 1-62

Click on the **Text** tab at the top of the box (Fig 1-62). Make certain that **Standard** appears in the **Text Style** window. Set the **Text height** to **1/8"**. Then below in the **Text Placement** box open the **Horizontal** drop down menu (X in Fig 1-62) and click on **Centered**. In the **Vertical** box (Y) select **Centered**. Turn on the button for: **Aligned with dimension line** (Z). Click **OK**.

Back at the **Dimension Style** box click on the **Quarter**, then **Set Current**, and **Close**.

In architectural design it is common to have the text (the dimension) above the line, but here we are centering to keep the drawings more compact so that these drawings will print out on a home/office printer.

This setup is for a dimension style using a quarter inch to the foot scale ( $\frac{1}{4}'' = 1'$ ). Later we will set up dimension configurations for other scales. Scales are discussed throughout the book and in detail in Chapter 13. You can read that chapter at any time for more info, but it may be a bit confusing without some more practice—this is a learn by practice method—so you can just follow along and all will become clear.

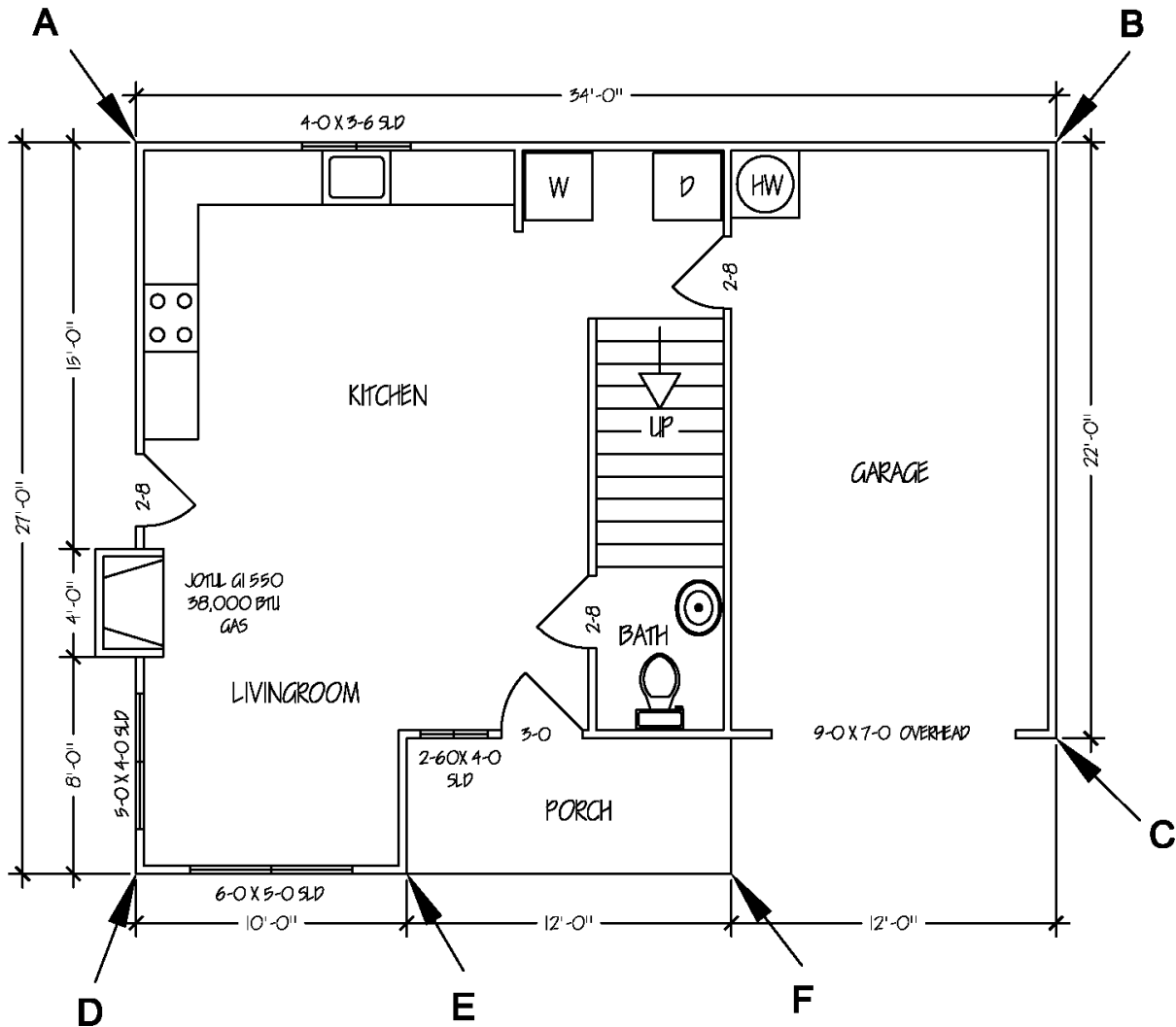

Fig 1-63

Now click on the **Linear** button on the **Dimensions** palette (on the Annotate ribbon co-located with Aligned, Angular, Arc Length, Radius, Diameter, Jogged and Ordinate—it could read any of these—click on the down arrow to see the list or type: dimlinear). Turn the **Object Snap** on and snap to the upper left corner of the building (**A** in Fig 1-63). Now snap to the upper right corner (**B**) of the building and move the mouse up. When the dimension line is approximately where you see it in Fig 1-63 **click** and it will set it in place. Keep these dimensions close to the building if you want to be able to print this out on a 8.5 x 11 paper (it just fits). You may want to move the kitchen window text—4-0 x 3-6 SLD—closer to the building first.

Now repeat this process on the garage wall to the right. **Click Linear** then point **B** then **C** in Fig 1-63, pull it out to the right, and **click** to set it in place.

You must be careful to **Osnap to the corner** of the building and **not to the end of the dimension indicator**. If you get a weird measurement that is probably what is happening. Zoom in if needed to differentiate.

Click on the **Linear** command and then click on the front of the living room, snap to the lower left corner of the building first (**D**) and then to the corner of the 10 ft pop out section (**E**). Pull it down and **set it** with a **click**. Now **click** on the **Continue** button on the **Dimensions** palette (co-located with the Baseline button) and snap to the



corner of the porch (F). **Do not enter or right click.** Continue on and snap to the outside corner of the garage (C) then <e>.

You should see the dimensions shown in **Fig 1-63**. This is the continuous tool that automatically aligns a string of dimensions.

At the left side use the **Linear** command to create the 8'-0" as shown in Fig 1-63, then the **Continue** button to create the 4'-0" and the 15'0". Use the **Linear** button to create the 27' dimension.

The Continue command saves you from having to click the Linear repeatedly when there is a continuous line of dimensions and it lines them up perfectly.

### **Congratulations you have finished the first floor plans!**

If you are going to produce the complete set of plans then you will add some more details to this drawing in Chapter 15.

### **2<sup>nd</sup> Story Floor Plan**

**It is not necessary that you draw the second story floor plans.** The dimensions and information that you need to continue this course are provided so that you can complete the chapters without drawing the second story.

If you want to draw the second story floor plans look at Fig 15-5 (in Chapter 15) and at the completed plans in Appendix IV, and repeat the steps in this chapter. The Index identifies where to find all of the necessary commands and processes if you forget how you did something.

If you are going to draw the second story floor plan, use the copy that you made of the drawing (Fig 1-15) and **make a new copy**. You will need more copies of this for other views later.

### **A Few Notes**

Here you have a completed floor plan and you now know a lot about how to use AutoCAD for drawing in two dimensions. There are a number of different ways to draw any particular object in AutoCAD. None of them are wrong. Readers of this book will develop their own style of drawing as time goes on. Some of what I have demonstrated here is not the easiest or fastest (or best) way, but rather the easiest to explain. The idea is to get you drawing what you need as quickly as possible and then you can fine tune your methods as you go along. Alternate methods for many of these techniques will be discussed as we go along.

Remember that all the commands can be typed in (as opposed to using the mouse and clicking buttons).

Take some time and look at the **Options** dialog box. Type options and <e>. Here you will find dozens of settings for many parts of the system. You can change the size or shape of the pick boxes for example. You can set the default for something other than inches (feet perhaps). You can set the default for line weight. Lots of options, most of which you will never need, but it is good to know what is available in case you find yourself looking for some esoteric setting.

Remember to **save your work often** as you draw. It is a (minor) tragedy to lose hours of work because of some strange computer glitch. Name this file **Paradise** (the fictional street name of our project) and save it to your computer. The desktop is a good place if you are going to be going at this course intensively.

There is an automatic save function find it in the **Options** dialog box (type **options**), then the **Open and Save** tab. Check the box next to **Automatic save** and set the **time between saves**—not too often because the program freezes while it saves your work—20 minutes is a good compromise. Check the box next to **Create backup copy with each save**.

Explore using right clicks as you draw. Use it to repeat commands and enter. Right clicks do a variety of things so the best way to learn about this is to right click at each stage of any process to see what happens.

