

An Eye on Mobile Computing

Dr. Akash Saxena¹, Dr. Navneet Sharma²

¹Professor, Dept. of Computer Science, Compucom Institute of Information Technology & Management (RAJ)

²Sr. Asstt. Professor (CS & IT Dept.), The IIS University, Jaipur (Raj.)

Abstract- In this immeasurable population on the planet earth the mobile system has become crucial need or we can say technology for us. So merging of technology and communication finds MOBILE COMPUTING. In general terms we know that mobile computing also comes to know as 'Human Computer Interaction'. In simple words we can say that to access data easily from anywhere at any time by the software system. Many researchers have been and can be implemented in the future related to the mobile computing issues, security etc. As when work increases expectation must increase from the client side. In this paper we can learn in short about mobile computing, its benefits, characteristics, issues and most important how it works along with the phrase "ANY TIME, ANY WHERE, ANY ONE".

Keywords: MSC, BSC, Inter cell, Handoff.

I. INTRODUCTION

Now a day's mobile system seems to be like a human needs food to survive. Firstly a question arise in our mind that what is MOBILE COMPUTING? And the simple answer comes in front of us is, it is a Human Computer Interaction by a system over a network, along with the phrase "ANY TIME, ANY WHERE, ANY ONE". This phrase means ANY TIME stands for mobile communication system must available every time. A person can use it always, whether day or night, mobile services should be available 24x7. Now ANY WHERE means the mobile services and signals must be user friendly as well as environment friendly too, means a user can roam anywhere any places with their system like (laptops, mobile phones or any other portable device). At last ANY ONE indicates that a user can contact with different users it does not have any limitations to communicate with a single user only. Now in general MOBILE COMPUTING is a human computer interaction which allows to access data from the software system means any portable device (wireless) at anywhere. The transfer of data or the data which is to be access may be a audio, video, voice call etc over a network. The devices may connect with the LAN, Wi-Fi to be connect with the present network for the transmission and communication of data over that network only. As the mobile system consist of portable device that's why it does not uses the cable wires or any other connecting wires.

1.1 The main components by which it is made up of is:-

- Mobile hardware
- Mobile software
- Mobile communication

Mobile hardware defines as it consists of the screen size, model number, name, storage, memory, microprocessor, durability, special features etc overall it indicates the infrastructure of the system.

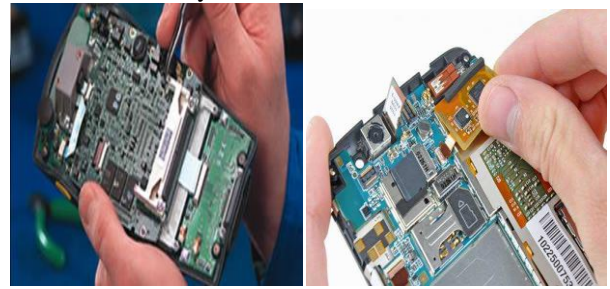

Fig 1. Mobile Hardware Infrastructures

Mobile software defines as it consists of the latest application, browsers, on which users are communicating. It may be MsDos, WINDOW3.1/95/98/NT, UNIX, and Android. And other wide variety of system, application software along with the operating system. Mobile communicating defines as the way in which a mobile system is communicating with a fixed information system. It can be classified by

- Connected -Availability of high speed connection to communicate.
- Weakly Connected- Slow speed of network to communicate.
- Batch - Not continuously available to communicate it only established randomly to exchange and update information between the fixed information system and portable device.

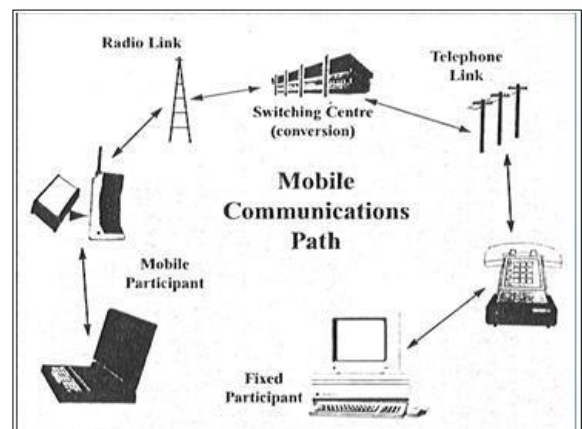

Fig.2. © Mobile-communication system

- Disconnected - Improves the planning by calculating, storing data of the information, keeping a schedule and other tasks related to communication.

II. MOBILE COMPUTING BENEFITS

As mobile computing is not describes in a few words because of its valuable works uses and all. Following are some benefits apart from a huge value of mobile computing now a day:-

- Location adaptor
- Less Time consuming
- Peace in research
- Process enhance in business
- Cost reduction
- Other field uses

A. Location Adaptor

In location adaptation user can do their work from anywhere at any place weather in office in home etc. user need not to roam here and there to complete their task they can just complete it placing on a fixed position also over a network with their portable device which is always with them only. User can do multiple tasks at a time only as compare to earlier by reaching various places and then do their work. So overall a user can do anything in work at a fixed position till the connection lost. Connection is established to complete the task over the network.

B. Less Time-Consuming

In time consuming stuff mobile computing plays a very important role because for today's world time is more important in spite of anything for them. So mobile computing slash all the extra time as to complete the work from a fixed position only over a network. Even they don't have fear for their data loss data security and all because mobile computing establishes a secure connection for the user to communicate and transfer the data from one to another user. It also enhanced the telecommunication in many business companies. We can also say that by this we are saving not only the time but our cost also.

C. Peace in Research

Peace in research means earlier the researchers have to move from one place to another for their research stuffs they firstly go to their collect the information and then merge them all to find the appropriate result but by mobile computing and mobility it is easier for them to collect the data multiple data at a time and then easily prepare feedback for the further works. It helps the field researchers to elaborate the research and give them an appropriate result in less time as compare to roam here and there for the knowledge about that research.

D. Process Enhance in Business

Increasing process in business also plays a vital role in mobile computing phenomena many business are spread all over the world with different branches a client or any higher authority

doesn't able to entertain all of them equally at a time. But by cloud computing it is possible for the clients higher authorities to do their work remotely by accessing appropriate data. Meetings, presentation and other business works done globally at a time by the secure connection along with authentication and authorization.

E. Cost Reduction

In cost reduction like if a user roaming here and there from one place to another to collect the entire ingredient and then merge it to find a complete task. If must have to spend more cost on that all stuffs like vehicle cost, paper cost etc. by mobile computing it is easy for them to invest at one place to access the multiple data at a time only.

F. Other fields

Last but not the least in other fields like entertainment field the wide range of movies, audio, video can be downloaded. The best example in today's world is mobile TV. The recordings on the streamed on wide range of data information is to be stored yet to use. But it is also true that for better work we have to spend some cost more than the current one. For fast data speed the connection must be established like the large amount of data is stored easily in less amount of time interval.

Overall, mobile computing helps us to do our work in time by the less loss of time, physical stress etc. If mobile computing doesn't matters now a days it can't be easier to do all the work like transmission, telecommunication, recordings, data remote access etc.

III. MOBILE COMPUTING CHARACTERISTICS

The following basic characteristics of mobile computing are as follows:-

- Portability
- Social Interactivity
- Context Sensitivity
- Connectivity
- Integrity

The word portability defines as a user can move there system anywhere at any place on the planet with themselves only and access data within the network.

Social interaction means a user can share data to other multiple user at a time over the current network they are accessing that time only to any place remotely. Context sensitivity stands for like a user is not in a fixed location so this category the signals must gather and responds to the current location and file to the user in the system.

Connectivity denotes as an user can connect their device via any network safely and communicate easily with the other users.

Integrity means correctness of data which is accessing viewed to both the user at a time over a network. Denote compilation of task via network.

IV. AVAILABLE TECHNOLOGY

Technologies of mobile computing are increasing day by day. Following are the technologies of mobile computing:-

- WLANs
- Internet
- Satellite
- Docking
- Disk swapping
- Cellular digital packets
- Personal communication system
- Global system for mobile communications
- Infra- red

A. Mobile Computing Issues

- Confidentiality
- Integrity
- Availability
- Legitimates

Confidentiality prevents the unauthorized user to access or read the current data present into the file system. Because while we are accessing the data many treats, hackers or a third party get ready to access our data frequently in between the network so it is necessary to took the data confidential.

Integrity refers to the completion of work like if a user can call somewhere the call transmission and voice call transmission must be completely executed both sides. Completion of whole task at both sides is checked in these categories if not then it will be a network issue for the mobile computing device.

Availability refers to check that the authorized user are getting the appropriate service or not over the network. In this a user get a wide range of data but the services they need is to be fulfilling correctly or not is checked in this category.

Legitimates refers to the category in which only authorized user can access the data. Mobility contains a large amount of data but can be access by only the authorized user it may be by a user id and password or other security techniques.

B. Business Issues

It is important to take a look on the business strategies because security of data and plans is much more important for their products. Mobile computing here also plays a vital role to deny the problem of the users in business.

As we know that any companies in business field doesn't share their data to any others in market because of the competitors in this competitive world. And if the security on data will be weal it is cent percent sure that the hackers easily takes the data from there modify it and use in their own resources. This is highly not applicable for the authority to be authenticated.

The companies must take following major steps for preventing their data to be use by the third party and threats.

The steps are as follows:-

- The security and functionality of hardware and software must be strong which can't be able to defeat by the threats.
- User must be software friendly as they must be able to know all the process of using that product.
- Recruitment of employees must be more knowledgeable as they can understand the logics and tricks of hackers.
- The product's features security must have to be in enhanced way day by day.
- Copyright and authentication must be correctly done by the business head.

V. CURRENT INCLINATION

Mobile computing has trend increasing day by day different techniques, different aspects, and different features in them. Following are some of the current inclination of mobile computing:-

- 3G
- GPS
- LTE

A. 3G

3G stands for THIRD GENERATION MOBILE TELECOMMUNICATION service. This is totally completed by Telecommunication-2000(IMT-2000) which is designated by ITU (International Telecommunication Union). Services provides are voice calling, audio, video, wide range of data to be stored etc. in the portable device.

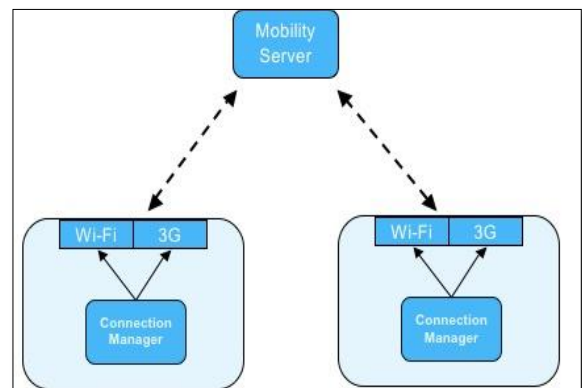

Fig.3. 3G Service

B. GPS Services

GPS stands for GLOBAL POSITIONING SERVICE based on space functionality along with works on satellite navigation. It is widely useful for the indication of the correct location and other information related to this at anywhere anytime on the

planet where at least four to five GPS is established connected to the satellite.

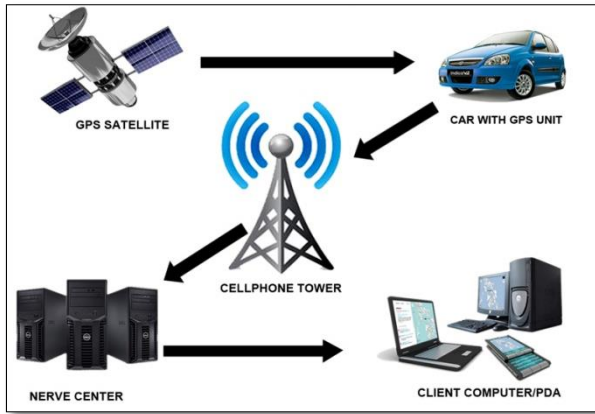

Fig.3. How to GPS Works

It is use mainly in the police station, civil, military and other commercial use. It is also known as the model of modern global air traffic system.

C. LTS Services

LTS stands for LONG TERM EVOLUTION service. It is use to communicate the data speed strength. Communication of high speed data to the data terminals service provided in the portable device. Widely use to increase the capacity and speed range and signals of data using new techniques in new technologies. It is mainly related to 4G networks.

VI. WORKING FUNCTIONALITY OF MOBILE COMPUTING:-

As earlier we have discuss about the mobile computing, objects, issues etc. now we will discuss about the function of the mobile system how the mobile screen displays the message of changing the location to the user.

As mobile system works through a wireless channel that's why a user who may called as a processing unit can takes their mobile device at anywhere with themselves. Let us assume the processing unit(user) is from Punjab and he is going towards Haryana after entering the Haryana zone he sees a message of "WELCOME TO HARYANA", do you think what functions are running into the back end of the system software?

The answer is a location is having two work station named as MSC (Master Station Controller) and second is BSC (Base station controller) the second one may be called as substation because it works under MSC.

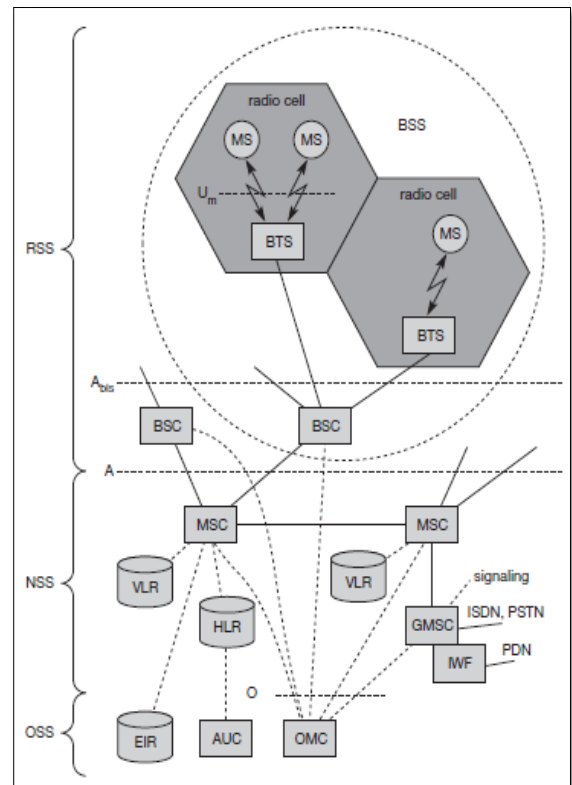

Fig 4. GSM Architecture

Our mobile station send 1kb message to the server from where it would take its services to communicate. This is shown in figure1 GSM Architecture. BSC checks the location changes because last location was Punjab and this location is Haryana sends message back to the MSC of Haryana which contact MSC of Punjab that the user in their location needs which services their system have to allow the same services their also. Now

BSC allows the services activation in the current location all the data are going in mobility database or mobile management and PSTN (public switched telephone network) .and lastly user can access data and information from the current location via network.

Here two conditions apply:-

- Handoff
- Intercell

Handoff condition occurs when BSC or MSC of current location communicate with other location are known to be BSC Handoff and MSC handoff respectively.

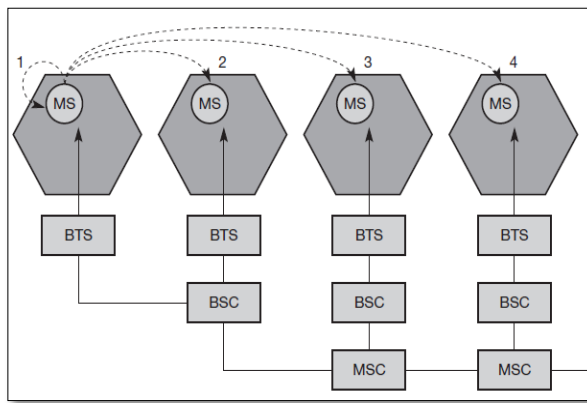

Fig 5. Intercell/ Intracell

We can say that it is a process of transferring an ongoing call or data session from one channel connected to the core network to another. The channel change due to handoff may be through a time slot, frequency band, codeword, or combination of these for time-division multiple access (TDMA), frequency-division multiple access (FDMA), code-division multiple access (CDMA), or a hybrid scheme. Handoff is also called as 'Handover'.

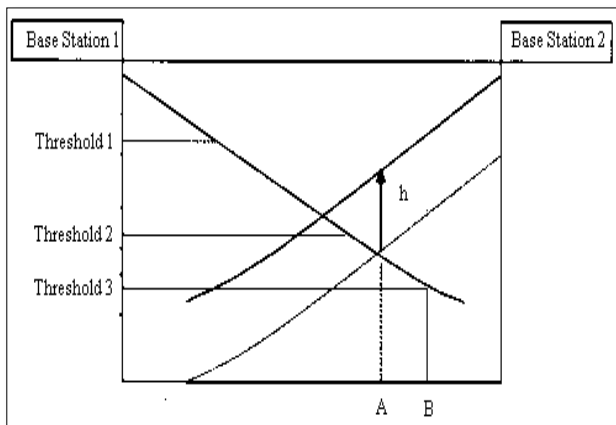

Fig.6 working of handoff.

Inter cell communication refers or occurs when BSC of same location switch to other BSC of that location only termed as inter cell communication.

Sometimes a user can face the problem of signal delay that means when BSC allows the services on the system one by one the signals may blink again and again but when the whole process stops the blinking of signal on the mobile system stops and a user can communicate with other user easily.

VII. CONCLUSION

In this vast world according to the uses of mobile system is increasing day by day so the process, functions involves in this must increase their security status. The delay in the transmission or transferring of data, call, files is to be improving in time consumption clarity etc.

And the statement always be in mind i.e. if mobile computing will not work better more day by day, it might not be prevent its function from different threats. Because we all now comes to know that when on a network implementing of connection also damaged by the threats.

“BING TO BE BEST THEN BETTER TECHNOLOGY MOBILE COMPUTING MUST BE ENHANCE PROPERLY”

VIII. REFERENCE

- [1] A Jain, A. Dubey, R. Gupta, and N. Jain, “Fundamental Challenges to Mobile Based OCR,” *Int. J. Innov. Res. Stud.*, vol. 2, pp. 86 – 101, 2013.
- [2] B. Svendsen, “Mobile Computing,” in *Science*, 2004, pp. 169–184.
- [3] C. Cuddy, “Mobile computing,” *J. Electron. Resour. Med. Libr.*, vol. 6, pp. 64–68, 2009.
- [4] K. Prakash and Balachandra, “Security Issues and Challenges in Mobile Computing and M-Commerce,” *Int. J. Comput. Sci. Eng. Surv.*, vol. 6, pp. 29–45, 2015.
- [5] M. Mulugeta, Security Issues of Mobile Application Using Cloud Computing, vol. 334. 2015, pp. 147–161.
- [6] G. H. H. Forman and J. Zahorjan, “The challenges of mobile computing,” *Computer (Long Beach, Calif.)*, vol. 27, pp. 38–47, 1994.
- [7] M. Satyanarayanan, “Fundamental challenges in mobile computing,” in *PODC '96 Proceedings of the fifteenth annual ACM symposium on Principles of distributed computing*, 1996, pp. 1–7.
- [8] C. Eckert, “Security issues of mobile devices,” in *Security in Pervasive Computing*, vol. 3450, 2005, pp. 163–163.
- [9] D. Van Thanh, “Security issues in mobile ecommerce,” *Proc. 11th Int. Work. Database Expert Syst. Appl.*, pp. 467–476, 2000.