

Reindeer Notes



No, I'm just Canadian!

Hey, aren't you Santa's younger brother?

Have you been **naughty**
or **nice**?



NEXT MEETING:

THURSDAY, DEC. 20TH 6:00 P.M

LOGAN'S ROADHOUSE, SHELBYVILLE RD.

2012 IPMS/USA Region IV Newsletter of the Year!

To contact MMCL:

President:
Stu "Dancer" Cox
Email: Scox2010@gmail.com

Vice President:
Dr. Terry "Prancer" Hill
Email: Thill35434@aol.com

Secretary:
David Knights
Email: LOULAW@AOL.COM

Member at Large:
Noel "Comet" Walker
Email: CWalker011@aol.com

Treasurer:
Alex "Cupid" Restrepo
Email: scox6618@bellsouth.net

Webmangler:
Mike "Rudolph" Nofsinger
Email: Mnofsinger@insightbb.com

"Tactical Notes" is the Newsletter of the Military Modelers Club of Louisville, Inc. We appreciate your taking the time to read this little newsletter. We'd appreciate it even more if you would write something. **Yes, I am talking to you!**

Cover Photos: Cranky Canadian Jim Bates with Scott Hards of Hobby Link Japan at the 2012 IPMS/USA Nationals in Orlando FL.

Editor's Note

For those of you looking here for a report on what happened at the last meeting...Sorry. For the second month in a row I was out of town on the meeting night. I don't think I've missed two meetings in a row in years.

On a positive note, I will be at the meeting this month. The fact that there will be steak available at this meeting has nothing to do with that. Really. This month's meeting is our annual Christmas dinner at Logan's Steakhouse on Shelbyville Rd. Everyone is responsible for their own dinner cost. Families are welcome. In fact we encourage families to attend.

This issue of Tactical Notes has a somewhat lighter attitude to it. I hope to carry this on in future issues. Since this is the last issue of 2012, I'd like to take a moment to thank all of those who contributed articles in the last year. I particularly want to thank Dennis Sparks and Jim Bates, without whose regular monthly contributions, I'd have a lot of empty space to fill.

We are at 50+ paid members for 2012. I know we can do better. Let's set a goal of 65 members for 2013. Let's make 2013 "The year of MMCL"!



Aircraft of the Aviation Museum of Kentucky: Douglas A-4L Skyhawk, BuNo 147708

By Dennis Sparks, MMCL Eastern Bloc Commisar

The Skyhawk was designed in response to a 1952 US Navy specification for a jet powered ground attack aircraft to serve as a replacement for the piston-engine Douglas AD (later A-1) Skyraider. Chief designer Ed Heinemann opted to minimize the Skyhawk's size and complexity, resulting in an aircraft that was only half of the weight limit that had been imposed by the Navy. It's diminutive size and agile performance was reflected by the many nicknames bestowed upon it, including Bantam Bomber, Heinemann's Hotrod, Kiddiecar, and Scooter.

First flown in June 1954, it began entering service with Navy and Marine squadrons in late 1956. They were heavily used during the Vietnam War and remained in US military service for four decades, with the last of the 2960 built being delivered in 1979. While it was withdrawn from use as an attack aircraft by the Navy in 1976, it continued in that capacity for a number of additional years with the Marines, and it continued to fly in other roles until 1998. Skyhawks have also seen service in the armed forces of Argentina, Australia, Israel, Kuwait, New Zealand and Brazil.

Bureau Number (BuNo) 147708 was originally constructed as a radar-equipped A4D-2N with limited night and all-weather capabilities. It was accepted by the Navy at the Douglas factory at El Segundo, California on 29 April 1960, and was soon assigned to VA-44 at Jacksonville, Florida. While nominally an Attack Squadron, the squadron was at that time functioning as a Replacement

Air Group (RAG) Training Squadron, training both aviators and maintenance personnel for fleet squadrons. When the Department of Defense instituted a common



numbering system for all US military aircraft in 1962, the aircraft was re-designated as an A-4C.

In September 1963, the aircraft was re-assigned to VA-76. While with this squadron, the aircraft served two tours aboard the USS Enterprise (CVAN-65). From February to October 1964, Enterprise was on station in the Mediterranean off Cyprus during a flare up between Greek and Turkish Cypriots. A year later, VA-76 was aboard Enterprise while on station off the coast of Vietnam. However, 147708 left Enterprise and VA-76 in January 1966, possibly for repair or overhaul. Cumulative flight time by this time was 2044 hours, including 207 hours and 79 arrested landings during the aircraft's second tour aboard Enterprise.

VA-76 was to later figure in two milestones for the Skyhawk while in service in the skies over Vietnam. One of their A-4s was shot down by a North Vietnamese MiG-17 on 25 April 1967. A week later, Lt. Cdr. Theodore Swartz returned the favor, shooting down a MiG-17 with an unguided 5" Zuni missile. These were the only air-to-air loss and victory credited to the Skyhawk during the Vietnam War.

After brief stops at Cubi Point, Philippines and Atsugi, Japan, BuNo147708 was assigned to VA-144 aboard the USS Ticonderoga (CVA-14) as they were finishing their second Vietnam combat tour before returning to their home base at NAS Lemoore,

CA in June of 1966. In September, 147708 again embarked with VA-144 for their third combat tour in Vietnam, this time aboard the USS Kitty Hawk (CVA-63). Kitty Hawk remained on station off Vietnam until June 1967.

In 1965, two USN squadrons of A-4s were formed to serve a very unusual role for the Skyhawk. VSF-1 and VSF-2 were intended to be oversized squadrons that would furnish detachments for combat air patrol duties aboard aircraft carriers that were tasked with anti-submarine duties.

144708 joined VSF-1 in August 1967, and was assigned to the USS Independence, which was then undergoing a refit at Norfolk. But by the time the ship was ready to depart for a cruise of the Med in April 1968, VSF-1 had been split, and 147708 was instead sent to NAS Alameda to become part of the newly-formed VSF-3. However, with the escalation of the war in Vietnam and the pressing need for A-4s in their normal attack role, the Skyhawk's VSF role was abandoned.

While assigned to VC-7 in January 1970, the aircraft was selected to be one of the 100 A-4Cs that were upgraded to become A-4Ls. In August 1970, it joined VA-209, a naval reserve squadron based at Glenview. When that squadron was disestablished a year later the aircraft was assigned to VC-12, a composite squadron based at NAF Detroit. Like

VC-7, VC-12 was tasked with fleet support roles, including Dissimilar Air Combat Training (DACT), providing training for carrier-based detection and interception, target towing, and radio/radar systems calibration and testing.

In June 1976, it joined VA-204, a reserve squadron based at NAS Memphis, TN. After almost eighteen years of service, it was retired from active service in January 1978 as the squadron began converting to the A-7 Corsair II.

It apparently remained in storage at Memphis for more than ten years before being acquired by the Aviation Museum of Kentucky (AMK) in the autumn of 1988. The following spring, four members of the paint team for the US Navy's Blue Angels came to Lexington to paint the aircraft in its current Blue Angels scheme. They removed the large dorsal avionics hump and several smaller items that had been added during its conversion to A-4L standards, then sanded and painted the aircraft. Lexington's Mike Nord had been a member of the Blues for three years, serving as the pilot for the number 4 aircraft in his final year of 1978, and so the aircraft was painted with Mike's markings, although retaining its assigned Bureau Number.

While the Blue Angels flew Skyhawks for eleven years, they never flew any of the A-4C or A-4L versions with the 7700 lb. thrust Wright J-65 engine. Beginning with the A-4E

model, the engine was changed to the Pratt and Whitney J-52. This engine was updated several times, from the original 8400 lbs. thrust up to an eventual 11,200 lbs. The Blues flew a modified A-4F version that was dubbed the "Super Fox", which had the most powerful engine variant, and was not fitted with the dorsal avionics hump that was common to the later versions. Other than this hump, the primary external visible difference is that the engine air intakes were both larger and slightly repositioned on the later versions.

In 1989, the museum's only "real estate" was a pair of glass showcases in the terminal at Blue Grass Airport. One of the ideas discussed involved mounting the freshly painted aircraft on a pylon near the entrance to the airport. But the aircraft was instead stored in a hangar to await the purchase of construction of a building for the new museum.

The museum acquired its first home in late 1994, and officially opened in April 1995. BuNo 147708 was one of the museum's first aircraft to go on permanent display, and was there when sixteen members of Doolittle's Raiders were on hand for the opening ceremonies. Like all of our retired military aircraft, it is on "permanent loan" to the museum. It remains the property of the National Museum of Naval Aviation in Pensacola, Florida, and the AMK is required to submit annual photographs as proof that it's being maintained in display condition.

* * *

Book review: Spitfire Leader:

The story of Wg Cdr Evan
"Rosie" Mackie

By Max Avery with
Christopher Shores

ISBN: 1-902304-26-8

188 pgs

16 pgs bw photos

Review by D. M. Knights IPMS/
USA 17656, IPMS/Canada C6091

I am a huge fan of Chris Shores and his sometime co-author Brian Cull. I am working my way thru the books that either of them have written. I will admit that I was unaware of this title until it was suggested by Amazon due to the other Shores' books that I had ordered in the past.

As the title suggests, the book is the story of Wg Cdr Evan "Rosie" Mackie DSO, DFC and Bar DFC (US), one of the highest scoring RNZAF aces. He fought in England, Africa, Sicily, and Europe. He ended up a Wing Commander with 21 ½ to 25 kills depending on how you count. I will admit that I'd never heard of Wing Commander Mackie before this book and that is a shame. He is an impressive person who rose from a humble background, went to war when duty called and when the war was over he returned to his homeland to contribute to society with the skills he had acquired prior to the war, giving up flying completely.



Like many of his generation, he grew up in great poverty. He was mechanically inclined which came in handy in working his way up the employment ladder. Wg Cdr Mackie was one of the pilots who, due to his mechanical background, had great respect for the squadron maintenance personnel. In fact, he spent spare time giving hop rides to the ground personnel. He also emphasized to his pilots the need for them to learn the mechanical features of their airplanes.

The book describes each of Mackie's kills in detail including his own words in his after action reports. In several cases, the authors are able to identify Mackie's victim, making for a good "dogfight double" for the modeler. Mackie flew a number of different versions of the Spitfire as well as the Tempest V. This gives the modeler a number of choices if

he chooses to model one of Wg Cdr Mackie's aircraft.

The book has a number of photos from different parts of Mackie's life, with emphasis on the war years. There are several photos of his various aircraft. A couple of color three views of Mackie's different aircraft would have been nice from a modeler's perspective, but I understand why they aren't there.

This book was a great, very quick read. I was hooked from the first moment I started reading. I highly recommend this book. * * *

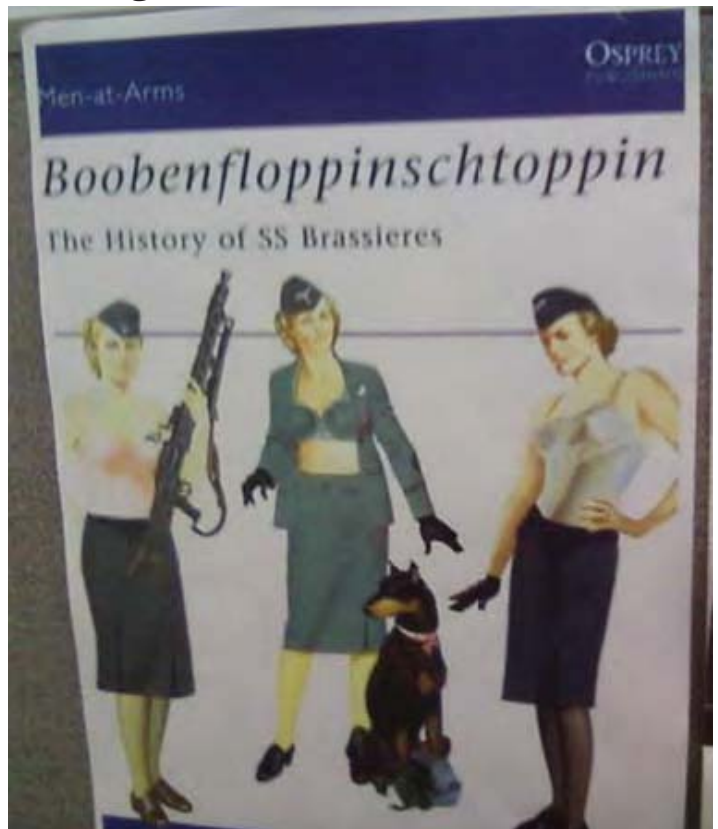

BOOBENFLOPPINSCHTOPPIN A History of SS Brassieres Osprey Publishing

Recently released by Osprey, is an interesting volume on brassieres of the SS between 1933 and 1945. The book is well researched and covers the development of the under garment from the date of Himmler's ReichFuherBefel No219, to the post war surplus that apparently lead to the use of SS uniforms in SMD sex trade. There is a full range of color plates and photos. Of particular interest was the geschutz version which had pistol holsters sewn onto the cups.....sizes 38DD and 9mm.

Highly recommended for those doing a study of lesser known uniform items of Nazi Germany.

Dak

* * *

The article above was stolen directly from the April 2012 issue of the Oklahoma Historical Modelers Society. Many thanks

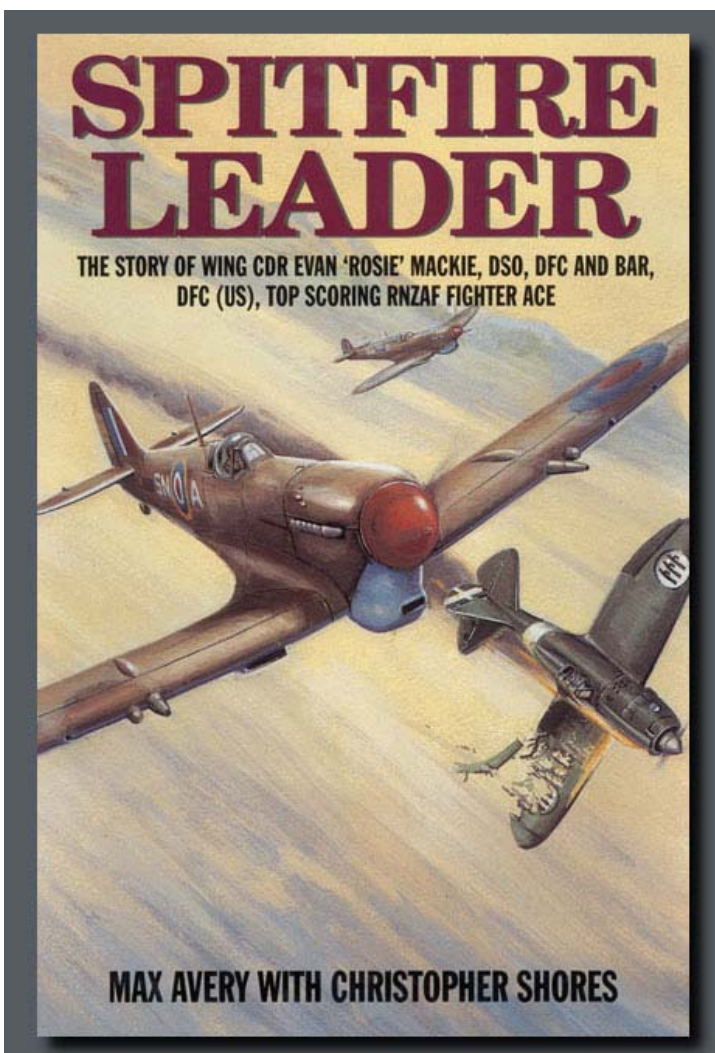

Book review: Ki-44 Tojo Aces of World War 2

Osprey aircraft of the Aces #100 Author: Nicholas Millman

Review by D.M. Knights IPMS/USA #17656
IPMS/Canada C6091

For me, the Osprey books can be a real hit or miss proposition. Some of them are great and some are not. Obviously with so many different authors, this variance in quality is understandable. Also, for the modeler, these books aren't exactly detailed modeling references on the aircraft covered. I find that that best of the Osprey series serve as inspiration for modeling and that is the case with this book.

The author, Mr. Nicholas Millman, has gained fame on the internet under the "pen name" Straggler, who publishes a website devoted to Japanese aviation with an emphasis on the colors and markings of those aircraft. If you are interested in Japanese WWII aircraft, the website is a must-have bookmark. (www.aviationofjapan.com).

The book begins with a brief description of the development of the Ki-44. The rest of the book lays out the different units in which the Ki-44 served and the pilots in those units who became aces flying the Ki-44 with those units. The subject of aces in regard to Japanese pilots is a thorny area, given that in many units credit for kills were not assigned to individual pilots, but rather to the unit as a whole. The authors

recognize this and seem to have done a good job of sifting thru the available records.

The Ki-44 began service, in pre-production form, in Burma at the outbreak of WWII. As the Ki-44 was developed, it served in every area of the Pacific theatre. Of particular interest to me was the coverage of the use of the Ki-44 in China, a subject that hasn't received much attention before now. The aircraft ended its career fighting as a home defense fighter against the B-29s and U.S carrier fighters which roamed over the Japanese homeland.

In addition to the excellent and very readable text, the book contains 32 color illustrations of various Ki-44s. One of my problems with the Osprey books is that you usually get only a left or right side illustration of an aircraft. That is true in this book, though there is at least one complete 3 view color illustration of one of the aircraft. There is also a 72nd scale multi view plan in the back of the book of a Ki-44 Hei.

I can recommend this book. It certainly inspired me to put a Ki-44 on my short list to build. I am especially interested in doing the black over bare metal Ki-44 that served in the East Indies in 1945. Hopefully, some day soon.

* * *

The Cranky Canuck

By Jim "The Finisher" Bates

Aircraft Pictorial 4: F4F Wildcat by Dana Bell

This is the fourth volume in a new series of aircraft books by Classic Warship Books of Tucson, Arizona. Authored by well-known modeler and researcher Dana Bell, they are similar in concept to the Squadron In Action series. After a two page introduction, text is limited to photo and drawing captions. The book is focused on details of the aircraft rather than operations and pilot stories. Unlike the In Action series, the photos are reproduced large, most often one or two to a page, and are pin sharp. I had not seen most of them before and all are of wartime vintage. While the book mainly focuses on US Navy and Marine Corps Wildcats there is a photo of an unfortunate Fleet Air Arm marked F4F-4B retained by the US for training purposes and a nice colour camouflage diagram of the British paint scheme. Other diagrams include Grumman general arrangement drawings, camouflage notes and diagrams, Squadron insignias, and the US Pacific Fleet geometric CVE markings. This is a great book for modelers looking for details and information about the F4F itself. Highly recommended.



The Canadair Argus: The Untold Story of Canada's Cold War Maritime Hunter by Major Cary Barker and Major Bert Campbell

The Canadair Argus plied the skies of Canada's East and West Coast during the Cold War and, outside of a few preserved airframes, is almost forgotten. Even in books about the RCAF, it gets, at best, mentioned for a few pages in chapters on Maritime Command. This 190-page hardcover book changes all that. It does what it says on the cover, it tells the story of the Argus from development to retirement. Everything is here; weapon's trials, stories of patrols, crew and maintenance tails, etc. I was fascinated by the Bullpup missile trials and the references to the use of the Argus during Cuban Missile crisis. The book is well illustrated with colour and black-and-white photos and nicely down aircraft paintings. A must for an RCAF fan of Maritime operations. ❄ ❄ ❄

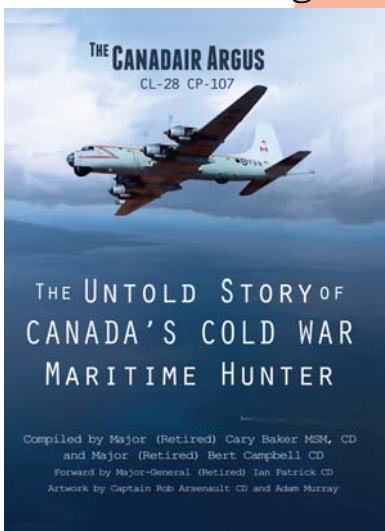

President's Page

By Stu Cox

MMCL Members,

Well, it's been a great 2012! We are wrapping up another successful year of **MMCL modeling success!** We have had the opportunity to participate and enjoy numerous Saturday Workshops, Club Meetings, Friday Night Fights, our own Invitational Show and numerous other regional Model Contests and Shows! I know we had attendees at most of the shows nearest to us in IPMS Region III, IV and V. Way to go to all who won contest awards this year and represented our club!

We had a great MMCL Invitational Show in May 2012, achieving our goal of making money for the club! Our 2012 paid member count is right at 50, and I expect us to exceed this number in 2013! Our finances are solid, thanks to annual dues, Workshop fee's, recycling proceeds, raffle proceeds and other donations. Thank you for your financial support of our club! We also continue to enjoy a great working relationship with the KYANA Automobile club, the owners of our building and meeting-place! Thanks go to KYANA for their support!

Speaking of our show, the next **MMCL Invitational show will be held on Saturday, May 18, 2013.**

We voted and aligned on a **KURSK 1943** theme to commemorate the 70 year anniversary of the epic WWII armor and air battle in Russia.

The **Commandant of our MMCL Afghanistan Sub-Chapter, Staff Sgt Bill Wise**, has returned to Louisville for the holidays and some club modeling time! MMCL proudly sponsored the **US Army 3rd ID Modelers** by donating supplies and kits. Bill put it all together in country and organized a number of Army

modelers to build and finish numerous kits across a variety of subjects! Way to go Bill, we appreciate your service to country and our club and are glad you are back in the USA safely!

We have **2013 Officer Elections** coming up this month at our meeting on the 20th. So far we have nominations for: **President: Stuart Cox, Vice-President: Terry Hill, Secretary: Dave Knights, Treasurer: Alex Restrepo and Member At Large (two nominations): Noel Walker and Randy Fuller.** Please plan to attend our meeting to show support for the club and cast your ballot for our elected officers for 2013!

Speaking of our **December Meeting on Thursday, December 20th**, we are once again planning to have a club dinner at **Logan's Roadhouse, at 5055 Shelbyville Road, directly across from Mall ST. Mathews.** Please plan to arrive at 6:00PM if you can. Some may arrive a little earlier for some fellowship! Members and spouses or other family members are welcome to attend! The cost for dinner is the responsibility of each member.

MMCL Leaders are looking forward to 2013 and we expect another great modeling year! Thanks to all of you members for being a valued part of the success of MMCL!

NORTHEAST OHIO CANOPY MASKING SERVICE

In December you send us two canopies and \$4.95, and we will send you one canopy back, and it might even be masked. Mail your canopy to NOCMS c/o Bates & Perry, 750 E. Washington St. Suite D-3, Medina, OH 44256.

Financial Report

By ALEX RESTREPO

Starting Cash Balance: \$4,508.11

Cash Receipts	Date	
Workshop Fee	11/13/2012	\$75.00
Workshop Fee	11/16/2012	\$68.00
Workshop Fee	11/19/2012	\$30.00
Monthly Raffel and Dues	11/26/2012	\$75.00
TOTAL RECEIPTS		\$248.00

Cash Or Debit Expenses:	Date	
Check # 7019 (E) KYANNA Rent	10/10/2012	(\$250.00)
TOTAL EXPENSES		(\$250.00)

NET Monthly Increase(Decrease): (\$2.00)

ENDING CASH BALANCE: Nov 2012 \$4,506.11



**2013
IPMS/Louisville
Invitational
Contest**



May 18, 2013
9 a.m. to 3:30 p.m.

**3821 Hunsinger Ln,
Louisville, KY
40220**

The Battle of Kursk

70th Anniversary

**Entry fee: \$10(\$8 for IPMS/USA members with card) which includes the first two models, \$1 per model after the second.
Juniors: (under 18) Flat \$5. General admission: \$2**

**Show Contact information:
Dr. Terry Hill
thill35434@aol.com
502-544-6383**

www.MMCL.org

HARMONY

Military Modelers of Louisville Membership Form 2012

Name: _____

Address: _____

City: _____ ST: _____ Zip: _____

Phone: _____ E-mail: _____

Birth Date: _____ Year Joined Club: _____

Would you like to receive your newsletter by e-mail? The e-mail version of Tactical Notes is in full color and is sent using the PDF format: Yes _____ No _____

Do you give MMCL permission to place your contact information on the club website: Yes _____ No _____

What are the advantages of membership to the Military Modelers Club of Louisville?

- Monthly meetings held on the third Thursday of the month at the club workshop located at 3821 Hunsinger Lane in Louisville KY.
- A monthly subscription to the official newsletter of the Military Modelers Club of Louisville, Tactical Notes. Tactical Notes contains kit reviews, editorials and modeling techniques.
- The Club Workshop. MMCL has its own club workshop. This is a great place for modelers to build kits and have a good time. The club provides tables, work lights and various tools. We also have quarterly all night model building sessions at this location.
- Quarterly in house model contests with prizes.
- Monthly model kit raffle.
- Annual club cookout.

All of this and more is included in your yearly \$10.00 membership (junior \$5.00) dues.

Please complete all information above and forward your check made out to MMCL for \$10.00 to:

Stu Cox, President
4100 WIMPOLE ROAD
LOUISVILLE, KY 40218
502-499-6618
COX40218@BELLSOUTH.NET

Please visit us on the web at WWW.MMCL.ORG

PD DT _____

Tactical Notes

**MMCL brings out
the BIG guns!**



**“Balki” Romanowski:
The Polish Sausage**

To contact MMCL:

President:
Stu "Bass" Cox
Email: Scox2010@gmail.com

Vice President:
Dr. Terry "Perch" Hill
Email: Thill35434@aol.com

Secretary:
David Knights
Email: LOULAW@AOL.COM

Member at Large:
Randy "Bluegill" Fuller
Email: Glusnffr@aol.com

Treasurer:
Alex "Catfish" Restrepo
Email: scox6618@bellsouth.net

Webmangler:
Mike "Carp" Nofsinger
Email: Mnofsinger@insightbb.com

"Tactical Notes" is the Newsletter of the Military Modelers Club of Louisville, Inc. We appreciate your taking the time to read this little newsletter. We'd appreciate it even more if you would write something. **Yes, I am talking to you!**

Cover Photos: Tom "Balki" Romanowski's
smackdown winning D-30 Russian field gun.



Editor's Note

Greetings: The February meeting was one of the best attended in years. There were approximately 35 members in attendance, with I believe 2 or 3 new members joining. Thanks too all those who came. The club really is making 2013 The Year of MMCL. (Trademark Pending)

Thanks to those who have been bringing items for the monthly raffle. Remember, you get a free raffle for every item you bring. Speaking of that, you also get a free raffle ticket for each article you get published in the newsletter. I really appreciate all the articles I've gotten recently. Thanks. Keep them coming. I continue to be proud that Tactical Notes contains almost all original content.

As you know we have a contest coming up. We are gathering donations for our world famous contest raffle. Please go thru your collection and see if you can come up with one or two kits or books or other modeling items to donate, the club would appreciate it.

Keep modeling and hope to see you at the April meeting.



You Asked For It.

Randy Fuller
MMCL/Eastern Bloc
Member-at-Large

“The Ends justify the Means”

As I sit here and try to ignore the voices in my head, I remember a comment from a fellow modeler a few weeks ago basically asking why I would spend my money on all of these aftermarket finishing supplies -- pigments, washes, filters -- when I could make the same thing for a fraction of the cost; like the old days? Well...Because I can? Because I need to? Because I want to? It's not a simple answer. When I started building kits as a child, I had none of these things. Kits were simpler; paint was simpler; I was slightly simpler. I can remember going to the local Woolworth store, picking up a Testors or Revell or Monogram kit for a few dollars, and just ripping the parts off the sprues and squeezing the tube of glue to quickly build as fast as I could. There was no dry fitting! I didn't care about seams! Paint was a 15¢ square bottle of Testors that I slapped on with a brush! But when it was done I was satisfied.

When I returned to the hobby years later, I began to see whole new side of it. I found out about Tamiya, Hasegawa, and Fujimi! I found \$2 a bottle ModelMaster in every FS color! I saw airbrushes! I saw early Eduard photoetch and Verlinden resin / PE

detail sets. I read FineScale Modeler and learned of all these techniques! I began experimenting to product more realistic results: Paint, black wash, drybrush. Wow! How amazing! I never knew! There was no going back! Now days, I spend a little more time and a lot more money on my projects. I have at least 5 sprue cutters at various angles to minimize damage and leave a smooth snip on the part. I can't imagine NOT putting some photoetch to dress up a kit. I have 7 airbrushes for crying out loud! PE, resin, washes, filters, pigments, oils, lacquers, acrylics, enamels, chipping solutions, slide molding, color modulation, pre-shading!! My point is, the hobby has changed and so have my skills, and my ability to be satisfied with the result.

There are still inexpensive kits designed for the novice, but if you are reading this, you are not in that category. You too take this hobby, no, art form seriously. You care about fit and finish. You may not always be completely happy with your final effort, but you still like to hear “That is a great looking model!” and “How did you do that?” from your fellow modelers. Because only a fellow modeler understands what you just did. The non-builder can never appreciate the engineering in a plastic model kit, or the painstaking efforts to paint the “reality of the paint”, or the meticulous and subtle weathering. So to get back to the question: why do I have so many after-market finishing products? Maybe it is the same reason I bought my first PE set, or the first resin conversion set, or that

airbrush, or when I realized Testors brushes were not the only brushes I could paint with. I am looking for any way to be better at my hobby. The reason I do use products like Mig Productions, and AK Interactive, and True-Earth, and Humbrol, Alclad, Vallejo, ModelMaster, etc, etc, etc... is because I am trying to better *my* work. Of course you can do it yourself, and I applaud every modeler who can scratch build intricate details, or paint figures with oils like Rembrandt, or take the time to mix up their own alchemy of solutions to weather and age their work. I used to make my own washes, and I wasn't satisfied, so I turned to other sources. And I am still trying to find the right mix for me.

And that's what this hobby is all about: finding your way to a satisfied result. I don't build to impress the judges, or my fellow modelers, or anyone else. You don't need the fanciest kit to win a contest, or use the latest weathering product, or any other aftermarket product. But I don't build to win a contest, I build just for me. If anyone else takes notice, well that's just a welcomed and appreciated bonus.

From the files of the Asphalt Institute... TWA L1049G Constellation N7102C

Founded in 1919, the Asphalt Institute is an association of international petroleum asphalt producers and affiliated businesses. Located to Lexington since 1989, the Institute maintains an archive which contains

a number of photographs of vintage aviation subjects. The AMK has been granted permission to use these photos in a series of newsletter articles.

Production of Lockheed's new Model 049 Constellation passenger airliner had barely begun when the US entered WWII. The Army Air Force was allocated all production of the Constellation for use as a military transport, assigning it the military designation C69. However, the new Wright R3350 engine that had been selected to power the aircraft was in the early stages of its development and was having some mechanical problems that needed to be addressed. Moreover, these engines were now also needed for the production of the Boeing B29 Superfortress bomber, which led to the suspension of C69 production after only fifteen had been delivered. To meet their needs for a long range transport aircraft, the USAAF focused instead on the Douglas C54 Skymaster, which had first flown almost a year earlier. It was also some 60 mph slower than the C69 and was unpressurized, but was powered by four more readily available and less troublesome Pratt and Whitney R2000 engines.

After the war, Lockheed resumed production of the Constellation, starting with the conversion of a number of unfinished C69s still on the production lines into airliners by adding more windows, a galley, improved ventilation and heating, and luxurious seating and other cabin amenities. A total of 74 civilian Model 049 airliners were built before production was superseded in 1946 in



favor of the improved L649 and L749 versions, which featured a newer and more reliable version of the R3350 engine, cabin air conditioning and an increased fuel capacity which added 1000 miles to its range. Twenty L649s and 119 L749s were produced before production ended in 1951. That same year, Lockheed stretched the design of the fuselage of the Constellation by more than eighteen feet, increasing the number of passengers that could be carried by one third. Over 500 smaller modifications were also made at the same time before production resumed, with the new version being known as the Model 1049.

Cargo versions of the Model 1049 with strengthened floors and large doors in the side of the fuselage were produced for the USAF as the C121 and for the US Navy as the R7V. In 1953, the more powerful Wright R3350 Turbo Compound engines became available

for civilian use and were incorporated into the Model 1049C and later versions. The Turbo Compound engine had four exhaustdriven power recovery turbines that were geared to the engine's crankshaft and added an additional 150 hp. The Model 1049 series was to become the most numerous of the Constellation family to be produced, with a total civilian production of 259, plus an additional 320 for the military.

The photographic archives of the Asphalt Institute contain this striking image of N7102C, which was the second 1049G built. The carefully composed photo was almost certainly produced by Lockheed's publicity department, and was probably taken in Burbank, California soon after the aircraft was built and before it had entered service. If nothing else, the well-dressed passengers that are boarding the aircraft contrast with current day norms.

The aircraft had logged about 36 hours of flight time before being acquired by Trans World Airlines on 16 March 1955. It was initially given the fleet name *Star of Windsor*, but it was renamed as *The United States* by the end of March. Following two weeks of crew training flights, the plane was used for a number of demonstration and publicity flights, beginning with a 9 hour 52 minute nonstop flight from New York to Dublin, Ireland on 02 April. In the next few days it was flown on a number of other airline routes around Europe, flying to Cairo, Rome, and Madrid, before returning to New York on 11 April.

It commenced scheduled transAtlantic passenger flights on 28 July 1955. The original name of *Star of Windsor* was restored and on 12 October 1955, it became the first TWA Model 1049G (known in TWA speak as the *Super G Constellation*) to visit Heathrow Airport in London, England. After accumulating a total of 23,407 hours of flight time (an average of more than seven hours per day), it was withdrawn from service in February 1964. It was quickly cannibalized for parts before being sold to Normandie Iron & Metals Co. of Goodyear, Arizona on 08 February 1965 and scrapped.

Another aircraft of some interest has been inadvertently captured in the background of the photograph. In addition to the triple tails of three other unidentified Connies in the background on the left side of the photo, there's a rare Martin 202 twin engine airliner wearing the livery of California Central Airlines visible on

the right side of the photo. Introduced into airline service in August 1947, it proved to have a weak main wing spar which necessitated complete rebuilding of the wing to replace it, and so only 47 were built before production ceased.

After beginning operations with war surplus DC3s in 1946, CCA had purchased five Martins from Northwest Airlines in September 1951. One of the first of the nofrills airlines, CCA offered flights between several California cities, with oneway fares as low as \$4.44. Although understandably quite popular with the passengers, these low fares ultimately proved to be too low for the airline to be sustainable, with CCA going bankrupt in February 1954. The 202 in the photo is N93045 *City of Burbank*. It was sold to Allegheny Airlines in March 1955, becoming N171A *The New Yorker*. Allegheny operated a small fleet of both the unpressurized Martin 202 and the improved Martin 404 until 1966. After its retirement, N171A was sold to Associated Products of America and stored at Wildwood, NJ until being scrapped in 1977.



Meet your MMCL members: Tom "Balki" Romanowski

Welcome to the second installment of a new feature here at Tactical Notes. We've had an influx of new members, so as a service to all our members, old and new, each month we will feature a photo and a little background on one of our members.

This month our club member spotlight turns on one of MMCL's own and catches him sneaking across the border illegally and attempting to blend into the vast throng of true American citizens that make up the membership of MMCL. Yes, I am talking about none other than Tom "Balki" Romanowski, or



as he was known during his brief (and we all know why it was brief and it wasn't the only thing that was brief) The Polish Sausage.

Tom hails from behind what used to be known as the "Iron Curtain" Namely Poland. Those of us who have known Tom for years have noted on several occasions that the Iron Curtain fell just after Tom left. Coincidence? I'll let you decide.

Tom claims he flew into the US on an airliner, but the crack Tactical

Notes investigative staff have discovered that he was actually smuggled in by Mexican "coyotes" in the back of a semi full of rotten fruit. Hey, that explains lingering smell!

Tom is a well known and much admired armor modeler in MMCL. In fact a photo of his recent smackdown-winnings D-30 graces this month's cover. However, it turns out that Tom's interests range well beyond modeling. He is apparently a fixture at Comic-con every year where he engages in what is known as Cosplay (Hey, look it up on the internet. I am not going to explain everything to you.

On the right is a photo of Tom in his signature Polish Winged Hussar costume. I am sure I'm not the only MMCL member that can't wait to see him wear it into a meeting. How about it, Tom?



The Cranky Canuck "Extra Large Edition."

By Jim Bates

Hellcats

While the Hellcat is best known for its stellar service with the US Navy during World War II, it was also an integral part of the Fleet Air Arm; especially with the British Pacific Fleet. May Canadian Navy pilots flew the Hellcat with the FAA, and a Canadian, Bill Atkinson, was the only FAA Hellcat Ace of the conflict.



Recently, two new 1/72 Hellcats have hit the market, one by Eduard and one by Cyber-Hobby. Both look wonderful in the box, but how do they compare?

Cyber-Hobby F6F-5N Hellcat Night Fighter

First out of the box was Cyber-Hobby's F6F-5N night fighter. (It has since been released as a F6F-3 as well.) Well molded in flash-free grey plastic, it has tons of detail, and all exterior panel lines are finely scribed. The wings are pre-split and can be assembled extended or folded. The ailerons and rudder are separate parts, but the elevators are molded with the horizontal stabs. The cockpit is well detailed with plastic parts for the floor, side panels, bulkhead, seat, control column, and a separate throttle and gunsight, along with photo etched metal seat belts. Oddly, stringers are molded on the inside of the fuselage halves. Of course, this is nice for the cockpit, but for the rest of the kit, nothing will be seen. The engine is also well detailed, as is the accessory compartment aft of the engine. Again, this is an odd move, as none of it can be seen, unless panels are cut from the fuselage. Other options include parts for retracted or extended landing gear, three different sets of wheels, and rockets, bombs, drop tanks, and radar pods as underwing stores. Two oddities are that the wing radar pod is comically small, while the pitot tube appears to be 1/48 scale. Two crystal clear canopies are provided, one with a separate sliding hood and windscreen and one molded as a one piece unit. Decals are provided for three US Navy Hellcats in overall Gloss Sea Blue.

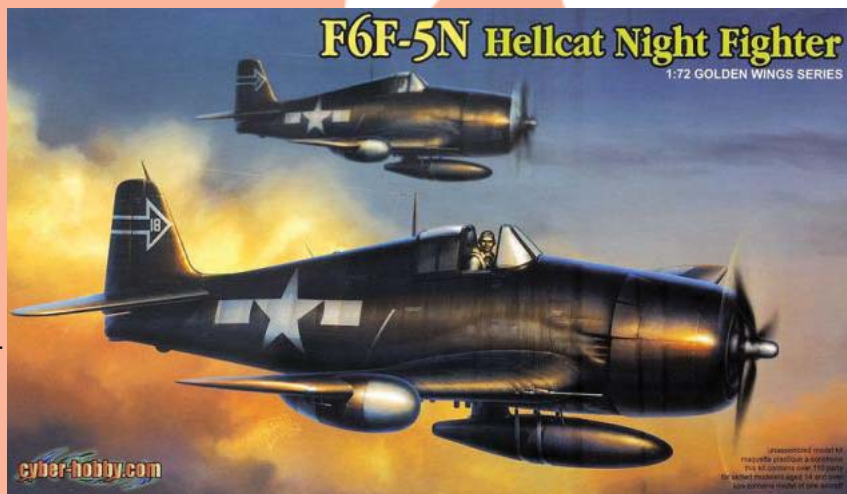

Hellcat Mk.I / Mk.II

ProfiPACK



Eduard Hellcat Family

Not long after the Cyber-Hobby kit hit the market, Eduard issued a family of Hellcats including a F6F-3, F6F-5, FAA Hellcats Mk. I and Mk. I, and a F6F-5N. The kits can be found in two versions: Weekend kits with only the plastic parts and one decal option and ProfiPaks with pre-painted photo-etch metal, masks, and multiple decal options.

I acquired both a Weekend F6F-3 and the Fleet Air Arm Hellcat dual combo. While these are simpler kits than the Cyber-Hobby example, the detail is still excellent. The cockpit, engine, and landing gear of the Weekend kit are on par with the Cyber-Hobby example, but if you have the fortitude to use the photo-etch metal, detail can be raised to another level. The exterior scribing is very fine, in fact, I have found it to be almost too fine. The lapped panels on the fuselage have to be seen to be believed. There are two wheel options provided, rockets are included in the F6F-5 kit, but sadly the bombs can only be built from a ProfiPack kit as the tail fins are only provided on the photo-etch metal fret. All flying surfaces are molded in the

neutral position and wings can only be built extended. The canopies are crystal clear and different canopies are provided for both the F6F-3 and F6F-5. In both cases the sliding portion and windscreen are separate. Interestingly, Eduard created two different wings sprues for the -5 and -3. The F6F-5 sprue has open mounting holes for the rocket stubs, so if you wish to build a rocket-less F6F-5 you will have some filling to do. Decal options depend upon the boxing, but I especially liked the choices in the FAA Hellcat boxing, even though they didn't include Bill Atkinson's aircraft.

So which is the better Hellcat?

Overall I like the Eduard kit better; it's simpler with less unnecessary detail. Accuracy appears better as well, as the canopy on the Cyber-hobby kit is slightly too wide, the Edward cowl looks more convincing, and Eduard have the pitot tube size correct along with the radome for the F6F-5N. Once you factor in price, I think Eduard is hands down the winner in this cat fight.

Don't Forget!

While the Italeri and Academy Hellcats have been superseded by the Eduard and Cyber-Hobby kits, the Hasegawa Hellcat is still a nice simple option if it can be found cheaply. It has raised panel lines and the detail cannot compare to the latest contenders, but it is an accurate simple kit, and especially well-tailored for the beginner.

President's Page

By Stu Cox

MMCL Members,

Welcome to March Modeling Madness, oh yeah, and that roundball stuff going on too. But don't let that deter you from indulging in your modeling madness. We have plenty of events, workshops and smackdowns for you to dive into and enjoy!

This week, on March 15 from 6pm till Midnight is our "MMCL Friday Night Fights" meeting and build session! We have the tables set for up to 30 modelers! So come on out to the KYANA building, and bring a friend if you would like. We all know we have friends who are closet scale model enthusiasts! So plan to come on out for an evening of fun and modeling fellowship.

Please see Facebook and our Website for all of the latest information on club sponsored contests and individual smackdowns coming up in 2013.

We two short months away from our MMCL Invitational Model Show & Contest, to be held at the KYANA building on Saturday, May 18th, 2013. We have most arrangements confirmed and we are in the final stages of preparation. What do we need? How can you serve the club best?

Two things, first, search your stash, be generous, and create a "raffle stash" that you are willing to part with in support of MMCL. We need all kinds of kits, books and accessories

to include in our awesome raffle in support of the show. We are well known for our large raffle selection and this is a big drawing card for attendees!

Second, we need your help with time in support of setup and execution the day of the show. We will not have a regular club meeting on Thursday, May 16th. However, we will be setting up the KYANA facility for the show. We did this last year and had all of the major setup complete in support of the vendor and contest areas before Saturday. Then we will need all kinds of help in support the day of the Show for Parking, traffic, Raffle, Contest Judging, Vendor assistance and overall cleanup after the show closes.

Let's have a great March, and we'll see you at the Workshop! President Stu(g)

February 2013 meeting with overflow crowd



Financial Report

By ALEX RESTREPO

Starting Cash Balance:		\$4,491.51
Cash Receipts	Date	Check
Workshop fees	2/11/2013	\$40.00
Workshop fees	2/19/2013	\$60.00
Renewal	2/22/2013	\$50.00
Raffle	2/22/2013	\$70.00
Workshop fees	2/26/2013	\$45.00
Total Cash Receipts		\$265.00
TOTAL RECEIPTS		\$265.00
Cash Or Debit Expenses:	Date	
Check # 7022 (E) KYANNA Rent	2/8/2013	(250.00)
Check #1045 Web Site	2/11/2013	(63.00)
Check 1046 Club Shirt order	2/17/2013	(626.00)
SRI contest gift cards	2/22/2013	(15.00)
Total Cash Expenses:		(\$954.00)
TOTAL EXPENSES		(\$954.00)
NET Monthly Increase(Decrease):		(\$689.00)
ENDING CASH BALANCE:	Feb 2013	\$3,802.51

2013
IPMS/Louisville
Invitational
Contest



May 18, 2013

9 a.m. to 3:30 p.m.

3821 Hunsinger Ln,
Louisville, KY
40220

The Battle of Kursk

70th Anniversary

Entry fee: \$10(\$8 for IPMS/USA members with card) which includes the first two models, \$1 per model after the second.
Juniors: (under 18) Flat \$5. General admission: \$2

Show Contact information:
Dr. Terry Hill
thill35434@aol.com
502-544-6383

www.MMCL.org

Military Modelers of Louisville Membership Form 2013

Name: _____

Address: _____

City: _____ ST: _____ Zip: _____

Phone: _____ E-mail: _____

Birth Date: _____ Year Joined Club: _____

Would you like to receive your newsletter by e-mail? The e-mail version of Tactical Notes is in full color and is sent using the PDF format: Yes _____ No _____

Do you give MMCL permission to place your contact information on the club website: Yes _____ No _____

What are the advantages of membership to the Military Modelers Club of Louisville?

- Monthly meetings held on the third Thursday of the month at the club workshop located at 3821 Hunsinger Lane in Louisville KY.
- A monthly subscription to the official newsletter of the Military Modelers Club of Louisville, Tactical Notes. Tactical Notes contains kit reviews, editorials and modeling techniques.
- The Club Workshop. MMCL has its own club workshop. This is a great place for modelers to build kits and have a good time. The club provides tables, work lights and various tools. We also have quarterly all night model building sessions at this location.
- Quarterly in house model contests with prizes.
- Monthly model kit raffle.
- Annual club cookout.

All of this and more is included in your yearly \$10.00 membership (junior \$5.00) dues.

Please complete all information above and forward your check made out to MMCL for \$10.00 to:

Stu Cox, President
4100 WIMPOLE ROAD
LOUISVILLE, KY 40218
502-499-6618
COX40218@BELLSOUTH.NET

Please visit us on the web at WWW.MMCL.ORG

PD DT _____

Tactical Notes

OH, CANADA!



GET YOUR NEW MMCL CLUB SHIRTS!!!!!!

Next Meeting: Thursday, April 18th, 2013 7PM

Final Show Prep! Bring some kits for the show raffle.

To contact MMCL:

President:
Stu "Toronto" Cox
Email: Scox2010@gmail.com

Vice President:
Dr. Terry "Montreal" Hill
Email: Thill35434@aol.com

Secretary:
David Knights
Email: LOULAW@AOL.COM

Member at Large:
Randy "Windsor" Fuller
Email: Glusnffr@aol.com

Treasurer:
Alex "Vancouver" Restrepo
Email: scox6618@bellsouth.net

Webmangler:
Mike "Ottawa" Nofsinger
Email: Mnofsinger@insightbb.com

"**Tactical Notes**" is the Newsletter of the Military Modelers Club of Louisville, Inc. We appreciate your taking the time to read this little newsletter. We'd appreciate it even more if you would write something. **Yes, I am talking to you!**

Cover Photos: Canadian Bling, Hosers!

In Loving
Memory,
Arthur "Yank"
Comstock,
WWII Navy
Veteran



Editor's Note

Well, here we are, less than two months from our invitational show. After the delay caused by family issues last month, this month's newsletter is back on track. As you can see, this month's issue has a theme. I won't tell you what it is. I'll let you guess, eh.

I want to thank IPMS/Canada and the editor of their BeaveRTales electronic newsletter for allowing me to reprint their recent article on converting a JN-4 into a Canadian Jenny. I hope you enjoy it as well. In addition, our Cranky Canuck is back, this time with an article celebrating the defacing of an American aircraft by ruthless Canadian hooligans!

Please write an article for our newsletter. I'd especially like some more armor articles. I've seen a lot of great armor building going on, but not much in the way of articles or reviews. I know I sound like a broken record, but if you'll get me an article or two I promise I'll shut up.

Finally, I want to thank everyone at MMCL for their kind thoughts on the recent passing of my father-in-law, Yank Comstock. Yank was a WWII navy vet and as good a father-in-law as anyone could want. He'll be missed.



How to catch a Canadian.

Magazine review: RT Vol. 34 No. 4 (Fall/Winter 2012)

By D. M. Knights IPMS/USA 17656,
IPMS/CANADA C6091

As you know if you have read my previous reviews, I am of the opinion that the two of the best modeling magazines out there today are the magazines produced by the national chapters of IPMS in the USA and Canada. The IPMS/Canada magazine is Random Thoughts (RT) and it is printed four times a year.

Like the IPMS/USA Journal, RT is wholly produced by volunteers and all of the content is from members. In this particular issue, there are a wide variety of modeling subjects presented. There is a wonderful article on a 1/144th airliner in Air Canada markings. The author finds a unique use for pearlescent nail polish. I would have never thought you could airbrush it.

There is an article on a 35th scale Valentine tank for the armor guys, a 32nd scale CF-18B, an article on a 72nd U-boat that was captured and used by the Canadians in World War II. Finally, there is a long article on building the Eagle space vehicle from the TV show Space:1999. (If you remember that show you are at least as old as I am).

One year memberships in IPMS/Canada are \$24 CAN and can be had by sending a check to IPMS/Canada, Box 626, Stn B, Ottawa, ON K1P 5P7, CANADA. I highly recommend joining. You won't regret it.

Canadian Cooking Corner

Poutine



Ingredients

Original recipe makes 4 servings
1 quart vegetable oil for frying
1 (10.25 ounce) can beef gravy
5 medium potatoes, cut into fries
2 cups cheese curds

Directions

1. Heat oil in a deep fryer or deep heavy skillet to 365 degrees F (185 degrees C). While the oil is heating, you can begin to warm your gravy.
2. Place the fries into the hot oil, and cook until light brown, about 5 minutes. Make the fries in batches if necessary to allow them room to move a little in the oil. Remove to a paper towel lined plate to drain.
3. Place the fries on a serving platter, and sprinkle the cheese over them. Ladle gravy over the fries and cheese, and serve immediately.



JN-4D to JN-4 Canuck

a good beginner's conversion

We present an expanded version of an article which originally appeared in IPMS Canada's RT back in 1971

The Curtiss JN-4 (Can), commonly called the JN-4 Canuck, was the first aircraft to go into mass production in Canada. Approx 1,210 were built by Canadian Aeroplanes Ltd. in Toronto. During WW I large numbers were used for military training both in Canada and the US. Many were subsequently sold as war surplus. Because of its availability and low price, the JN-4 (Can) became the preferred aircraft of many barnstormers in the decade after the war.

The JN-4 (Can) recorded more Canadian firsts than any other aircraft. For example, first mass-produced aircraft, first exported in large quantities, first use of ski undercarriage, first airmail, first aerial survey, and first flight across the Canadian Rockies.

Both the well-known Curtiss JN-4D Jenny and the JN-4 Canuck were developed from the earlier JN-3. However, they were developed independently from each other, and as a result there were several differences in the airframes.

The Canuck had ailerons on both the upper and lower wings, which were connected by a V-shaped strut, while the Jenny had ailerons on the upper wing only. On the Canuck the upper and lower wings had tips of similar shape, while on the Jenny the lower wing tips were rounded. The horizontal stabilizer on the Canuck was rounded while the Jenny's was angular. Finally, the Canuck had a round rudder while the Jenny's was taller and narrower. The drawings below will illustrate these differences. The JN-4 Canuck also used a joystick for control, whereas the Jenny had a control wheel.

To model a JN-4 Canuck in 1/48, you're limited to the only kit around – the ancient Lindberg JN-4D

Jenny, which though not common, can be found if you search. The conversion itself is relatively simple, and so if you've never attempted any kit bashing, this would make an ideal first subject.

Modifications to the wings requires the extension of the lower wing tips. The simplest method would be to cut the existing wing tip off at the first rib location, add a new correctly shaped tip made from sheet plastic, and file and sand in the new rib contours. Ailerons will have to be scribed. The upper and lower ailerons are connected by a thin V-shaped strut which can easily be made from plastic rod.

The horizontal stabilizer can be trimmed to the proper shape and smoothed out. A new rudder is also needed. This is best made from sheet plastic of suitable thickness.

In truth, the JN-4D's engine has a slight downward thrust and the wings have a slightly different stagger, but as well as being difficult to modify, these things are not that noticeable, so for a beginner's conversion, can be ignored.

The basic colour scheme for JN-4 Canucks was overall clear doped linen with a brownish green on the metal parts. Unlike on some artwork, the linen is actually quite a pale colour. The brownish green is probably like the wartime PC-10, and similar to an olive drab.

Colourful markings abound for the JN-4 Canuck. Fortunately a number of schemes are available on a set of decals produced by Lone Star Models. They also make a set of resin cockpit details for the JN-4. You can see them at www.lonestarmodels.com



Two photos showing the V-shaped aileron struts to advantage. On the left, in flight somewhere over Central Ontario, and on the right a museum display.



Aircraft C129 encourages viewers to “Buy a Bond”. The fuselage is emblazoned with a fleur-de-lis, and caricature of someone... John Bull, or Robert Borden perhaps?



JN-4 Canuck #C318 fitted with skis for operation on snow covered airfields.



The Lindberg JN-4 Jenny in one of its more recent boxings.

Curtiss JN-4 Can (Canuck)

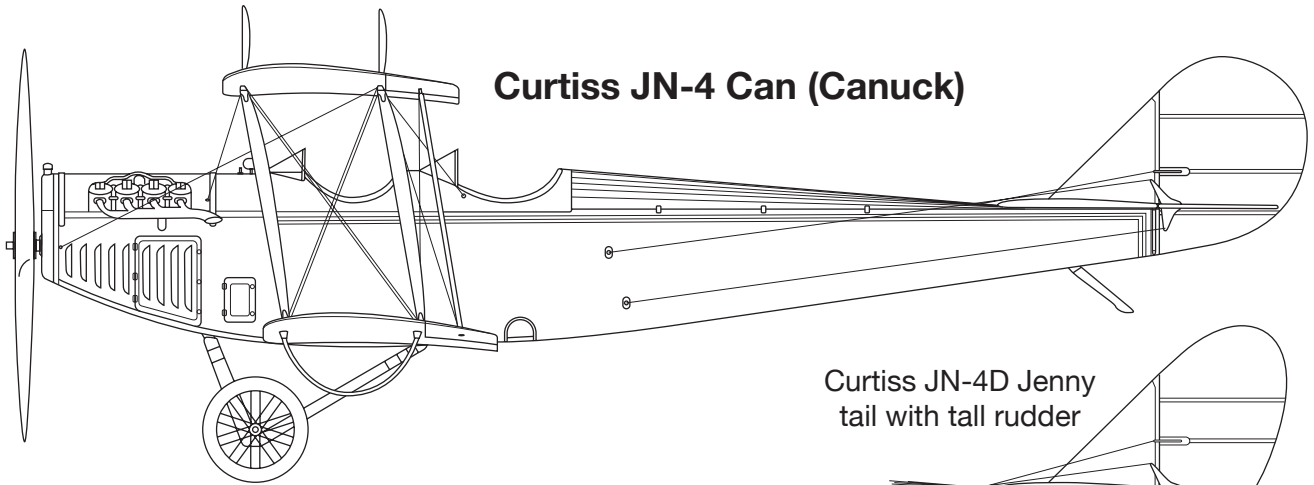

Curtiss JN-4D Jenny tail with tall rudder

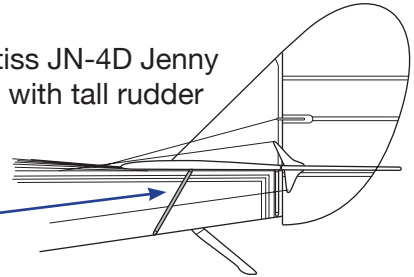

The JN-4 Can does not have this stabilizer strut.

JN-4D

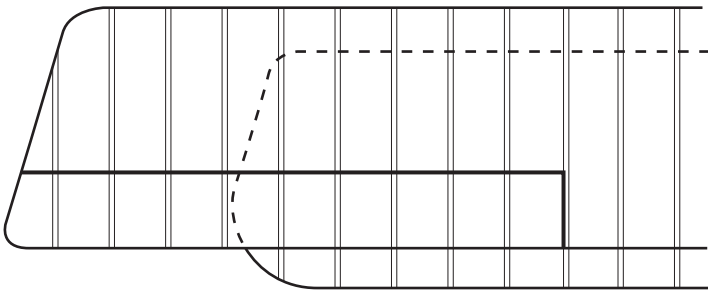

Rounded lower wingtip with no aileron

JN-4 Can

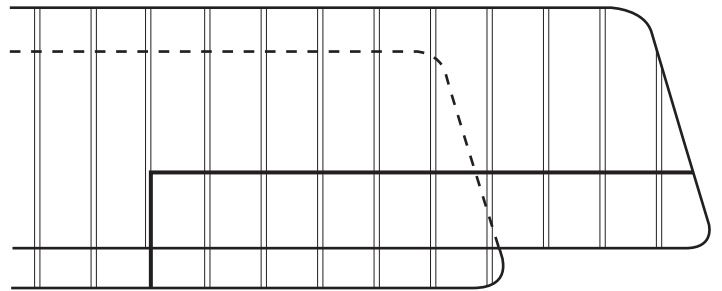

Angular lower wingtip with aileron

JN-4D

JN-4 Can

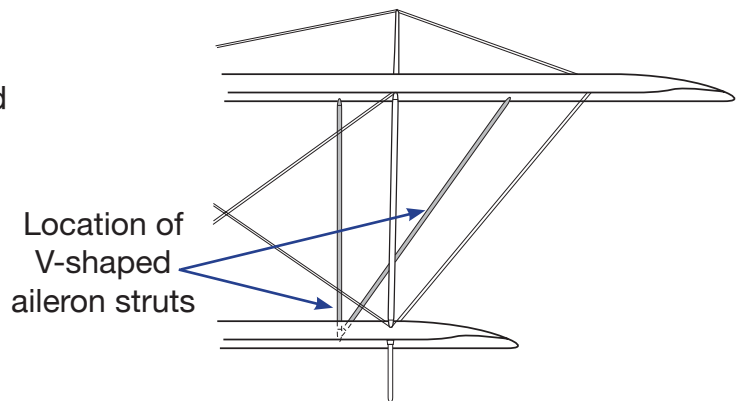
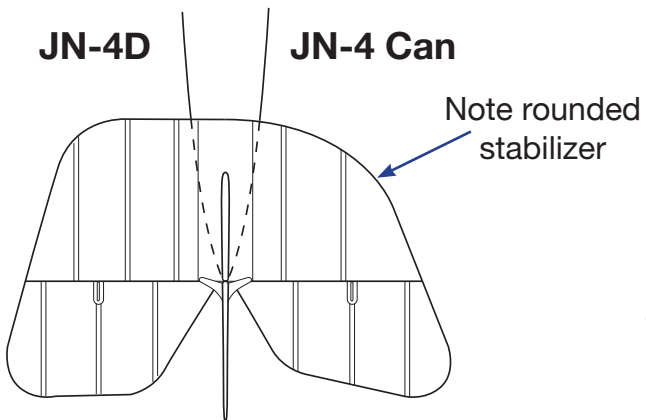



JN-4 Canuck, C696, Camp Mohawk, Deseronto ON. This was the personal aircraft of Capt Vernon Castle, killed in a crash Feb. 15, 1918.

Castle and his wife were the famous "Vernon & Irene Castle" dance team, about whom a movie was made starring Fred Astaire and Ginger Rogers.



JN-4 Canuck, #C368, City of Toronto



JN-4 Canuck #C300, of No. 81 Canadian Reserve Squadron, Camp Borden, Ontario, 1917.



JN-4 Canuck #C130 of No. 89 Canadian Reserve Squadron, CFC Armour Heights, Ontario, winter 1917. Note the different style exhaust pipes.



JN-4 Canuck, C705, No. 85 CTS at Benbrook Airfield, Texas, early 1918.

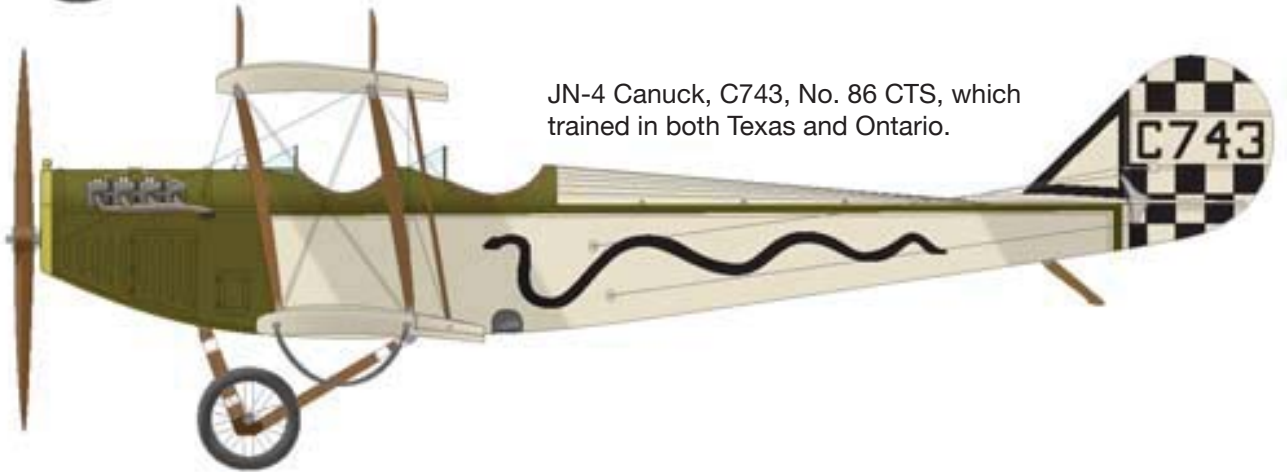

JN-4 Canuck, C743, No. 86 CTS, which trained in both Texas and Ontario.

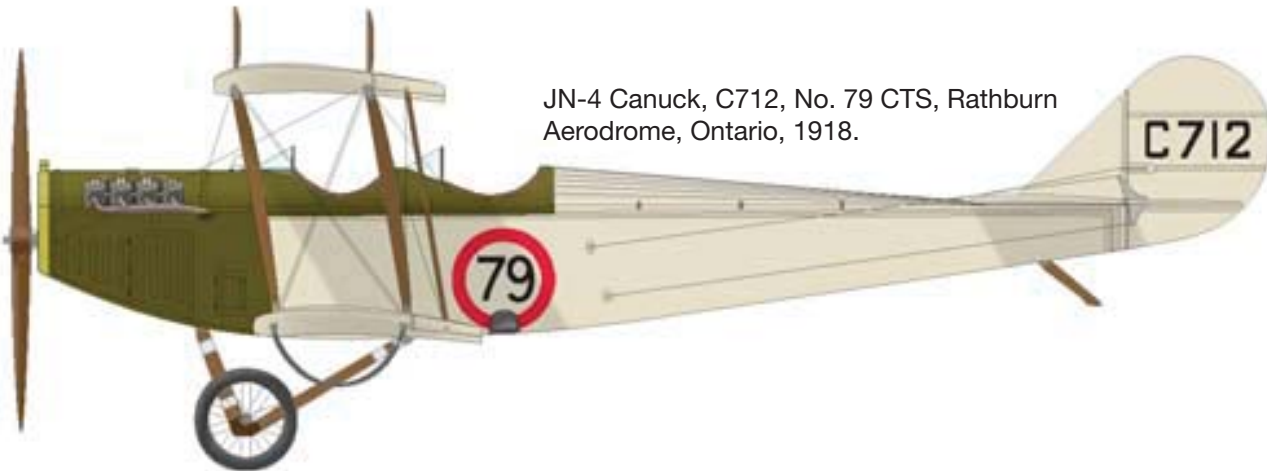

JN-4 Canuck, C712, No. 79 CTS, Rathburn Aerodrome, Ontario, 1918.



JN-4 Canuck #C1009 of No. 92 CTS, Armour Heights Aerodrome, Ontario, winter 1917-18

The Cranky Canuck

By Jim Bates

Royal Canadian Navy Skyraider On September 23, 1953, HMCS Magnificent, along with the Essex class carriers USS Bennington and USS Wasp were conducting training exercises as part of Exercise Mariner south of Greenland and Iceland. Operations had been launched despite concern that the potential existed for the weather to get dicey. Sadly, the meteorologists who predicted that the weather would hold were incorrect and a thick fog descended upon the carriers. The 40+ airborne aircraft had difficulty finding the carriers. With the closest landfall 450 miles away in Greenland, a plan was put into place that the aircraft would ditch near the submarine USS Redfin. Aircraft were en-route to the location of the submarine fearing the worst - a night ditching the north Atlantic - when the visibility increased and an order was given to "Head for the nearest carrier." Thankfully all aircraft were recovered, but the Maggie acquired an additional aircraft. Ensign James Elster from the USS Bennington flying Douglas Skyraider AD-4B BuNo 132354 determined that a landing on the short deck of the Magnificent was more advisable than attempting to make it back to the Bennington. While the pilots partied the night away, the Maggie ground crew took possession of the Skyraider and adorned it with maple leaves and "Maggie." Sadly, the Skyraider returned to the Bennington the next morning, but according to Stuart E. Soward's book "Hands to Flying Stations" the Skyraider spent the rest of its US Navy carrier carrying the Canadian leaves.



The Skyraider in Scale

The Douglas Skyraider has been well served in plastic with kits in all the majors scales, with the exception of 1/144. The best kit in 1/72 scale is the Hasegawa kit which was recently reissued as an AD-6 in VA-65 markings. In 1/48 scale the Tamiya Skyraider is excellent, though the 80's Monogram Skyraider, now issued by Revell, can still be made into a nice model. In 1/32 scale the large and well detailed Zoukei-Mura Skyraider has been released to positive reviews. In 1/144 scale, the best option is probably the pre-painted F-Toys gashapon Skyraider, which can be reworked into the RCN Skyraider. (Photos courtesy of the Canada Department of National Defence/Library and Archives of Canada.)



Lt. Elster w/ Cmndr of HCMS Magnificent

Meet your MMCL members: Jim “Canuck” Bates

This month, our profile is of a “honorary” MMCL member, our own “Cranky Canuck”, James C. Bates, Esq. Mr. Bates was born in Canada but claims to be a naturalized American citizen, though no one has seen any actual proof of this assertion. Mr. Bates also claims to be a lawyer licensed to practice law in the State of Ohio. Again, despite diligent research by our Tactical Notes staff, who spent a solid 15 minutes asking random people he ran into on the street, no one could confirm Mr. Bates’s legal credentials. Not to mention he hasn’t actually finished a model since 1992!

However, the crack Tactical Notes staff has uncovered a shocking and sinister plot to subvert the United State of America and turn it into nothing more than a vassal state of its large neighbor to the north, Canada, or as its commonly known here south of the border, Soviet Canuckistan. Our investigation reveals that Mr. Bates is a spy. He represents the cutting edge of an invasion force bent on weakening the American way of life as a precursor to an invasions by the crack Princess Patricia’s Royal Canadian Highland Fusiliers Sled Dog Army.

It turns out that having grown tired of living in sub-freezing temperatures and watching nothing but hockey and curling, the sneaky Canadians hatched a plot to weaken the good ole’ US of A as a prelude to invasion. As all MMCL members know, MMCL is a bulwark of American civilization and way of life, as exemplified by the massive spending on consumables such as model kits and the outrageously expensive and unnecessary photo-etch and resin accessories. As such MMCL was a prime target for attack. Without MMCL to stem the tide against Canadian politeness and smoked meat, America will be ripe for takeover.

So dear MMCL member, unless you wish to learn about icing, be mandated to work in “eh“ to every sentence, and be “forced” to drink quality beer, be on guard. Canadians are masters of disguise and can blend in easily with Americans. Mr. Bates could appear in one of several disguises. Keep an eye out for any of these people:



President's Page, Eh?

By Stu Cox

MARCH MADNESS is over!!!! The Louisville Cardinals have proven us Kentuckians proud! Now, back to the bench, all of you!!! I commit to do the same myself, as there are a number of scale

models for all to finish!

Please join us for our **monthly meeting on Thursday, April 18th** at MMCL Headquarters at the Kyana building on Hunsinger Lane. We have some finalization and details to discuss in preparation for our **Saturday, May 18th Invitational Model Show & Contest**. At this meeting we will feature a repeat presentation of our 2012 MMCL Model Show multi-media production to help get into the show spirit!

Please continue to scour your kit collections as MMCL needs your kit and accessory donations in support of our show Mega-Raffle! Your contributions are much appreciated and will help MMCL deliver a great raffle event! In addition, please talk with myself or Terry Hill about ways you can volunteer time and support during the preparation and execution of our show. Your club needs you!

Please join me in congratulating club secretary, **David Knights** as our **MMCL Tactical Notes Newsletter** has been named **"2012 IPMS Region IV Newsletter Of The Year"**. Ian Dow, our Region Director states: "It is a well done newsletter and provides good information. **Chapter of the Year** award goes to **Shenango Valley** for their tireless promotion of all things hobby and hobby related websites. **Website of the Year** award goes to **Kalamazoo** for their informational and informative website. Congratulations to the above mentioned clubs for doing all they have in helping to promote the hobby as a whole". Way to go to Dave for working hard each month to organize all the articles and information to publish a great newsletter representing our club. It's great for MMCL to be recognized as a region leader! Check out ALL of the Tactical Notes editions for the past two years on MMCL's website, under the "Tactical Notes" link!

Finally, **Randy Fuller** is now managing the contest/smackdown calendar as the MMCL "Member At Large". Here's what we have on the calendar so far (dates may be subject to change):

MAY: Aggressor Aircraft – 1:48th scale, and kit, any aggressor squadron aircraft. Aftermarket OK. Daniel Ledford called for it. Will be judged at May invitational contest.

JUNE: Mig-3 – Any MiG-3, 1:48th scale only, most are talking Classic Airframes kit. Aftermarket OK. The Uncle called this one. Judgment at June meeting.

SEPT: Old School Dragon/DML tank – Any older Dragon/DML 1:35th scale armor. Strictly out of the box – NO aftermarket PE or resin accessories. Bases allowed but will not count for entry judging. Any markings. Koko called this one. Due at Sept. meeting.

OCT: NATO/Warsaw pact MBT – Any kit, 1:35th scale main battle tank, post-1970 NATO or Warsaw pact markings. Sock called it. Now due at Oct. meeting.

One final bit of recognition. Thank you to **Travis Collard** for constructing an awesome MMCL Logo Plaque for adorning our meetings. You aren't going to believe this thing, it is huge! Travis will fill us all in on how he was able to turn our club logo JPG image into this huge carved wooden plaque during the April meeting.

So, come on out to our April meeting, as well as any Saturday Workshop that you can make. There is a lot of cool modeling going on, so we look forward to your involvement!



Financial Report

By ALEX RESTREPO

March 2013 PNC Bank

Starting Cash Balance: \$3,802.51

Cash Receipts	Date	
Workshop fees	3/4/2013	\$40.00
Workshop fees	3/12/2013	\$40.00
Workshop fees	3/18/2013	\$20.00
Workshop fees	3/22/2013	\$70.00
Workshop fees	3/25/2013	\$50.00
T shirts	3/25/2013	\$168.00
Total Cash Receipts		\$388.00

TOTAL RECEIPTS \$388.00

Cash Or Debit Expenses:	Date	
Check # 7023 (E) KYANNA Rent	3/8/2013	(250.00)
Check #1048 Name Badges (CT)	3/22/2013	(63.60)
Check #1049 Show Awards (CT)	3/28/2013	(478.49)
Total Cash Expenses:		(\$792.09)
TOTAL EXPENSES		(\$792.09)

NET Monthly Increase(Decrease): (\$404.09)

ENDING CASH BALANCE: Mar 2013 \$3,398.42

GET YOUR MMCL T-SHIRTS NOW!!!

T-shirts have been restocked and are available in MMCLBlue (white logo), Styrene Grey (black logo) and Modellers Maroon (white logo). Prices are \$10 for S-XL, \$11 for 2X, \$12 3X, and \$13 for 4X.

More photos from the Cranky Canuck

Fascinated Canadian Navy Crew who've never seen a real attack aircraft before

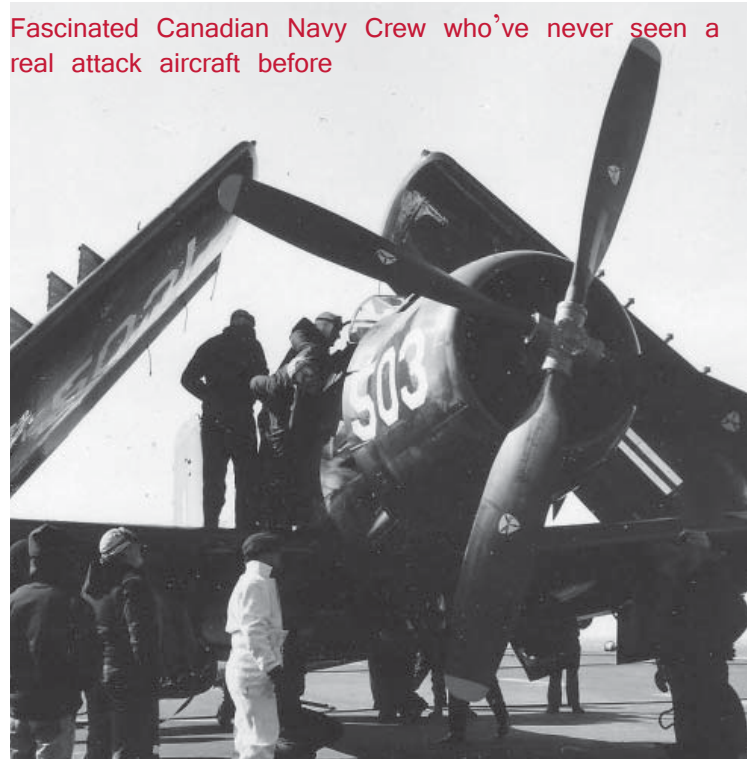

2013
IPMS/Louisville
Invitational
Contest



May 18, 2013

9 a.m. to 3:30 p.m.

3821 Hunsinger Ln,
Louisville, KY
40220

The Battle of Kursk

70th Anniversary

Entry fee: \$10(\$8 for IPMS/USA members with card) which includes the first two models, \$1 per model after the second.
Juniors: (under 18) Flat \$5. General admission: \$2

Show Contact information:
Dr. Terry Hill
thill35434@aol.com
502-544-6383

www.MMCL.org

Military Modelers of Louisville Membership Form 2013

Name: _____

Address: _____

City: _____ ST: _____ Zip: _____

Phone: _____ E-mail: _____

Birth Date: _____ Year Joined Club: _____

Would you like to receive your newsletter by e-mail? The e-mail version of Tactical Notes is in full color and is sent using the PDF format: Yes _____ No _____

Do you give MMCL permission to place your contact information on the club website: Yes _____ No _____

What are the advantages of membership to the Military Modelers Club of Louisville?

- Monthly meetings held on the third Thursday of the month at the club workshop located at 3821 Hunsinger Lane in Louisville KY.
- A monthly subscription to the official newsletter of the Military Modelers Club of Louisville, Tactical Notes. Tactical Notes contains kit reviews, editorials and modeling techniques.
- The Club Workshop. MMCL has its own club workshop. This is a great place for modelers to build kits and have a good time. The club provides tables, work lights and various tools. We also have quarterly all night model building sessions at this location.
- Quarterly in house model contests with prizes.
- Monthly model kit raffle.
- Annual club cookout.

All of this and more is included in your yearly \$10.00 membership (junior \$5.00) dues.

Please complete all information above and forward your check made out to MMCL for \$10.00 to:

Stu Cox, President
4100 WIMPOLE ROAD
LOUISVILLE, KY 40218
502-499-6618
COX40218@BELLSOUTH.NET

Please visit us on the web at WWW.MMCL.ORG

PD DT _____

May 2013

Tactical Notes



Its Showtime!

**Next meeting Thursday May 16th,
7p.m. Show setup**



To contact MMCL:

President:
Stu "Judy Garland" Cox
Email: Scox2010@gmail.com

Vice President:
Dr. Terry "Yul Brynner" Hill
Email: Thill35434@aol.com

Secretary:
David Knights
Email: LOULAW@AOL.COM

Member at Large:
Randy "Ethel Merman" Fuller
Email: Glusnffr@aol.com

Treasurer:
Alex "Hugh Jackman" Restrepo
Email: scox6618@bellsouth.net

Webmangler:
Mike "Liza Minnelli" Nofsinger
Email: Mnofsinger@insightbb.com

"Tactical Notes" is the Newsletter of the Military Modelers Club of Louisville, Inc. We appreciate your taking the time to read this little newsletter. We'd appreciate it even more if you would write something. **Yes, I am talking to you!**

Cover Photos: Tom "Balki" Romanowski's
smackdown winning D-30 Russian field gun.

Prologue (Editor's Note)

Greetings:

Hopefully this newsletter finds you fired up for our upcoming contest. I've been a bit busy with work and family and haven't been able to do as much as I've wanted to on the modeling front.

The last meeting was great. The new club shirts are very nice. Buy one or more to show your club support.

Remember to bring stuff to the meeting for the club raffle at the show. Our raffle is Legend--Wait for it-ary! We need to uphold that tradition.

Please pray for good weather on Saturday. Early reports are looking good. I'll need a number of members to volunteer to help judge out contest. Please volunteer.

Hope to see you at the meeting and at the show!!





Act I, Scene I You Asked For It. “Seeing Red... Over White”

Randy Fuller

MMCL/Eastern Bloc
Member-at-Large

No, I am not lamenting over the Cards win, sorry guys, nor am I longing for the glory days of my beloved Terrapins. This month I am really trying to put something practical in my rant. Painting white. Especially gloss white!

As I sit in my workshop today, working on the glossy white intakes of my F-16, I feel the apprehension building. How am I going to get that smooth, glossy, perfect white finish that always seems to elude me? In a world where acrylics are the new enamels, can I get the same results I expect from my trusty Humbrol, or Model Master, or the good ol’ Floquil white finishes of yore? I have to say, yes, but it is a specific “yes”. Tamiya. Thinned with the Tamiya Lacquer thinner, not the regular, sweet-smelling acrylic thinner. I have found my key to the successful glossy white. Now, I must confess that Tamiya is not my “go-to” paint. I have the critical basic colors, and I find I rarely use them, even when I’m building a Tamiya kit. Being a Vallejo convert for a few years I had expected to get a certain result when I used Foundation

White today. Alas, I did not. For me airbrushing this white for coverage gave me a spotty, uneven, and non-covering coat. I have had great success brushing their white paint, and I do like the Andrea “White” kit, with its multi-tinted shadows and highlights. But thinning and airbrushing for coverage is a different story.

Since I plan on weathering with the “new” enamel weathering products from Mig Productions and AK Interactive, I needed to basecoat with acrylic. So I pulled out my Tamiya X-2 white, thinned about 50:50 with the Tamiya Lacquer Thinner, and sprayed the best white coat I ever sprayed! It covered in one coat, flowed through my airbrush like silk, leveled quickly, and dried with a nearly flawless finish. I know – thinning an acrylic paint with a lacquer thinner!?! But comrades, it is true. This product somehow works to thin Tamiya acrylic paint to a magical consistency, covers extremely well, and dries to the desired finish. I may never go back to ordinary white paint.

Now I will caution you that this elixir is so specific that I have yet to find another acrylic paint this will work with – so don’t try thinning Vallejo or ModelMaster acrylics with this lacquer thinner (or any other for that matter) unless you want to be scraping jelly out of your airbrush. And don’t try thinning Tamiya paint with any standard lacquer thinner, or you will get the same result. I know. Let’s just not talk about that.

So I can recommend using this seemingly odd combination. I have gotten excellent results, which you may judge for yourself at the upcoming show – provided I actually get the bloody thing finished in time! Now maybe I'll do that 1:48 B-1 in anti-flash white, or see if the Cranky Canuck is up for a TSR-2 smackdown...

Act I,

Scene II

The story of Richard Starks and the B-17E s/n 41-9089 “Johnny Reb”

By Dennis Sparks, MMCL Eastern Bloc

In the summer of 1991, I was asked to help build a collection of models of aircraft that had been flown or serviced by Kentuckians during WWII, with the models to go on display in the terminal at Lexington's Blue Grass Airport to mark the 50th anniversary of the Japanese attack on Pearl Harbor.

A short time later, I was at the airport to see the Confederate Air Force's Boeing B17G “Sentimental Journey”. It was probably en route to a weekend airshow appearance and had stopped in Lexington mid-week and was offering tours through the aircraft's interior. While walking around and photographing the aeroplane I struck up a conversation with a 70-something year old man who

had brought his grandson to see the bomber.

His name was Richard Starks and he told me that he had flown a B-17 in the 97th Bomb Group of the US Eighth Air Force during WWII. He said that he and his crew had named their aircraft “Johnny Reb” and said that he was mildly surprised that he could still recall that the tail number of his aircraft was 19089.

When I told Mr. Starks about the modeling project and asked if I could build a model of “Johnny Reb” for inclusion in this display, he invited me to his house in nearby Midway, KY so he could provide more information and photos that might help me to produce an accurate model.

I'd also recently acquired a copy of Roger Freeman's book, “The Mighty Eighth”, and when I got home, I checked the book on the off chance that Mr. Starks was mentioned. It was a brief search, as there was an account appearing on page 16 in the first chapter. I discovered that Lt. Starks and his crew had flown “Johnny Reb” on the very first 8AF B-17 mission. The book also described their ordeal of only four days later.

When I visited him at his home a few days after our chance encounter, Mr. Starks provided a lot more detail about his rather brief combat career, including several items that I believe may not be in any of the history books.

“Johnny Reb” had started as Boeing's construction number 2561, one of the 512 B17Es that were built before

CONTINUED ON PAGE 6

Magazine review: Small Air Forces Observer Vol. 36 #4 (144)

By **D.M. Knights**, IPMS/USA 17656, IPMS/Canada C6091

The latest issue of SAFO is out. As always, I immediately read it cover to cover. While the production values are not up to current standards, the information in the magazine is always top quality. I end up reading and enjoying articles on subjects I did not think I would have any interest in.

In this issue, there is a really good article on aircraft impressed into service in wartime Holland. There is also an article on the development of Argentina's first jet fighter. I hadn't realized the Argentina was the 9th country to develop and fly its own jet aircraft. There is also an article on the use of the UH-1H by Lebanon as a bomber in 2008.

Subscriptions can be obtained for \$24 a year from Jim Sanders, SAFCH, 27965 Berwick Dr., Carmel, CA 93923.

in significant numbers. And therein is the challenge for the model builder striving for a complete collection, as not even all the major production types have been kitted in plastic. This article is the start of a series that will describe each aircraft, suggest kits where they exist, and offer conversion tips where appropriate. Just to keep things interesting, the articles will not appear in any particular order.

Here is the first aircraft - the North American A-27. The A-27 designation was given to 10 NA-69 light bombers. Originally purchased by Thailand, that were intercepted en-route and taken into U.S. Army Air Force service. They were left in their original camouflage (Dark Green/Dark Earth over natural metal undersides). U.S. insignia were painted over the Thai insignia and they were assigned to the 17th Pursuit Group in the Philippines. All were destroyed in

U.S. Army Attack Aircraft /A-27

by **Ron McCracken**

(Originally published in the March 2013 issue of the Sprue Examiner, the newsletter of the Austin Scale Modelers Society)

U.S. Air Corps/Army Air Force Attack aircraft are a subject largely ignored by the kit manufacturers, yet of considerable historical importance. The "A" designation was adopted for attack planes by the Army Air Corps in 1924 (previously it had been assigned to "ambulance" aircraft) and remained in continuous use until 1947.

At that time, the Air Force became a separate service, and the "A" designation was dropped. During those twenty-three years 44 designations were assigned (A-2 through A-45, A-1 having been used for an ambulance aircraft). 35 of these designations had at least one prototype built. However, only 14 types were ever produced

the opening days of WW II.

The A-27 was an AT-6 airframe adapted to the Wright R-1820 engine, (the same engine used in the similarly sized SBD Dauntless) with provisions for two cowling-mounted machine guns and a centerline bomb rack. Various references mention wing machine guns, but the few photos I've been able to locate show no evidence of these. My recommendation is to stick with fuselage-mounted guns only. There is no kit of the A-27 available, however there are some excellent AT-6 kits in both 1/48 and 1/72 scale that can be converted, without too much difficulty, into a passable representation of the A-27. The conversion is relatively simple; change the rear cockpit into a gunner's position, substitute a larger cowling to house an R-1820 engine in place of the R-1340 and add machine gun fairings to the upper nacelle area. The under wing bomb rack is a rather simple affair consisting of two Y-shaped combination pylon/sway braces under the fuselage centerline, one attached at the front main spar (the panel line just behind the main gear wells), the second 14 scale inches behind that.

The gunner's position modifications consisted of finding a .30 caliber machine gun from the spares box, and adding a gun mount half-ring cut from Evergreen plastic tube (5/32" diameter for 1/72nd). As for the engine cowling, I had on hand the spare set of cowlings from an



Academy 1/72nd B-17C/D kit, and one of these served the purpose. I merely had to add a bit of length to the cowling. For a 1/48th kit, again the easiest route is to adapt a B-17 cowling/engine. Basically, you need a cowling as long as the original AT-6 engine cowling, but of a larger diameter without the sloping upper profile line. The R-1820 engine used in the A-27 was 54 inches in diameter, so you need a cowling a bit larger than that. In 1/72 scale the

cowling outside diameter is $\frac{3}{4}$ inch. In 1/48th, it is 1 $\frac{1}{8}$ th inches. Also, the prominent air scoop on the port fuselage side of the AT-6 is gone, replaced by a rather boxy air scoop protruding from the top centerline of the cowling, at the rear edge, and curving up and over the cowling.

You will also need a three-blade



propeller. A tall radio antenna mast extends upward from the forward fuselage, offset slightly to starboard. A couple of pieces of sprue, carved down to the proper taper, provided the fairings for the two nose machine guns. You will have to carve out semi-circular troughs ahead of the fairings and add gun barrels. The canopy is the early AT-6 configuration. You'll probably need a different canopy as most kits represent the late AT-6G, which has

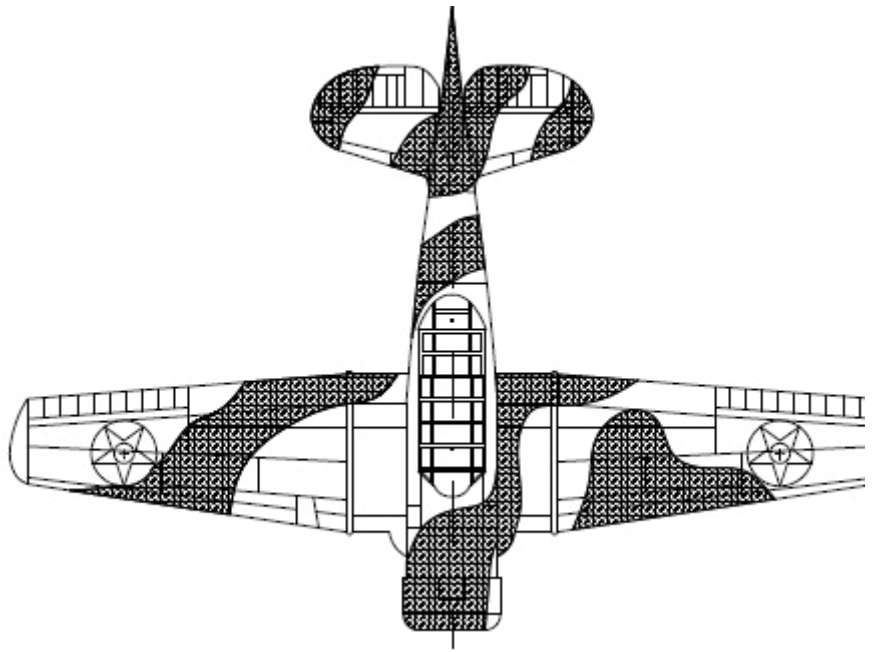

single pane side panels. The big challenge was figuring out an accurate camouflage pattern. Photo of these aircraft are, perhaps understandably, rare. But diligent searching of the web and my paper archives uncovered just enough views of these aircraft to reconstruct a complete camouflage pattern. Colors are RAF dark green and dark earth topsides, aluminum undersides. The darker areas of the drawings are dark green.

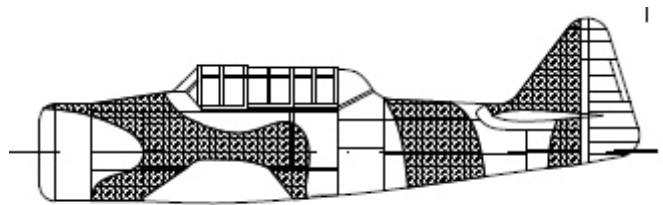
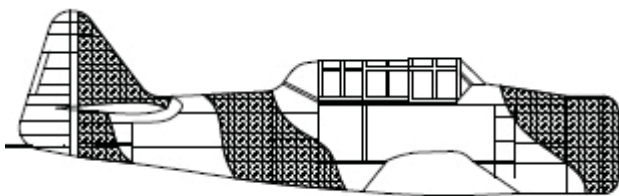

CONTINUED FROM PAGE 3

production shifted to the improved B17F version. It was accepted on USAAF inventory in April 1942 and was assigned to the 414th Bombardment Squadron of the 97th Bombardment Group, then in training in Florida.

Richard Starks and his crew were assigned as the regular crew for "Johnny Reb" and they flew training missions and anti-submarine patrols over the Gulf of Mexico until the end of May. One training mission that Mr. Starks mentioned was a simulated bombing mission from Sarasota,

Florida to the Yucatan Peninsula and back. Due to some miscalculation, the amount of fuel that was loaded into each plane allowed for almost no margin for error, which could have easily resulted in the ditching of a number of the new bombers into the Gulf. Starks blamed this mistake on the group's first commander, whom he described as a "damned drunk". By the end of May, the 97th BG had received orders to deploy to England and began making preparations, but a few days later a small detachment of aircraft including "Johnny Reb" were instead directed to fly to Geiger Field,

WA. The Japanese had just launched attacks against the Aleutian Islands of Alaska as a diversion for their attack on Midway Island in the Pacific.

But it was soon realized that the attack was not a prelude to a large scale invasion of the mainland, and the detachment quickly rejoined the rest of the 97th BG, which by now had arrived at Grenier Field in New Hampshire. They were to be the first to take part in Operation Bolero, an effort to ferry large numbers of combat aircraft to England via Greenland, Iceland and Scotland. They began departing for England in small groups on 23 June, and by 01 July, the first of the bombers had reached their new home at Polebrook, England.

During their trans-Atlantic journey, the bombers were also to provide navigation for accompanying flights of P38F Lightning fighter planes. The restored P38F that's now known as "Glacier Girl" was also a part of Bolero. It was a part of a formation of six Lightnings and two Fortresses that were forced to land on the Greenland icecap, and was dug out of the ice more than fifty years later.

During their first six weeks after arrival in England, the 97th BG continued their training, practicing their formation flying, gunnery, and navigation and radio procedures. With their training still lagging behind expectations, the original group commander was replaced by Col. Frank Armstrong in early August. Two weeks later, a small number of the crews were deemed proficient, allowing Eighth Bomber Command to schedule their first mission. And

so, on 17 August 1942, "Johnny Reb" was one of twelve B17s to bomb the railroad marshaling yards at Rouen, France. To help ensure their success, they were escorted to and from the target by successive flights from four squadrons of RAF Spitfires, while six other B17s flew a diversionary mission along the French coast before turning back.

As Col. Armstrong had not yet been fully checked out to fly the B17, he flew as the mission leader from the copilot's seat in the aircraft of the commanding officer of the Group's 340th BS. That squadron CO was Major Paul Tibbets, who was to command the 509th Composite Group and fly the B29 "Enola Gay" to Hiroshima three years later.

Brigadier General Ira Eaker, the head of VIII Bomber Command, also flew on that first mission. Mr. Starks told me that one of his recollections of this mission was watching Eaker's bald head sticking up out of the radio operator's hatch to look at the small formation around him. He added that he wondered what Eaker had thought about it, and if he could envision the massive striking force that the 8AF would later wield.

With additional crews now certified as being ready for combat, the 97th BG flew two more relatively uneventful missions with a small number of bombers during the next three days, while Starks and several of the other crews that had taken part in the first mission were off duty.

On 21 August, Starks and "Johnny Reb" were assigned their second mission, an attack on the Wilton

shipyards at Rotterdam. The group was once again to be escorted by several groups of Spitfires, which now included elements from the USAAF's newly operational 31st Fighter Group. But the bomber formation was 16 minutes late to their rendezvous point just off the Dutch coast, and the first group of Spitfires was already low on fuel and had begun returning to England. The mission was recalled and the bombers also turned and headed for home.

Soon afterward, the bombers were attacked by a formation of FW 190s from the Luftwaffe's JG1, and about five of the enemy fighters concentrated their attentions on "Johnny Reb", quickly knocking out the top turret and injuring the gunner. A 20mm shell hit the windscreen post on the right side of the aircraft and exploded, killing copilot Lt. Donald Walters. Metal and plastic shards severely injured Starks' right arm, and flash fire in the instrument panel burned his hands. Lt. Ewart Sconiers, who had "washed out" of pilot training before becoming a bombardier, left his position in the nose, moved Walters' body and took the copilot's seat. With two of the engines damaged and Starks only intermittently conscious, Sconiers flew "Johnny Reb" back to England, by which time Starks had roused sufficiently to make a safe landing at an RAF base at Horsham St. Faith.

Lt. Starks was returned to the US, where he slowly recovered the use of his right arm, but he was never cleared for return to combat. After the war, he briefly flew DC3s for

Eastern Air Lines before returning to Midway, KY to return to farming. Lt. Sconiers was the bombardier aboard the new B17F named "Johnny Reb, Jr." when the aircraft was shot down on 21 October 1942 and he became a guest of the Germans. Imprisoned at the Stalag Luft III POW camp, he slipped and fell on ice in January 1944, suffered a severe concussion and died a few days later.

As for the original "Johnny Reb", only three days after its second combat mission, all of the 97th BG's B-17Es were traded for the B17Fs of the newly arrived 92nd BG. Instead of immediately entering combat, the 92nd had been temporarily designated to serve as the 11th Combat Crew Replacement Center (CCRC) to train new crews, and so was given the older E models, with the 97th BG receiving the 92nd's new B17F's. The 97th BG was reassigned to the 12th AF in September 1942, but it continued to operate from England before moving to North Africa in late November. "Johnny Reb" served with the 11th CCRC at Bovington for some time and was possibly used on a few more combat missions before being passed on to the 96th BG at Grafton Underwood to serve as a utility aircraft. It survived the war and was scrapped in the UK in November 1945.

The model...

The model of "Johnny Reb" was built using Revell's 1/48th scale B17F1, which was the earliest production block of the F-series. Originally dating from the late 1970s, the kit has

been reissued a number of times, with decals to produce the “Memphis Belle” and “Knockout Dropper”. I used the clear plastic conversion parts offered by Koster Aero Enterprises for the blunter and more heavily framed nose cap, and used sandpaper to narrow the chord on the propeller blades to backdate them from the broader blades used on the later B17F and G versions.

One other minor visible difference between the B17E and early B-17F versions was that the face of the engine cowlings were slightly more tapered to provide the clearance needed to allow the broader bladed propellers to be feathered. I tried to replicate this by sanding the fronts of the cowlings so that the faces were a bit more squared off, but the effect is hardly noticeable. In retrospect, I probably should have tried to upgrade or replace the kit’s reasonably poor representations of the cowlings flaps, but either this didn’t occur to me or I couldn’t decide how to attempt it. Early B17Es had a remotely operated lower gun turret, but this had been replaced by the manned ball turret by the time 419089 was built. There were also a number of variations on the number and size of the small windows on the nose both as built and with field modifications, but at the time I didn’t have photos or documentation to be able to accurately portray the exact arrangement on “Johnny Reb”. The real “Johnny Reb” was one of about 35 of the E models that were being built to fill a British order, but they were instead taken into USAAF inventory after the US entered the

war. But by time this decision had been made, it had already been painted in an RAF-style camouflage pattern of dark green and dark earth colors on the upper surfaces and it was not repainted.

The color of the lower surfaces is less certain, with light gray, light blue and the odd light green color known as “Sky” all mentioned as possibilities. Twenty-plus years ago, I opted for “Sky”, but would probably use light gray if I were to build another one now, albeit with a rather badly strained line of reasoning for my choice. This same color conundrum applies to the paint scheme that Curtiss used on the 100 examples of the Hawk 81 that became the Flying Tigers in China, with later evidence lending some credence to the choice of light gray.

The 97th BG was the first 8AF heavy bomber group, predating the use of any squadron or group coding. The last two digits of the serial number were used to identify the aircraft



and were painted on each side of the nose. The kit’s decals were used for the national insignia, and aftermarket

dry transfers were used for the numbers on the nose and tail. Like several other aircraft in the group, the name was painted on each side of the nose in small yellow block letters with a black shadow added. I lightly drew the name on the model with a mechanical pencil, and then hand painted over that with smallish (and pointy!) brush, a task that I would find somewhat more difficult today.

Epilogue (President's Page)

By Stu Cox

I'll keep it short and to the point! Come ye all to the MMCL Workshop this Thursday and Saturday! We need your help to set up and execute our **MMCL IPMS Invitational Show** this upcoming weekend (Saturday, May 18)!

Our preparation and planning has paid off and the only final preparations to make are the final set up of the contest and vendor areas this upcoming Thursday evening. We are having a club meeting, but are focusing our efforts on the facility setup and layout. We will be moving tables, adjusting leg height, adding table covers and placing all the signage out during this process.

On Friday, whoever is available will be meeting at 1:00PM at the KYANA facility to set up our outside tent covering.

On Saturday, we will need "all hands on deck" at 7am to help ensure the facility is ready to go for the vendors to get set up. We'll need to

tidy up and have everything ready to go in the raffle area as well.

Modelers / entrants will arrive by 9am and will start to place model entries on the tables.

Judging begins promptly at noon. Let me be direct here, WE NEED ALL AVAILABLE MMCL MEMBERS TO HELP WITH THE JUDGING! Don't worry, we will NOT allow our members to judge a category they have entered in. But, we do encourage judging of other categories. We will set up teams to ensure there is plenty of feedback and help.

Let's hope for a great weather day Saturday! The KYANA automobile club will be on hand to display their restored cars on the front lawn. We have "Wills Grill" back this year to provide some great BBQ for lunch! MMCL Members will receive a \$1 discount on all food purchases.

Be there this Thursday, May 16th at 7:00pm or earlier to help us with final preparations. Then, we'll see you on Saturday for the MMCL IPMS Invitational!

Thanks to all, we'll see you at the show!

President Stu(g)

Credits (Financial Report)

By ALEX RESTREPO

April 2013

Starting Cash Balance: \$3,398.42

Cash Receipts	Date	
Workshop fees	4/1/2013	\$95.00
Workshop fees	4/7/2013	\$35.00
Raffle	4/19/2013	\$47.00
Recycle	4/19/2013	\$42.03
Show awards	4/19/2013	\$102.00
T shirts	4/1/2013	\$30.00
Dues	4/7/2013	\$10.00
T shirts	4/19/2013	\$62.00
Dues	4/19/2013	\$10.00
Workshop fees	4/22/2013	\$55.00
TOTAL RECEIPTS		\$488.03

Cash Or Debit Expenses:	Date	
Check # 7024 (E) KYANNA Rent	4/8/2013	(250.00)
Cash Shop lights for May Show	4/11/2013	(26.00)
Check # 1050 Big Top tents	4/16/2013	(250.00)
Check # 1051 Maroon shirt re-order	4/25/2013	(174.00)
Total Cash Expenses:		(\$700.00)

TOTAL EXPENSES (\$700.00)

NET Monthly Increase(Decrease): (\$211.97)

ENDING CASH BALANCE: April 2013 \$3,186.45

2013
IPMS/Louisville
Invitational
Contest



May 18, 2013

9 a.m. to 3:30 p.m.

3821 Hunsinger Ln,
Louisville, KY
40220

The Battle of Kursk

70th Anniversary

Entry fee: \$10(\$8 for IPMS/USA members with card) which includes the first two models, \$1 per model after the second.
Juniors: (under 18) Flat \$5. General admission: \$2

Show Contact information:
Dr. Terry Hill
thill35434@aol.com
502-544-6383

www.MMCL.org

Military Modelers of Louisville Membership Form 2013

Name: _____

Address: _____

City: _____ ST: _____ Zip: _____

Phone: _____ E-mail: _____

Birth Date: _____ Year Joined Club: _____

Would you like to receive your newsletter by e-mail? The e-mail version of Tactical Notes is in full color and is sent using the PDF format: Yes _____ No _____

Do you give MMCL permission to place your contact information on the club website: Yes _____ No _____

What are the advantages of membership to the Military Modelers Club of Louisville?

- Monthly meetings held on the third Thursday of the month at the club workshop located at 3821 Hunsinger Lane in Louisville KY.
- A monthly subscription to the official newsletter of the Military Modelers Club of Louisville, Tactical Notes. Tactical Notes contains kit reviews, editorials and modeling techniques.
- The Club Workshop. MMCL has its own club workshop. This is a great place for modelers to build kits and have a good time. The club provides tables, work lights and various tools. We also have quarterly all night model building sessions at this location.
- Quarterly in house model contests with prizes.
- Monthly model kit raffle.
- Annual club cookout.

All of this and more is included in your yearly \$10.00 membership (junior \$5.00) dues.

Please complete all information above and forward your check made out to MMCL for \$10.00 to:

Stu Cox, President
4100 WIMPOLE ROAD
LOUISVILLE, KY 40218
502-499-6618
COX40218@BELLSOUTH.NET

Please visit us on the web at WWW.MMCL.ORG

PD DT _____

Tactical Notes



MMCL
brings
out the
big
guns!



More MMCL Show photos

President Stu rocks the house!

Next meeting: Thursday, July 18th, 7p.m. MiG-3 Smackdown

To contact MMCL:

President:
Stu "Oppenheimer" Cox
Email: Scox2010@gmail.com

Vice President:
Dr. Terry "Teller" Hill
Email: Thill35434@aol.com

Secretary:
David Knights
Email: LOULAW@AOL.COM

Member at Large:
Randy "Fermi" Fuller
Email: Glusnffr@aol.com

Treasurer:
Alex "Lawrence" Restrepo
Email: scox6618@bellsouth.net

Webmangler:
Mike "Feynman" Nofsinger
Email: Mnofsinger@insightbb.com

"Tactical Notes" is the Newsletter of the Military Modelers Club of Louisville, Inc. We appreciate your taking the time to read this little newsletter. We'd appreciate it even more if you would write something. **Yes, I am talking to you!**

Cover Photos: Dennis O'Connor's Atomic Cannon
Photo composite by Randy Fuller



Russ Fischer's Ford GT 40

Editor's Note

This issue contains an article that I've been waiting to get published. Doc's Atomic Cannon has been a real odyssey for him. Those who have seen him work on it at the shop couldn't help but be impressed. I made him promise early on that he'd do an article for me when it was done. Being a man of his word, he has delivered and I am very happy to present it to you in this issue.

I missed our Friday Night Fight meeting. Like many folks, summer can be tough for making meetings. I have to say I was impressed by the photos posted on Facebook showing all the people who made the meeting. Let's keep it on a roll and have a great turnout for our July meeting.

I've put a few more photos from the recent show in this issue. I'll keep putting these in coming issues so anyone who didn't attend and hasn't been able to view the photos online will get to see some of the great work that was on display at the show.

Finally, again I want to express my thanks to everyone who has written for the newsletter. Your hard work has allowed us to be the Region 4 newsletter of the year two years in a row. It has also allowed me to lay out issues a month or two in advance as well as work on some special issues. More on that in the near future.



You asked for it.

Randy Fuller
MMCL/Eastern Bloc
Member-at-Large

My Secrets to Model Photography

May 18th provided me a target rich environment! I am pleased that MMCL trusted me to document this year's Invitational show again. As many of you have been admiring my photographs of some truly stunning models, I will share with you some of my tips. Now, I realize most people use the cameras on their smartphones, but as a die-hard SLR guy, I still think the best come from a more conventional camera. These tips are more about the technique rather than the equipment.

For better close-ups, step back.

When photographing miniatures, we want to capture the smallest of details, but moving in tight on a model will limit how much of it will actually be in focus. This is a limitation of the camera known as depth of field. To get more of the model in focus, step back a few feet and use a zoom lens. You'll have greater depth of field and can always digitally zoom in tighter for the smaller details.

Add the light, lose the shadow.

When you look at a model in any light, you see an evenly exposed scene, but when you capture that with a camera, it's a different story. Film and digital

media need much more light than the human eye, so a flash (strobe) is an easy way to add a lot of intense, bright, white light to illuminate a scene. The problem is a lot of focused light creates really bright and really dark areas. To cut the harsh shadows, use a diffuser on the flash. You can by inexpensive plastic diffusers that fit right over your camera's built in flash, or you can improvise. Use frosted Scotch tape right over the flash lens to soften the light. A piece of thin tissue paper held in place will also cut the shadows. Be sure to try a couple of different settings to make sure you know the correct exposure to use.

Unless you have wings, loose the bird's-eye view.

Almost every shot you see of a model is above it looking down. While this give the viewer a comprehensive shot of the overall model, it is rarely on seen in nature. Look at photos of real objects, and it's on eye level or maybe even looking up. Try to match these angles when photographing models. Get down and look at the model form a lower angle. A dynamic angle will add some more realism to your shots as well as being visibly interesting.

Don't sweat the scale color; learn the color of the light.

Green isn't green if the light you're photographing with is blue. Color balance is the most overlooked and least understood aspect of photography. It is even important in black and white photography! Our eyes are remarkably adaptable to various light sources, but our cameras

not-so-much. A flash or strobe will give you the next best thing to sunlight, but artificial light will have a variety of color shifts. Use the auto white balance on your camera, but it's best to retouch in post processing for the most accurate color balance. Most photo editing software programs have a white-balance adjustment. If you have a portion of the photo that has white in it, you can usually just click the icon and select the white area for an automatic adjustment.



Lee Fogel's 1/48th scale He-51 from the 2013 MMCL show.

More is More

Digital memory is cheap. Don't skimp on the shots! If you take a few to several different photos – different angles, exposures, etc... -- you may find that one perfect shot. Photographers today take dozens to hundreds to thousands of shots on a job. This assures you WILL capture "the one"! Click away!

Chris Toops' winter schemed PzIII at the MMCL 2013 show



The Cranky Canuck "I'm back edition."

By Jim Bates

The Seafire Mk. XV

The Griffon-engined Seafire Mk. XV was the Royal Canadian Navy's introduction to fighter aircraft in the early post war years. Thirty five were taken on strength by the RCAF in 1946. They were transferred to the RCN in 1947, even though they had been operated by the Navy for the previous year. The Seafires were flown off the HMCS Warrior by 803 and 883 Squadrons until being replaced by Sea Furies in 1948; after which they were operated for training and exhibition purposes until late 1949. The remaining aircraft at that time were relegated to use as ground based training aids. Two former Royal Canadian Navy Seafires survive today, one in a Museum in Alberta and an airworthy example with a private owner in the United States.



The Seafire Mk. XV in 1/72 Scale

As far as I know, the first complete Seafire Mk. XV kit was issued by Ventura Hobby Products of New Zealand in the 1980s. This is a very early example of a short run injection molded plastic kit with thick sprue gates, extensive flash, brittle plastic, and flow lines inside the parts that resemble tree roots. It had some metal parts, vacuform canopies, and a nice decal sheet that included a Royal Canadian Navy example. I'm sure a very experience modeler could turn out a nice model from this kit, but for the rest of us mere mortals, it really isn't worth considering. The plastic in my example was so brittle it was impossible to remove the parts from the sprues without them shattering.

Next up to bat was Czech Master Resin with two different Seafires; an "A Frame" tail hook and a "stinger" tail hook example. My kit is the "stinger" tail hook version and it contains very nice decals for two RCN Seafires; an Extra Dark Sea Gray and Sky aircraft from 803 Squadron (Which actually is Extra Dark Sea Gray and Dark Slate Gray over Sky), and a two tone gray example from 883 Squadron. The CMR kits are molded in two types of resin; the main fuselage halves and the one piece wing are in a light cream coloured resin, while the detail parts are in a darker shade. Two vacuform canopies are also included. The detail parts are well molded and the detail is good. The cock-

pit has some sidewall detail, a seat, a “floor,” a control column, an instrument panel, rear armor, and rudder pedals. Not spectacular, but good enough for the scale. The fuselage and wings have well done engraved scribing, but my example has one or two unfortunately located air bubbles. At the time it was issued, it was by far the best Seafire on the market, but being a resin kit, it will take a little extra work to construct and some experience with CA glue. (A few years after the release of the kit, CMR also issued a resin wing fold conversion that included decals for a different two tone gray RCN example from 883 Squadron. I have not seen this set, so I cannot comment further.)

The most recent contender in the 1/72 Seafire sweepstakes is the Sword kit. Once again issued in two versions, my kit is the “late” issue which includes the stinger arrest hook, but no RCN decals. (The “early” issue appears to include a second sprue with additional fuselage halves to build an “A Frame” hooked Seafire. It also appear to contain decals for an 883 Squadron Seafire in the two tone gray scheme.) The kit contains one sprue of grayish-blue plastic parts, an injection molded canopy, and four resin parts. The plastic parts are beautiful with only a

small amount of flash. While ostensibly short run technology - for example there are no locating pins - they look as good as many kits from major manufactures. About the only flaw on my example was that the spade grip on the control column was not fully molded. There is some nice sidewall detail in the cockpit, along with 11 plastic parts. Cockpit detail is a notch or two above the CMR kit and is excellent for the scale. Two wheel options are included, three spoke and four spoke wheels, but the propeller and spinner are six pieces and could be slightly tricky to assemble. Exterior scribing is

engraved and quite petite and fine. The major parts of the Sword and CMR kits line up well and both appear quite accurate. My only complaint with the kit is that there is an odd raised



area under the wing where the shell injection shoots should be for the cannons. I’m not sure what Sword did here, maybe basing their kit off a preserved example that has the area plugged? There are some large pin injection towers on the inside surfaces of the wing which will need to be removed, but doing so will be easy with some sprue cutters. Three options are provided on the decal sheet, all from the Fleet Air Arm. This looks like an excellent kit, and the best op-

tion for a RCN Seafire in 1/72 scale, but care will still need to be taken with assembly.

Both the Sword Seafire and the CMR kit and conversion can be purchased from West Coast Hobbys of British Columbia (<http://www.westcoasthobbys.com/>) and alternate RCN Seafire decals can be found on Belcher Bits Sheet BD17 (<http://www.belcherbits.com>).

New U.S. Navy Decal

Starfighter Decals 72-138 Colorful Dauntless

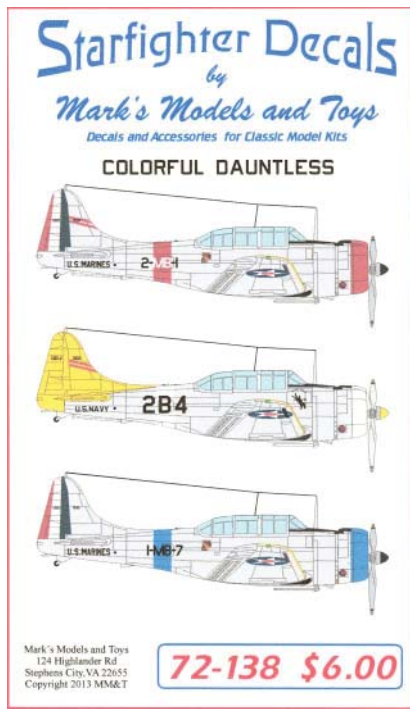

less: Recently release by Starfighter decals is this very colorful sheet with options for two USMC SBD-1 and one U.S. Navy SBD-2 “Yellow Wings” Dauntlesses. Beautifully printed, you get all the individual markings for each

subject but only one set of national insignia. A small color placement guide is included. The two USMC options will require a SBD-1 conversion set that Starfighter hopes to release later in the year For \$6 this sheet is excellent value for the money and highly recommend if you want add some color to your

model shelf. (<http://www.starfighter-decals.com>)

fündekals 1/72 Lt(jg). Daniel A. Carmichael’s VBF-12 F6F-5 Hellcat: fündekals is a new manufacturer that has decided to take a new approach to decal production. They are doing one subject sheets with no printed instructions in all major scales. In this case, the single option is for Lt. Charmichael’s Hellcat. The sheet has serials, codes, and kills markings but you will need to source your national insignia from the kit and paint your own white stripes on the tail. No muss, no fuss. Everything is perfectly printed and you are directed to www.fundekals.com to download an instruction sheet for decal placement and scheme information. The PDF download is very well done with a three view drawing, measurements to paint the aforesaid white stripes, and historical photos of the subject aircraft. I really like this idea of affordable small sheets with one option. Rumor has it that some additional U.S. Navy subjects are in the offing. (<http://www.fundekals.com>)



The M65 Atomic Cannon Scale Model: A Build That Took Over 50 Years to Complete

By Dennis “Doc” O’Connor

The following documents a journey that began in Germany around 1958 and pretty much spans a lifetime. In the end, I haven’t decided whether to smile and say that perseverance triumphed over adversity, or to sigh and grumble that it would have better to have left well enough alone. This then is the story of tackling the Revell reissue of the U.S. Army Gun, Heavy, Motorized, 280 mm M65 Atomic Cannon.



History of the Atomic Cannon

Development

During the last year of World War II, the Army requested development of a long-range weapon to counteract the heavy guns designed and used by the Germans, such as the 280 mm Krupp railway gun (“Schlanke or Slim Bertha” to the Germans, but better known by the Allied name of “Anzio Annie”). The initial prototype was a T1 240 mm gun that had an initial design completed by 1947.

After the war, the Army Air Corps became a separate branch as the United States Air Force. They immediately began lobbying to become the exclusive delivery system for atomic weapons. In the meantime, the Army had developed a T-124 280 mm atomic shell with a 15-kiloton payload. By 1950, sensing competition from the Air Force, the Army began modifications of the T1 gun to fire the new W-9 atomic warhead. By 1951, the first T131 gun mounted on a T72 carriage was completed. Three were shown to the public and tested with conventional ordinance at Aberdeen Proving Grounds in October 1952. Satisfied with the results, the Army ordered 20 to be produced by 1953.

Due to its size (approximately 85 feet in length and weighing about 1 ton per foot), a transport system was needed. Initial development of a

double-ended tractor system had begun during World War II as a means for transporting tanks. Various designs were considered until Mack produced two 4 wheeled tractors that seemed feasible. One of the prototypes was later modified to carry the T72 carriage, which resulted in the T9 Heavy Transporters. Powered by Ford GAA engines, the transports reached speeds of 30 mph. The final design put into series production was the T10 Trucks ("A" and "B") developed by the Kenworth Motor Truck Company, which became standardized as the M249 Front and M250 Rear Transporters. While only 20 guns were produced, 66 transporters were built. Powered by Continental A0-895-4 engines, the two units had a top speed of 40 mph and a cruising speed of 20 mph. The driver in the front truck was in command and controlled the brakes of both units. Each driver had a communication system to coordinate turns and speed changes.

When finalized, the entire arrangement became known as the M65 Atomic Cannon. One of the completed 20 units participated in the 1953 Inaugural of President Dwight Eisenhower.

Upshot-Knothole

Between March and June 1953, the Atomic Energy Commission conducted a series of 11 nuclear detonations, which was called Operation Upshot Knothole. Going by various code names ("Ruth," "Dixie," "Badger," "Simon"), three were to be airdrops, seven were to be dropped from towers and one (shot "Grable"-named after actress Betty Grable) was to be fired by the atomic cannon. Two cannon systems were transported by rail from Ft. Sill to Las Vegas, where they then traveled over land to the Nevada Proving Grounds at Frenchman's Flat. The cannon had been tested using conventional ordinance to a range of 7 miles, and this was the distance used for Grable. On May 25, 1953, the cannon fired a shell with a successful detonation of the W-9 warhead. Over 21,000 people watched, as the city of Las Vegas offered "Nuclear Packages" with transportation to prime viewing areas. Notable observers included the Secretary of Defense, the Chairman of the Joint Chiefs of Staff, numerous members of Congress, and 2600 troops who were to attack objectives 1.5 miles from ground zero. However, winds from the detonation scattered the troops and disrupted their approach. Long-term adverse health effects from radiation exposure to these individuals are to date unknown. Nevertheless, Grable was considered a resounding success. The result was reported internationally with comments noting that the same destructive force used at Hiroshima, which filled the payload of a 4 engine bomber could now be unleashed using a shell only 11 inches in diameter. Many consider the signing of the Korean Armistice in July 1953 to have been accelerated by the demonstration of atomic firepower 2-3 months prior. Eisenhower had let it be known to the Chinese and North Koreans that, if there was not an immediate cessation of hostilities, "We would remove the limits we were observing as to

the area of combat and the weapons employed.”

Deployment

Field artillery battalions utilizing the atomic cannon were sent to Okinawa and Korea. However, the majority went to Europe. By 1958, 2 were assigned to 7th Army Group, 3 were assigned to V Corps, and 1 was assigned to VII Corps. While considered a “prestige weapon,” maneuvering the cannon and the two transports over the German countryside and through small towns could be problematic. Many stores and houses would lose corners on turns, and tipping of the carriage was common. Eventually, turns were negotiated at speeds no faster than 5 mph. Emplacing the carriage for firing and reassembling the units for travel could supposedly be completed in approximately 15 minutes.

By 1958, Redstone and Lacrosse missile battalions began to supplement, and eventually replace

the M65 cannon. By 1962, Sergeant, Pershing and Honest John Systems were in place, and smaller nuclear projectiles that could be fired by the 203 mm howitzer made the atomic cannon obsolete. The last units were disbanded in December 1963.

Present day

Of the 20 cannons originally built, 8 survive and are on display at various sites throughout the U.S. These include Ft. Sill OK (with transporters-reputed to be the one that fired the Grable shot), Ft. Riley KS, Aberdeen MD (with transporters), Watervliet NY (site of manufacture), Albuquerque NM (with transporters), Yuma AZ, Rock Island IL and Newport News VA.

Videos of the atomic cannon in action can be viewed on YouTube. Of particular interest are those produced by the United States Air Force Lookout Mountain Laboratory (“The 280 mm Gun at the Nevada Proving Ground,” which describes shot Grable) and an early 1950s television program produced by the United States Army (“The Big Picture-This is Aberdeen,” in which the M65 cannon appears at 8:25 min).

The Atomic Cannon Scale Model

The original kit was produced by the Renwal Company in Mineola, NY as part of their Blueprint



Military Series. Older modelers (Boomers) will remember Renwal as the company that produced the visible human, animal and car series in the late 1950s and early 1960s. The atomic cannon was released in 1958, and I acquired it while a young army dependent living in Göppingen, Germany while my father was assigned as a signal officer in the 4th Armored Division. I distinctly remember 2 things regarding what seemed to be, at the time, an enormous model: The transporters with their suspension systems looked impressive, and I could not figure out how to assemble either the gears on the carriage to elevate the barrel, or the differentials, drive shafts and transmissions on the transporters. For an eight year old who could put together any model in a couple of hours, this was a crushing disappointment. In the end, the kit and all its pieces were relegated to the 1958 equivalent of the “Uncle’s Scrap Pile.” As the years went by, I never could get over the fact that this was the one model I could never finish. A career in Medicine limited model building to a minimum. However, as I decreased my workload and retirement approached, I began checking web sites to see if the kit still existed. It did, but not at a price conducive to building. Then, about 3 years ago Revell, which had previously acquired the molds, decided to reissue the kit as part of their Special Projects Series. I

jumped at the chance and had Scale Reproductions preorder one. After 50 years, I once again had it in my possession. As a bonus, they even used the original box art, changing only the name “Atomic Cannon” into bold and colored text. Although I hadn’t planned to start on it right away, other members of MMCL, who had never heard of such a weapon, pressured me into giving this kit top priority.

Since it took more than a year to complete this task, a detailed build log is beyond the scope of this article. What follows are some notes regarding the kit and areas of caution at certain construction points.

The Kit

The box was large (15 x 22 in). Inside were 12 individually bagged medium to large sprues of grey styrene. At least in the original, the sprues were broken into sections (transporters and cannon) and grouped separately. Also, as is common of old 1950s molds, the sprue attachments were either welded to the part, or so thin that many



pieces had already separated. The parts were arranged haphazardly on the sprues. Part numbers were either molded on the piece or on tags attached to the piece. Unfortunately, there was no sprue key in the instructions; a lot of time was spent combing sprues looking for a particular part. This became less problematic as parts were used.

The scale was 1/32, which was common for that era. The kit consisted of multiple components, each models in themselves: The cannon and carriage, the front and rear transporters, two W-9 atomic shells and a crew of seven. Detail of all parts was basic, and dry fitting pieces confirmed their fit to be at best “approximate.” Building an accurately detailed atomic cannon would require using this kit as a template to replace/scratch build essentially all the

parts. I decided something that facsimile of the had the charm kit. Sinkholes, flash abound, lots of putty, blades, sanding boards.

The decal I used the with the intent replacement set,

the company was shipping them free of charge. This would imply that many cannons were shipped without them. As it turned out, the decals were generic. The serial numbers given for the cannon were those of the original Renwal model number. This was an acceptable deficiency, as photos of deployed atomic cannons had disparate markings.

The instructions were otherwise straightforward, and steps were followed as listed. The given paint schemes were also used, which meant a lot of olive drab, steel and aluminum.

Assembly of the Cannon

The gear placement ended up being relatively straightforward. However, they do need to go in a particular order to work. The traversing wheel was modified by sanding off the folded crank handle and replacing it with extended small brass tubing. This made it easier to turn for elevating and lowering the cannon.

The cannon consisted of six parts, four of which were the tubing. It was not rifled. Fit in this case was good and straight. However, it did take a while to remove the seams.

The carriage base and floors have reasonable detail; however, jeweler’s wire



to construct was a reasonable real thing, yet still of an antique ejector pins and which required sets of knife sticks and emery

sheet was missing. Revell web site of ordering a and found that



was used to replace the molded grab handles. The small bolster rollers on the firing base and the wheels of the loading davit were no more than flat disks. A grinding tool was used to develop a concave center. The loading davit had suspensions added using Bob's Buckle's turnbuckles and EZ line. The cable itself was jeweler's wire with a hook composed of epoxy putty. The joining of the deck and frame elements was extremely poor. Much grinding and sanding was necessary to make sure they were flush.

Important tip: Make sure the fit of deck elements to the frame is precise. Otherwise, when the transporters are attached, the lifting forks will be too narrow for their slots on the frames, the turntable and float will not fit, and the center gear will not align with the cannon cradle. On the other hand, a good fit of the frames and floors will mean that the cradle locks for the cannon carriage will be too thick. They will have to be sanded/thinned so the cannon will raise and lower without bumping against them in

transit. Lastly, be careful assembling the cradle with the trunnions on the frame. If they are misaligned, the lock pins will not sit in their depressions on the cradle. In my case, when the cannon was finally installed on the carriage, one pin had perfect alignment, but the other was off by 1 mm. The original depression on that side was filled with putty and the hole redrilled.

The outer platforms for the crew were panels with molded grates, which were too simplistic. Options for improvement included removal of the center and replacing it with generic photoetch grates, or drilling out the plastic between the molds. I chose the latter. The finished product looked more like an over scale grate acceptable for a 1950s model. Ladders were added using strip styrene.

Assembly of the Transporters

While the underside was reasonably detailed, much of both transporters were only partially developed. Drive shafts went nowhere. The two Allison transmissions (torque

converters), drive shaft support/housings and wheel axles had open sides and backs, all of which had to be filled in with sheet and strip styrene, and putty. Assembling the drive shaft support/housing on the differential block brought back frustrating memories of failure as an 8 year old. For the drive shafts to insert correctly into the recesses of the transmissions, they can only point in one direction. This is indicated on the surface of each part by little arrows. Unfortunately, the arrows were not correct for the axles of one of the transporters, which did not become clear until it was time to assemble the undercarriage.

In the end, the builder has one of two choices. Either dry fit the transmissions, shafts, supports and differential housings on the undercarriages of the two transporters before

cementing the shaft support/housing onto the differential covers, or take a chance with the arrows on the housings and differentials. If eventually incorrect, one will have to drill out the opposite end of the drive shaft support/housing and fill in the original opening (which is what I did).

Engine compartments with screens were provided for both transporters. Unfortunately, there were no engines—just a large open space with a hole in the undercarriage where the engine should have been. To remedy this, rudimentary Continental Engines were scratch built using sheet styrene, putty and wire. Oil pans were created below the now closed space, and extensions were created to connect to the transmission drive shaft of the front transporter.

The cabs interiors consisted of a rudimentary bench, a seat, a floorboard, gearshift and steering wheel. Dashboard dials were created



using the larger Archer dry transfers, and stock styrene was used to create throttles and switches. Models from the 1950s had no clear plastic, which meant no glass for the cab windows. Transparency sheets were used for the front and rear windows and the doors were left as if the windows were

open. The components for the cab exterior fit extremely poorly. Large defects in the doors need to be filled, and much sanding and grinding were necessary to make the cabs presentable. The front transformer spare tire davit and cannon wench were bare; jeweler's wire and sheet styrene were used to create cables and hooks.

Two 50-caliber machine guns with mounts were provided. The instructions indicated their location to be on the passenger side roof of both transports. With no hole in the roof, firing these weapons must have been awkward and the field of fire extremely limited. On the other hand, a hole in the roof would have been most unpleasant on maneuvers during the German winters. Although they were included on blueprints of early cannons, I could find no extant photograph of any atomic cannon with installed machine guns. Thus they were left off the assembled model.

On the other hand, photographs of many USAREUR deployed Atomic cannons had hand-made oversize warning signs attached to the transporter bumpers. These were replicated using sheet styrene and computer generated decals, and attached to the bumpers with jeweler's wire.

The forklift surfaces have molded cables to represent brake and communication lines. However, they had no origin or insertion point. Jeweler's wire was used to represent connections to the cannon and transporters. The hoist cylinders aligned poorly with the hooks on the carriage base. A small amount of grinding and sanding corrected this problem.

The warheads and carts

Two shells and handcarts were provided. Assembly is straightforward and, when finished, yields a reasonably accurate result although the shells are over scale. Photographs of W-9 warheads were used as references.

Crew (Figures)

Seven figures are provided: Two loaders posed to pull the carts. Two drivers posed to lean out the transporter windows. Two crewmen posed making adjustments to the cradle or carriage, and one commander posed giving directions. Detail is sparse, items such as helmets and side arms are poorly molded. Flash and sinkholes abound. Facial features are nonexistent or at best bizarre. Suggestion: Discard these without wasting any effort on them.

Final Assembly

Washes and filters were applied using oils, AK enamels and pastels. Finally the finished model was over coated with matt clear.

The instructions indicate that assembly of the cannon to the transporters could be best accomplished by inserting the forklifts and hoist cylinders to the carriage, then placing the lifts in the receptacles on the transporters. However, once the forklifts were wired to the transporters, they could not be removed. Lego blocks were used to create jig to raise the carriage for forklift

insertion.

And so, after over 50 years of waiting and over one year of assembling, the atomic cannon was finally completed. The subject matter was extremely interesting, and I am surprised that another company (Dragon, Tamiya) hasn't developed a more accurate rendering of a 1/35 scale atomic cannon. Cost might be offset by offering each major component (front transporter, rear transporter, cannon/carriage) separately.

I have now learned that models from the 1950s and 60s need a lot of work to generate a precise fit, and such a fit is necessary for alignment or other assembly steps will become a major problem later. Also, large models such as this (over 32 inches in length) have a tendency to show blemishes, so seams and painting must be done carefully. In the end, I am satisfied with the result, but I don't think I'll tackle the Revell reissue of the Renwal Teracruz With Mace Missile any time soon.

References:

1. Gaertner P. The Atomic Cannon: Cold War Deterrent (www.theatomiccannon.com)
2. Franz M, Vollert J. U.S. Army Gun, Heavy, Motorized, 280 mm, M65 Atomic Annie. Technograd Technical Manual Series Number 6008
3. Lamont J. The Atomic Cannon: It was fired only once, but it helped end a war (<http://www.chymist.com/The%20Atomic%20Cannon.pdf>)

President's Page

By Stu Cox

First off, thanks to everyone who was able to attend our 4th of July "Stick It To The Man" workshop event this year! We have 14 modelers show up and work throughout the

morning. We had about the most diverse selection of scale model subjects you could have including armor, aircraft, sci-fi, figures and of course....those shiny primary color glossy clear-coat automobiles! Thanks to the Louisville Model Car Club guys for joining us to round out the event! We even followed up with another good regular Workshop event on Saturday with a similar turnout. Way to go guys! These events are always popular and well attended.

This month we will be meeting on Thursday, July 18th at 7:00 PM for our regularly scheduled club meeting. It's been a few months since we had a regular meeting due to our show in May, and the Friday Night Fights event in June.

Here's what's up for this meeting!

1) **Mig-3 Smackdown** - bring your completed aircraft in and our club members will evaluate and vote on a winner!

2) **Club Television Purchase.** Earlier in the year, we had requests for the club to consider purchasing a flat panel TV for use during club events. At that time, I requested a "sponsor(s)" to research and provide the club with prices for TV's, carts and restraining devices as a "complete setup". Please bring any submissions to this meeting so we can have a final discussion to determine if we will move forward on this. Again, I am looking for proposals for "complete setups" and a volunteer sponsor(s) to act as ongoing "crew chief" for

this system.

3) **Club Raffle** - Great items donated by our members, with \$1 per chance to win. If you write an article and submit for our Tactical Notes Newsletter, you get one free chance. PLEASE - scour your kit stash, and remember your club guys. Please bring in a kit that you would be willing to sacrifice for the viability of your club!

4) The fun part, and reason that we meet! This will be an **IDF/Israeli "Free For All"**! We have had an increased interest and building activity with Israeli armor subjects given the recent new releases. So, let's have an **IDF/Israeli 1948 - Present Show and Tell!** Please bring any of the following to the meeting and we will have a display event including IDF armor, artillery, aircraft, soft-skin or figure items. **Please be prepared to share a very brief summary of your kit subject matter, buildability, and finish materials.**

Now here's the interesting part, this event will include **a) completed & finished models, b) models in process (even if just recently started and not completed) and c) "kits not yet started" still in the box.** The point is, there may be a variety of kits issued on a given subject and progress, and it should be fun to compare and contrast these together regardless if they are completed. Again, anything IDF/Israeli from 1948 to present is welcome to show and discuss!

We had a great turnout of models for our "Old School Model Contest" earlier in the year, so let's try to have a full table again for this event!

Thanks everyone, and we will see you at the meeting on Thursday, July 18th at 7:00PM at the Kyana Building on Hunsinger Lane!

Financial Report

BY ALEX RESTREPO

June 2013 PNC Bank

Starting Cash Balance:		\$5,235.55
Cash Receipts	Date	
Workshop fees	6/3/2013	\$65.00
Workshop fees	6/10/2013	\$25.00
Workshop fees	6/17/2013	\$60.00
Trophy Sponser (LLCC)	6/17/2013	\$25.00
Workshop fees	6/24/2013	\$25.00
Recycle	6/24/2013	\$19.02
Trophy Sponser (DK)	6/24/2013	\$25.00
Member Renewal	6/24/2013	\$10.00
TOTAL RECEIPTS		\$254.02
Cash Or Debit Expenses:	Date	
Check # 7026 (E) KYANNA Rent	5/8/2013	(250.00)
ICheck # 1055 TH Name Badges	6/15/2013	(55.88)
TOTAL EXPENSES		(\$305.88)
NET Monthly Increase(Decrease):		(\$51.86)
ENDING CASH BALANCE:	June 2013	\$5,183.69

Military Modelers of Louisville Membership Form 2013

Name: _____

Address: _____

City: _____ ST: _____ Zip: _____

Phone: _____ E-mail: _____

Birth Date: _____ Year Joined Club: _____

Would you like to receive your newsletter by e-mail? The e-mail version of Tactical Notes is in full color and is sent using the PDF format: Yes _____ No _____

Do you give MMCL permission to place your contact information on the club website: Yes _____ No _____

What are the advantages of membership to the Military Modelers Club of Louisville?

- Monthly meetings held on the third Thursday of the month at the club workshop located at 3821 Hunsinger Lane in Louisville KY.
- A monthly subscription to the official newsletter of the Military Modelers Club of Louisville, Tactical Notes. Tactical Notes contains kit reviews, editorials and modeling techniques.
- The Club Workshop. MMCL has its own club workshop. This is a great place for modelers to build kits and have a good time. The club provides tables, work lights and various tools. We also have quarterly all night model building sessions at this location.
- Quarterly in house model contests with prizes.
- Monthly model kit raffle.
- Annual club cookout.

All of this and more is included in your yearly \$10.00 membership (junior \$5.00) dues.

Please complete all information above and forward your check made out to MMCL for \$10.00 to:

Stu Cox, President
4100 WIMPOLE ROAD
LOUISVILLE, KY 40218
502-499-6618
COX40218@BELLSOUTH.NET

Please visit us on the web at WWW.MMCL.ORG

PD DT _____

Tactical Notes

MMCL
brings
out the
big
guns!



More MMCL Show photos

President Stu rocks the house!

Next meeting: Thursday, July 18th, 7p.m. MiG-3 Smackdown

To contact MMCL:

President:
Stu "Oppenheimer" Cox
Email: Scox2010@gmail.com

Vice President:
Dr. Terry "Teller" Hill
Email: Thill35434@aol.com

Secretary:
David Knights
Email: LOULAW@AOL.COM

Member at Large:
Randy "Fermi" Fuller
Email: Glusnffr@aol.com

Treasurer:
Alex "Lawrence" Restrepo
Email: scox6618@bellsouth.net

Webmangler:
Mike "Feynman" Nofsinger
Email: Mnofsinger@insightbb.com

"Tactical Notes" is the Newsletter of the Military Modelers Club of Louisville, Inc. We appreciate your taking the time to read this little newsletter. We'd appreciate it even more if you would write something. **Yes, I am talking to you!**

Cover Photos: Dennis O'Connor's Atomic Cannon
Photo composite by Randy Fuller



Russ Fischer's Ford GT 40

Editor's Note

This issue contains an article that I've been waiting to get published. Doc's Atomic Cannon has been a real odyssey for him. Those who have seen him work on it at the shop couldn't help but be impressed. I made him promise early on that he'd do an article for me when it was done. Being a man of his word, he has delivered and I am very happy to present it to you in this issue.

I missed our Friday Night Fight meeting. Like many folks, summer can be tough for making meetings. I have to say I was impressed by the photos posted on Facebook showing all the people who made the meeting. Let's keep it on a roll and have a great turnout for our July meeting.

I've put a few more photos from the recent show in this issue. I'll keep putting these in coming issues so anyone who didn't attend and hasn't been able to view the photos online will get to see some of the great work that was on display at the show.

Finally, again I want to express my thanks to everyone who has written for the newsletter. Your hard work has allowed us to be the Region 4 newsletter of the year two years in a row. It has also allowed me to lay out issues a month or two in advance as well as work on some special issues. More on that in the near future.



You asked for it.

Randy Fuller
MMCL/Eastern Bloc
Member-at-Large

My Secrets to Model Photography

May 18th provided me a target rich environment! I am pleased that MMCL trusted me to document this year's Invitational show again. As many of you have been admiring my photographs of some truly stunning models, I will share with you some of my tips. Now, I realize most people use the cameras on their smartphones, but as a die-hard SLR guy, I still think the best come from a more conventional camera. These tips are more about the technique rather than the equipment.

For better close-ups, step back.

When photographing miniatures, we want to capture the smallest of details, but moving in tight on a model will limit how much of it will actually be in focus. This is a limitation of the camera known as depth of field. To get more of the model in focus, step back a few feet and use a zoom lens. You'll have greater depth of field and can always digitally zoom in tighter for the smaller details.

Add the light, lose the shadow.

When you look at a model in any light, you see an evenly exposed scene, but when you capture that with a camera, it's a different story. Film and digital

media need much more light than the human eye, so a flash (strobe) is an easy way to add a lot of intense, bright, white light to illuminate a scene. The problem is a lot of focused light creates really bright and really dark areas. To cut the harsh shadows, use a diffuser on the flash. You can by inexpensive plastic diffusers that fit right over your camera's built in flash, or you can improvise. Use frosted Scotch tape right over the flash lens to soften the light. A piece of thin tissue paper held in place will also cut the shadows. Be sure to try a couple of different settings to make sure you know the correct exposure to use.

Unless you have wings, loose the bird's-eye view.

Almost every shot you see of a model is above it looking down. While this give the viewer a comprehensive shot of the overall model, it is rarely on seen in nature. Look at photos of real objects, and it's on eye level or maybe even looking up. Try to match these angles when photographing models. Get down and look at the model form a lower angle. A dynamic angle will add some more realism to your shots as well as being visibly interesting.

Don't sweat the scale color; learn the color of the light.

Green isn't green if the light you're photographing with is blue. Color balance is the most overlooked and least understood aspect of photography. It is even important in black and white photography! Our eyes are remarkably adaptable to various light sources, but our cameras

not-so-much. A flash or strobe will give you the next best thing to sunlight, but artificial light will have a variety of color shifts. Use the auto white balance on your camera, but it's best to retouch in post processing for the most accurate color balance. Most photo editing software programs have a white-balance adjustment. If you have a portion of the photo that has white in it, you can usually just click the icon and select the white area for an automatic adjustment.



Lee Fogel's 1/48th scale He-51 from the 2013 MMCL show.

More is More

Digital memory is cheap. Don't skimp on the shots! If you take a few to several different photos – different angles, exposures, etc... -- you may find that one perfect shot. Photographers today take dozens to hundreds to thousands of shots on a job. This assures you WILL capture "the one"! Click away!

Chris Toops' winter schemed PzIII at the MMCL 2013 show



The Cranky Canuck "I'm back edition."

By Jim Bates

The Seafire Mk. XV

The Griffon-engined Seafire Mk. XV was the Royal Canadian Navy's introduction to fighter aircraft in the early post war years. Thirty five were taken on strength by the RCAF in 1946. They were transferred to the RCN in 1947, even though they had been operated by the Navy for the previous year. The Seafires were flown off the HMCS Warrior by 803 and 883 Squadrons until being replaced by Sea Furies in 1948; after which they were operated for training and exhibition purposes until late 1949. The remaining aircraft at that time were relegated to use as ground based training aids. Two former Royal Canadian Navy Seafires survive today, one in a Museum in Alberta and an airworthy example with a private owner in the United States.



The Seafire Mk. XV in 1/72 Scale

As far as I know, the first complete Seafire Mk. XV kit was issued by Ventura Hobby Products of New Zealand in the 1980s. This is a very early example of a short run injection molded plastic kit with thick sprue gates, extensive flash, brittle plastic, and flow lines inside the parts that resemble tree roots. It had some metal parts, vacuform canopies, and a nice decal sheet that included a Royal Canadian Navy example. I'm sure a very experience modeler could turn out a nice model from this kit, but for the rest of us mere mortals, it really isn't worth considering. The plastic in my example was so brittle it was impossible to remove the parts from the sprues without them shattering.

Next up to bat was Czech Master Resin with two different Seafires; an "A Frame" tail hook and a "stinger" tail hook example. My kit is the "stinger" tail hook version and it contains very nice decals for two RCN Seafires; an Extra Dark Sea Gray and Sky aircraft from 803 Squadron (Which actually is Extra Dark Sea Gray and Dark Slate Gray over Sky), and a two tone gray example from 883 Squadron. The CMR kits are molded in two types of resin; the main fuselage halves and the one piece wing are in a light cream coloured resin, while the detail parts are in a darker shade. Two vacuform canopies are also included. The detail parts are well molded and the detail is good. The cock-

pit has some sidewall detail, a seat, a “floor,” a control column, an instrument panel, rear armor, and rudder pedals. Not spectacular, but good enough for the scale. The fuselage and wings have well done engraved scribing, but my example has one or two unfortunately located air bubbles. At the time it was issued, it was by far the best Seafire on the market, but being a resin kit, it will take a little extra work to construct and some experience with CA glue. (A few years after the release of the kit, CMR also issued a resin wing fold conversion that included decals for a different two tone gray RCN example from 883 Squadron. I have not seen this set, so I cannot comment further.)

The most recent contender in the 1/72 Seafire sweepstakes is the Sword kit. Once again issued in two versions, my kit is the “late” issue which includes the stinger arrest hook, but no RCN decals. (The “early” issue appears to include a second sprue with additional fuselage halves to build an “A Frame” hooked Seafire. It also appear to contain decals for an 883 Squadron Seafire in the two tone gray scheme.) The kit contains one sprue of grayish-blue plastic parts, an injection molded canopy, and four resin parts. The plastic parts are beautiful with only a

small amount of flash. While ostensibly short run technology - for example there are no locating pins - they look as good as many kits from major manufactures. About the only flaw on my example was that the spade grip on the control column was not fully molded. There is some nice sidewall detail in the cockpit, along with 11 plastic parts. Cockpit detail is a notch or two above the CMR kit and is excellent for the scale. Two wheel options are included, three spoke and four spoke wheels, but the propeller and spinner are six pieces and could be slightly tricky to assemble. Exterior scribing is

engraved and quite petite and fine. The major parts of the Sword and CMR kits line up well and both appear quite accurate. My only complaint with the kit is that there is an odd raised



area under the wing where the shell injection shoots should be for the cannons. I’m not sure what Sword did here, maybe basing their kit off a preserved example that has the area plugged? There are some large pin injection towers on the inside surfaces of the wing which will need to be removed, but doing so will be easy with some sprue cutters. Three options are provided on the decal sheet, all from the Fleet Air Arm. This looks like an excellent kit, and the best op-

tion for a RCN Seafire in 1/72 scale, but care will still need to be taken with assembly.

Both the Sword Seafire and the CMR kit and conversion can be purchased from West Coast Hobbys of British Columbia (<http://www.westcoasthobbys.com/>) and alternate RCN Seafire decals can be found on Belcher Bits Sheet BD17 (<http://www.belcherbits.com>).

New U.S. Navy Decal

Starfighter Decals 72-138 Colorful Dauntless

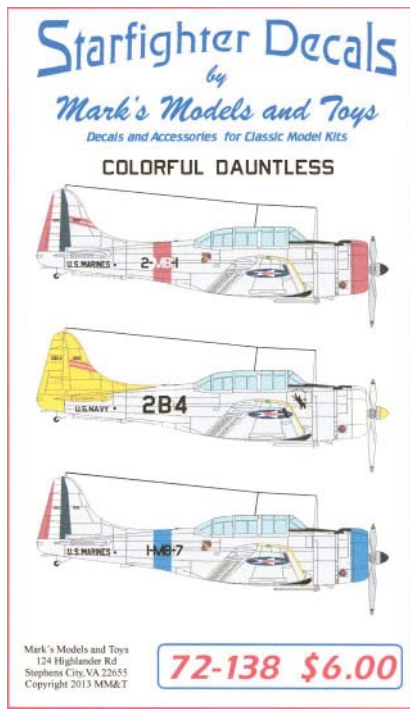

less: Recently release by Starfighter decals is this very colorful sheet with options for two USMC SBD-1 and one U.S. Navy SBD-2 “Yellow Wings” Dauntlesses. Beautifully printed, you get all the individual markings for each

subject but only one set of national insignia. A small color placement guide is included. The two USMC options will require a SBD-1 conversion set that Starfighter hopes to release later in the year For \$6 this sheet is excellent value for the money and highly recommend if you want add some color to your

model shelf. (<http://www.starfighter-decals.com>)

fündekals 1/72 Lt(jg). Daniel A. Carmichael’s VBF-12 F6F-5 Hellcat: fündekals is a new manufacturer that has decided to take a new approach to decal production. They are doing one subject sheets with no printed instructions in all major scales. In this case, the single option is for Lt. Charmichael’s Hellcat. The sheet has serials, codes, and kills markings but you will need to source your national insignia from the kit and paint your own white stripes on the tail. No muss, no fuss. Everything is perfectly printed and you are directed to www.fundekals.com to download an instruction sheet for decal placement and scheme information. The PDF download is very well done with a three view drawing, measurements to paint the aforesaid white stripes, and historical photos of the subject aircraft. I really like this idea of affordable small sheets with one option. Rumor has it that some additional U.S. Navy subjects are in the offing. (<http://www.fundekals.com>)



The M65 Atomic Cannon Scale Model: A Build That Took Over 50 Years to Complete

By Dennis “Doc” O’Connor

The following documents a journey that began in Germany around 1958 and pretty much spans a lifetime. In the end, I haven’t decided whether to smile and say that perseverance triumphed over adversity, or to sigh and grumble that it would have better to have left well enough alone. This then is the story of tackling the Revell reissue of the U.S. Army Gun, Heavy, Motorized, 280 mm M65 Atomic Cannon.



History of the Atomic Cannon

Development

During the last year of World War II, the Army requested development of a long-range weapon to counteract the heavy guns designed and used by the Germans, such as the 280 mm Krupp railway gun (“Schlanke or Slim Bertha” to the Germans, but better known by the Allied name of “Anzio Annie”). The initial prototype was a T1 240 mm gun that had an initial design completed by 1947.

After the war, the Army Air Corps became a separate branch as the United States Air Force. They immediately began lobbying to become the exclusive delivery system for atomic weapons. In the meantime, the Army had developed a T-124 280 mm atomic shell with a 15-kiloton payload. By 1950, sensing competition from the Air Force, the Army began modifications of the T1 gun to fire the new W-9 atomic warhead. By 1951, the first T131 gun mounted on a T72 carriage was completed. Three were shown to the public and tested with conventional ordinance at Aberdeen Proving Grounds in October 1952. Satisfied with the results, the Army ordered 20 to be produced by 1953.

Due to its size (approximately 85 feet in length and weighing about 1 ton per foot), a transport system was needed. Initial development of a

double-ended tractor system had begun during World War II as a means for transporting tanks. Various designs were considered until Mack produced two 4 wheeled tractors that seemed feasible. One of the prototypes was later modified to carry the T72 carriage, which resulted in the T9 Heavy Transporters. Powered by Ford GAA engines, the transports reached speeds of 30 mph. The final design put into series production was the T10 Trucks ("A" and "B") developed by the Kenworth Motor Truck Company, which became standardized as the M249 Front and M250 Rear Transporters. While only 20 guns were produced, 66 transporters were built. Powered by Continental A0-895-4 engines, the two units had a top speed of 40 mph and a cruising speed of 20 mph. The driver in the front truck was in command and controlled the brakes of both units. Each driver had a communication system to coordinate turns and speed changes.

When finalized, the entire arrangement became known as the M65 Atomic Cannon. One of the completed 20 units participated in the 1953 Inaugural of President Dwight Eisenhower.

Upshot-Knothole

Between March and June 1953, the Atomic Energy Commission conducted a series of 11 nuclear detonations, which was called Operation Upshot Knothole. Going by various code names ("Ruth," "Dixie," "Badger," "Simon"), three were to be airdrops, seven were to be dropped from towers and one (shot "Grable"-named after actress Betty Grable) was to be fired by the atomic cannon. Two cannon systems were transported by rail from Ft. Sill to Las Vegas, where they then traveled over land to the Nevada Proving Grounds at Frenchman's Flat. The cannon had been tested using conventional ordinance to a range of 7 miles, and this was the distance used for Grable. On May 25, 1953, the cannon fired a shell with a successful detonation of the W-9 warhead. Over 21,000 people watched, as the city of Las Vegas offered "Nuclear Packages" with transportation to prime viewing areas. Notable observers included the Secretary of Defense, the Chairman of the Joint Chiefs of Staff, numerous members of Congress, and 2600 troops who were to attack objectives 1.5 miles from ground zero. However, winds from the detonation scattered the troops and disrupted their approach. Long-term adverse health effects from radiation exposure to these individuals are to date unknown. Nevertheless, Grable was considered a resounding success. The result was reported internationally with comments noting that the same destructive force used at Hiroshima, which filled the payload of a 4 engine bomber could now be unleashed using a shell only 11 inches in diameter. Many consider the signing of the Korean Armistice in July 1953 to have been accelerated by the demonstration of atomic firepower 2-3 months prior. Eisenhower had let it be known to the Chinese and North Koreans that, if there was not an immediate cessation of hostilities, "We would remove the limits we were observing as to

the area of combat and the weapons employed.”

Deployment

Field artillery battalions utilizing the atomic cannon were sent to Okinawa and Korea. However, the majority went to Europe. By 1958, 2 were assigned to 7th Army Group, 3 were assigned to V Corps, and 1 was assigned to VII Corps. While considered a “prestige weapon,” maneuvering the cannon and the two transports over the German countryside and through small towns could be problematic. Many stores and houses would lose corners on turns, and tipping of the carriage was common. Eventually, turns were negotiated at speeds no faster than 5 mph. Emplacing the carriage for firing and reassembling the units for travel could supposedly be completed in approximately 15 minutes.

By 1958, Redstone and Lacrosse missile battalions began to supplement, and eventually replace

the M65 cannon. By 1962, Sergeant, Pershing and Honest John Systems were in place, and smaller nuclear projectiles that could be fired by the 203 mm howitzer made the atomic cannon obsolete. The last units were disbanded in December 1963.

Present day

Of the 20 cannons originally built, 8 survive and are on display at various sites throughout the U.S. These include Ft. Sill OK (with transporters-reputed to be the one that fired the Grable shot), Ft. Riley KS, Aberdeen MD (with transporters), Watervliet NY (site of manufacture), Albuquerque NM (with transporters), Yuma AZ, Rock Island IL and Newport News VA.

Videos of the atomic cannon in action can be viewed on YouTube. Of particular interest are those produced by the United States Air Force Lookout Mountain Laboratory (“The 280 mm Gun at the Nevada Proving Ground,” which describes shot Grable) and an early 1950s television program produced by the United States Army (“The Big Picture-This is Aberdeen,” in which the M65 cannon appears at 8:25 min). **The Atomic Cannon Scale Model**

The original kit was produced by the Renwal Company in Mineola, NY as part of their Blueprint



Military Series. Older modelers (Boomers) will remember Renwal as the company that produced the visible human, animal and car series in the late 1950s and early 1960s. The atomic cannon was released in 1958, and I acquired it while a young army dependent living in Göppingen, Germany while my father was assigned as a signal officer in the 4th Armored Division. I distinctly remember 2 things regarding what seemed to be, at the time, an enormous model: The transporters with their suspension systems looked impressive, and I could not figure out how to assemble either the gears on the carriage to elevate the barrel, or the differentials, drive shafts and transmissions on the transporters. For an eight year old who could put together any model in a couple of hours, this was a crushing disappointment. In the end, the kit and all its pieces were relegated to the 1958 equivalent of the “Uncle’s Scrap Pile.” As the years went by, I never could get over the fact that this was the one model I could never finish. A career in Medicine limited model building to a minimum. However, as I decreased my workload and retirement approached, I began checking web sites to see if the kit still existed. It did, but not at a price conducive to building. Then, about 3 years ago Revell, which had previously acquired the molds, decided to reissue the kit as part of their Special Projects Series. I

jumped at the chance and had Scale Reproductions preorder one. After 50 years, I once again had it in my possession. As a bonus, they even used the original box art, changing only the name “Atomic Cannon” into bold and colored text. Although I hadn’t planned to start on it right away, other members of MMCL, who had never heard of such a weapon, pressured me into giving this kit top priority.

Since it took more than a year to complete this task, a detailed build log is beyond the scope of this article. What follows are some notes regarding the kit and areas of caution at certain construction points.

The Kit

The box was large (15 x 22 in). Inside were 12 individually bagged medium to large sprues of grey styrene. At least in the original, the sprues were broken into sections (transporters and cannon) and grouped separately. Also, as is common of old 1950s molds, the sprue attachments were either welded to the part, or so thin that many



pieces had already separated. The parts were arranged haphazardly on the sprues. Part numbers were either molded on the piece or on tags attached to the piece. Unfortunately, there was no sprue key in the instructions; a lot of time was spent combing sprues looking for a particular part. This became less problematic as parts were used.

The scale was 1/32, which was common for that era. The kit consisted of multiple components, each models in themselves: The cannon and carriage, the front and rear transporters, two W-9 atomic shells and a crew of seven. Detail of all parts was basic, and dry fitting pieces confirmed their fit to be at best “approximate.” Building an accurately detailed atomic cannon would require using this kit as a template to replace/scratch build essentially all the

parts. I decided something that facsimile of the had the charm kit. Sinkholes, flash abound, lots of putty, blades, sanding boards.

The decal I used the with the intent replacement set,

the company was shipping them free of charge. This would imply that many cannons were shipped without them. As it turned out, the decals were generic. The serial numbers given for the cannon were those of the original Renwal model number. This was an acceptable deficiency, as photos of deployed atomic cannons had disparate markings.

The instructions were otherwise straightforward, and steps were followed as listed. The given paint schemes were also used, which meant a lot of olive drab, steel and aluminum.

Assembly of the Cannon

The gear placement ended up being relatively straightforward. However, they do need to go in a particular order to work. The traversing wheel was modified by sanding off the folded crank handle and replacing it with extended small brass tubing. This made it easier to turn for elevating and lowering the cannon.

The cannon consisted of six parts, four of which were the tubing. It was not rifled. Fit in this case was good and straight. However, it did take a while to remove the seams.

The carriage base and floors have reasonable detail; however, jeweler’s wire



to construct was a reasonable real thing, yet still of an antique ejector pins and which required sets of knife sticks and emery

sheet was missing. Revell web site of ordering a and found that



was used to replace the molded grab handles. The small bolster rollers on the firing base and the wheels of the loading davit were no more than flat disks. A grinding tool was used to develop a concave center. The loading davit had suspensions added using Bob's Buckle's turnbuckles and EZ line. The cable itself was jeweler's wire with a hook composed of epoxy putty. The joining of the deck and frame elements was extremely poor. Much grinding and sanding was necessary to make sure they were flush.

Important tip: Make sure the fit of deck elements to the frame is precise. Otherwise, when the transporters are attached, the lifting forks will be too narrow for their slots on the frames, the turntable and float will not fit, and the center gear will not align with the cannon cradle. On the other hand, a good fit of the frames and floors will mean that the cradle locks for the cannon carriage will be too thick. They will have to be sanded/thinned so the cannon will raise and lower without bumping against them in

transit. Lastly, be careful assembling the cradle with the trunnions on the frame. If they are misaligned, the lock pins will not sit in their depressions on the cradle. In my case, when the cannon was finally installed on the carriage, one pin had perfect alignment, but the other was off by 1 mm. The original depression on that side was filled with putty and the hole redrilled.

The outer platforms for the crew were panels with molded grates, which were too simplistic. Options for improvement included removal of the center and replacing it with generic photoetch grates, or drilling out the plastic between the molds. I chose the latter. The finished product looked more like an over scale grate acceptable for a 1950s model. Ladders were added using strip styrene.

Assembly of the Transporters

While the underside was reasonably detailed, much of both transporters were only partially developed. Drive shafts went nowhere. The two Allison transmissions (torque

converters), drive shaft support/housings and wheel axles had open sides and backs, all of which had to be filled in with sheet and strip styrene, and putty. Assembling the drive shaft support/housing on the differential block brought back frustrating memories of failure as an 8 year old. For the drive shafts to insert correctly into the recesses of the transmissions, they can only point in one direction. This is indicated on the surface of each part by little arrows. Unfortunately, the arrows were not correct for the axles of one of the transporters, which did not become clear until it was time to assemble the undercarriage.

In the end, the builder has one of two choices. Either dry fit the transmissions, shafts, supports and differential housings on the undercarriages of the two transporters before

cementing the shaft support/housing onto the differential covers, or take a chance with the arrows on the housings and differentials. If eventually incorrect, one will have to drill out the opposite end of the drive shaft support/housing and fill in the original opening (which is what I did).

Engine compartments with screens were provided for both transporters. Unfortunately, there were no engines—just a large open space with a hole in the undercarriage where the engine should have been. To remedy this, rudimentary Continental Engines were scratch built using sheet styrene, putty and wire. Oil pans were created below the now closed space, and extensions were created to connect to the transmission drive shaft of the front transporter.

The cabs interiors consisted of a rudimentary bench, a seat, a floorboard, gearshift and steering wheel. Dashboard dials were created



using the larger Archer dry transfers, and stock styrene was used to create throttles and switches. Models from the 1950s had no clear plastic, which meant no glass for the cab windows. Transparency sheets were used for the front and rear windows and the doors were left as if the windows were

open. The components for the cab exterior fit extremely poorly. Large defects in the doors need to be filled, and much sanding and grinding were necessary to make the cabs presentable. The front transformer spare tire davit and cannon wench were bare; jeweler's wire and sheet styrene were used to create cables and hooks.

Two 50-caliber machine guns with mounts were provided. The instructions indicated their location to be on the passenger side roof of both transports. With no hole in the roof, firing these weapons must have been awkward and the field of fire extremely limited. On the other hand, a hole in the roof would have been most unpleasant on maneuvers during the German winters. Although they were included on blueprints of early cannons, I could find no extant photograph of any atomic cannon with installed machine guns. Thus they were left off the assembled model.

On the other hand, photographs of many USAREUR deployed Atomic cannons had hand-made oversize warning signs attached to the transporter bumpers. These were replicated using sheet styrene and computer generated decals, and attached to the bumpers with jeweler's wire.

The forklift surfaces have molded cables to represent brake and communication lines. However, they had no origin or insertion point. Jeweler's wire was used to represent connections to the cannon and transporters. The hoist cylinders aligned poorly with the hooks on the carriage base. A small amount of grinding and sanding corrected this problem.

The warheads and carts

Two shells and handcarts were provided. Assembly is straightforward and, when finished, yields a reasonably accurate result although the shells are over scale. Photographs of W-9 warheads were used as references.

Crew (Figures)

Seven figures are provided: Two loaders posed to pull the carts. Two drivers posed to lean out the transporter windows. Two crewmen posed making adjustments to the cradle or carriage, and one commander posed giving directions. Detail is sparse, items such as helmets and side arms are poorly molded. Flash and sinkholes abound. Facial features are nonexistent or at best bizarre. Suggestion: Discard these without wasting any effort on them.

Final Assembly

Washes and filters were applied using oils, AK enamels and pastels. Finally the finished model was over coated with matt clear.

The instructions indicate that assembly of the cannon to the transporters could be best accomplished by inserting the forklifts and hoist cylinders to the carriage, then placing the lifts in the receptacles on the transporters. However, once the forklifts were wired to the transporters, they could not be removed. Lego blocks were used to create jig to raise the carriage for forklift

insertion.

And so, after over 50 years of waiting and over one year of assembling, the atomic cannon was finally completed. The subject matter was extremely interesting, and I am surprised that another company (Dragon, Tamiya) hasn't developed a more accurate rendering of a 1/35 scale atomic cannon. Cost might be offset by offering each major component (front transporter, rear transporter, cannon/carriage) separately.

I have now learned that models from the 1950s and 60s need a lot of work to generate a precise fit, and such a fit is necessary for alignment or other assembly steps will become a major problem later. Also, large models such as this (over 32 inches in length) have a tendency to show blemishes, so seams and painting must be done carefully. In the end, I am satisfied with the result, but I don't think I'll tackle the Revell reissue of the Renwal Teracruz With Mace Missile any time soon.

References:

1. Gaertner P. The Atomic Cannon: Cold War Deterrent (www.theatomiccannon.com)
2. Franz M, Vollert J. U.S. Army Gun, Heavy, Motorized, 280 mm, M65 Atomic Annie. Technograd Technical Manual Series Number 6008
3. Lamont J. The Atomic Cannon: It was fired only once, but it helped end a war (<http://www.chymist.com/The%20Atomic%20Cannon.pdf>)

President's Page

By Stu Cox

First off, thanks to everyone who was able to attend our 4th of July "Stick It To The Man" workshop event this year! We have 14 modelers show up and work throughout the

morning. We had about the most diverse selection of scale model subjects you could have including armor, aircraft, sci-fi, figures and of course....those shiny primary color glossy clear-coat automobiles! Thanks to the Louisville Model Car Club guys for joining us to round out the event! We even followed up with another good regular Workshop event on Saturday with a similar turnout. Way to go guys! These events are always popular and well attended.

This month we will be meeting on Thursday, July 18th at 7:00 PM for our regularly scheduled club meeting. It's been a few months since we had a regular meeting due to our show in May, and the Friday Night Fights event in June.

Here's what's up for this meeting!

1) **Mig-3 Smackdown** - bring your completed aircraft in and our club members will evaluate and vote on a winner!

2) **Club Television Purchase.** Earlier in the year, we had requests for the club to consider purchasing a flat panel TV for use during club events. At that time, I requested a "sponsor(s)" to research and provide the club with prices for TV's, carts and restraining devices as a "complete setup". Please bring any submissions to this meeting so we can have a final discussion to determine if we will move forward on this. Again, I am looking for proposals for "complete setups" and a volunteer sponsor(s) to act as ongoing "crew chief" for

this system.

3) **Club Raffle** - Great items donated by our members, with \$1 per chance to win. If you write an article and submit for our Tactical Notes Newsletter, you get one free chance. PLEASE - scour your kit stash, and remember your club guys. Please bring in a kit that you would be willing to sacrifice for the viability of your club!

4) The fun part, and reason that we meet! This will be an **IDF/Israeli "Free For All"**! We have had an increased interest and building activity with Israeli armor subjects given the recent new releases. So, let's have an **IDF/Israeli 1948 - Present Show and Tell!** Please bring any of the following to the meeting and we will have a display event including IDF armor, artillery, aircraft, soft-skin or figure items. **Please be prepared to share a very brief summary of your kit subject matter, buildability, and finish materials.**

Now here's the interesting part, this event will include **a) completed & finished models, b) models in process (even if just recently started and not completed) and c) "kits not yet started" still in the box.** The point is, there may be a variety of kits issued on a given subject and progress, and it should be fun to compare and contrast these together regardless if they are completed. Again, anything IDF/Israeli from 1948 to present is welcome to show and discuss!

We had a great turnout of models for our "Old School Model Contest" earlier in the year, so let's try to have a full table again for this event!

Thanks everyone, and we will see you at the meeting on Thursday, July 18th at 7:00PM at the Kyana Building on Hunsinger Lane!

Financial Report

BY ALEX RESTREPO

June 2013 PNC Bank

Starting Cash Balance:		\$5,235.55
Cash Receipts	Date	
Workshop fees	6/3/2013	\$65.00
Workshop fees	6/10/2013	\$25.00
Workshop fees	6/17/2013	\$60.00
Trophy Sponser (LLCC)	6/17/2013	\$25.00
Workshop fees	6/24/2013	\$25.00
Recycle	6/24/2013	\$19.02
Trophy Sponser (DK)	6/24/2013	\$25.00
Member Renewal	6/24/2013	\$10.00
TOTAL RECEIPTS		\$254.02
Cash Or Debit Expenses:	Date	
Check # 7026 (E) KYANNA Rent	5/8/2013	(250.00)
ICheck # 1055 TH Name Badges	6/15/2013	(55.88)
TOTAL EXPENSES		(\$305.88)
NET Monthly Increase(Decrease):		(\$51.86)
ENDING CASH BALANCE:	June 2013	\$5,183.69

Military Modelers of Louisville Membership Form 2013

Name: _____

Address: _____

City: _____ ST: _____ Zip: _____

Phone: _____ E-mail: _____

Birth Date: _____ Year Joined Club: _____

Would you like to receive your newsletter by e-mail? The e-mail version of Tactical Notes is in full color and is sent using the PDF format: Yes _____ No _____

Do you give MMCL permission to place your contact information on the club website: Yes _____ No _____

What are the advantages of membership to the Military Modelers Club of Louisville?

- Monthly meetings held on the third Thursday of the month at the club workshop located at 3821 Hunsinger Lane in Louisville KY.
- A monthly subscription to the official newsletter of the Military Modelers Club of Louisville, Tactical Notes. Tactical Notes contains kit reviews, editorials and modeling techniques.
- The Club Workshop. MMCL has its own club workshop. This is a great place for modelers to build kits and have a good time. The club provides tables, work lights and various tools. We also have quarterly all night model building sessions at this location.
- Quarterly in house model contests with prizes.
- Monthly model kit raffle.
- Annual club cookout.

All of this and more is included in your yearly \$10.00 membership (junior \$5.00) dues.

Please complete all information above and forward your check made out to MMCL for \$10.00 to:

Stu Cox, President
4100 WIMPOLE ROAD
LOUISVILLE, KY 40218
502-499-6618
COX40218@BELLSOUTH.NET

Please visit us on the web at WWW.MMCL.ORG

PD DT _____

Tactical Notes

F-16N Smackdown photos
Articles to follow?



*The Crazy Canuck: Now
100% Poutine-free!*

Tom Draper's Ju-86P
in 72nd scale!



Next meeting: August 22nd, 6 p.m. Summer Dinner Meeting
Champps Americana

2012 and 2013 Region 4 Newsletter of the Year!

To contact MMCL:

President:
Stu "Fidel" Cox
Email: Scox2010@gmail.com

Vice President:
Dr. Terry "Che" Hill
Email: Thill35434@aol.com

Secretary:
David Knights
Email: LOULAW@AOL.COM

Member at Large:
Randy "Uncle Ho" Fuller
Email: Glusnffr@aol.com

Treasurer:
Alex "Kim II" Restrepo
Email: scox6618@bellsouth.net

Webmangler:
Mike "Pol Pot" Nofsinger
Email: Mnofsinger@insightbb.com

"**Tactical Notes**" is the Newsletter of the Military Modelers Club of Louisville, Inc. We appreciate your taking the time to read this little newsletter. We'd appreciate it even more if you would write something. **Yes, I am talking to you!**

Cover Photos: Daniel Ledford's winning F-16 in the recent F-16 throwdown between Randy Fuller and Daniel Ledford. Photo by Randy Fuller.

Randy and Daniel's F-16s



Editor's Note

If you missed the last meeting, you missed a good one. The MiG-3 smackdown was judged. We had four great entries. I am glad to see the smackdowns making a comeback as they stimulate model-building, which is what MMCL is all about at its core.

In addition we had a great show and tell with a wide variety of completed and almost completed models. We had a super raffle and a presentation on models depicting items that have fought in the various Arab-Israeli conflicts. Also, for a July meeting we had a great turnout. Usually July and August are our two smallest months for attendance due to vacations and the press of summer activities. I remember a long time ago we had an August meeting with just 5 members.

The recent series of articles contributed by members has allowed me to expand the newsletter and to work a bit ahead. I am now beginning the layout of the next month's issue before the current month's meeting. I really appreciate this as it helps me be better organized and is giving me a chance to do a couple of theme issues. More on that in the future. Please keep those articles coming. If you need help with photos or writing and editing I am always glad to assist. Also, continued thanks to Dennis, Randy and Jim. Without your regular contributions I would have a tougher hill to climb each month.

Bad Czech

By Tom Draper

Produced in the manly and correct 1/72 scale, the RS Junkers Ju 86P/R kit joins the Azur LEO C.130 and the Frog Blackburn Shark in the rarified and legendary “Impossible to Build as Presented” (IBP) category. Like all RS kits, the Ju 86P has great detail treatment on the outside rivaling any Asian-produced kit. The plastic itself is also very good to work with. And it looks good right out of the box so that we think we have a real winner as well as a unique model here. However, once again, those cwazy boyz at RS have another laff riot on their hands, as in “Let those guys try and build *this one*”.

The main components seem like they will fit perfectly, setting up the first “Are you kidding me?” moment: the interior. Apart from the floor, seats, and (very) few other parts like the control yoke, everything is in photo etch. In the instructions, things look buildable, until you see the size of the things they want you triple bend are actually 2mm long. I took the low road and made up only the main PE parts, gluing them to plastic card for depth where appropriate. Since everything is behind two well made Airfix style canopy and nose clear sections,

things turned out all right.

The next step was to tackle the impossible and impassible problem of handling the Stuka-styled trailing flaps. The barrel of laffs is that the cwazy boyz want you to hang them with a bunch of tiny PE hinges, which are impossible to fix to the trailing edge of the top wing and even more impossible to fix to the trailing flaps. So did I collapse in a tantrum like Elmer Fudd? I did not! (Well actually I did, but I added a bunch of manly highly inventive cursing to make my



display much more macho). My solution was as successful as it was crafty, (and lucky). I happened to have in my stash three, count them, three Italari Ju 86 bomber kits I bought back when

everything cost 37 cents. I found out that the cwazy boyz based their kit on the Italari kit in many ways, naturally converting it in the process so that it was 5 times more difficult to build. My solution was to take the inboard two flaps from a bomber and glue them to the P version. They fit perfectly. The solution for the longer outboard flap was to use the P flap and glue it to the outboard edge of the middle bomber flap, using the hinges from the unused bomber flap. That that, cwazy boys!

After that, taking a clue from

the box color, it was the usual RS blues. All their kit pieces *look* great, but every sub assembly must be trial fitted and corrected, which takes about three times longer than the average kit – if you can figure out how they are supposed to go together. Then, of course, you come to the booby traps the CBz add in to increase their merry making. For



example, the mounting holes in the wheels are too small for their axles. And you don't find out until you have everything in place and don't have the drill size to match the axles.

Finally everything is completed. The decals adhere very well (use water only to position RS decals and check to see that the marking are printed in alignment). You have of course, completely corrected the props to fit their hubs and vice versa and found a solution for the 1mm prop shaft problem ... Yup, I didn't.

However, I must say when everything was completed and my hobby bench was finally set up in the sanatorium, the model did look pretty good. It's just that I wish that within the one half of the Czech population that is not involved in model kit

production, someone actually tries to build some of those kits before they are shipped out of the country, causing mass consternation and the heartbreak of psoriasis. But that

The Granma

By Foster Rash

(This article originally appeared in the April issue of the IPMS Orange County Newsletter and is kindly reprinted with their permission.)

In November 1956, 82 men boarded a small yacht and set sail for Cuba with the intention to overthrow the government of the dictator General Fulgencio Batista. The leader of the group was a 30 year old attorney named Fidel Castro. The yacht *Granma*, designed for only 12 passengers, was loaded with arms and an additional 2,000 gallons of fuel on deck for the voyage from Tuxpan, on the Mexican coast, to southeastern Cuba. It was a miserable 1,200 mile voyage. Many of the men were seasick and one man fell overboard in the night. The engines were in poor condition and gave constant trouble. The seas were rough and the heavily loaded vessel began taking on water. For a while it looked as if the boat might sink.



Castro had estimated the trip would take five days, and communicated to his allies in Cuba that he would arrive on the night of November 30th. The rebels in Cuba were to create diversionary attacks on the 30th to cover his arrival. The government learned of the plot and the Cuban Air Force was watching for the *Granma*. Castro's insurgents entered Cuban waters in broad daylight on December 2 and were spotted by aircraft.



They were forced to beach in a swampy area several miles short of their intended landing. Most of their arms and equipment had to be abandoned as the men made a hasty exit through the swamp with only what they could carry. Their intention was to make their way into the rugged Sierra Maestra Mountains where they could regroup and contact sympathizers. With the army hot on their trail, most were killed or captured. Fewer than 20 reached the safety of the Sierra Maestra. The handful of rebels who survived

the Granma voyage and reached the mountains included Fidel and his brother Raul, Camilo Cienfuegos and Ernesto "Che" Guevara. They became Castro's trusted inner circle.

Over the next year they recruited more rebels and fought a guerilla war against the Batista regime. By 1958 Batista's control of the countryside was crumbling. Some of his supporters joined the revolutionaries. The United States government withdrew its support, hoping to reach an agreement with Castro as they had with previous Cuban regimes. In December 1958, Batista fled the country and left Havana to Castro.



Fidel Castro was the son of a prosperous sugar cane farmer and enjoyed a privileged lifestyle. He became politically active as a student at the University of Havana in the late 1940's. He was an outspoken critic of government corruption and the domination of Cuba by U.S. business interests, such as the United Fruit Co. After he received his law degree in 1950, he opened a practice in Havana and became a member of a moderate reform party. He planned to run for a seat

in the House of Representatives in the 1952 elections. But a coup by General Fulgencio Batista cancelled the elections.

When legal means to remove Batista and restore ousted president Carlos Prío failed, Castro attempted to start a revolution. With a group of 160 men, he raided the Moncada military barracks on July 26, 1953. Their purpose was to seize arms but the attempt was a total failure. Most of the attackers were killed. Castro and his brother Raul were arrested and sentenced to fifteen years in prison but were released in 1955 as part of a general amnesty. The brothers fled to Mexico where they found many Cuban exiles who wanted to see the end of the Batista regime. They organized the “26th of July Movement” named after the date of the Moncada attack.



The group had some money provided by ousted president Prío but they lacked the means to get their force back to Cuba. At first Castro tried to find a used military aircraft or vessel. Finally he purchased the yacht Granma for \$18,000. The Granma, named for the grandmother of its American owner was run down and in need of repair. It barely made the crossing from Mexico to Cuba. The restored Granma is now

the symbol of the revolution and is on display at the Museum of the Revolution in Havana. The official newspaper of the Cuban Communist Party is Granma, named for the historic vessel.



Cuba became the focal point of cold war tensions in the western hemisphere.

Castro confirmed that he was a Marxist and confiscated the property of foreign investors, mostly American. Other “Banana Republics” seemed ripe, pardon the pun, for revolution. Che Guevara, an Argentinean, was intent on spreading communist revolution throughout Latin America. He was captured and executed in Bolivia (1968).

The U.S. policy was to contain communism on the island. The U.S. imposed an embargo and Castro turned to Soviet Union for aid. The U.S. then backed the anti-communist Bay of Pigs invasion in 1961. That led to the Cuban Missile Crisis (1962) which was about as close as the world has come to nuclear war.



Constructing the model

Granma, the symbol of Castro's revolution, seemed a fitting subject for the Cold War theme contest in March.

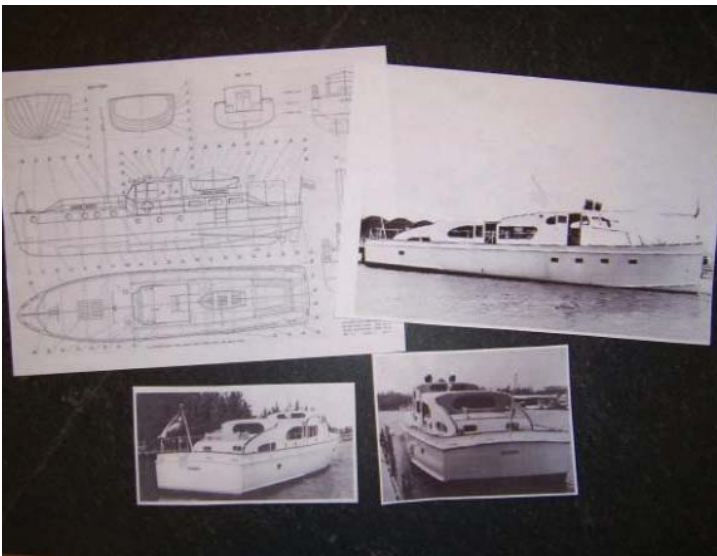

By most accounts, the vessel is a 60' twin diesel yacht. One pretty good side view was found. In 1/72 scale 60' is 10" which was about the size I wanted for the model. So I enlarged the photo with a copier to 10". Another internet search found plans for a model boat with a hull similar to Granma. I downloaded and enlarged those plans to 10" length. I altered the deck line to comport with a superimposed photo of Granma.

The hull was constructed as a 1/16" too short. That was easily fixed

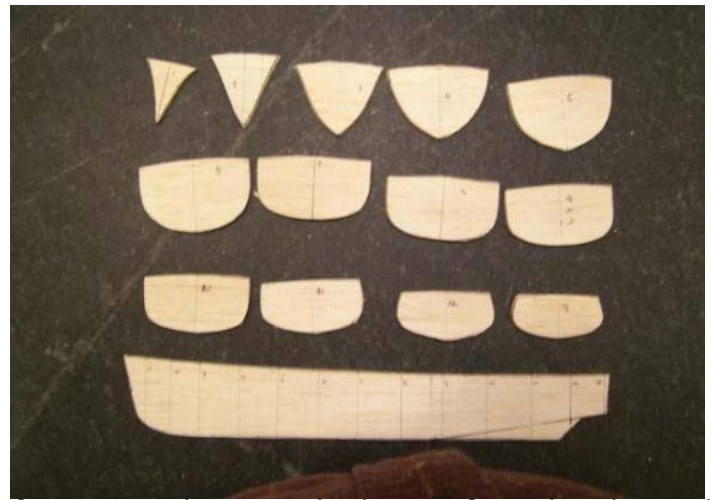

framework consisting of a keel and bulkheads which were covered with 1/16" balsa sheet deck, sides and bottom. I chose to use balsa for this because it is easy to carve and shape. I had made several copies of the plans so I could cut out the patterns for the parts and glue them (glue-stick) directly onto the balsa sheet. I find this method to be faster and less tedious than tracing patterns. After the parts are cut out, the paper can be peeled off.



When I completed assembling the hull and compared it to my photos, the bow didn't look right. This sometimes happens with scratch building. So I glued on a couple more pieces of balsa and recarved the angle of the bow. After rough sanding, the hull now looked to be correct. But when I double checked my dimensions, I found it was now

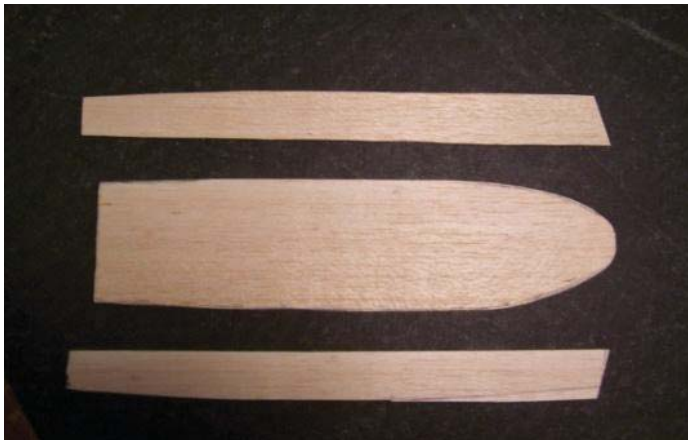

by adding a piece of 1/16" balsa sheet to extend the stern. The hull was completely covered with a thin coat of Bondo auto body filler, resanded and primed. The remaining blemishes were filled with Squadron putty, sanded and primed again. I was now satisfied with the hull form.

I vac-formed .020" styrene sheet over the wooden form to make the finished hull for the model. A trial fit of the sub-assemblies indicated the model was not quite up to Tamiya standards. A bit of trimming, reinforcing, sanding and



filler were required to join everything together properly. In other words, it was a typical vac-form project!

Various small details were made from wire and styrene. Propellers and rudders were filed from sheet metal and soldered to brass rod shafts. Lights were cut from styrene tube with a dab of clear 2-part epoxy glue for lenses. The horn is from a 1/25th scale Model A Ford. Railings are brass rod posts with brass wire lines. The curved mast was cut from sheet styrene with a brass rod cross bar. Flags were cut from sheet metal, and then soldered to brass rod staffs. The metal flag portions were twisted and curled to appear like they were flapping in the breeze. Photos of the actual flags were found on the internet, resized to scale and printed on paper. The paper flags were glued to the metal backers. For a base, I cut a map of Cuba from plywood and added a pair of forked pylons to support the boat. Very clever, I thought. My wife commented, "Oh, it looks like two whales diving into an oil slick." I get no respect!

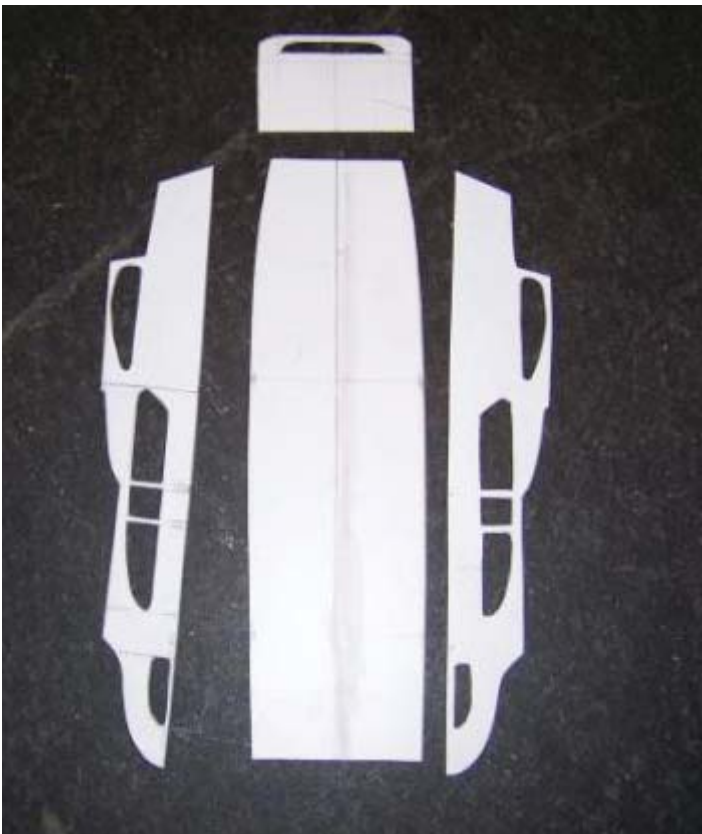



Rushing to complete all the final details the night before the IPMS meeting, I gave everything a spray of dull coat. The next morning I checked out my work. Yikes, it was as shiny as a show car! In my haste I had covered it with gloss coat. When I put my model on the contest table, Bob Bolton commented, "That sure is a shiny paint job." "Yes it is Bob," I replied, "the model represents the *restored* version of the vessel!"



The Cranky Canuck “100% Poutine-free.”

By Jim Bates

Airframe Album 2: The Hawker Sea Fury by Richard A. Franks



Airframe Albums is a new series from Valiant Wings Publishing. While the Airframe & Miniature series is directly designed to appeal to the modeler, the Airframe Album series focuses on the physical aspects of the type and dispenses with most of the modeling content. Being a modeler, I do miss that, but it does not mean the new series does not have merits of its own.

The Sea Fury book is a 98-page soft cover that starts with a preface and is divided into four chapters and four appendices. The preface is a five-page short history of the Sea Fury and its operations by the Fleet Air Arm and others.

Chapter One is titled, “Technical Description,” and is basically a walk around of the details of the Sea Fury, including the cockpit, engine, wings, and stores. Both period and restoration photos are combined with drawings from the Flight Manual to tell the story of the Sea Fury’s airframe and systems. I do wish the photos and drawings were printed in a larger size; often there are five or six to a page, but they are well printed and clear. I especially appreciated the sections of the Flight Manual, as they do a great job of explaining what you are looking at in the photos.

Chapter Two, “Evolution of the Airframe,” uses aircraft drawings and photos to illustrate all the different Sea Fury variants.

Chapter Three, “Camouflage and Markings,” discusses all of the Sea Fury operators and includes a good three-page summary of the Royal Canadian Schemes applied to the Sea Fury and well as six pages of colour profiles of Sea Fury schemes.

The final chapter deals with Sea Fury survivors and their history and it is, in my opinion, the only misstep in the book. This information is not quite complete. Argonaut, a Sea Fury that carries the ID of an ex-RCN aircraft, is not listed, and the listing was out of date almost

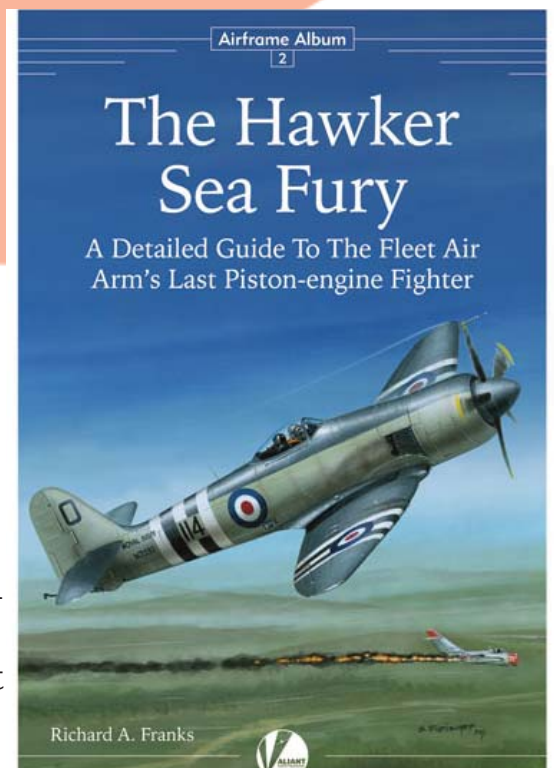

immediately after it was published. In addition, as the chapter says, there is much confusion as to the actual IDs of many of these aircraft. Often the Iraqi Sea Furys, which make up much of the airworthy survivors, were sold as kits and were built up of parts of many different aircraft.

Three of the four appendices cover the modeling content with a list of kits, decals, and accessories, while the final appendix is a bibliography.

Overall this book is an excellent introduction to the Sea Fury and is highly recommended to both modelers and aircraft enthusiasts. It can be purchased directly from Valiant Wings at <http://www.valiant-wings.co.uk>.

Many thanks to Valiant Wings Publishing for the review copy.



You Asked For It.

Randy Fuller
MMCL/Eastern Bloc
Member-at-Large

Modeling

Anywhere?

As I sit here contemplating where my next margarita is coming from, it dawned on me that vacation is supposed to be a time to relax, and while some of us may not really “relax” while modeling, it is a hobby where you can, sometimes, just let your mind wander and sometimes wonderful things do happen!

While browsing the social media sites, I see a number of photos of work benches from my

fellow modelers. My own is quite elaborate and stocked with more plastic and paint than should be allowed by law, but I have a portable “workshop”, too. It’s a simple Plano tackle box with three fold-out trays and a deep case that will hold a model or two easily. The trays have compartments to hold my basic needs: sanding sticks, X-acto knife, tweezers, brushes, etc... All neatly organized for quick access.

I have a few sheets of foam rubber in the case to help cushion the models from moving too much, and I have not have any serious damage in all the “roadtrips” I’ve taken this box with me. I’ve rescribed an A-10 fuselage, added putty zimmeritt to a Tiger I, and even painted figures while on vacation, or working on the road. And while I may not spend every day working on a kit while out, I manage to find a few minutes here and there to glue a couple of parts together, or paint some details, or actually test fit and adjust parts!



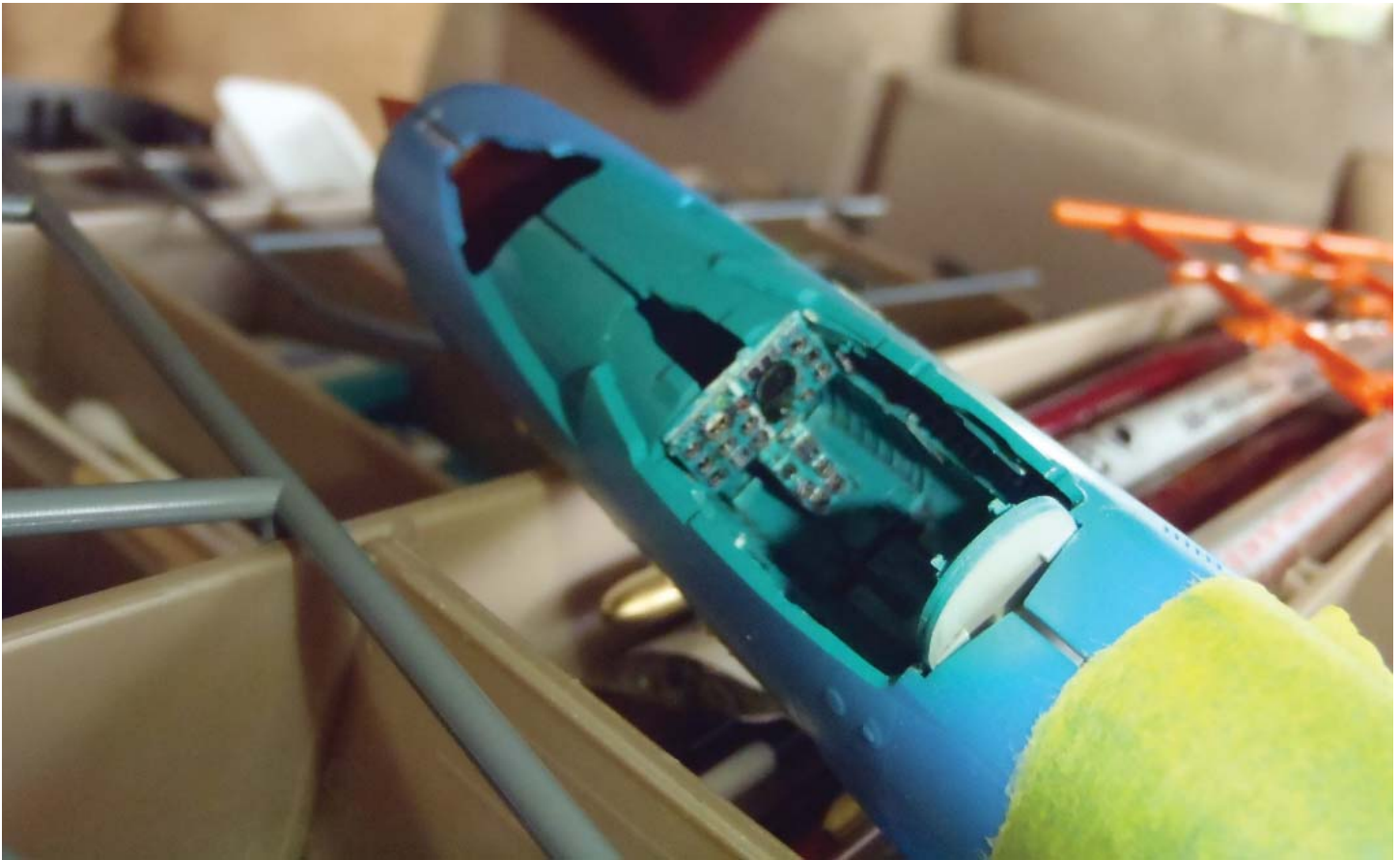

I will pack the box for special projects, too. Pick out paint that I will probably need, maybe throw in some pigments or washes. Whatever I think I might use. This does help me focus on the project and plan ahead. Of course, this is not an airline-friendly piece of luggage - too much liquid and sharp things, and I don't trust the baggage crew to keep it upright and handled gently, so this is only for road trips. So if you are planning an airline ride and want to build, think about how to pack to survive the flight and what you can safely carry onboard without getting TSA in a tizzy.

Model building is one of those hobbies that you can take with you, and I recommend that you should. You don't always need a big, well-lit work bench, or 500 bottles of paint, or any of the countless other pieces,

parts and tools that we all have on or about our workbenches. The talent is in your hands. While you may not be able to lay down a perfect metal finish in a hotel room or at the beach, you *can* build something!

I find I actually do relax modeling on the road! I tend to work slower than at my bench - maybe to make the time away from home go faster, or that I can focus on one project rather than the 10 or 20 (!) I have at home. Either way, I can make progress on my projects, and really just relax and enjoy the process of building a kit. So when planning your next vacation or if work must send you downrange for a few days, plan to pack something to work on, and try to enjoy the hobby again.

Book review: German Jets of World War II

by Dominique Breffort

Planes and Pilots #17 Published

by Histoire & Collections

90 pgs

ISBN:978-2-35250-224-1

Retail Price \$22.95

Review by D.M. Knights IPMS/USA

17656, IPMS/Canada C6091

One area I've always found interesting is the technologically advanced weapons developed by the Germans at the end of WWII. This book is designed to appeal to just that area of interest. I have actually been (slowly) working on a collection of models of these weapons. The level of technology they demonstrate is just really interesting.

I have several books from this publisher. This book is typical of this publisher. It is a softcover book printed on high quality paper. The photographs reproduced in the book are of high quality. One of the main attractions of the series is the very nice camouflage and markings illustrations that these books contain. The aircraft covered by this book are the Me-262, the Ar-234, the Me-163 and the He-162. Each section focuses on a particular aircraft, starting with a brief history of its development followed by a brief history of the aircraft's operational career in the closing year or two of the war. After the text in each section are multiple pages of color sideview illustrations of the subject aircraft. For the Me-262 this color sideview section runs

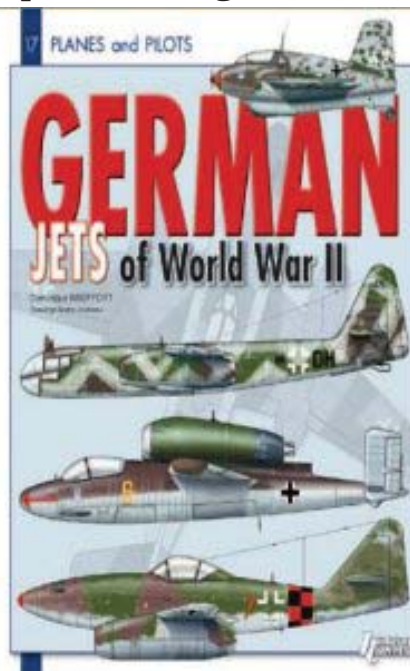

24 pages and covers aircraft from the early prototypes to the final combat aircraft. For the He-162, which saw almost no operational service, there are 10 pages of illustrations. The illustrations are generally left side views and are very attractively done. Each section contains some illustrations of aircraft markings

and camouflage that I have never seen before. Also, each section also has a couple of illustrations of the aircraft in Allied markings after the war. In addition for each aircraft there are one or two illustrations of a typical top view camouflage carried by these particular aircraft. For a modeler looking for inspiration, the illustrations in this book should provide plenty.

The publisher of the book is French and I suspect that the author's first language is French and the text appears to have been translated from French. It is a good translation, with only a few syntax errors making the reader aware of the language translation. The author/publisher does make a few mistakes/typos. These are things like citing the wrong year (1945 instead of 1944) or translating Jagdgeschwader as fighter squadron rather than fighter wing. However, these few errors, while sometimes jarring to read, don't really provide much of an impediment to enjoying the book. My one issue

with this book, as well as a lot of books and magazines lately, is the price. The retail price of this book is almost \$23, which frankly is just part of the trend of higher and higher book prices. Given the advances in publishing and printing technology, I'd have thought that we'd have seen prices drop. However, that hasn't seemed to be the case. In any event, I was able to pick the book up new off Amazon.com for \$16. For that price, the book is worth it. If this is in your area of interest, you should pick it up.



Identify this vehicle!

President's Page

By Stu Cox

Greetings hot and sweltering MMCL members!

Well, it's not as bad as last year....but...hey, it's summer!

So, that means that our August tradition will be in effect for our upcoming MMCL Club Meeting.

As we have done the past few years, we will have a club dinner at a local Louisville eating establishment.

The date of this event will **NOT** be third Thursday (August 15), but will be **Thursday August 22nd (4th Thursday)**. This is a change, as our dinner venue can guarantee us our own private room and dining accommodations on this date. **There will NOT be a regular club meeting at the KYANA building on Thursday, August 15th. This will be our monthly meeting. Our dinner meeting will be at CHAMPPS AMERICANA at 6:00PM (or as soon as you can make it).**

The address is: 302 Bullit Lane, right behind Kohl's Department Store and Oxmoor Mall.

Here is the link to their site so you can check out the menu!

<http://www.champps.com/restaurantinfo.aspx?location=champps-louisville>

The cost of dinner is the responsibility of each club member!

This is a great chance to get together for good discussion with your model club friends.

And, bring your spouse, significant other or if you dare, the rest of the family. Some of our members have made this a family affair in the past. In the meantime, come on out on Saturdays for the Workshop.

Financial Report

By ALEX RESTREPO

July 2013 PNC Bank

Starting Cash Balance:		\$5,188.69
Cash Receipts	Date	
Workshop fees	7/2/2013	\$65.00
Workshop fees	7/8/2013	\$50.00
Workshop fees	7/16/2013	\$40.00
Workshop fees	7/22/2013	\$60.00
Workshop fees	7/31/2013	\$30.00
Raffle	7/23/2013	\$77.00
Recycling	7/23/2013	\$24.00
TOTAL RECEIPTS		\$346.00
Cash Or Debit Expenses:	Date	
Check # 7027 (E) KYANNA Rent	7/8/2013	(250.00)
Check # 1056 CO2 bottle (Welding Therepy)		(17.61)
TOTAL EXPENSES		(\$267.61)
NET Monthly Increase(Decrease):		\$78.39
ENDING CASH BALANCE:	July 2013	\$5,267.08

2013
IPMS/Louisville
Invitational
Contest



May 18, 2013

9 a.m. to 3:30 p.m.

3821 Hunsinger Ln,
Louisville, KY
40220

The Battle of Kursk

70th Anniversary

Entry fee: \$10(\$8 for IPMS/USA members with card) which includes the first two models, \$1 per model after the second.
Juniors: (under 18) Flat \$5. General admission: \$2

Show Contact information:
Dr. Terry Hill
thill35434@aol.com
502-544-6383

www.MMCL.org

Military Modelers of Louisville Membership Form 2013

Name: _____

Address: _____

City: _____ ST: _____ Zip: _____

Phone: _____ E-mail: _____

Birth Date: _____ Year Joined Club: _____

Would you like to receive your newsletter by e-mail? The e-mail version of Tactical Notes is in full color and is sent using the PDF format: Yes _____ No _____

Do you give MMCL permission to place your contact information on the club website: Yes _____ No _____

What are the advantages of membership to the Military Modelers Club of Louisville?

- Monthly meetings held on the third Thursday of the month at the club workshop located at 3821 Hunsinger Lane in Louisville KY.
- A monthly subscription to the official newsletter of the Military Modelers Club of Louisville, Tactical Notes. Tactical Notes contains kit reviews, editorials and modeling techniques.
- The Club Workshop. MMCL has its own club workshop. This is a great place for modelers to build kits and have a good time. The club provides tables, work lights and various tools. We also have quarterly all night model building sessions at this location.
- Quarterly in house model contests with prizes.
- Monthly model kit raffle.
- Annual club cookout.

All of this and more is included in your yearly \$10.00 membership (junior \$5.00) dues.

Please complete all information above and forward your check made out to MMCL for \$10.00 to:

Stu Cox, President
4100 WIMPOLE ROAD
LOUISVILLE, KY 40218
502-499-6618
COX40218@BELLSOUTH.NET

Please visit us on the web at WWW.MMCL.ORG

PD DT _____

September 2013

Tactical Notes

Dennis Sparks returns
with a DC-3

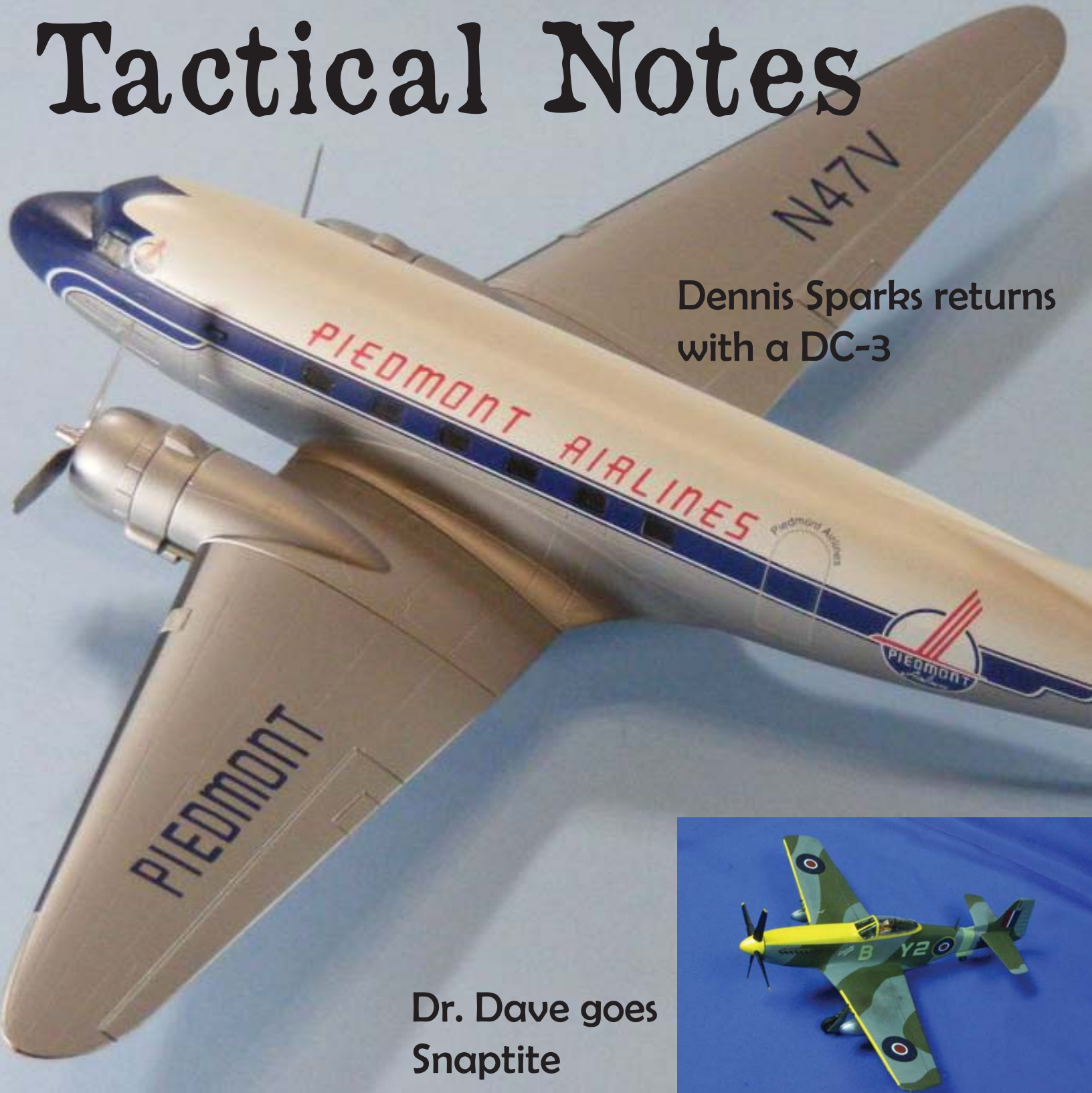

Dr. Dave goes
Snaptite

Next meeting: FRIDAY, September 20th, 6:00 p.m.
FRIDAY NIGHT FIGHT!!!!

2012 and 2013 Region 4 Newsletter of the Year!

To contact MMCL:

President:

Stu "Southwest" Cox

Email: Scox2010@gmail.com

Vice President:

Dr. Terry "United" Hill

Email: Thill35434@aol.com

Secretary:

David Knights

Email: LOULAW@AOL.COM

Member at Large:

Randy "Delta" Fuller

Email: Glusnffr@aol.com

Treasurer:

Alex "Lufthansa" Restrepo

Email: scox6618@bellsouth.net

Webmangler:

Mike "American" Nofsinger

Email: Mnofsinger@insightbb.com

"**Tactical Notes**" is the Newsletter of the Military Modelers Club of Louisville, Inc. We appreciate your taking the time to read this little newsletter. We'd appreciate it even more if you would write something. **Yes, I am talking to you!**

Cover Photos:

Editor's Note

Welcome to the fall modeling season MMCL'ers. Our last meeting was our end of summer dinner at Champps Americana. We had a good turnout with a number of the "better halves" showing up to class the meeting up.

The fall contest season is upon us. Dr. Hill and Rich Guetig have already attended the St. Louis contest. A full report will appear in the next issue. Huntsville and Cincinnati are coming up.

The fall also brings new model releases. Brian's shop has been getting new product in on a near daily basis. Brian invites you to stop on by and see what is new.

This month's meeting is a quarterly Friday Night Fight. It is on Friday, September 20th. I hope that you will be able to attend.

Speaking of building, I continue to see a lot of building going on. How about taking a photo or two and doing an article for the newsletter. Thanks to Jim, Randy, Dr. Dave and Dennis for the articles in this issue. The last few issues have had more pages and I hope to keep this trend up, but it will require contributions. I've also been getting permission to run some interesting articles from other newsletters. I hope you enjoy seeing these articles that I think deserve a wider distribution.

Keep modeling and I'll see you on the 20th.

Modeling Piedmont Airlines DC3 N47V “Bluegrass Pace- maker”

By Dennis Sparks MMCL Eastern Bloc

Seen now from a distance of some 75 years, it's difficult to realize the magnitude of the revolution to the airline industry that was brought about by the introduction of the Douglas DC3. Introduced into service by American Airlines in August of 1936, it was regarded as the first commercial airliner that was capable of operating at a profit while carrying only passengers, without the need of federal airmail contracts to provide additional income.

And while admittedly the industry was quite small by today's standards, US passenger volume increased dramatically after the arrival of the DC3. In less than three years, passenger volume was five times greater than it had been in 1935. It's often claimed that before the end of the decade about 95% of all airliner passengers in the US were being flown in DC3s. In addition to dominating the US market, DC3s were also purchased by many foreign airlines, and as a result the type was carrying a large percentage of the entire world's airline passengers before the start of WWII in Europe.

Production of the civilian DC3 prematurely and permanently ended due to the war, but more than 10,000 of the C47 military cargo version were built for the US and Allied air forces during WWII. After the war, large numbers of these were declared to be

surplus to military requirements and so were sold to the civilian market at fire sale prices.

Many of these were quickly refurbished and resumed their original role, where they provided a badly needed boost to the post war commercial airline business. Formed in early 1948, Piedmont Airlines of WinstonSalem, North Carolina flew 22 of these converted C47s for about fifteen years before transitioning to newer types.

The aircraft that was to later become N47V was built at the Douglas plant at Long Beach, California in mid1944 as a C47A90DL. It was accepted by the USAAF on 07 June, and was given the serial number 4316005. (The “43” in the s/n indicates that the money to purchase the aircraft had been allocated in the fiscal 1943 federal budget, and does not necessarily represent the actual date of construction.)

It was quickly assigned to the Alaska Wing of the USAAF's Air Transport Command, and spent the remainder of the war flying cargo in and out of Elmendorf Army Air Field in Alaska. Postwar, it was shuffled around a bit from Montana to Memphis before it was declared surplus and sold by the Reconstruction Finance Corporation in July 1946. It was operated by Lone Star Cargo Airlines as N79029 for a short time before it was refurbished to bring it up to DC3C standards and sold to Piedmont in early 1948. Commercial passenger service began at Lexington's Bluegrass Field when DC3s operated by both Delta and



Eastern Airlines arrived only a few hours apart on 13 October 1946. Piedmont became the third airline to offer regularly scheduled service shortly after their inaugural flight passed through Lexington on its way from WinstonSalem to Cincinnati on 20 February 1948.

Piedmont began operations with all of their aircraft wearing a somewhat spartan all natural metal finish before adopting an attractive new scheme in 1953, painting the top of the fuselage gloss white and adding the blue window stripe. At the same time, the airline applied for new FAA registrations for their entire fleet to give them consecutive numbers. N79029 became N47V and was named "Bluegrass Pacemaker". After more than a dozen years of service, likely flying every Piedmont route at some point in its career, N47V was retired in October 1961.

N47V was sent to Charlotte Aircraft Corporation in North Carolina for refurbishment and was then sold to the Spanish Air Force. Sadly, it

was to serve for only a few months as T.339 before being destroyed in a fatal crash at Jerez de la Frontera, Spain on 10 April 1962.

Building the model

To the best of my knowledge, there have been three 1/72nd scale kits of the C47/DC3 offered by mainstream manufacturers. Airfix released one in the 1960s, followed by ones from both ESCI and Italeri in the early 1970s. The Airfix kit was festooned with rivets and featured ill-fitting separate control surfaces. I built one years ago, so that's proof enough that it wasn't unbuildable, but neither was it going to be a champion without a lot more TLC than I was willing or able to provide. I've read somewhere that the mold had finally been retired as worn out, and that ironically, the most recent Airfix C47 offering (c.2006) was in fact a reboxing of the Italeri kit. I've never built the ESCI kit, although I have a couple buried deep somewhere in the Sparks collection.

There was an online discussion recently as to whether the ESCI kit was evolved from the Italeri kit or vice versa, but it's a reasonably moot point now as ESCI hasn't been around for quite a while.

However, the Italeri kit is still readily available. It's as hard to kill as a May mosquito, having been reissued many times under its original label, plus the aforementioned Airfix label, as well as flying the flags of both Testors and Revell on other occasions. The one that I used for this model is Italeri's kit #127.

Interestingly, the box top is emblazoned with a logo proclaiming that the kit is a "Boeing Officially Licensed Product". The legal rationale for this is that Douglas had merged with McDonnell in 1967, and thirty years later McDonnell-Douglas merged with Boeing, which somehow retroactively makes the DC-3 a Boeing product?

No matter which company released it, all of the Italeri kits featured the large side cargo door of

a C47, but with an optional insert for the smaller passenger door. The decal sheets offered with the many releases have offered both USAAF and RAF military markings, plus Eastern, Western, and Pan American Airlines and probably a few that I've forgotten. The kit is definitely no longer state of the art, with engraved panel lines that are far too large and that seem distinctly odd. The most prominent ones on the fuselage run only fore and aft, while the ones on the wing make it look as if it had somehow been quilted.

Assembling the fuselage halves, I quickly noticed rather large sink marks on the top where the alignment pins were located. Sanding the bejezus out of it to eliminate these serendipitously greatly reduced the fuselage's panel lines as well. As I was uncertain if I would be leaving the windows clear or cover them with silver decal, I added the kit's cockpit floor and rear wall, plus the pilot seats and control columns. The kit provides only the C47 style floor and



bench seats along the sides, so I left all of this out, leaving the passenger cabin bare.

I cemented the tops of the left and right wings to the single piece lower surface and attached the assembly to the fuselage. Other reviewers had noted some fit problems at the wing roots, but mine went together okay. After adding the horizontal tail surfaces, engine nacelles and carburetor air intakes to complete the basic airframe, I brushed a thick layer of Tamiya's version of Mr. Surfacer into all of the remaining panel lines and then wet sanded with 600 grit sandpaper to make the panel lines less noticeable.

After a final light wet sanding over the entire model, I masked off the windows and the lower fuselage in a line just below the windows, and then shot the upper half of the fuselage with a spray can of Tamiya's TS26 Pure White gloss lacquer. The intent here was to have nice coat of white in the area where the blue window stripe decal would later be applied. I didn't want the white-to-silver transition to be situated under the decal sheet on the chance that the stripe would be translucent.

Letting the paint dry for a few days, I then covered all of the white area with Tamiya masking tape and painted the rest of the aircraft with Tamiya's AS12 spray can of Bare Metal Silver.

The rubber deicer boots on the leading edges of the flying surfaces were represented by using strips of Microscale's black decal trim sheet that were cut to fit. The easy way to

do this is to use two pieces for each boot and overlap them as needed. Cut and apply a strip that's a bit wider than is needed to cover the lower surface of the boot, taking care to align the decal with the demarcation line for the rear edge of the boot, and then wrapping it up and over the leading edge. After it's dried, a similar second strip is used to cover the upper surface of the boot, overlapping the first decal as needed. Judicious use of a small amount of Solvaset makes the overlap almost impossible to detect. This is much easier than masking and airbrushing the boots, and gives a much sharper and straighter line than trying to paint them on with a brush.

The Piedmont livery is from the Flying Colors decal company. It was apparently their first 1/72nd scale sheet, as it's their number FC72-001, dating from 1999, only a year after the company was founded. But as of a few months ago at least, it's still available via their website. Registration numbers and names for all of Piedmont's DC-3s are provided on the sheet. The decals were very crisply printed, thin but sufficiently sturdy and were applied with minimal problems. Wrapping the decal around the compound curve of the nose required making a few slices to allow the decal to overlap a bit, but everything snuggled down nicely without any decal softening agents. Additional blue decal is provided on the sheet if needed, and the color is closely matched by Testors 1111 Dark Blue (the small square bottle).

This model was built in 2012 at the

request of my friend Bob Cole. After serving as a B-25 crew chief during WWII, Bob was a long-time employee of both Piedmont and later with Eastern Airlines at Bluegrass Field. After his retirement, he served as a docent at the Aviation Museum of Kentucky from the day it opened in 1995 until he passed away earlier this year.

I'd also been building a second DC-3 for him in the markings of Eastern Airlines, and I finished it up a few weeks later. The Delta Airline Pilots Association provided him with a die cast 1/72nd scale model of a DC3 wearing the markings of Delta Airlines and Bob added all three to an exhibit at the museum about the early history of aviation in Lexington.



MMCL Summer Dinner

You Asked For It.

Randy Fuller
MMCL/Eastern Bloc
Member-at-Large



The Art of War: The Smackdown.

Admit it, you are competitive. You might want to think you are not, but trust me, you are. Maybe not to the same degree as your fellow MMCL brethren, but we all like to win. Why do you enter your models in contests? Oh yeah, just to show them. C'mon, no one would pay \$5 for the first entry and \$2 for each additional entry if they just wanted to put them on a table for "ooohs and ahhhs". You secretly hope to walk out with a trophy.

But trophies and medals are OK. They start to take up room and get dusty, and in the end what do you really remember about your victory? Faceless, nameless other modelers? HA! I say! Let's cut right to it – you want to stare your opponent in the eyes and taste sweet victory! Which is sweeter when you see the vanquished humbled at your feet!! Viva la revolución!! Taste my blade you...oh, sorry. Right. Back to it.

Enter the smackdown - a real competition in my humble opinion. One subject, one era or battle, maybe one kit. Two (or more) men enter, one man leaves (victorious). For me, the real challenge is putting your skills to the test

against your fellow modelers. Perhaps you get out of your comfort zone and build an aircraft (gasp!), or a figure (Argh!), or even a SciFi or civilian automobile (The horror!!). Comparing your skills in construction and finishing to your peers – now that’s satisfying. You might even learn a thing or two along the way. And it is based purely on aesthetics – not all the minutia of contest judging – ugh! what a pain. (Did you ever wonder why it takes so long to judge a show?) Battle with your peers; judged by your peers. Now that’s a contest!!

So what makes a good Smackdown? Well first, you most mock, ridicule, and torment at least one fellow MMCLer. The Uncle is typical smack-bait. (Sorry, John) Second, define your skill (or lack thereof) to attack – older Monogram kits, Out-Of-the-Box/No aftermarket, superdetailed, WWI, WWII, Tiger I in 35th, F-15 in 72nd, you get the idea. Third, set the date. This is also a critical choice, as it can define a slow or fast build, which may or may not work to your advantage!

I’ve been in more smackdowns that I can remember. I won some and I lost some. I’ve built kits I would never even think about otherwise. My favorites are ones where it is one particular kit, out of the box, but built as you like. Then the battle begins. I don’t really like a lot of latitude in a smackdown as you can get such a broad scope of entries; it’s not always fair to compare them to each other. I mean if someone superdetails an F-14 and it is somehow in comparison to an Abrams tank OOB (maybe it’s

a Desert Storm smackdown, Sock!) that just may not be a fair contest. So I would keep a laser-like focus on the subject and limit the kits so that the skill of the modeler will be tested. Besides how cool would it be to get 10 or 15 of the same subject lined up on the tables one Thursday night?! Now we have the Koko DML/Dragon tank smackdown this month, and the NATO MBT next month, followed by a Ki-44 in January. Next year is wide open boys! So who wants to call the next big battle royale? Anyone for a 72nd scale sub? How about a 350th Arleigh Burke? 32nd Tomcat? 48th Eagle? Formula 1 racer? Maybe a Star Trek Enterprise, or a Wingnut Wings bird, or one of my beloved SF3D/MaK kits? I got dozens of ideas and hundreds of kits, but I want to hear from my clubmates. Unless you want me to call someone out...scared yet?



MMCL Summer Dinner

The Cranky Canuck

By Jim Bates

British Phantoms - The Phantom FG Mk.1 and FGR Mk.2 in Royal Navy and RAF Service by Patrick Martin

One of the early kits that remains in my memory is the Matchbox British Phantom. As a young boy, nothing seemed cooler, and I've had a slight obsession with the Spey-engined Phantom ever since. With such wonderful memories, what a great treat it was to open Patrick Martin's new book. The 160-page hardcover has everything one needs on the topic. Chapters include design and development, operational use, colours and markings, and squadron data. Every page is well illustrated with many photos, most in colour, with some black and white shots interspersed. Also included among the text are colour side-view drawings of some of the interesting markings that the Spey Phantoms have carried as well as an appendix illustrating the FG.1 and FGR.2 camouflage schemes with four view drawings.

Carrier operations with the Fleet Air Arm, and land based reconnaissance, strike, and finally air defense use by the RAF of the F-4 are covered, including a short segment on the Phantoms that participated in the 1969 Daily Mail Atlantic race. While the book is more a general history of the type and not a detail oriented modelers book, detail of interest to modelers can be observed in many of the photos.

About the only flaw I can see is that I need to wait for the second book that will cover the service after 1979. Highly recommended to both the F-4 modeler and the Phantom fan.

Modeling Airliners by Aaron Skinner

Review by Jim Bates

Airliners are something that I've always wanted to build, but for which I never really found the time, nor have I, shockingly, ever purchased any kits. However, it appears to be the golden age of airline modeling with new kits being

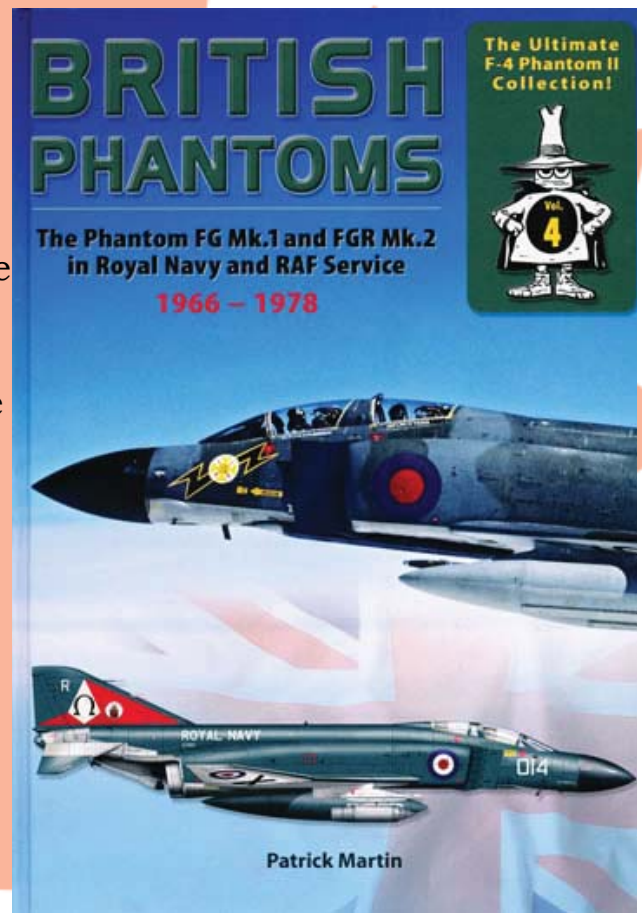

released every month, so I decided to order this book from Amazon and see what it had to offer. (That, and I'm kind of addicted to modeling books.) My order was not without some trepidation, as Mr. Skinner is a Fine Scale Modeler Editor and FSM has reached a level of simplicity to be almost useless. Vapid articles with no detail and the most basic tips and techniques pummeled into the ground issue after issue.

However, I should not have been worried; this is a nice book. It is an 80 page softcover book with colour throughout. Chapters include construction, painting, decals, conversions, detailing, weathering, and of course a model gallery. All the models are very well done, and each chapter is well illustrated. What it does not do is skimp

on words, and there are clear, but not overly simplified, descriptions of each step and technique. Mr. Skinner's technique to fill windows is both backwards of what I would have tried and quite genius. Shockingly for 2013, there is even a vacuform build! Everything you need to know to build airliners is here. Sure, all the basics are covered, but there is enough meat here that even the experienced modeler will pick up a few tips and techniques. Very well done. Now to get a DC-8 and some Canadian Pacific decals...

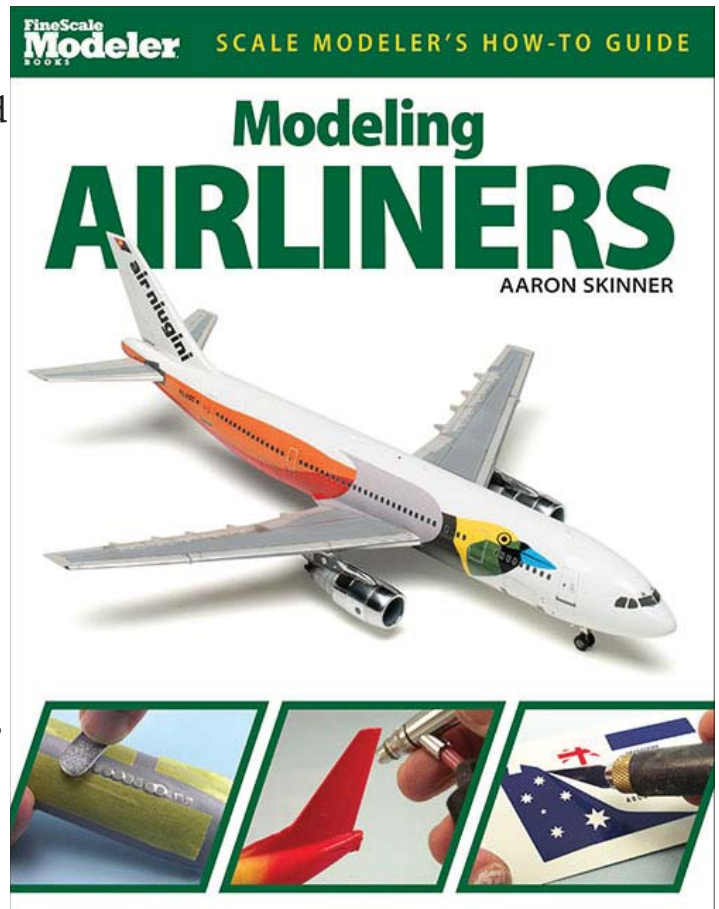

Revell Snaptite "1/72" P51D as Mustang IV, RACAF 442 Sqn, 1945

By Dr. David Geldmacher

The IPMS Birmingham Phantom Phlashers "President's Challenge Build" theme for Summer 2013 was "SnapTite." Models were required to be finished per IPMS Out of the Box Rules, but removing the SnapTite features to use glue/cement was permitted. The OOB requirement prevented me from pursuing my usual interests in reconnaissance or special missions variants of the available SnapTite kits in 1/72. I considered the old Revell YF-23 in a What-If scheme, maybe as an Aggressor, but none were on the shelves locally. If a SnapTite Spitfire IX were available in 1/72, I could have managed one of

the late war pink Tac Recce versions, but alas only the Mk.I is out there. The same OOB problem exists for any of the interesting reconnaissance variants of the Revell SnapTite P-51D that's readily available.

So, if I can't go with a mission-driven build, it would have to be color and markings. Coming from a SnapTite meant it wouldn't be in natural metal. I could go with a what-if scheme, perhaps a WW2 Atlantic ASW version. Hmm...

Well, one of the most interesting of all Mustang schemes, and something that would look very different on a club contest table in Alabama (for sure) is the RCAF 442 Sqn pattern from around V-E day. These had the unusual "Loop" variation of the RAF day fighter scheme and bore a brilliant ID yellow "antiglare" panel and canopy frame. The squadron codes were arrayed unusually and trimmed with a fine yellow outline. Now, off to find decals. My friend Jim Bates, who writes the "A Scale Canadian" blog from the frozen wastes of Ohio offered me a spare set of decals for that color scheme from Arrow Graphics (copyright date 1994). Jim had heard rumors that these might be somewhat overscale, but more on that later.

The Revell SnapTite Mustang kit is circa 1974 (it says so in big raised letters right on the starboard flap undersurface). It is now available in a pre-painted version, listed as 1/72 scale, and prominently features on the shelves of mainstream craft/

hobby retailers like Michaels. Upon measuring, the wingspan scales out about 10% oversize, or about 1/65 scale. There are 21 parts plus the clear canopy. The canopy shape is distorted to facilitate snap-together assembly and the sliding portion of the canopy frame is molded as part of the fuselage. Panel lines are prominently raised throughout, but there are no rivets. There is no interior detail except for a nicely formed pilot. Neither the radiator intake nor radiator outlet flap is molded with any opening. Not many folks here in Alabama are likely to recognize that the engine breather panel on the nose is "perforated" (represented by raised lumps) instead of the louvered RCAF version.

So, on to the build. First, I stripped the preprinted markings from the wings and fuselage. I repainted the pilot to RCAF /RAF standards and painted the interior sidewalls black. The interior shelf with pilot was positioned and the



fuselage halves were assembled after cutting off the snap lugs. Fit was generally poor. The wings come as a single lower piece and the upper halves mate no more poorly with the fuselage than any vintage Airfix kit. I used a styrene shim in the gap of the port wing to get the dihedral even. When I removed the snap pins on the wing, I inadvertently altered the wing thickness. This resulted in the flaps and ailerons, which are molded into the upper wing halves, standing well proud of the wing lower surface. The tailplane passes through a slot in the fuselage halves with plenty of space to spare. A lot of red auto filler putty and many rounds of putty-sand-repeat were needed. The underside wing to fuselage seam proved unfixable, due both to the changed wing thickness and its location adjacent to the radiator scoop. While I was doing all that sanding, I decided to take off all the manufacturers copyright lettering on the flap, too. Final seam filling involved Mr. Dissolved Putty in many places and thick CA glue where flexing was a problem along the wing seam. The canopy to fuselage joint was atrocious. I thinned the snap lugs and hand painted the coaming and deck flat black. After a dip in Future, I blackened the lower edge of the canopy with a paint marker and tacked the clear part in place with CA. I carefully masked the canopy. The unusual size and shape prevented me from using any precut masks, so I did it the old fashioned way. Then I used thick CA to try to fill the gaps, this was followed by Mr. Dissolved

putty and plenty of sanding to smooth the joint. After all the sanding, it was no longer evident that there was supposed to be a sliding canopy hood. I therefore used tape to define the outline of the metal canopy section and doubled up its thickness. I added Mr. Surfacer 500 in multiple layers to reach the level of the tape and then sanded it until I was back down to the tape. Removing the tape left me with a subtle, though nowhere near perfect, canopy frame.

I then primed the airframe with Floquil enamel primer and addressed a few more small seam cracks and sinkmarks. Next a Tamiya flat white undercoat went on along the antiglare section and the wing leading edges. A coat of Tamiya Flat Yellow stood in for UK ID yellow in the same spots. After that was masked, I shot Tamiya Sky for the fuselage ID band. Once the Sky band was masked, Life Color FS36270/Medium Sea Grey went on all undersurfaces. I used Tamiya



Ocean Grey for the primary upper color, which was then masked for the Tamiya Dark Green disruptive pattern.

As a dyed-in-the-wool enamel user trying to make the switch to acrylics, this is the first kit where I've used Tamiya acrylics as my primary paint. I have to say I love them, and had no problems at all. I think they will be my first choice from here on out. The drop tanks were sprayed PollyScale Aluminum (which did not go as well) and the pylons touched up by brush with the Life Color Medium Sea Grey. Late Mustangs seem to have gone over to zinc chromate in the wheel wells, so I brush painted Tamiya chromate yellow in the spuriously ribbed main gear wells. I touched up the tires with Tamiya NATO black.

Decalling got off to a great start. I chose to begin with the fin flashes because I had plenty of spares if something went wrong. After trimming to correct a minor color registration problem, they went on like a dream. The same was true for the serial



numbers. Things were looking good for the 20 year old decal sheet. The yellow backing circle for the fuselage roundels was quite translucent but would serve OK. Next up, the roundel itself. BAM! It shattered mercilessly

as soon as I started to move it from the paper. Ouch! It's just an RAF roundel though, and I've got plenty of those in stock. Amazingly, not one was the right size to match the yellow backing disk, and none of my yellow ringed C1 roundels was the same size as those on the sheet. I wonder if that size issue, and the rather large "Edmonton Special" personalized script under the port windscreen was the source of concern about the size of the markings.

I quickly coated all of the remaining markings with liquid decal film. I found a couple reasonably sized type C roundels for the wing upper surface to give me a spare fuselage roundel and figured I was safe. I was wrong. Even with the liquid film, I had recurring problems

with markings cracking around the edges and them curling up as they dried. I sustained several more utter failures but eventually all the required markings went on, but all four wing roundels are from other sources. I decided to sharpen the masked edges of the wing ID panels

with thin strips of yellow decal. This helped their appearance considerably. Future was necessary to hold most of the decals down tightly.

In the end, the markings are messy but acceptable from the 3 foot

intended viewing distance I planned for them. Final assembly involved adding the landing gear and drop tanks. Amazingly, the molded-in fuselage aerial mast remained intact throughout the entire build

In summary this was a tough build. I didn't much care for the kit and my much-desired markings turned into a thrash. However, I was a good citizen, played along with the club's rules, and brought an attention-getting model to the table. As an aside, the other SnapTite Mustang on display was the 1/48 Pegasus kit, also done with colorful markings by club member John Hassard.



September 21 (this weekend). The **ACTUAL CINCINNATI MODEL CONTEST AND SHOW DATE IS SATURDAY, OCTOBER 12th**. So, you have a few more weeks to get some kits and figures wrapped up and ready for the show. We are encouraging a big MMCL turnout for this model show this year! We'll plan to go for the entire day, and enter and participate fully. We also want to talk up our MMCL Invitational show on May 17th, 2014.

President's Page

By Stu Cox

Okay MMCL Members! **This Friday Night, September 20th is FRIDAY NIGHT FIGHTS!**

This is our quarterly modeling workshop and kit swap & sell event, so bring your stash to work with! There will NOT be a regular monthly meeting on Thursday night. Our combination MODELING WORKSHOP, SWAP MEET and All Around Good Time, will be Friday night, 5:00PM until Midnight at our regular KYANA location!

Now, there has been talk of a number of our members possible showing up on Friday the 20th at noon time to start doing some modeling. Rumor has it that if weather permits, some folks might unpack our grills and actually cook up some hot dogs and brats for lunch. This is a lunchtime opportunity. If you think you might be able to make it, go to our MMCL Facebook page and let us know.

I want to correct an upcoming date reported for the Cincinnati IPMS Scale Model show. This was incorrectly reported by IPMS originally as

We will be doing some renovating in our MMCL storage room. Keep your eyes peeled when you come on Saturdays. We are upgrading our air booth and will re-arrange the room for optimal use for painting models. We will need everyone's help in keeping the room organized, and returned to the same clean and organized state that you found it whenever you use it. We may even be looking at adding some additional "painting" workshop evenings now and then in addition to our Saturday Workshop. More to come on that.

We'll be back to regular meeting formats on the Third Thursday of the month for our October and November meeting dates. Then, in December we have our annual club family Christmas dinner planned. We'll take feedback on our recent dinner at CHAMPPS to determine if we want to return there for the December Meeting.

Thanks, and I hope to see you all at Friday Night Fights this upcoming Friday the 20th!

Financial Report

By ALEX RESTREPO

Aug 2013		PNC Bank	
Starting Cash Balance:			\$5,188.69
Cash Receipts	Date		
Workshop fees	8/5/2013		\$80.00
Workshop fees	8/14/2013		\$55.00
Workshop fees	8/19/2013		\$75.00
Workshop fees	8/28/2013		\$20.00
Renewal	8/30/2013		\$10.00
Shirt sales	8/19/2013		\$20.00
	TOTAL RECEIPTS		\$260.00
Cash Or Debit Expenses:	Date		
Check # 7028 (E) KYANNA Rent	8/8/2013		(250.00)
Check # 7030 (E) KFB Insurance	8/19/2013		(257.04)
Check # 1057 IPMS Nationals Award Sponsor	8/21/2013		(85.00)
Check #1059 Shirt Re-order	8/15/2013		(60.00)
	TOTAL EXPENSES		(\$652.04)
NET Monthly Increase(Decrease):			(\$392.04)
ENDING CASH BALANCE:	Aug 2013		\$4,796.65

2014

IPMS/Louisville

Invitational
Contest

May 17, 2014

9 a.m. to 3:30 p.m.

3821 Hunsinger Ln,
Louisville, KY
40220



D-Day

The Invasion of
Normandy

70th Anniversary

Show Contact information:

Dr. Terry Hill

thill35434@aol.com

Vendor Contact

Dave Crouch

dcrou@bellsouth.net

Entry fee: \$10(\$8 for IPMS/USA members with card) which includes the first two models, \$1 per model after the second.
Juniors: (under 18) Flat \$5. General admission: \$2

www.MMCL.org

Military Modelers of Louisville Membership Form 2013

Name: _____

Address: _____

City: _____ ST: _____ Zip: _____

Phone: _____ E-mail: _____

Birth Date: _____ Year Joined Club: _____

Would you like to receive your newsletter by e-mail? The e-mail version of Tactical Notes is in full color and is sent using the PDF format: Yes _____ No _____

Do you give MMCL permission to place your contact information on the club website: Yes _____ No _____

What are the advantages of membership to the Military Modelers Club of Louisville?

- Monthly meetings held on the third Thursday of the month at the club workshop located at 3821 Hunsinger Lane in Louisville KY.
- A monthly subscription to the official newsletter of the Military Modelers Club of Louisville, Tactical Notes. Tactical Notes contains kit reviews, editorials and modeling techniques.
- The Club Workshop. MMCL has its own club workshop. This is a great place for modelers to build kits and have a good time. The club provides tables, work lights and various tools. We also have quarterly all night model building sessions at this location.
- Quarterly in house model contests with prizes.
- Monthly model kit raffle.
- Annual club cookout.

All of this and more is included in your yearly \$10.00 membership (junior \$5.00) dues.

Please complete all information above and forward your check made out to MMCL for \$10.00 to:

Stu Cox, President
4100 WIMPOLE ROAD
LOUISVILLE, KY 40218
502-499-6618
COX40218@BELLSOUTH.NET

Please visit us on the web at WWW.MMCL.ORG

PD DT _____

October/November 2013

Tactical Notes

MMCL rocks the modeling world!

Did you know they use to build airplanes in Canada?

Next meeting: Thursday, November 21st, 2014 7p.m.
Koko's Dragon kit smackdown!

-2012 and 2013 Region 4 Newsletter of the Year!

To contact MMCL:

President:
Stu "Poutine" Cox
Email: Scox2010@gmail.com

Vice President:
Dr. Terry "Canadian Bacon" Hill
Email: Thill35434@aol.com

Secretary:
David Knights
Email: LOULAW@AOL.COM

Member at Large:
Randy "Maple Syrup" Fuller
Email: Glusnffr@aol.com

Treasurer:
Alex "Moosehead" Restrepo
Email: Alexrest@aol.com

Webmanglers:
Mike "Kraft Dinner" Nofsinger
Email: Mnofsinger@insightbb.com

John "Butter Tart" Sachs
Email: J3cubfan@gmail.com

"Tactical Notes" is the Newsletter of the Military Modelers Club of Louisville, Inc. We appreciate your taking the time to read this little newsletter. We'd appreciate it even more if you would write something. **Yes, I am talking to you!**

Cover Photos: MMCL President Stu Cox rockin away at a recent appearance. Photo by Editor David M. Knights

Editor's Note

Welcome to the combined October/November issue of Tactical Notes. I apologize for my failure to get the October issue out on time. Work has been particularly difficult of late and I am afraid to many things came due all at once. Instead of just sending it out late, I decided to combine October and November into a double issue. Here it is at 20 pages. I hope you enjoy it.

The October meeting was awesome. Our webmangler, John Sachs, gave a presentation on the growing MMCL web presence. If you haven't been to WWW.MMCL.ORG lately, you should. Among other things John is slowly getting posted all the back issues of Tactical Notes. Eventually our hope is to have the complete archive dating back to 1982 up for new members to view. Mike Nofsinger and Randy Fuller continue to make sure that MMCL has a Facebook presence. A lot of neat things are going on at the club Facebook page. While I am not a huge Facebook fan, it is worth being on Facebook just to catch the goings-on at the MMCL Facebook page.

I want to thank everyone who has contributed to Tactical Notes over the last year. The issues have grown to the point where now most months the issue is 15-18 pages. I'd like to keep that up, but it requires members to continue to write and submit articles. We've got some great modelers in this club and I'd like to be able to publish more of their work. Please write something.

The fall contest season is in full swing. You'll find several show reports in this issue. I am sure we will have more reports in future issues.

Finally, I am constantly trying to improve the newsletter. If you have suggestions, please let me know. I'll be happy to consider almost any suggestion. I hope to see you all at the November meeting.

2013 OHMS Model Show Report

By Jim Bates

On Saturday September 21, 2013, I had the chance to attend the Oregon Historical Modelers Society Model Show at the Evergreen Aviation and Space Museum in McMinnville, Oregon. Held in the Space Museum building, it was a nice event and probably about equal in size to an average Region 4 show. (The official count was 423 models entered by 103 modelers. The total number of models was up from 359 in 2012.) With a full scale P-51D, Corsair, SR-71, and various space items overlooking the model area, it was a fun venue for a show. There were a decent amount of vendors, with Rare Plane Detective being the most well known, and some great deals. The Evergreen campus is an interesting place: part air and space museum, part water park (with water-slides spiraling downward from the 747 on the roof), and part vineyard, it seems it has something for everyone...including the Spruce Goose!

P.S.: In what may come as a shock to many Region 4 show organizers, the model room stayed open during judging. Oddly, the sky did not fall and the world did not end. Wake up Region 4 clubs! It is a model show; closing the model room during judging and keeping your attendees from looking at the models is ridiculous and needs to change immediately. I don't care what bogus arguments you make to justify having to close the room - there is no good reason for doing so and it's nice to see the west coast clubs being a bit more creative in their thinking.

All following show photos by Jim Bates.



Awesome A-20



TACTICAL NOTES 2

An unusual Avenger conversion

The old Williams Bros. B-10



F-104 in Canadian markings

Here is one you don't see often, a 72nd Boeing YB-9

www.ipmsusa.org



Breda Ba-65

The new Meng F-102



Italian Campini

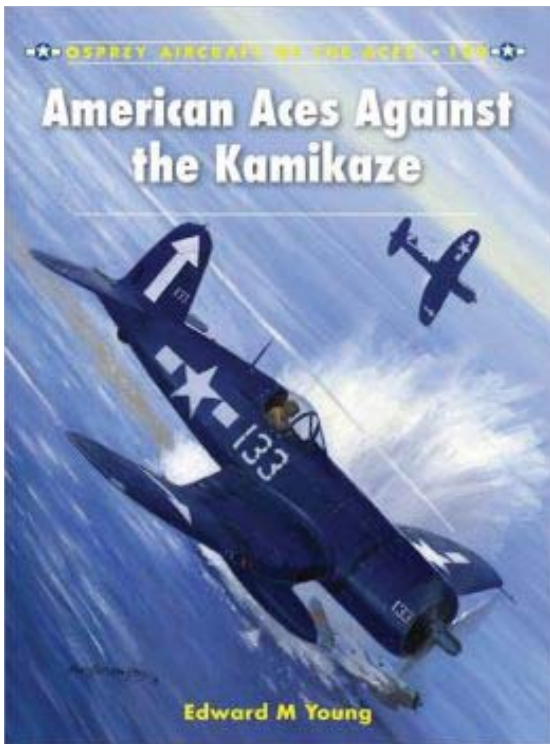

Book review: American Aces against the Kamikaze

Osprey Aircraft of the Aces #109

Author: Edward M. Young

96 pgs

14pgs color illustrations and numerous b&w photos

Review by D.M. Knights IPMS/USA17656 IPMS/Canada C6091

This book covers USN and a few USAAC pilots who claims some or most of their kills against IJN and IJA pilots in late 1944 thru the end of the war in 1945. As the author readily notes, identifying what Japanese aircraft were

kamikazes our escorts for kamikazes, as opposed to simply enemy aircraft on normal attack missions, is difficult if not impossible.

The book is a fairly typical Osprey book. The book is well written without any obvious typos. There are 8 pages of color side views, with 4 illustrations per page for a total of 32 illustrations. The vast majority are, as would be expected from the subject matter, USN aircraft and those are in the overall Gloss Sea Blue (GSB). That personally isn't one of my favorite schemes, however, the authors still managed to come up with some interestingly marked aircraft. There are also a few USAAF aircraft for those who don't fancy doing an aircraft in overall GSB.

If you've got the new 72nd Eduard F6F Hellcat, then this book will be especially meaningful to you. I've already picked out a scheme from the book for one of the Eduard Hellcats that I have in the stash. I got this book off Amazon for about \$13. I think it was well worth the price. I recommend it.

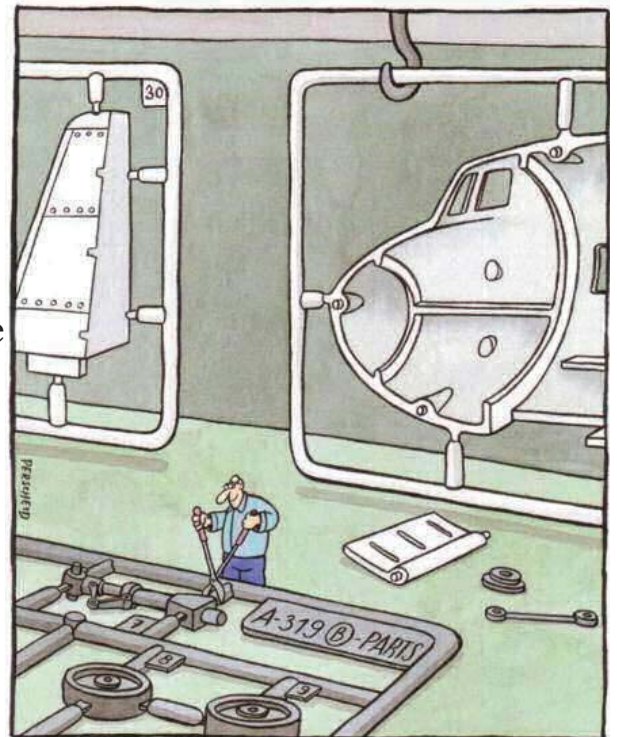

Juergen's job at Airbus was exactly like his childhood dreams.

Cincinnati Show Report

By D. M. Knights

On October 12th, the Cincinnati IPMS club hosted their annual invitational contest. I have to admit that this is one of my favorite shows. The venue is well lit and spacious. The crowd it attracts seems to be very friendly and it is a time where I get to see many old friends. As I have done, I attended as a vendor this year, sharing my table with Scott “Skippy” King and our very own Cranky Canadian Columnist, Jim Bates. Jim commented that this show has some of the best vendors for its size of any show around, and I have to agree. CRM was not there this year. Given gas prices, I think that Chris has deemed the show too far to travel. However, a number of other big vendors were in attendance, including John Voitec of UMM-USA as well as Mid-Tenn Hobbies, Starfighter Decals and Fündekals among others.

Attendance this year was down slightly as was the number of entries. Part of that was due to the fact that our own club, MMCL, had fewer members attending and entering. I am sure that Rich Guetig’s absence was keenly felt in the total number of entries. I have noticed that this year that shows in our Region have seen a slight decrease in the number of models entered and the number of modelers entering. I think that this may indicate that the rising gas prices and slowing an economy may be having an effect on the people involved in our hobby. Jim Bates tells me that shows out on the west coast are seeing increases in the number of entries and entrants. Maybe that part of the country is seeing a better economy. I don’t know the answer.

The models entered were great. Following you will find some photos by Jim and me. I hope you enjoy them.







The Cranky Canuck

By Jim Bates

Jim's Cincinnati show notes--On October 12, 2013, I had the pleasure of attending the Cincinnati Scale Modelers Contest and Swap Meet, held once again at the Scarlet Oaks Vocational School and Girls' Reformatory - oops, sorry, that last part may have been fantasy. Total entries were down a little from previous years. There were 260 models on the tables and, as always, the quality was good, though 1/48 outpaced 1/72 this year.



The vendor area was excellent. I held off on the new Starfighter decals F9F Panther sheet, but did succumb to the new Airfix Harrier GR.1. Somehow I was able to withstand all of the John Vojtech's Czech kits. I spent more time at Cincinnati selling kits and chatting rather than taking photos and happily sold almost everything I brought. Money seemed to be changing hands at a brisk pace in the vendor area.

I always have big fun at this show - good vendors, good models, and lots of conversation with friends both old and new.

The Sea King in 1/72 Scale

First purchased for the Royal Canadian Navy in 1962 as the CHSS-2 and delivered between 1963 and 1969, it is almost unbelievable that the Sea King is still serving with the Royal Canadian Air Force in 2013. When the first Sea King was delivered in 1963, I'm sure no one imagined that 50 years later the Sea Kings would become the longest serving helicopter in Canadian military history. These forty-one aircraft, four built by Sikorsky in the United States and 37 assembled in Canada by United Aircraft of Montreal have given yeomen's service to the Royal Canadian Navy, the Canadian Armed Forces, and the Royal Canadian Air Force and the Sea King certainly deserves a place on the shelf of any Canadian modeler.

There have been four 1/72 Sea King models issued in 1/72:

Airfix Sea King

First off the bat was the Airfix Sea King. Issued in 1969, it has been in production almost continually since that year. One of Airfix's biggest sellers, it was upgraded along the way into a Westland Sea King as used by the Royal Air Force and Fleet Air Arm and is currently in the catalogue as a Westland Sea King HAR.3/Mk.43 and HAR.5. My version of the kit is a rare Canadian boxing as a CH-124A Sea King by Carmichael Airliner Models Ltd of Leduc, Alberta. I'm not sure of the date of this release, but I remember seeing it on the shelves in the 1980s. Molded in white, this boxing of the Airfix mold is the early SH-3 is-

sue before any of the changes were made to better reflect a Westland-built Sea King. It is, of course, a kit of its time with sparse detail, no cabin interior, thick clear parts, and with the outer surfaces covered in raised rivets and panel lines. My kit is reasonably well molded, but unfortunately, I have heard that over time the molds have suffered and the kits in production today have many issues with fit and finish. The only interior detail is in the cockpit, but you do get the option of building the kit to raise and lower the dipping sonar by turning the rotors, and there is a SAR basket and a figure to fit upon it. Even though decals are provided for a CH-124A, the type cannot be made from the kit, as it represents an early SH-3 and lacks the engine FOD guard and rear fuselage radome. The decals are reasonably well done, but oddly the instructions suggest to paint the helicopter white, rather than the correct 501-109 blue-grey. Much like the Sea King in RCAF service, this kit is in need of replacement by Airfix.

Fujimi Sea King

The second Sea King out of the gate was the Fujimi kit, which shows an amazing leap in molding and detail. I believe this kit was issued in the 1980s and is very cleanly molded in grey plastic with beautifully molded clear parts. While the kit was based upon the Sikorsky Sea King, it does include many alternate parts to build a Westland version. (My example is a Westland boxing.) Included are two sets of tail rotors, two tailplanes, and two sets of landing gear spon-

sons. Everything needed to build a Canadian Sea King is included in my boxing; though, as always, many small details, especially antennas, will need to be added by the modeler. Cabin detail is included for both a troop transport Sea King and a dipping sonar equipped ASW example. Exterior detail is also encrusted with raised rivets and panel lines, but it is very finely done, and almost in scale. The Fujimi kit does include four torpedoes as under fuselage stores, but I am unsure if they are appropriate types for a Canadian Sea King. Even though this is an older kit, it is very well done, and quite worth building.

Revell Westland Sea King HAS.6/AEW

Issued in the 1990s after Revell had previously reboxed the Fujimi kit, this Sea King is based upon the Westland Sea King as built in Europe. That means that many details are different from the Canadian and US build examples. The most obvious of these are different rotor blades, extra windows in the fuselage, and large bulge over the transmission housing on the fuselage. That being said, this kit is beautifully molded and probably the most detailed Sea King in 1/72 scale. The exterior is covered with even more finely raised rivets than those included in the Fujimi and finely recessed panel lines. Options include wheel sponsons, interior details, tail rotors, dust filter or FOD guards, and radomes, antennas, and ECM fittings. My boxing also includes parts to build the Fleet Air Arm AEW Sea King with the inflatable radome attached to the

door. This is a beautiful kit, but it would take quite a bit of work to convert it back into a Sikorsky built Sea King.

Cyber-Hobby SH-3D Sea King



The most recent Sea King is the rather expensive Cyber-Hobby kit that has been issued in many versions, the most appropriate for a Canadian Sea King being the SH-3D. Housed in a large box, it is beautifully molded in grey plastic, with some excellent slide mold technology on display. (The engine intakes are an amazing piece of molding.) The exterior surfaces have beautifully petite recessed panel lines and rivets, but the interior is a mixture of good and bad. The cockpit is well outfitted - the pilot seats even have seat belts - but is missing collectives. The cabin has some nice detail, but the cabin seats are comically small. (There are 20 little seats in the cabin, which appear to be sized for hobbits.) The rotor blades are molded with droop in place, a nice door machine gun is included, and the kit does include cabin steps which will be useful to model one of the Standing Contingency Task Force troop transport CH-124Bs. Oddly, the fuselage is done in five pieces, with the lower hull

being separate. It is the only kit that will allow the forward cabin door to be posed open without cutting, but the door rails for the large cabin door are huge troughs. You will want to pose the cabin open on this kit to cover them. The clear parts are beautiful, thin and clear.

Sadly, the Cyber-Hobby kit is not the definitive Sea King in 1/72. When you factor in the price, it probably isn't even the best Sea King on the market. That honor goes to the Revell Westland Sea King. I plan to build mine as one of the SCTF troop transport Sea Kings.



An obviously posed photo of an early Royal Canadian Navy CHSS-1 Sea King with some of the different crew members necessary to support operations.

Sea King Decals and Resin

While Flight Colors and Model Alliance (the "special" Hornet scheme oddly captioned as CH-126) have issued CAF Sea King decals and Cutting Edge has issued RCN decals in the past, the only current aviation sheet is by Belcher Bits. Sheet BD3 Canadian Helicopters includes an ear-

ly RCN aircraft in the two tone grey scheme, a mid period CAF CH-124A in the 501-109 blue-grey and a Gulf War aircraft in low-viz grey with female nose art. As with all Belcher Bits products the decals are well done and can be highly recommended.

Belcher Bits has also done a nice resin conversion in 1/72 for the Fujimi Sea King to cater to the Gulf War upgrades made to the Sea King in the early 90s. Resin set BL-01 includes resin parts for the crash position indicator, the FLIR turret, and other ECM updates, as well as some aluminum tubing to cut down to provide for the Sonoboy chutes. This is pretty much a mandatory purchase to model any Canadian Sea King since the early 90s. Belcher Bits can be found at www.BelcherBits.com.



One of the Standing Contingency Task Force troop transport CH-124Bs disgorging troops in the snow.

A WORD FROM OUR GLORIOUS LEADER REGARDING CURRENT YEAR ALUMINUM PRODUCTION

This year's aluminum production has not met the goals of our current five-year plan. Clearly this is not the fault of the Central Committee leadership whose plans are, as always, faultless. A review by the Central Committee reveals that the glorious MMCL workers are not at fault either.

Rather, careful investigation reveals that the shortfall is the fault of capitalist running-dogs and their petty bourgeoisie accomplices. Two years ago, aluminum was selling for 75 cents a pound. Today, the current price is 55 cents a pound. This has resulted in a shortfall in aluminum production profits for the glorious motherland.

The Central Committee is confident that the workers will redouble their efforts to make the current production targets. Long live the glorious plastic revolution!!!!

The Gregor FDB-1



by Elwin Ransom

Canada's 'too little, too late' fighter

In 1938, American/Russian expatriate designer Michael Gregor approached *Canadian Car & Foundry*, at the time, the country's leading producer of railroad cars. *Can-Car* had some limited experience building aircraft, but it was only as a sub-contractor, producing machines for Grumman, Curtiss, de Havilland, Consolidated, Bristol and Hawker under license.

In 1938, there were still many proponents of the biplane fighter concept. Most of the major powers used biplanes operationally. The Soviet Union, despite having recently developed the Polikarpov I-16 (the first successful production monoplane fighter with retracting undercarriage), still depended heavily on biplanes. Britain and Germany had developed monoplanes but continued to use the Gloster Gladiator and the Heinkel He 51 biplane fighters. Italy had the Fiat CR.32 and Fiat CR.42 biplane fighters, while the U.S. Navy operated nothing but biplanes.

Similar in size to Grumman's F2F naval fighter, Gregor's FDB-1 had an empty weight of 2,880 lb and a gross of 4,100 lb. Hydraulically operated landing gear retracted flush into large wells on either side of fuselage, ahead of the lower wing. The top wing featured nearly full span slats, and both top and bottom wing had split flaps.

The center section of the top wing on Gregor's fighter had a gull-wing configuration. This was sup-

posed to afford improved visibility. Indeed, the view ahead while flying straight and level was excellent, but marginal when landing and extremely poor when looking downward during approach and landing.



A more successful contemporary – the Grumman F2F. (I know you're going to ask... the orange-yellow on the wings is a standard finish colour, while the lemon yellow on the tails is a unit ID colour.)

The aircraft was designed to carry a pair of 50 cal. guns mounted in the fuselage, but armament was never installed. Additionally, two bombs were to have been carried, one under each lower wing (*FDB = Fighter Dive Bomber*).

Designed, built and tested in less than eight months, the FDB-1 was sent to Saint-Hubert Air Base, near Montreal, for preliminary service testing with the RCAF. After extensive trials, pilots complained of severe canopy vibration at speed and during strenuous manoeuvres, and it was recommended that all testing be restricted until this was remedied. Unfortunately for Gregor and *Can-Car*, further testing showed that their performance projections had been highly optimistic.

Even with an upgraded engine, the FDB-1 probably would have performed no better than the Fiat C.R. 42, which made its maiden flight early in 1939 and was operated by Italy, Belgium, Hungary and Sweden.

In a last-ditch effort to generate some interest in its new fighter, *Can-Car* entered the FDB-1 in the January 1940 New York-to-Miami air race. Shortly after takeoff, a loss of oil pressure forced the FDB-1 to land in New Jersey, thereby disqualifying it. Two months later, during testing, its landing gear collapsed at Saint-Hubert. Although Mexican officials had expressed interest in the aircraft, the Canadian government refused an export license. There were no other prospective customers for a biplane fighter in what was now an age of monoplanes.

A bitter Gregor was quoted as saying: "*They'll start this war with monoplanes, but they'll finish it with biplanes.*" He was wrong. Neither his prediction nor his aircraft were to survive the test of time. After several years of sitting idle in storage, the FDB-1 was destroyed in a hangar fire at Montreal's Cartierville Airport, and Michael Gregor soon followed it into obscurity.

Two in a series of photos taken at the same time (note the parachute sitting on the wing), reportedly at Roosevelt Field, Long Island.

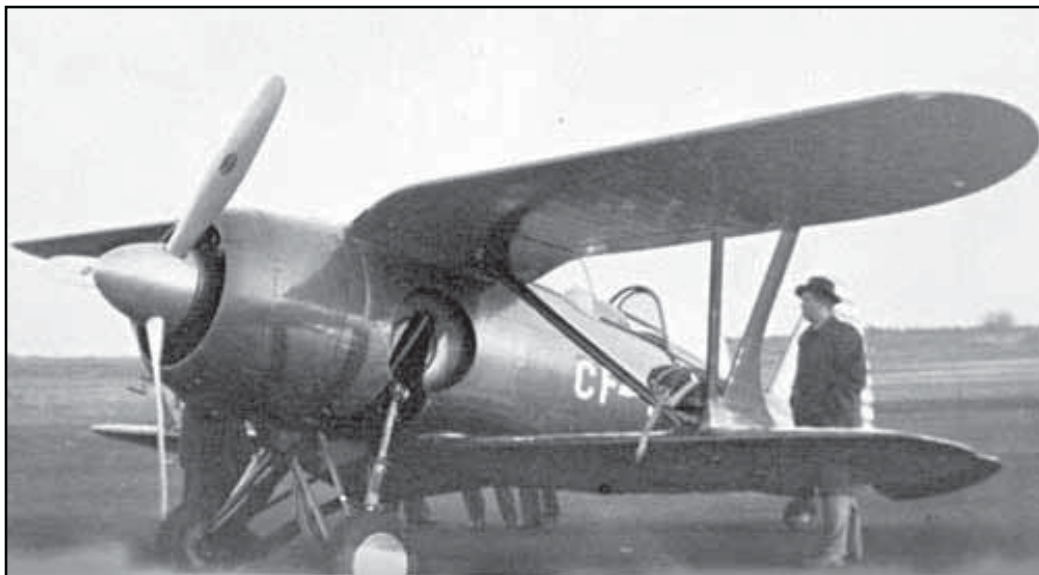

This 3/4 rear shot provides a good view of how the gull wing meets the fuselage. You can see why visibility was a big concern.

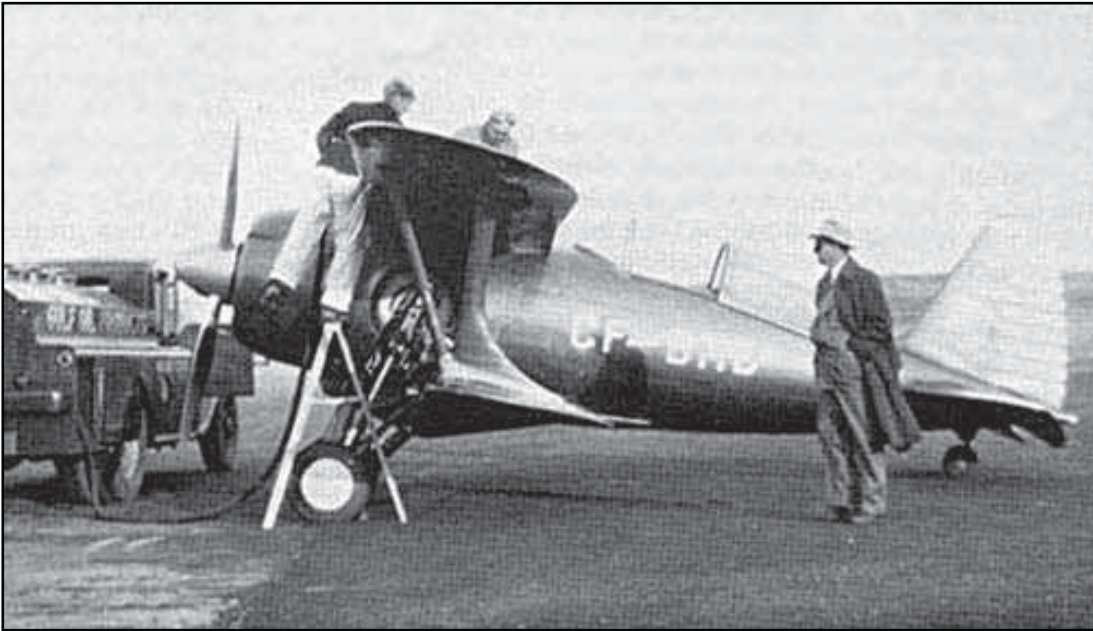

The FDB-1 is topped up from a fuel truck prior to flight.

Pilot is in the cockpit preparing for flight. Were it not for the upper wing, the large canopy would have provided an excellent view all around.

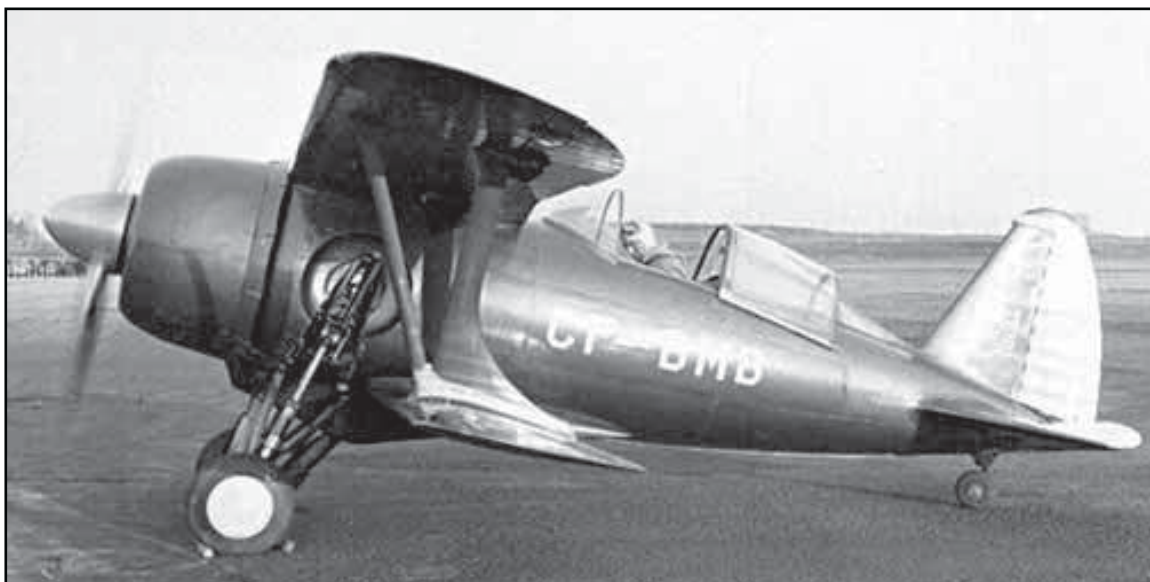
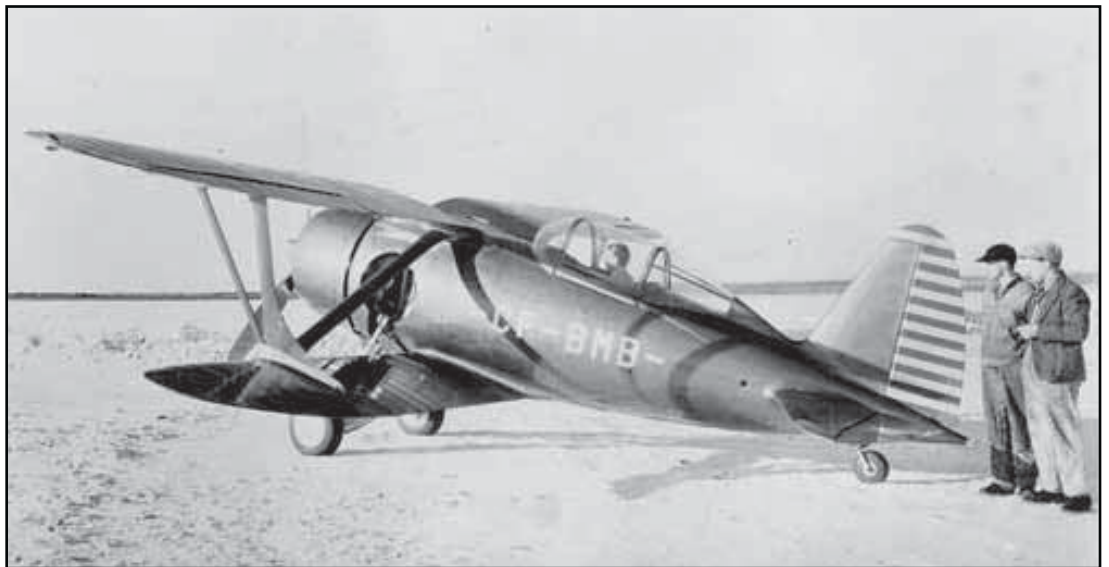

Getting ready for take off. The engine is revving but the wheels are still chocked.

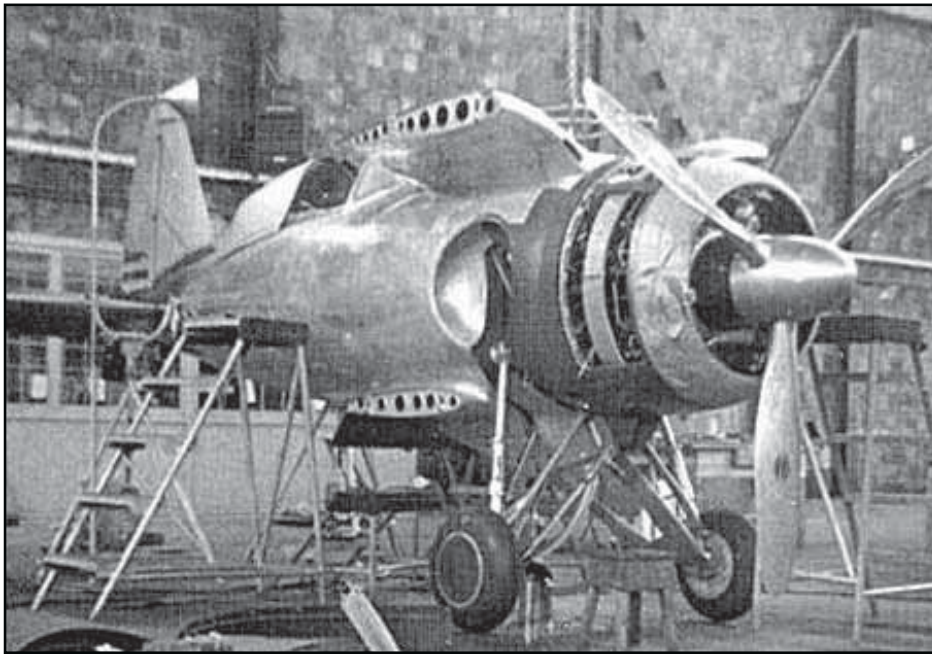

This factory photo shows some of the distinctive features to good advantage. Note how the upper gull wing attaches to the fuselage. And you can also see the undercarriage mechanism and the large wells on the fuselage sides that the wheels retracted into.

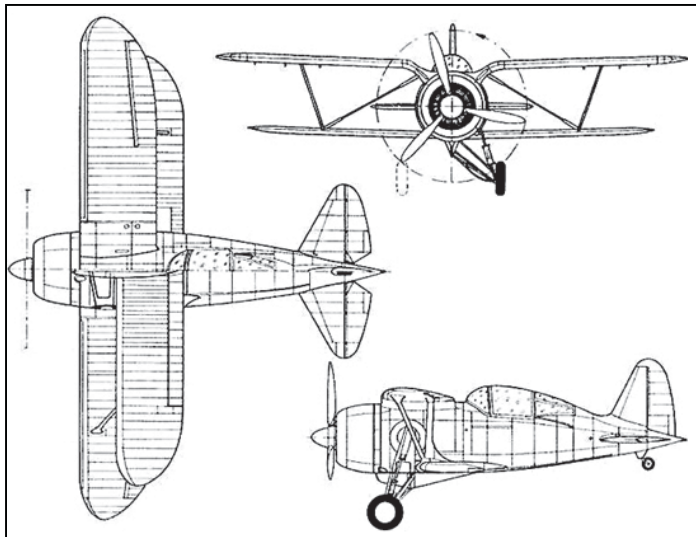

Canadian Car and Foundry Gregor FDB-1.



Can-Vac produced this 1/72 scale vacuformed kit of the Gregor FDB-1 many years ago.

This colour image is from a set of contemporary collectors' cards, and show the colour to be an overall blue with red and white striped rudder. The aircraft colour has actually been described as a metallic greyish blue. Was it possibly a standard Can-Car colour?

This article is reprinted with kind permission from BeaverTales, the electronic newsletter of IDMS/Canada. Tactical Notes editor is grateful for the permission to re-print it here.



Financial Report

By ALEX RESTREPO

Oct 2013 PNC Bank

Starting Cash Balance: \$4,346.85

Cash Receipts	Date	
Workshop fees	10/5/2013	\$60.00
Raffle	10/17/2013	\$47.00
Recycling	10/17/2013	\$23.10
Workshop fees	10/26/2013	\$35.00
New Member	10/26/2013	\$10.00
TOTAL RECEIPTS		\$175.10

Cash Or Debit Expenses:	Date	
Check # 7031 (E) KYANNA Rent	10/10/2013	(250.00)
Cash- storage bins for store room	10/17/2023	(36.73)
TOTAL EXPENSES		(\$286.73)

NET Monthly Increase(Decrease): (\$111.63)

ENDING CASH BALANCE: Oct 2013 \$4,235.22

2013 Cincinnati Scale Modelers Contest-another take

By Jim Bates

On October 12, 2013, I had the pleasure of attending the Cincinnati Scale Modelers Contest and Swap Meet, held once again at the Scarlet Oaks Vocational School and Girls' Reformatory - oops, sorry, that last part may have been fantasy. Total entries were down a little from previous years. There were 260 models on the tables and, as always, the quality was good, though 1/48 outpaced 1/72 this year.

The vendor area was excellent. I held off on the new Starfighter decals F9F Panther sheet, but did succumb to the new Airfix Harrier GR.1. Somehow I was able to withstand all of the John Vojtech's Czech kits. I spent more time at Cincinnati selling kits and chatting rather than taking photos and happily sold almost everything I brought. **Continued on bottom of page 19**

President's Page

By Stu Cox

MMCL Members,

Our next MMCL Monthly meeting is Thursday, November 21st at 7:00PM at the Kyana Facility at 3821 Hunsinger Lane.

Please visit our newly updated and evolving club website at **www.mmcl.org**. John Sachs has put in a lot of hard work, and is in need of content information from our club members. He can use new kit reviews, tips & techniques and book reviews. Also, if you have photo's of models from past shows, he would be glad to post these as a historical and visual reference. Thanks to John for all that he has done in support of website development. Also, be sure to visit the **MMCL CLUB and GROUP pages on FACEBOOK!** Lot's of regular posts are placed there, usually on a daily basis!

SMACKDOWN!!!! Okay, we have MOVED the KOKO infused "Dragon Old School" Smackdown to the NOVEMBER meeting. Please Focus on completing your finished "Dragon Imperial or Gunze origin DML Kit" for this armor maven smackdown. **NO SMART KITS! January will be the Ki-44 smackdown.** Feel free to offer up a smackdown idea.

Also, please bring any and all kits or projects that you have in process for show-n-tell! Also, please consider reviewing any new modeling accessories or products that you have discovered for your fellow members in a "live format".

We are approaching year end, and I encourage each of you to evaluate your current **IPMS MEMBERSHIP** status. MMCL has a long history of supporting IPMS and having a good representation of members in our club. All of our club officers are required to be IPMS members, and we have maintained a number of regular memberships within the ranks of our club. I encourage you to go to <http://www.ipmsusa.org/> to learn more about membership and to complete the process. We look forward to a great meeting and will see you all on Thursday, November 21.

Money seemed to be changing hands at a brisk pace in the vendor area.

I always have big fun at this show - good vendors, good models, and lots of conversation with friends both old and new.

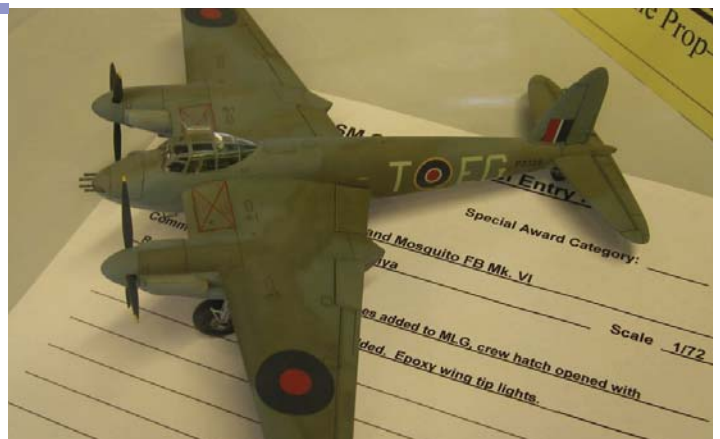

Military Modelers of Louisville Membership Form 2014

Name: _____

Address: _____

City: _____ ST: _____ Zip: _____

Phone: _____ E-mail: _____

Birth Date: _____ Year Joined Club: _____

Would you like to receive your newsletter by e-mail? The e-mail version of Tactical Notes is in full color and is sent using the PDF format: Yes _____ No _____

Do you give MMCL permission to place your contact information on the club website: Yes _____ No _____

What are the advantages of membership to the Military Modelers Club of Louisville?

- Monthly meetings held on the third Thursday of the month at the club workshop located at 3821 Hunsinger Lane in Louisville KY.
- A monthly subscription to the official newsletter of the Military Modelers Club of Louisville, Tactical Notes. Tactical Notes contains kit reviews, editorials and modeling techniques.
- The Club Workshop. MMCL has its own club workshop. This is a great place for modelers to build kits and have a good time. The club provides tables, work lights and various tools. We also have quarterly all night model building sessions at this location.
- Quarterly in house model contests with prizes.
- Monthly model kit raffle.
- Annual club cookout.

All of this and more is included in your yearly \$10.00 membership (junior \$5.00) dues.

Please complete all information above and forward your check made out to MMCL for \$10.00 to:

Stu Cox, President
4100 WIMPOLE ROAD
LOUISVILLE, KY 40218
502-499-6618
COX40218@BELLSOUTH.NET

Please visit us on the web at WWW.MMCL.ORG

PD DT _____