

Indian ARCHERY



CATALOG 200

The Archery of Champions

INDIAN ARCHERY & TOY CORPORATION
EVANSVILLE, INDIANA, U.S.A.

PHONE
LAurelton
7-0728

EASTERN STATES
LEONARD E. ROTHFIELD
130-07 225TH STREET
LAURELTON 13, N.Y.



PHONE
RO 6-5111

MINNEAPOLIS OFFICE
CHUCK STEVENS
6455 LYNDAL AVE. S
MINNEAPOLIS 23, MINN.



PHONE
Douglass 8677

PACIFIC COAST STATES
CURLEY-BATES CO.

575 MISSION STREET
SAN FRANCISCO, CALIF.

Main 7920

112 SPRING ST.
SEATTLE, WASH.

Richmond 7-7629

3001 S. BROADWAY
LOS ANGELES, CALIF.



PHONE
RI 8-5886

SOUTHERN STATES
ARTHUR BLOCH
1000 MAIN STREET
DALLAS, TEXAS



PHONE
Rogers Park
1-1093

CENTRAL AND MIDWEST STATES
MARK NEUMANN
6150 N. ROCKWELL STREET
CHICAGO, ILL.



PHONE
2-2572

SOUTHEASTERN STATES
E. A. KNOTH
COUNTRY CLUB ROAD
AT MONROE STREET
BREVARD, N. C.

LEMONWOOD TARGET, HUNTING, AND TOY BOWS
GLASS TARGET, HUNTING, AND TOY BOWS
PROFESSIONAL ARCHERY TACKLE
JUNIOR ARCHERY SETS
TOY ARCHERY SETS
DARTS AND DART GAMES
BAT-MINTON GAMES - STILTS
LINESMEN CHAINS
GOAL FLAGS - SIDELINE MARKERS

Established More Than 30 Years



There's Added Profit in

INDIAN

Archery Tackle and Equipment

WORLD'S LARGEST SUPPLIERS

INDIAN ARCHERY & TOY CORPORATION

No. 16 TO 24 CLARK STREET

EVANSVILLE, INDIANA, U.S.A.

Phones: HA 5-3170
HA 5-3179

THE NEW IMPROVED GLASSFLEX BOWS

MADE FROM FINEST FIBRE GLASS UNDER TENSION



No. 25G.R.T.—WORLD BEATER—This is it. A 5'2" GLASSFLEX RECURVED TARGET Bow in pulls 20 to 40 lbs. at 28" draw. Calfskin wound leather grip. Plastic Tips. Double arrow rest for right or left handed shooters. Double loop Dacron string. Beautifully finished. Minimum jar. Unaffected by temperature or humidity. Weight each 1 1/2 lbs.

No. 25G.R.H.—Same as above except Hunting type. Pulls 45 to 70 lbs.



No. 29H TARGET BOW—Length 60 inches, 18 to 40 pounds pull. For right or left-handed archers. Narrow handle. Genuine leather grip. Double loop Dacron string. Unaffected by temperature or humidity. No warm up needed in extreme cold. For Plastic Tips. Weight 1 pound.

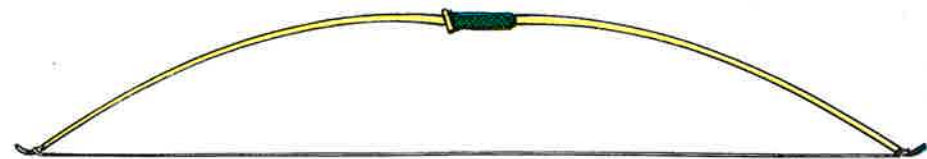

No. 22G GLASSFLEX JR.—Professional shape. Made of molded fibre glass. Plastic Grip. Handmade Italian Hemp string. Plastic Tips. Length 54". Not made in special pulls. Wt. 1 lb.

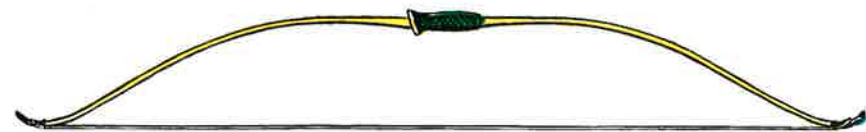

No. 22G.R.—Same as No. 22G except Recurved

GLASSFLEX BOWS



No. 23G.R. GLASSFLEX RECURVE—Here is a real glass recurve bow 48" long. Natural bone finish. Strong hemp string. Plastic Tips. Plastic Grip. Double arrow rest for right or left handed archers. Not made in special pulls. Weight 8 ozs.



No. 24G GLASSFLEX MIDGET—Professional shape. Made of molded fibre glass. Handmade Italian Hemp String. Molded plastic handle. Plastic Nocks. Natural color. Length 42". Not made in special pulls. Weight 7 ounces.



No. 24G.R.—Same as above except Recurved

COMPOSITE TARGET AND HUNTING BOWS



No. 261 TARGET MASTER—Here is the finest of target bows with built-in reflex. Double Loop Dacron String. Wound calf skin grip. Beautifully finished. Guaranteed for 1 year. Length 5'6". Pulls 25 to 50 lbs. The facing is Lamacoid. The core is built of maple strips. The backing is a layer of fibre glass.

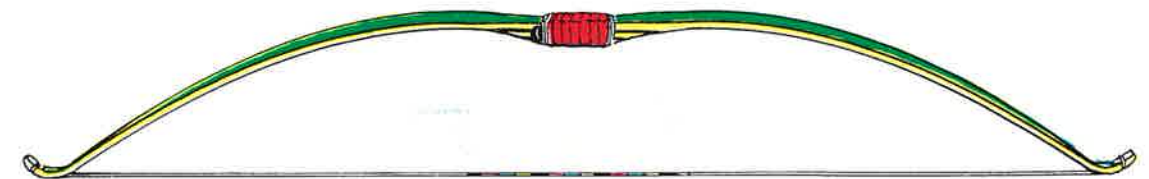

No. 262 THE GAMESTER—THE FINEST BOW FOR THE HUNTER EVER BUILT. A fully REFLEXED and RECURVED BOW with sufficient width to insure maximum speed and durability. This bow has a Lamacoid facing. The core for resiliency is built of maple strips. It is backed with a layer of glass fibre. Beautifully finished. Double Loop Dacron String. Wound calf skin grip. Guaranteed for 1 year. Length 5'2". Pulls 45 to 70 lbs.

FIBRE GLASS HUNTING & TARGET SETS

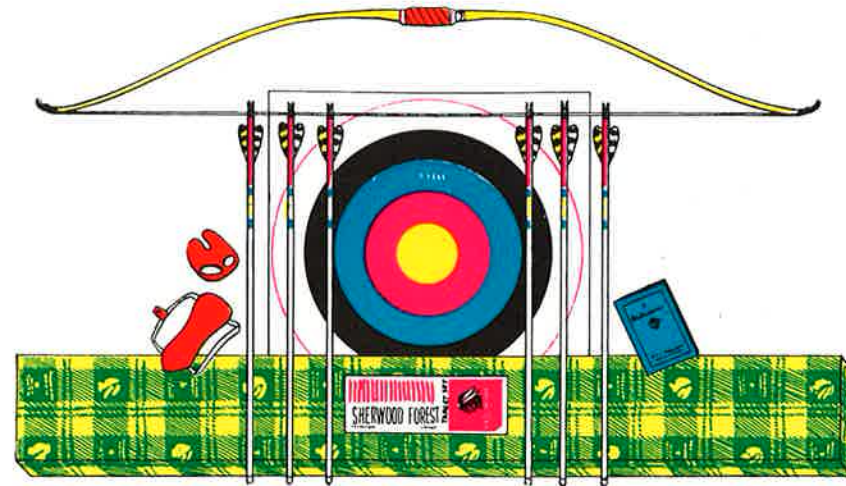

No. 259 SHERWOOD FOREST TARGET SET with 5'2" WORLD BEATER No. 25GR bow. For right or left handed archers. Balance of set consists of 6 Port Orford Cedar arrows. One armguard. One Tab. One 2' target face. One handbook. Beautifully boxed. Pulls 25 to 45 lbs. at 28" draw. Weight each 3 lbs.

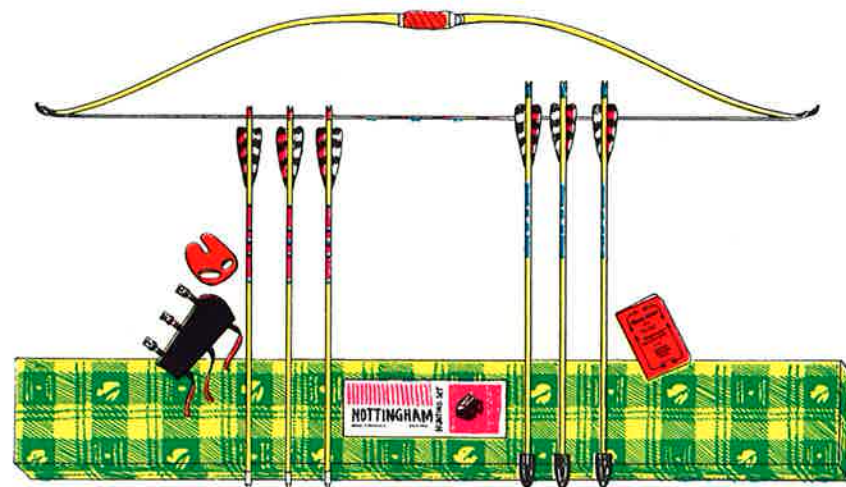

No. 260 NOTTINGHAM HUNTING SET with 5'2" WORLD BEATER No. 25GR bow. For right or left handed archers. Balance of set consists of 3 non-skid and 3 Hi-Precision broadhead hunting arrows. These are our fine arrows, matched and spine tested. One cowhide armguard. One tab. One handbook. All beautifully boxed. Pulls 45 to 70 lbs. at 28" draw. Weight each 3 1/4 lbs.

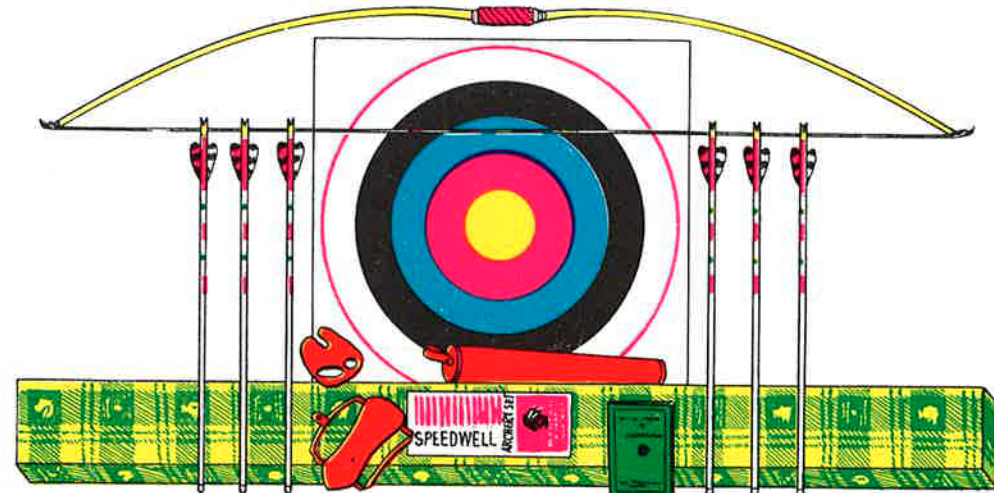

No. 403 SPEEDWELL GLASSFLEX BOW—5' long with soft genuine leather wrapped grip and handmade Dacron bow string. Finished natural color. Balance of set consists of: Six beautifully finished arrows and feathered with three ground feathers. One target face, one armguard, one formed quiver, one tab, one handbook. Beautifully boxed. Weight each 2 3/4 lb. Pulls 20 to 40 lbs.

TARGET SETS FIBRE GLASS

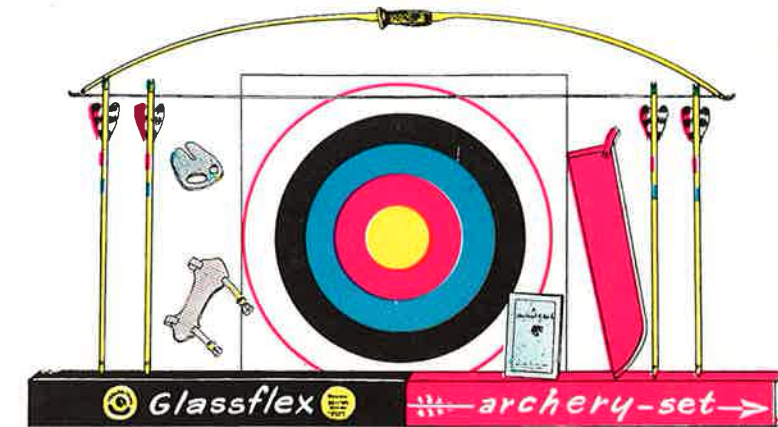

No. 400G—PREMIER GLASSFLEX BOW—4 1/2' long with plastic handle and handmade Italian hemp bow string. Four arrows beautifully finished and three ground feathers. Balance of set consists of target face, armguard, tab, quiver and handbook. Beautifully boxed. Weight each 2 lbs.

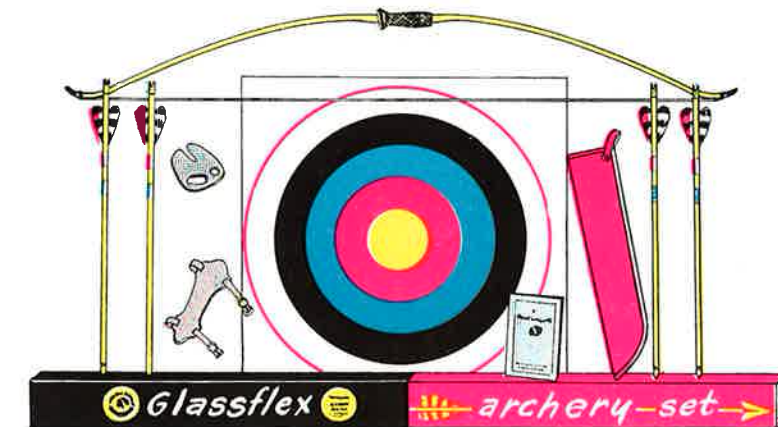

No. 400G.R.—Same as above except box is Recurved.

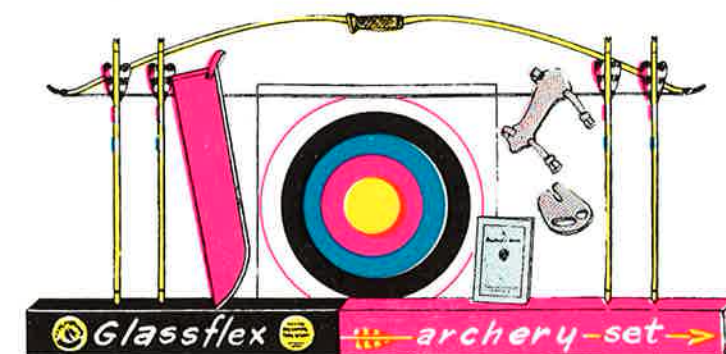

No. 401G.R. CHEROKEE Recurve Glass Bow 4' long. Natural bone finish. Four arrows beautifully finished and fletched, 16" target face, armguard, scabbard quiver, finger tab and instruction book. Beautifully boxed. Weight 1 pound, 6 ounces.

TARGET SETS FIBRE GLASS



No. 402G FUNSTER GLASSFLEX BOW—3½' long with plastic molded handle. Plastic nocks. Handmade Italian hemp bow string. Three arrows beautifully finished and with three ground feathers. Balance of set consists of target face, quiver and handbook. Beautifully boxed. Weight each 1 lb.



No. 402G.R.—Same as above except bow is **Recurved**.

NOTICE

Warn your customers—bows should always be unstrung when not in use. Never leave glass bows in the trunk or back seat of a car on a hot day. The excessive heat may damage them.

LEMONWOOD BOWS—FLAT TYPE



No. 20 FALCON—HAND TILLERED FLAT lemonwood bow with reinforced fibre ends. Natural finish. Built up narrow handle and LAMINATED with colored contrasting material. Handmade Dacron string. Wound leather grip. Bow sight. Arrow rest. Elastic string keeper. Beautifully finished. Made in 5' 6" and 5' 9" lengths. Pulls 20 to 45 lbs. Wt. 1 lb. 2 oz.

No. 21 FALCON—HAND TILLERED FLAT lemonwood bow. Fibre ends. Natural finish. Handmade Dacron string. Soft leather grip. Bow sight and arrow rest. Elastic string keeper. Built up narrow handle LAMINATED with colored contrasting material. Length 5' 2". Pulls 18 to 30 lbs. Wt. 14 oz.

No. 22 FALCON—HAND TILLERED FLAT lemonwood bow. Plain ends. Beautifully finished. Hemp string. Soft leather grip. Built up narrow handle. Elastic string keeper. Length 4½'. Wt. 9 ounces.

No. 23 FALCON—HAND TILLERED FLAT lemonwood bow. Plain ends. Beautifully finished. Hemp string. Soft leather grip. Built up narrow handle. Elastic string keeper. Length 4'. Wt. 8 ounces.

No. 24 FALCON—Same as No. 23 except Bow is 3½ feet long. Wt. 5 ounces.

LEMONWOOD BOWS BACKED—FLAT TYPE



No. 19E HAWK BOW—Comes backed with Fibre. Hand tillered, flat-type lemonwood bow with inlay of colored contrasting material in the handle and with ends reinforced with fibre. Natural Color, with beautiful buffed wax finish. Wound leather grip. Bow sight, arrow rest, handmade Dacron string, elastic string keeper. Length 5' 2". Pulls 18 to 30 lbs. Wt. 1 lb. 2 ozs.

No. 19A HAWK BOW—Particularly designed for School and Camp use. Comes backed with Fibre. Hand tillered, flat-type Lemonwood Bow, with inlay of colored contrasting material in the handle and with ends reinforced with colored fibre. Natural Color, with beautiful buffed wax finish. Wound leather grip. Bow

sight. Arrow rest. Handmade Dacron Bow String, with served center. Elastic string keeper. Made in 5' 6" and 5' 9" lengths. Pulls 20 to 50 lbs. Wt. 1 lb. 6 ozs.

No. 19 FLEETWOOD BOW—Comes backed with Rawhide. An extremely powerful bow. Made of the finest quality Lemonwood that has been scientifically seasoned. It has an inlay of colored contrasting material in the handle and a reinforcement of fibre on the ends. White fibre arrow plate. Comes in a Natural Color, with a beautiful finish. Wound leather grip. Bow sight. Arrow rest. Handmade Dacron Bow String, with served center. Elastic string keeper. Made in 5' 8" and 5' 9" lengths. Pulls 30 to 50 lbs. Wt. 1 lb., 9 ozs.

SPliced LEMONWOOD BOWS—FLAT TYPE

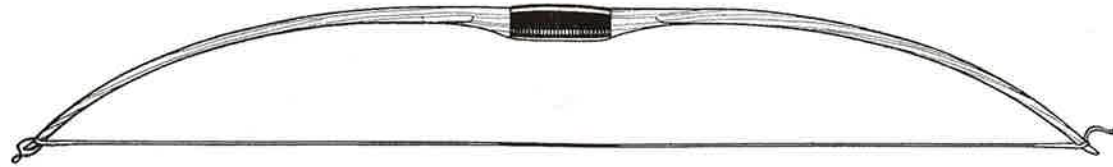

No. 20S—Flat Lemonwood Target Bow. Center Spliced with Fish-tail Joint. Reinforced fibre ends. Narrow handle. Strong Hemp String. Soft Leather Grip. Elastic string keeper. Length 5' 6"; pulls 20 to 45 pounds. Wt. 1 lb. 2 ozs.

No. 21S—Same as above except 5' long and pulls 20 to 30 pounds. Wt. 14 ozs.

No. 20S-F.B.—Same as No. 20S except Fibre backed and Dacron string. Wt. 1 lb., 4 ozs.

No. 21S-F.B.—Same as No. 21S except Fibre backed and Dacron string. Wt. 1 lb., 1 oz.

LEMONWOOD HUNTING EQUIPMENT

The consensus of opinion of those hunters who want an all around hunting bow for most uses in this country is that the bow should have the following qualifications:

- 1—Bow should be short in order not to catch in thick underbrush.
 - 2—Bow should be fairly light in weight (perhaps from 50-60 pounds) in order that maximum accuracy may be maintained.
 - 3—Bow should be hardy enough to stand vigorous weather and not be fractured from average abuse.
 - 4—Bow should have arrow guide to protect left hand against splinters which sometimes develop in arrows that have been driven into hard objects either in roving or hunting. This also aids in quick, fast shooting.
- To fulfill all the above specifications and also it goes without saying that most important, quality of cast to be considered, we recommend a bow that we have built with all the above in mind. These are shown below.

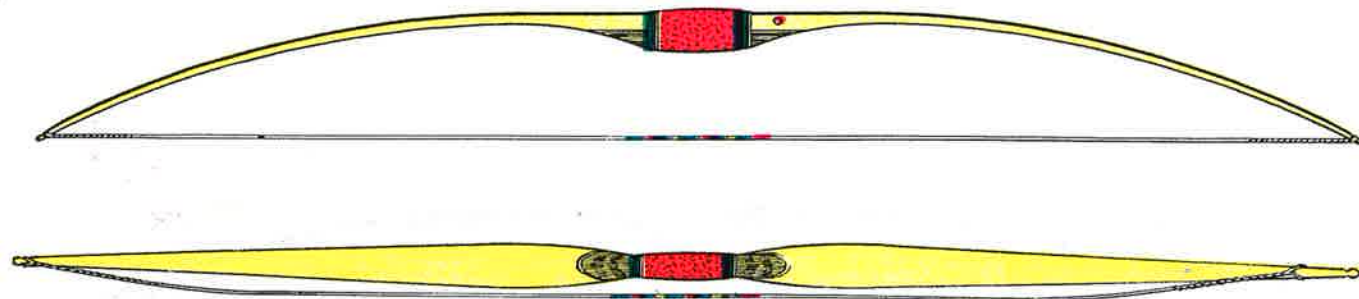

FACTORY No. 358 BACKED LEMONWOOD HUNTING BOW—This bow is designed for hard hitting and distance shooting. Backed with double black and white fibre. Leather Grip. Pulls to 65 lbs. Width at widest place 2". Length over-all 5' 3". Distance, nock to nock 5' 2". Double loop "Ludlow Quality" bow string. With

6" serving. Guaranteed to stand up and give service. Wt. 1 lb., 8 ounces.

FACTORY No. 380 BACKED LEMONWOOD HUNTING BOW—Same as above, except backed with rawhide. Wt. 1 lb., 5 ozs.

SPliced LEMONWOOD HUNTING BOWS

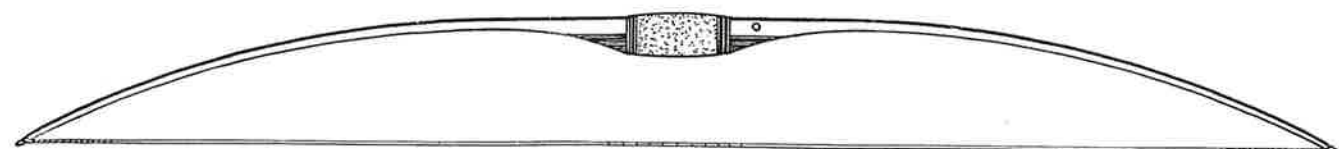

No. 358-SFB—A good hard-hitting Lemonwood Hunting Bow. Single Fibre Back. Width at widest place 1 3/4". Leather Grip. Pull limit,

50 pounds. 5' 3" long. Strong Hemp String. Hand Tillered. Wt. 1 lb., 6 ozs.

PROFESSIONAL ARCHERY SETS

IN THREE STYLES . . .

FITTED IN SUBSTANTIAL WOODEN BOXES

HERE IS ANOTHER "INDIAN" TRIUMPH

Archery sets in substantial Wooden Carrying Cases. A joy to merchants, a delight to the customer, these outfits are kept fresh and new and free from dirt and moisture which are always harmful to Archery Tackle. Easy to pack for express or local delivery, ideal for camp purposes.

All bows in sets below have plastic calibrated bow sights and arrow rests.



No. 61 SIOUX—5' flat type Lemonwood bow backed with fibre. Built up narrow handle laminated with colored contrasting material. Handmade Excel String. Seven footed arrows with plastic nocks and ground feathers, fine quality leather arm guard, one

genuine leather shooting glove with molded tips, one 19" combination leatherette and leather quiver, on 24" paper target face, instruction book. All packed in a very substantial wooden carrying case, which is nicely finished. Weight each 6 1/2 lbs.

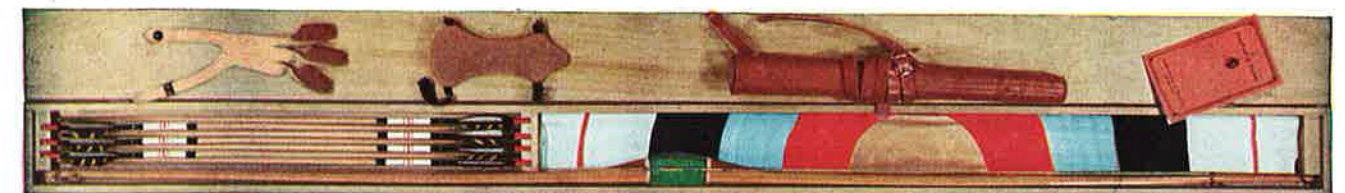

No. 63 UNIVERSITY—5' 8" Flat type Lemonwood bow with fibre backing and built up handle laminated with colored contrasting material, handmade Excel string, seven 26" footed arrows with plastic nocks and ground feathers, fine quality leather shooting

glove with molded tips, one good grade genuine leather arm guard, one genuine top grain leather quiver, one 36" paper target face, handbook. Packed in wooden carrying case, which is nicely finished. Weight each 9 lbs. 6 ozs.

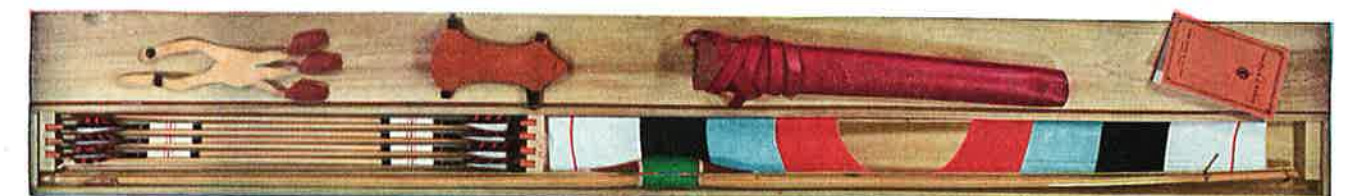

No. 66 MIAMI—5' 8" Lemonwood bow backed with rawhide with handle built up and laminated with colored contrasting material, handmade Excel string, seven 26" footed arrows with plastic nocks and ground feathers, one genuine leather arm guard, one

leather shooting glove with molded tips, one 36" paper target face, leather quiver, beautifully embossed and with belt, instruction book. Packed in wooden carrying case, nicely finished. Weight each 9 lbs. 6 ozs.

MEDIUM GRADE ARCHERY SETS

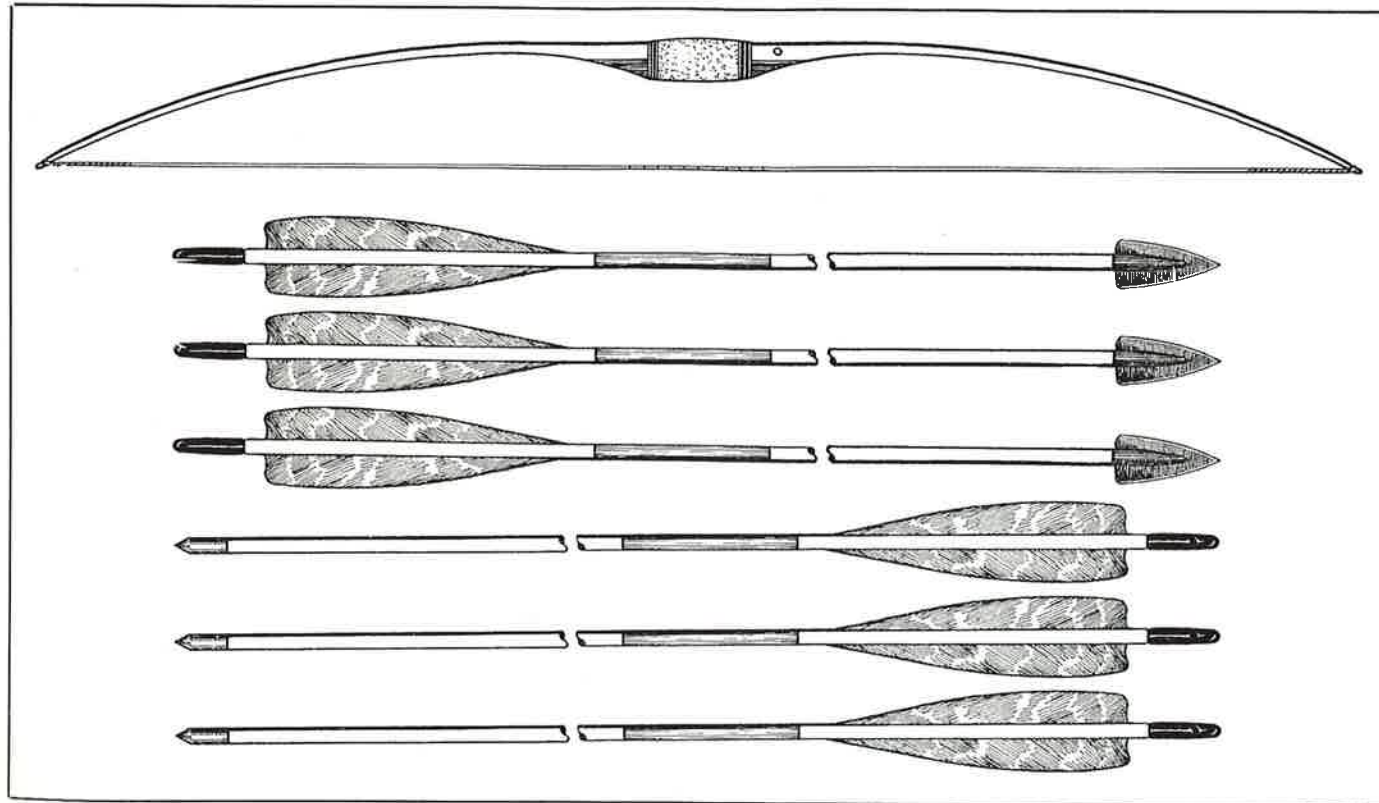

No. 67 WOODSMAN HUNTING SET—5' 3" single fibre back Lemonwood Hunting bow with strong Hemp String. Same bow as our No. 358-SFB Six Arrows. (Three our No. 356 Broadheads and three our No. 359½ Non-skid field points.) Pulls 35 to 50 pounds. Packed in brown corrugated box with attractive label. Wt. 3 lbs.



No. 69 ACADEMY SET—5' 8" Spliced Lemonwood Bow. Strong Hemp Bow String, leather grip, six 26" Port Orford Cedar Arrows with plastic nocks; one 36" paper target face, shooting tab, and

a new spearhead-type padded leather arm guard, instruction book, scabbard quiver. Boxed in brown corrugated box with attractive labels. Wt. 3¼ lbs.



No. 68 ACADEMY SET—5' Spliced Lemonwood Bow (with strong Hemp Bow String), six 24" Port Orford Cedar Arrows with plastic nocks, one 24" paper target face, shooting tab, and a new

spearhead-type padded leather arm guard, instruction book, scabbard quiver. Boxed in brown corrugated box with attractive labels. Wt. 2¾ lbs.

CUSTOM HUNTING ARROWS

Custom—These hunting and field arrows are of the finest 11/32" Select Port Orford Cedar dowels, closely matched in weight and spine. Shaft is dipped the full length in white abrasive resistant lacquer and striped with beautiful multi-colored cresting. Spiral fletched with plain dyed (not barred) precision ground feathers. Spined for bows from 40 to 65 pounds, in standard 26", 27" and 28" lengths.

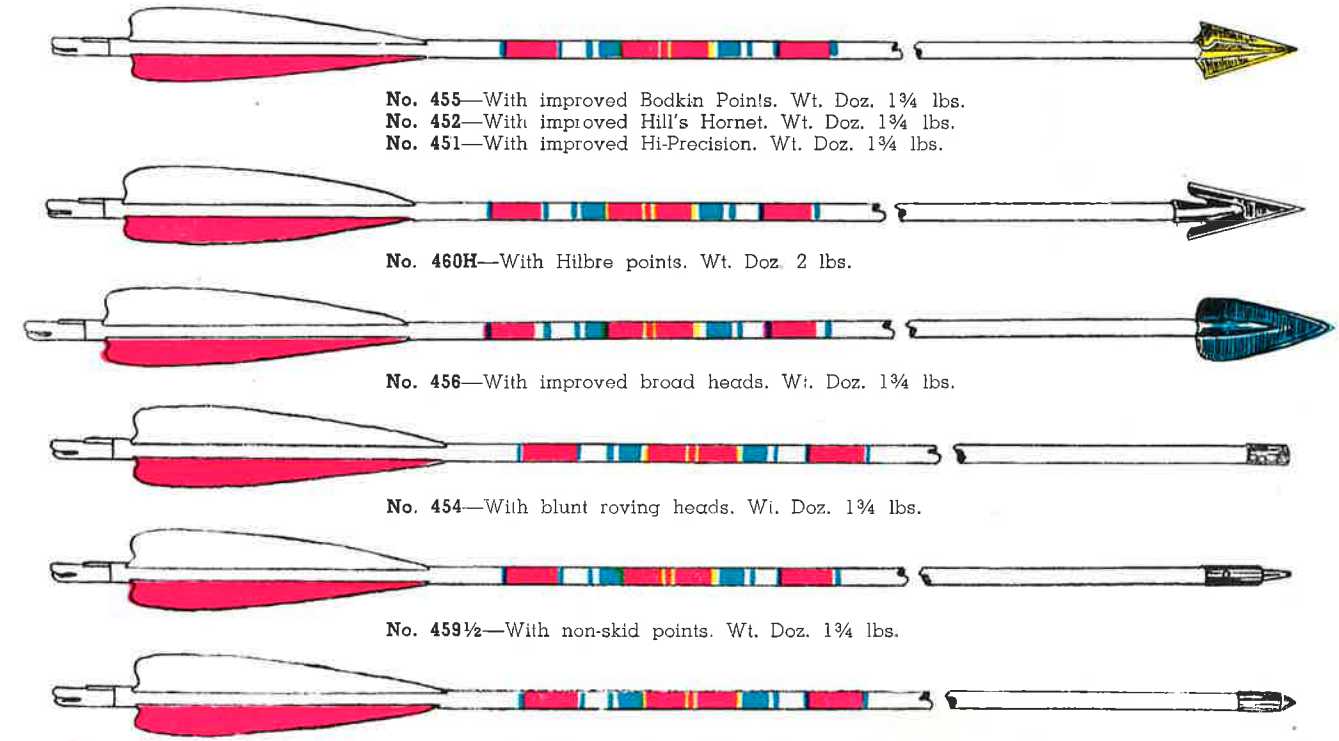

No. 455—With improved Bodkin Points. Wt. Doz. 1¾ lbs.
No. 452—With improved Hill's Hornet. Wt. Doz. 1¾ lbs.
No. 451—With improved Hi-Precision. Wt. Doz. 1¾ lbs.

No. 460H—With Hilbre points. Wt. Doz. 2 lbs.

No. 456—With improved broad heads. Wt. Doz. 1¾ lbs.

No. 454—With blunt roving heads. Wt. Doz. 1¾ lbs.

No. 459½—With non-skid points. Wt. Doz. 1¾ lbs.

No. 459—With field parallel points. Wt. Doz. 1¾ lbs.

STANDARD HUNTING ARROWS

These arrows are made of the finest selection, thoroughly seasoned, Port Orford Cedar. Closely matched for spine. Plastic nocks. Feathers, 5" in length. Nicely finished and crested. Lengths 26", 27" and 28".

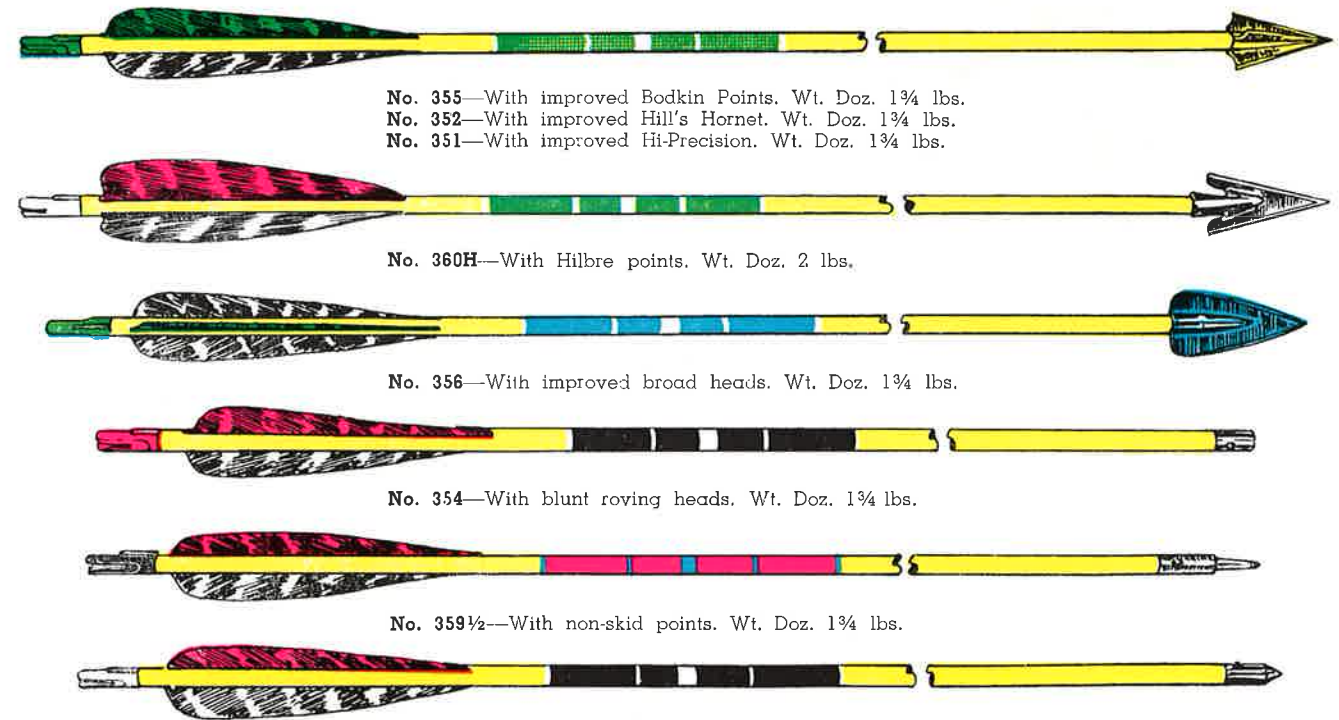

No. 355—With improved Bodkin Points. Wt. Doz. 1¾ lbs.
No. 352—With improved Hill's Hornet. Wt. Doz. 1¾ lbs.
No. 351—With improved Hi-Precision. Wt. Doz. 1¾ lbs.

No. 360H—With Hilbre points. Wt. Doz. 2 lbs.

No. 356—With improved broad heads. Wt. Doz. 1¾ lbs.

No. 354—With blunt roving heads. Wt. Doz. 1¾ lbs.

No. 359½—With non-skid points. Wt. Doz. 1¾ lbs.

No. 359—With field parallel points. Wt. Doz. 1¾ lbs.

NOVICE HUNTING ARROWS



No. 356P—A good practice Hunting Arrow. Made of 11/32" Port Orford Cedar Shafts. Tapered Plastic Nocks. Broadhead Point. Plain grey feathers. Three color crest. 26", 27" and 28". Wt. Doz. 1 1/4 lbs.

No. 359 1/2 P—Same as above except Non-Skid Field Point. Wt. Doz. 1 1/4 lbs.

These arrows are not as closely spine matched as our standard No. 354 to No. 359 1/2.

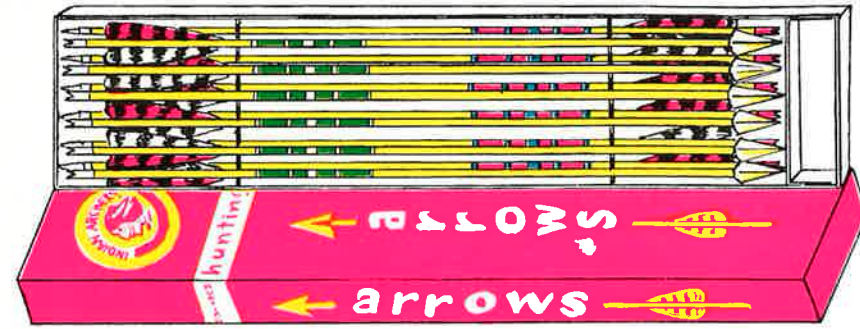

NO. 353 SPECIAL MATCHED SET HUNTING ARROWS

This set comprised of one dozen Hunting Arrows. Six have non-skid field points and six have either Hill's Hornet, Hi-Precision or Whif-fins Bodkin (specify which). These arrows are closely matched in spine and weight. Made of Port Orford Cedar, beautifully crested. Plastic nocks, 5" feathers. 26", 27" and 28" long. Weight per dozen 1 1/4 lbs.

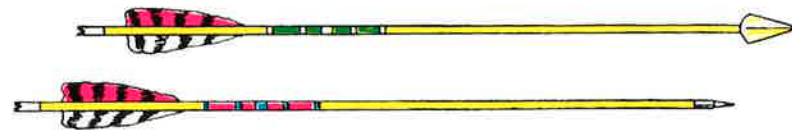

FISHING ARROWS - PLASTIC FLETCHING

Packed 1 doz. in a box.



No. 357P—Fishing Arrow, Birch Shaft. Wt. Doz. 1 1/4 lbs.
No. 357—Fishing Arrow, Lemonwood Shaft, Wt. Doz. 1 1/4 lbs.

No. 357F—Fishing Arrow, Beefwood Footed, Lemonwood Shaft. Available in 24 - 26 and 28" Lengths. Wt. Doz. 1 1/4 lbs.

GLASS HUNTING ARROWS



No. 361G GLASSEAGLE—These arrows are made of the finest selection of woven fibre glass. Closely matched for spine. Hilbre Points. 11/32" Shafts. Plastic nocks. Feathers, 5" in length. Nicely finished and crested. Lengths 26", 27" and 28". Packed 1 Doz. Wt. 2 lbs.

No. 359 1/2 G GLAS-GO—Made of woven fibre glass 11/32" with non-skid points. Beautifully fletched and crested. Closely matched for spine. 26", 27" and 28" long. Packed 1 Doz. Wt. 2 lbs.



No. 355G SUPREME—These arrows are made of the finest selection of woven Fibre Glass 11/32" Shafts. Closely matched for spine. Bodkin, Hill's Hornet or Hi-Precision Points (state which). Plastic

nocks. Feathers, 5" in length. Nicely finished and crested. Lengths 26", 27" and 28". Packed 1 Doz. Wt. 2 lbs.

GLASS TARGET ARROWS



No. 33G ACME—A fine woven glass arrow with parallel sides. 5/16". Nicely crested and fletched, plastic nocks and steel points. Closely matched for spine 24", 26", 28" long. Packed 1 Doz. Wt. 1 1/4 lbs.

NOTE: NO ARROWS GUARANTEED AGAINST BREAKAGE OR DAMAGE AND ARE NOT SUBJECT TO RETURN FOR REPLACEMENT OR CREDIT

TARGET ARROWS



No. 30 EXPERT ARROWS—This is a SPECIAL TOURNAMENT ARROW designed for experts and is BARRELED or STREAM-LINED. 5/16" PORT ORFORD CEDAR SHAFTS. METAL POINTS. Four point BEEFWOOD FOOTINGS. Matched closely in SPINE and WEIGHT, and flies perfectly true without wagging or flirting.

Any Archer will like these arrows. GROUND FEATHERS, PLAS-TIC NOCKS. Beautifully crested and finished. We give customer the right to supply us with pattern of crest desired. Lengths 24" to 28". Packed 1 Dozen. Wt. Doz. 1 1/2 lbs.

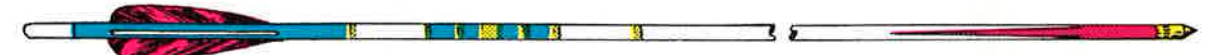

No. 28 OLD PINE FOOTED—This is one of our best arrows. Matched closely for SPINE and WEIGHT and STREAMLINED. 5/16" Shaft made of PORT ORFORD CEDAR. Beautifully crested

and finished. Footed with BEEFWOOD, PLASTIC NOCKS. Metal points. GROUND FEATHERS. Lengths 24 to 28 inches. Packed 1 Dozen. Wt. Doz. 1 1/2 lbs.



No. 32 IDEAL—5/16" PORT ORFORD CEDAR shafts. PLASTIC NOCKS. GROUND FEATHERS. Beautifully crested and finished.

Metal points. STREAMLINED. Lengths 24 to 28 inches. Matched closely for WEIGHT and SPINE. Packed 1 Dozen. Wt. Doz. 1 1/2 lbs.



No. 31 APACHE—This handsome arrow is made of the finest select Port Orford Cedar shaft, matched closely in spine and weight with beautiful cresting and fully dipped in white lacquer, with plastic

speed nock and fletched with ground 4" plain dyed feathers, (not barred). Comes in 24", 26" and 28" lengths. Packed 1 Doz. Wt. Doz. 1 1/2 lbs.

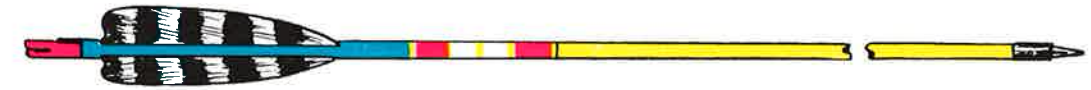

No. 40 LFNS MOHAWK—A very practical arrow made of PORT ORFORD CEDAR. Shaft 5/16". PLASTIC NOCKS. GROUND FEATHERS 4 1/2" long. Non-Skid Points. Nicely crested and finished. Lengths

24 to 28 inches. Packed 1 Dozen. Wt. Doz. 2 lbs. Also packed 1/2 Gross and 1 Gross.



No. 40 BEAR CAT—A very practical arrow made of PORT OR-FORD CEDAR. Shaft 5/16". PLASTIC NOCKS. GROUND FEA-

THERS. METAL POINTS. Nicely crested and finished. Lengths 24 to 28 inches. Packed 1 Dozen. Wt. Doz. 1 1/2 lbs.



No. 39 1/2 BEACON—Fine for beginners. Shaft 5/16". Made of select Port Orford Cedar. Nicely crested and finished. Metal points, GROUND FEATHERS, PLASTIC NOCKS. Lengths 18" to 28". Packed 1 dozen, Wt. 1 1/2 lbs., 1/2 gross Wt. 6 lbs. 1 gross Wt. 12 lbs.

No. 39 1/2 NS—Same as above except with Non-skid field point.
No. 39 1/2 BT—Same as above except with Bullet point.
No. 39 BEACON—Same as No. 39 1/2 except with a self-nock and crest three wide stripes in three colors. Same packing.

SPECIAL NOVICE ARROWS

These practice arrows are excellent arrows, specially produced for those who require good low priced arrows. Crested in three colors, ground feathers with dyed contrasting cock feather, lacquered.

No. 38 Self Nocked Arrows—3 feathers crested and lacquered. Shipping wt. 1/2 Gr. 6 lbs. Shipping wt. 1 gross 12 lbs.

No. 38 1/2—Same arrow as No. 38 but equipped with plastic nock. Shipping wt. 1/2 gross 6 lbs. Shipping wt. 1 gross 12 lbs.

No. 72 CORB.—Here is the finest low end arrow on the market. Comes in a burnished finish with metal tips and plastic nocks. This arrow is crested in two colors and fletched with ground barred feathers with a contrasting dyed cock feather. A sure seller. Weight 1/2 gross 6 lbs. 1 gross 12 lbs.

No. 38 1/2, No. 38 and No. 72 packed in 1/2 gross and gross quantities ONLY.

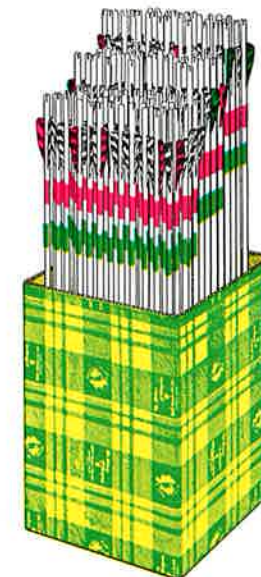

ACCESSORIES



No. 43 DURABLE BOW STRINGS—Italian hemp. Spliced loop on one end and open other end plain. Strong and practical. A good string for cheaper bows. Carded. Made so can be used for 5', 5½', 5' 8" and 6' bows.

No. 43S—Same as 43 except center served. Specify bow length.

ARCHERY HANDBOOKS

No. 46—Useful information that deals with the following: Care of tackle. How to shoot. Standard Rounds. Terminology.
No. 47—Deals with Hunting and Field Shooting.

TARGETS

This Target is very popular and is made with the straw being compressed in a burlap bag and then tufted like a mattress which makes it hard and firm.

TARGET COMPLETE
(Compressed in Burlap with Face)
(Wheat Straw)

No. 50 Wt. 12 lbs. 5" thick, 24" diameter
No. 51 Wt. 30 lbs. 6" thick, 36" diameter
No. 52 Wt. 55 lbs. 7" thick, 48" diameter



No. 60 TARGET STAND—Tripod type. Legs turned round. Smoothly finished and painted green. Has crutch tips to arrest sliding. Woodstock of best Hickory. Wt. 7 lbs.



No. 45 DACRON BOW STRINGS—Strictly handmade with double spliced loop. Center served. Stretched to insure maximum tensile strength. This string is treated with our special formula to insure long service. Plastic Boxed. Made especially for glass bows. When ordering state out to out of loops or for our No. 26-B.

For Bows to 35 lbs.: 50 lbs.: 65 lbs.: 80 lbs.

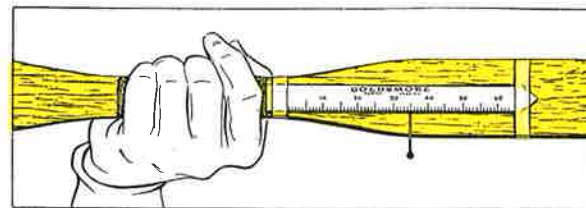

No. 95—GOLDSMIRE BOW SIGHT—Red celluloid mounted on Cork. Calibrated. 7" long.

EXTRA OILCLOTH FACES

Our Oilcloth Target faces are made on heavy dull finish superfine Oilcloth and not on cheap Sign Cloth. They are hand-painted with clearly defined colors. When placed in the sun they have no glare.

Our Slip On faces have skirts sewed on and can be pulled completely over the Target and tied with a draw string in the rear. This special covering protects the Target if it is left in the rain.

(Slip on Type)		(Not Slip on But Flat Type)	
	Diameter		Diameter
No. 53 —Wt. 10 ozs.	24"	No. 53A	24"
No. 54 —Wt. 18 ozs.	36"	No. 54B	36"
No. 55 —Wt. 1 lb., 12 ozs.	48"	No. 55C	48"

BOX TARGET



No. 49
Wheat Straw inserted in a 200-lb. test carton (corrugated.) Carton size 20" x 20" x 4". Packed 6 in master carton. App. wt. 62 lbs.

No. 49F
REPLACEMENT
TARGET FACE

Pkd. 1 dz. in Envelope.

EXTRA PAPER FACES

Bright Colors

Our 24", 36" and 48" Paper Target Faces are made of extremely heavy paper. These are the finest paper faces on the market. They have strong resistance from tearing when caught by the wind. Printed in full color.

No. 58 24" Square, paper
No. 59 36" Square, paper
No. 393 48" Square, paper

ACCESSORIES NEW ITEMS FOR ARCHERS

THE UNIT FEATHERING TOOL

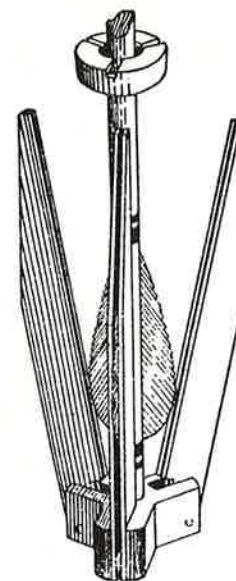

M30—The Improved Unit Feathering Tool consists of three feather-holding arms hinged to a central member. The arms are spaced 120 degrees apart by the dividing head, and are wide enough to hold the feather at right angles to the surface of the shaft.

Each arm consists of two separate members and these may be spread to insert the feather or for cleaning, or to prevent damage to feathers in repair work when one or more feathers are in the arrow. These arms hold the feather by the vane, and if it is desired to hold them more tightly, small paper clips may be employed. Cut or stripped feathers may be used. This tool is designed for use with 5/16ths inch shafts. For smaller shafts, the inner surface of the arms must be filed away until the arms are adjusted to the shaft. For 3/8ths inch shafts, the neck end of the arrow should be tapered until it fits the tool. A little oil or vaseline may be rubbed on the inner surfaces of the arms to prevent them from adhering to the shaft or feathers.

TENON CUTTER

EASY TO USE—ACCURATE—PERFECT RESULTS

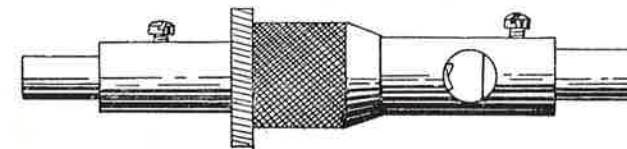

No. M60—This is the ideal tool for shouldering all arrow shafts to attach the points. It will take all sizes of shafts from 5/16 down to 1/4 inch. There is an adjustable stop to limit the depth of the cut and openings to allow any dust which may accumulate to escape. Once the cutter is set it can be locked in position for accurate repeat cuts. This cutter operates best when rotated with a motor or hand drill. It is accurately machined and with reasonable care should last indefinitely.

TAPER TENON TOOL

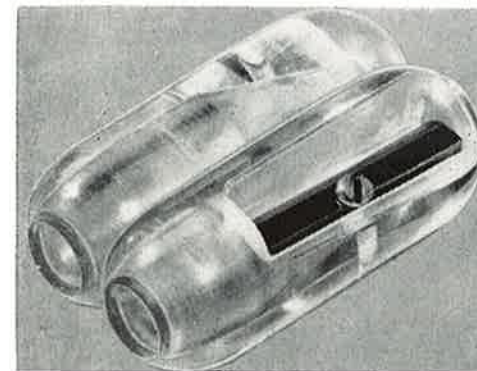

Precision Taper Tenon Tool for cutting tapers on arrow shafts for installation of nocks and arrow points. Molded of high impact plastic. Improved design, side by side cutters for greater leverage and ease of cutting. Side by side cutters, one for nock taper the other for point taper. AVAILABLE IN 3 SIZES.

No. M61-1—for 5/16" parallel point.
No. M61-2—for 5/16" hunting or field taper.
No. M61-3—for 11/32" hunting or field taper.
M-1 cuts 11° (degree) nock taper & parallel point.
M-2 & M-3 cuts 11° (degree) nock taper & 5° (degree) point taper.
ALL MODELS HAVE RAZOR SHARP STAINLESS STEEL BLADES.

ALL LENGTH FLETCHER

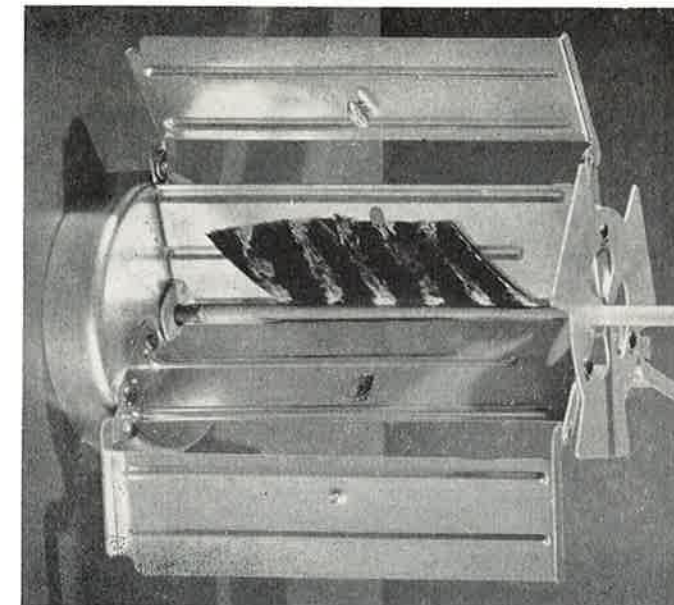

No. 36M—All length Fletcher. Fletches feathers up to 5" long. Handy, accurate, easy to operate. Coat metal parts where feather touches with vaseline to prevent feather from sticking to metal parts.

ALL LENGTH FEATHER BURNER

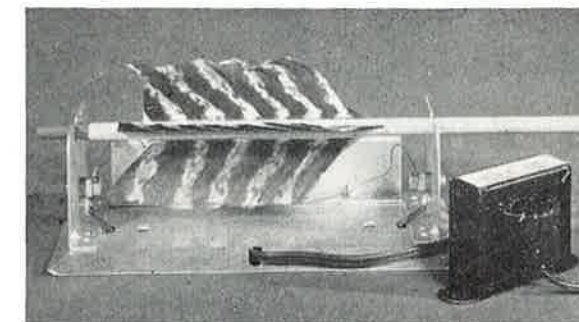

No. 37M—All length feather burner. Does a neat accurate job fast. Equipped with transformer.

ARROW POINT KNURLER

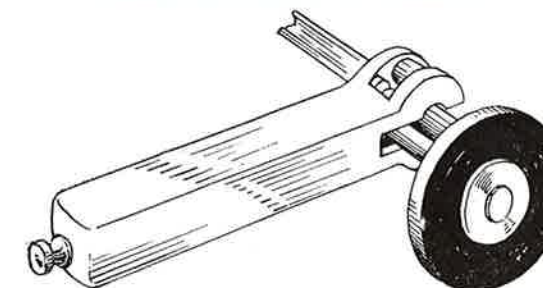

No. 94C—This Arrow Point Knurler is small enough to carry in the pocket or kit, and may be used in the shop, at home or in the field. Can also be used for attaching aluminum nocks. The tool attaches a point better than any other means available to the archer and makes a more attractive arrow. Not recommended for steel piles.

MISCELLANEOUS

No. 336—Waterproof cement for fletching. Large generous tube. Can also be used for household purposes. Will mend practically anything.
No. 337—Linen thread. 2-oz. balls.
No. 338—Bow string wax (special formula). Large round cake.
No. 339—Dacron. 4 oz. spool.

ACCESSORIES

ADJUSTABLE TIME SAVING FEATHERING TOOL

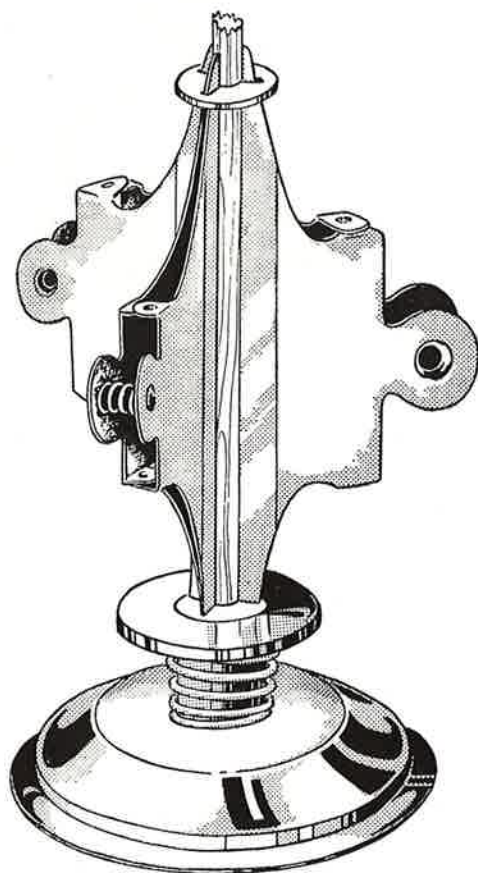

M35—Feathering Tool

Here is a handy, time saving tool for feathering arrows quickly and easily. All three feathers can be applied at once without waiting for others to set. Adjustable—fits all size shafts—straight or tapered. Simple to operate. Three clamps tapered at lower end to fit slot in base of tool hold feathers. As these clamps are forced downward into slots they automatically center upon the shaft no matter what the size. A holding disc with three uniformly spaced slots, to engage upper end of clamps, locks clamps in position, with feathers firmly held against shaft until glue sets.

DIRECTIONS

Put the "cock" feather on first. Adjust all three clamps to same elevation before putting on the holding disc. To remove, press down on the ring at the base, and open and remove clamps.

TENON CUTTER

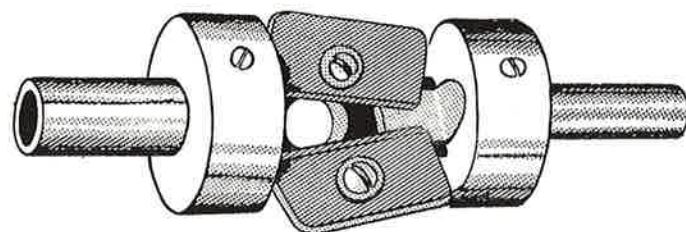

No. 200—New Improved 2 in 1 Adjustable Tenon Cutter. A completely adjustable Taper Tenon Cutter for cutting any size tenon and any taper for arrow points or nocks. Makes the fitting of points and nocks a simple, quick operation. Serves both purposes of tapering nocks and points.

LIGHTNING STRING WHIPPER

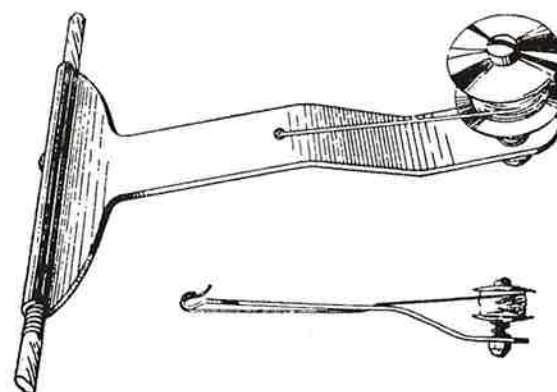

No. 94B—The Lightning String Whipper provides a means of rapidly whipping the string at home or on the field. The bobbin at one end holds the thread, hook at the other end engages the string and holds the tool against loosening or falling away from the string. With this tool the string may be grasped upon either side of the tool and by twirling the tool rapidly about the string, the center can be whipped in a fraction of the time required by other methods.

BOW AND ARROW MATERIAL

LEMONWOOD BOW STAVES FLAT TYPE (Selected Quality)

No. 300— $\frac{3}{4}$ "x1 $\frac{1}{2}$ "x5' 2" with glued on handle and fibre lamination. Tapered.

No. 301— $\frac{3}{4}$ "x1 $\frac{1}{2}$ "x5' 8" with glued on handle and fibre lamination. Tapered.

If bow staves are wanted backed with Rawhide, see Price List.

If backed with White, Black or Red Fibre, see Price List.

(We only carry first quality staves and billets, any grade less than that will make inferior bows.)

FEATHERS

Turkey pointers. These feathers are all selected stock. Ground perfectly and full length. Packed 1 dozen in cellophane bags.

No. 313—Natural barred.

No. 314—Natural white.

No. 315—Dyed barred assorted colors.

NOCKS



No. 325—Plastic nocks. Bright colors. 9/32" and 5/16".

No. 326—Plastic nocks. 11/32". Bright colors.

ARROW POINTS



No. 316—Metal parallel points. Size 9/32" and 5/16".



No. 317—Steel field points. 11/32".



No. 318—Hunting broadhead points. Size for all game.



No. 319 BODKIN Hunting Points. 3 bladed.



No. 321—Bullet Points 5/16".



No. 322—Non skid field points.



No. 323—Fishing Head.



No. 324—Hill's Hornet 3 blade.



No. 327—Hi precision. 3 blade.

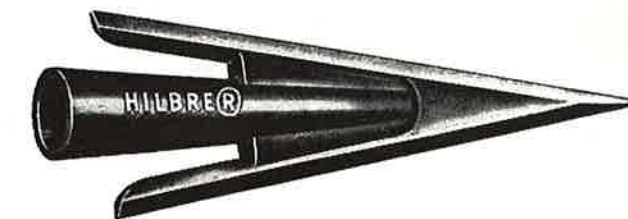

No. 328—Hilbre Hunting Points.

ARROW SHAFTS AND DOWELS

No. 333—Regular selection Port Orford Cedar shafts. Fine quality. Size 11/32", 5/16", 24" to 28" long.

No. 335—Beefwood footings best grade. Size 3/8" square, 7" long. Slotted.

GLOVES - TABS - ARM GUARDS - QUIVERS

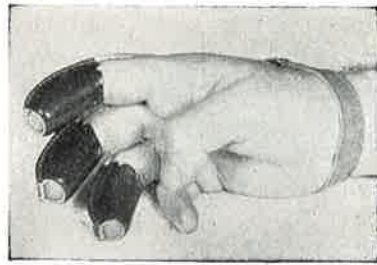

SHOOTING GLOVE

Scientifically designed back prevents glove twisting on hand. Tips skived and shaped to fit fingers perfectly. Flexible chrome leather back. Tips of shell cordovan with molded semi-closed ends. Beautifully embossed. Sizes small, medium, large and extra large.

No. 700—Shooting Glove.

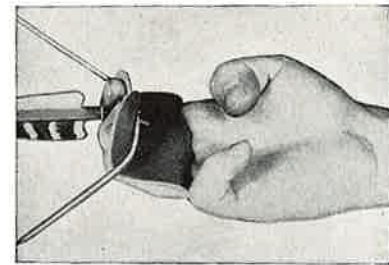

SHOOTING TABS

An inexpensive finger protection. Smooth hard finish leather for clean string release, attractively embossed. Sizes small or large.

No. 703—Shell cordovan leather tab.

No. 704—Cowhide leather tab.



SHOOTING GLOVE

No. 701-S—Scientifically designed back prevents glove twisting on hand. Tips shaped to fit fingers perfectly. Flexible soft leather back. Tips of Cowhide. Sizes: small, medium, large and extra large.

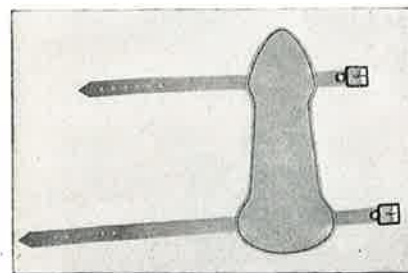

NOVICE ARM GUARD

No. 364—Genuine Leather, nicely stitched and lined with leatherette. A durable wear resistant guard. Fastens with straps and buckles.



TARGET ARM GUARDS

The most popular arm guard in use today. A spring steel stay is sewn in between the face and lining. Elastic straps with quick action hooks hold it on the arm.

No. 708—Cordovan arm guard.

No. 709—Same as No. 708 except cowhide.

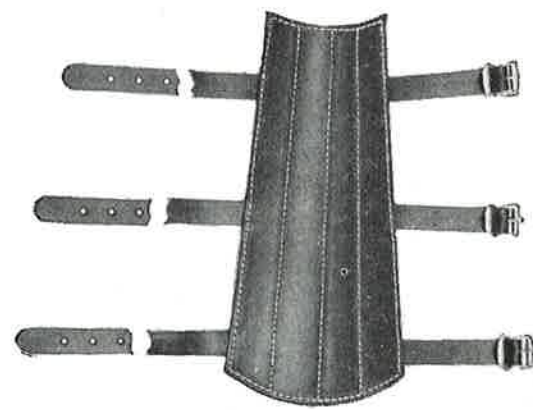

HUNTER ARM GUARD

Designed for rugged hunting and field use. Has steel stay sewn between the face and lining. Available with straps and buckles.

No. 710—Shell cordovan with contrasting leather lining.

No. 711—Same as No. 710 except cowhide.

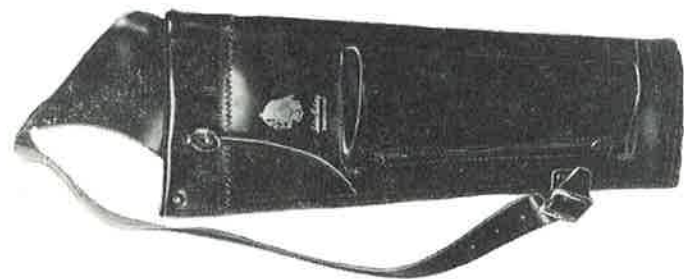

HUNTING QUIVER

Wide throat streamlined quiver, easily holds a dozen large feathered hunting arrows. Comfortable form-fitting shoulder strap. Sets high on shoulder for quick drawing. Puncture proof leather bottom. Beautifully embossed and fitted with decorative cuff for "setting off" top of quiver. With large pocket.

No. 717—Selected heavy cowhide leather. Wt. 17-oz. each.

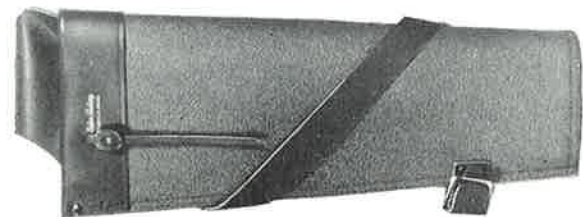

HUNTING QUIVER

No. 718—Wide throat streamlined quiver. Holds 1 doz. Hunting arrows. Sets high on shoulder for quick drawing. Puncture proof leather bottom. Beautifully embossed and fitted with decorative cuff for setting off top of quiver. Made of waterproof, wear resistant leatherette. Bottom, cuff and shoulder strap genuine leather. Weight 14-oz. each.

HUNTING AND TARGET QUIVERS



No. 718 JR.—A fine hunting quiver for the young hunter. Holds 1 doz. Arrows. Made of leatherette with fancy cuff and shoulder strap. This is a fine junior quiver with plenty of eye appeal. Strong and practical. Weight 8-oz. each.

TARGET OR HUNTING QUIVERS



Holds 18 target arrows or 12 hunting arrows. Belt for use around waist for target archery. Special loop attachment for quickly converting quiver to shoulder style for hunting. Attractively embossed. Top trimmed with nicely styled cuff. Heavy cowhide leather.

No. 719—Target or Hunting Quiver. Wt. 8-oz.

No. 720—Same as No. 719 except heavy, double thickness leatherette. Waterproof and wear-resistant. Edges trimmed to contrast. Heavy leather cuff and bottom. Wt. 8-oz.

FORMED TARGET QUIVERS



Designed for either men or women. A deluxe heavy cowhide leather gracefully tapered quiver. Harness designed so that quiver will hang so as not to bump leg when walking. Beautifully embossed.

No. 722—Harness equipped with leather loop for hanging on belt. Wt. 4-oz.

No. 723—Same as No. 722 except the harness is equipped with genuine strap leather belt for use around waist. Wt. 4-oz.

NO. 729 QUIVER



Formed Leatherette Quiver. Sturdily constructed. Popularly priced. 14" long, no belt. Wt. 2-oz.

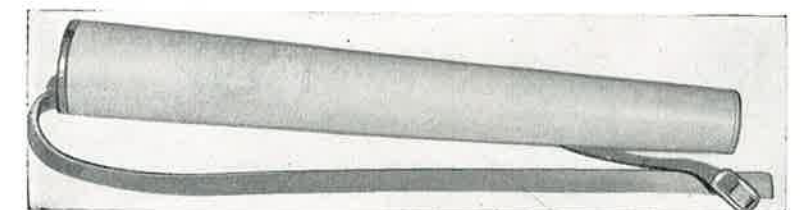

Holds 12 target arrows. Sharply tapered with wide throat. Double thickness, wear-resistant, waterproof leatherette fitted with leather puncture-proof bottom, nicely embossed.

No. 725—Fitted with belt for wearing around waist. Wt. 4-oz.

STANDARD LEATHERETTE QUIVERS



Holds 6 target arrows. Made like the No. 725 large leatherette quiver except smaller. 17" long.

No. 728—Equipped with belt for wearing around waist. Wt. 3-oz.

GROUND QUIVER



No. 716—Made of 5/16" iron. Top loop for arrows is 3 1/2" diameter and screws on shaft. End pointed sharply. Step attached for pushing in ground with foot. Heavily coated with gloss paint. Wt. 8 ozs.

QUIVERS

HUNTING QUIVER

NO. 767

Easily holds 24 large feathered hunting arrows . . . Foam rubber lining in bottom prevents arrow rattle and keeps points sharp . . . large pocket has zipper opening . . . made of Indian Tanned-Leather that does NOT reflect sunlight . . . Double Strap Harness design centers Quiver on back . . . adjustable for individual comfort . . . Divider strap separates cripples or blunts from broadheads . . . puncture proof bottom . . . truly a quiver you will be proud to own and use. Weight 1 lb., 10 oz.



NO. 767

DELUXE TARGET QUIVER

NO. 772

Distinctive Indian style—with Indian bead motif and deep fringe—for either men or women—designed so that quiver will not bump leg when walking—belt clip permits easy-on, easy-off. Made of Indian tanned leather. Foam rubber lining bottom prevents arrow rattle. Puncture proof bottom. Weight 6 ozs. Holds 6 arrows.

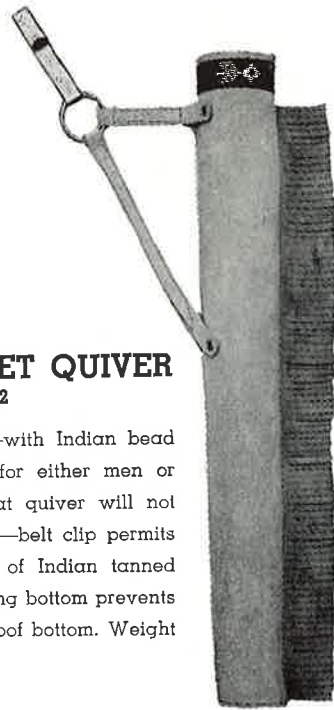

NO. 772

TARGET OR FIELD QUIVER

NO. 769

Designed for use as belt quiver for target archery, and easily converted to shoulder type quiver for field and hunting—Made of Indian tanned leather with Indian bead motif and deep fringed cuff trim—Holds 12 arrows—Foam rubber lining in bottom prevents arrow rattle. Puncture proof bottom. Weight 10 ozs

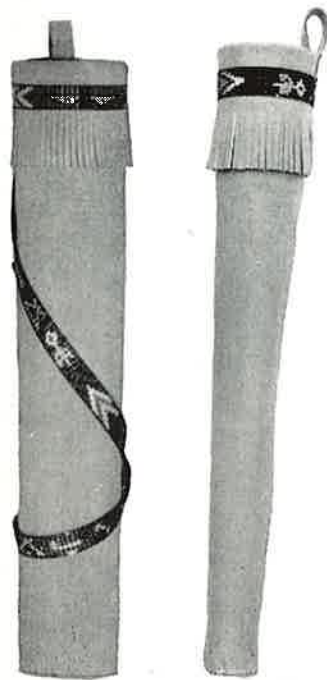

NO. 769

NO. 775

LARGE BELT QUIVER

NO. 775

A target quiver for 12 arrows—Made of genuine arrabuk—strong, waterproof construction—Indian bead motif with deep fringed cuff trim—17" long—Foam rubber lining in bottom to prevent arrow rattle. Puncture proof bottom. Weight 4½ ozs.

HUNTING QUIVER



NO. 768

Easily holds a dozen large feathered hunting arrows—foam rubber lining in bottom prevents arrow rattle and keeps points sharp—made of Genuine Indian Tanned Leather that does NOT reflect sunlight—form fitting shoulder strap holds quiver high on shoulder for quick drawing—18" long—puncture proof bottom—especially recommended for women and teen-agers. Weight 1 lb., 3 ozs.

No. 768JR.—A fine quiver for the young hunter—holds 1 dozen target arrows. Strong and practical, and made of Arrabuk. Same Style as 768 except 14½ inches long. Weight 10 ozs.

QUIVER

NO. 779

Popular priced serviceable target quiver. Made of sturdy waterproof artificial leather. 16" long. Weight 2 ozs.



NO. 779

ARM GUARDS AND GLOVES

HUNTING ARM GUARD

NO. 761

For hunting and field archers—Gives maximum protection with rugged use—Made of genuine Indian Tan Leather with waterproof arrabuk lining. Indian bead motif prevents excessive wear on bow string and lends added wrist protection. Concealed rigid stay for longer wear—Three strap design with buckle fastening. Weight 2½ ozs.



NO. 761

TARGET ARM GUARD



NO. 759

Designed especially for the Target Archer. Made of Indian Tan Leather with waterproof Arrabuk lining . . . Indian Bead motif prevents excessive wear on bow string. Concealed rigid stay for added wrist protection and longer wear. Durable adjustable elastic straps with "quick action" hooks. Weight 1½ ozs.

NOVICE ARM GUARD



NO. 764

Made of Indian tanned leather with lining. Durable elastic straps with single hook fastening. Weight 1 oz.



NO. 750

DELUXE SHOOTING GLOVE

NO. 750

Indian tanned leather—Genuine cordovan tips with molded, semi-closed ends. Completely lined with leather. Beautifully trimmed with Indian bead motif and deep fringe. Adjustable leather strap with snap fastening. Sizes, S, M, L, and XL. Weight 1½ oz.

SHOOTING GLOVE

NO. 751

Indian tanned leather—Tips of select-cordovan with closed end design. Indian bead motif. Adjustable leather strap with snap fastening. Beautifully stitched. Sizes, S, M, L, XL. Weight 1¼ ozs.



NO. 751

SHOOTING GLOVE

NO. 752

Indian tanned leather—Calfskin tips with molded, semi-closed ends. Indian bead motif. Adjustable leather strap with snap fastening. Sizes S, M, L, and XL. Weight 1 oz.



NO. 752

FOOTBALL EQUIPMENT AND PRESSES

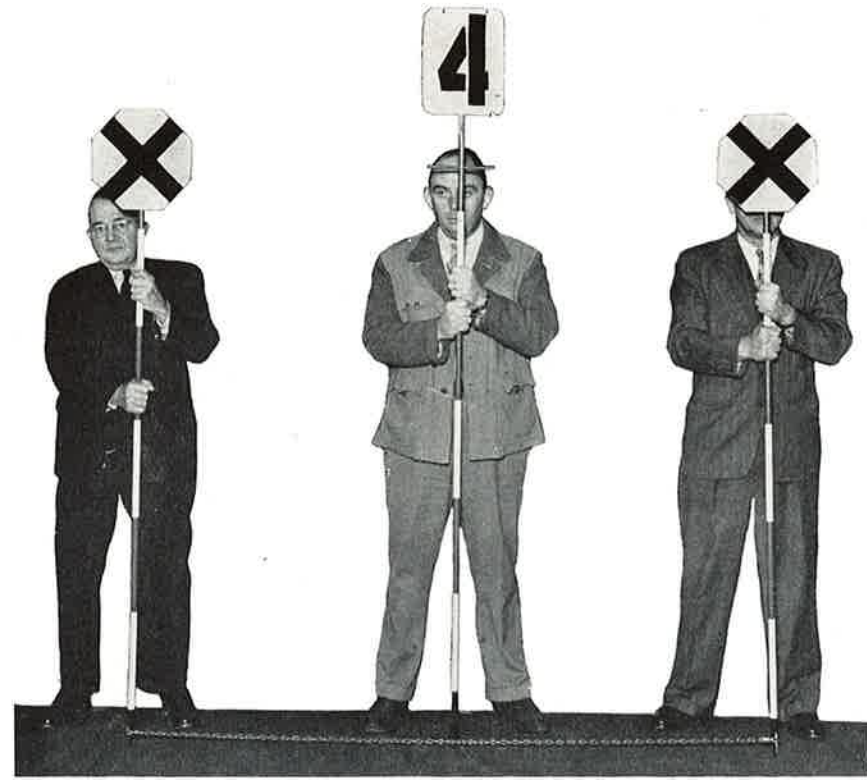

No. 803 TEN YARD LINESMAN'S CHAIN

Made of durable metal rods with plates on top marked for easy visibility for officials or crowd. Has strong non-kinkable chain. Comes with downs marker with large numerals as per illustration. Easy to manipulate. Attractively finished in red, white and black enamel.

SIDE LINE MARKERS FOR GRIDIRONS

No. 804—Size 14" x 14". Made of heavy rubber securely fastened to container which is spiked in ground. Marker collapses if player falls on it and rights itself when released. This feature removes the hazard of danger. Has large 12" **Luminous** numerals, white on black on both sides. Extremely visible for night games.

Full complete set consists of 4/G 4/5 4/10 4/15 4/20 4/25 4/30 4/35 4/40 4/45 2/50.

Not necessary to order full sets. You may order the numerals you wish.

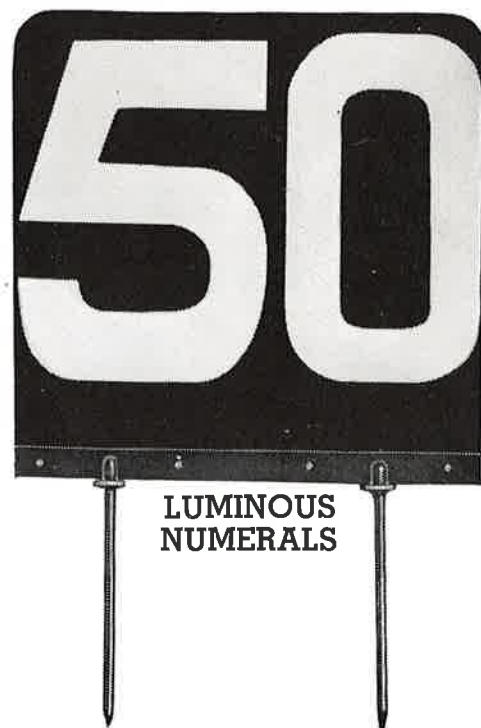

LUMINOUS NUMERALS



GOAL FLAG

No. 806—Non-fading red cloth fastened to metal coil spring staff which collapses when fallen on but immediately rights itself. Extremely visible.

No. 806½—Yellow flags only. No staff. For night games.

GAME AND TOY SECTION - DART GAMES

TWO GAMES IN ONE

These games are mounted on heavy ½" board. The faces are a riot of color. Baseball on one side. Bull's Eye on opposite side. Each board includes three No. 2 size enameled, weighted, needlepointed darts and instructions. Packed one to a shipping carton—suitable for mailing. Weight per board packed complete with instructions and three darts, 4½ lbs. Size 17½" square.

WORLD SERIES BASEBALL DART GAME

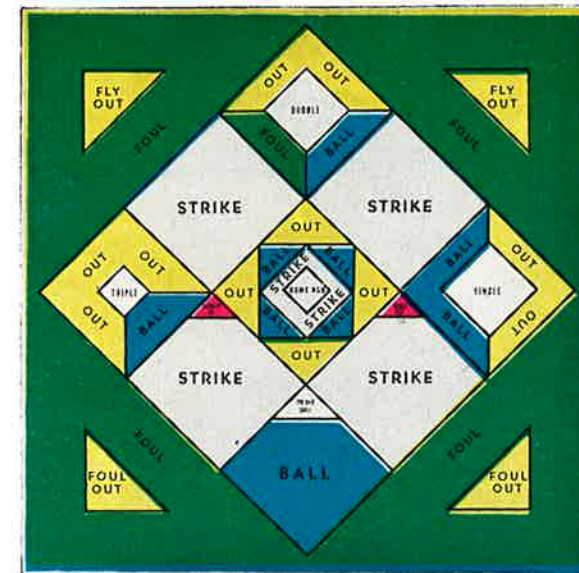

BULL'S EYE TARGET DART GAME

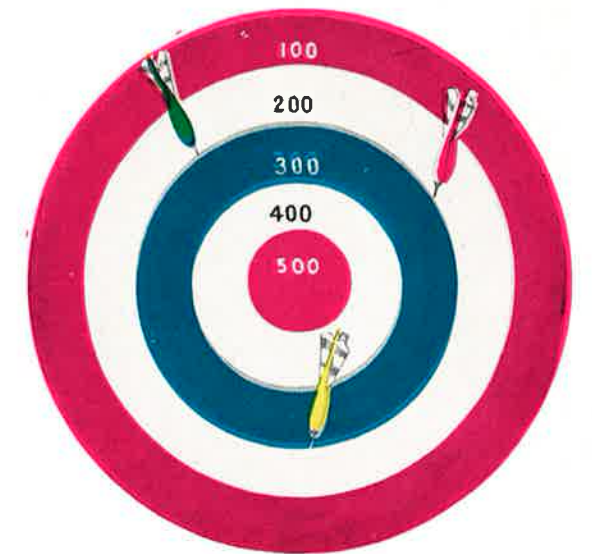

No. 104E—Combination of Bull's Eye Target and World's Series Baseball Dart Games. Wt. Doz. 44-lbs.



INDIANOLA VACUUM DARTS

No. 109G—Large size 6¾" long, 11/16" diameter with large 1¾" rubber vacuum cup. These darts will stick to any smooth non-porous surface. Packed in 3, 6 and 12 dozen.

"OFFICIAL" No. 2 SIZE "SURE FIRE" ENAMELED DARTS No. 106

Barrels in 4 Colors—White, Yellow, Green, Red. Large size, weighted needle-points. Packed on elaborate display target board. Darts packed 3, 6 and 12 dozen, or 6 in a can. Wt. Gr. 12 lbs.

No. 107—Same as above except natural wood. Wt. Gr. 12 lbs.

NO. 108 DART

Heavily weighted official No. 1 dart, the finest Turkey pointer feathers used. Packed 6 in box. 1 gr. in carton. Shipping wt. 6 lbs.

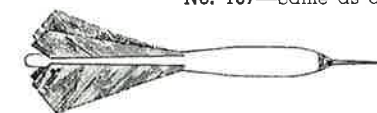

TOY ARCHERY SETS BOXED

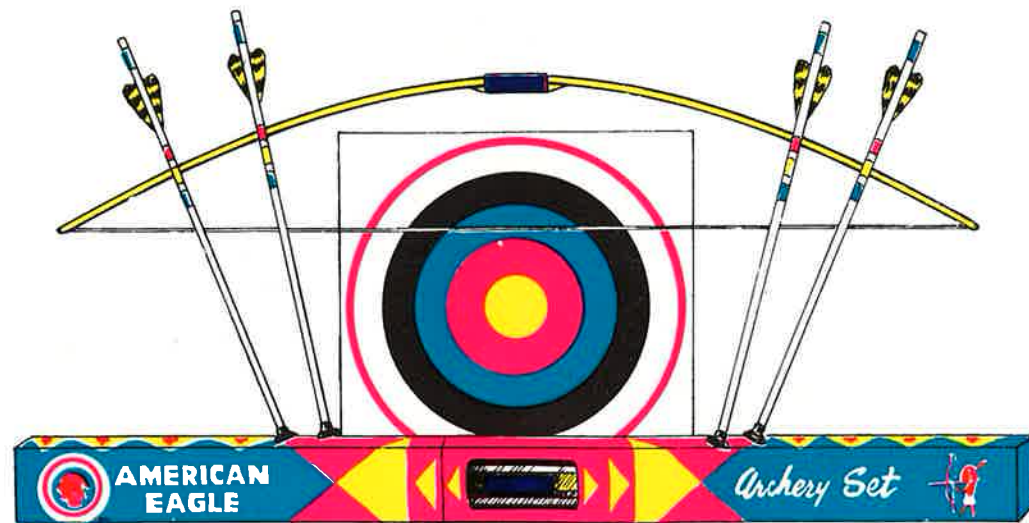

No. 136X—AMERICAN EAGLE ARCHERY SET

The biggest \$2.50 archery set value ever placed on the market. Consists of 48" GENUINE LEMONWOOD BOW properly shaped and nicely finished with Mohair grip. Bow strung with strong string. Equipped with four 21" feathered Arrows and VACUUM TIPS. Packed one dozen to the case. Weight per dozen, 19 lbs.

- No. 136XM—Same as above except metal points.
- No. 136XSB—Same as No. 136X except shaped bow.
- No. 136XMSB—Same as No. 136X except metal points and shaped bow.

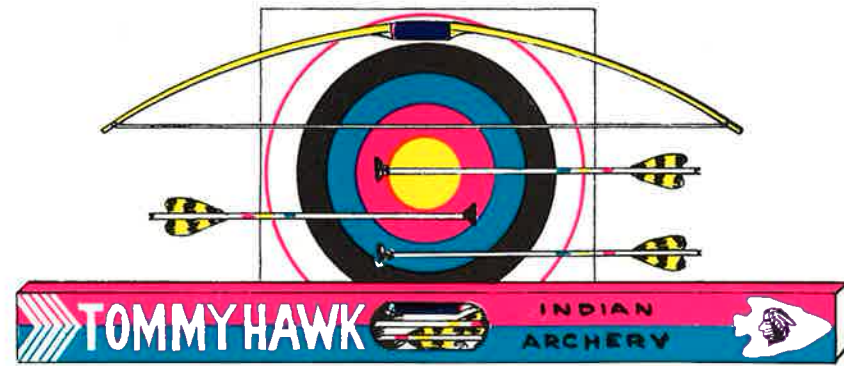

No. 129X—TOMMY HAWK ARCHERY SET

This \$2.00 item strung with strong string consists of a big 42" GENUINE LEMONWOOD BOW properly shaped and nicely finished and has Mohair grip. Equipped with 3 feathered Arrows and RUBBER VACUUM TIPS. Packed one or two dozen to the case. Weight per dozen, 10 lbs.

- No. 129XM—Same as above except metal points.
- No. 129XSB—Same as No. 129X except shaped bow.
- No. 129XMSB—Same as No. 129X except metal points and shaped bow.

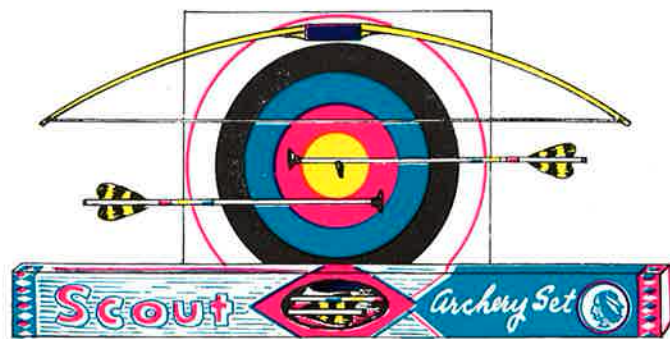

No. 127X—SCOUT SET

A fine archery set that retails for \$1.25 consisting of 36" GENUINE LEMONWOOD BOW properly shaped and nicely finished with Mohair grip. Bow strung with strong string. Equipped with two 16" feathered Arrows with RUBBER VACUUM TIPS. Packed one dozen or two dozen to the case. Weight per dozen 8 lbs.

TOY ARCHERY SETS CARDED



No. 136—AMERICAN EAGLE ARCHERY SET

Consists of 48" GENUINE LEMONWOOD BOW properly shaped and nicely finished with Mohair grip. Bow strung with strong string. Equipped with four 21" feathered Arrows and VACUUM TIPS. Mounted on attractive display board 14½" x 46" and lithographed in several colors. Packed one or two dozen to the case. Weight per dozen, 19 lbs.

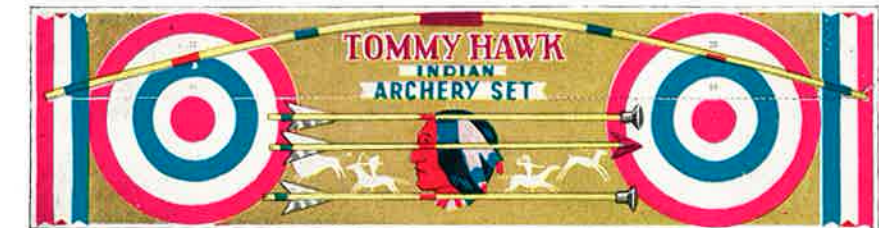

No. 129—TOMMY HAWK ARCHERY SET

This item strung with strong string consists of a big 42" GENUINE LEMONWOOD BOW properly shaped and nicely finished and has Mohair grip. Equipped with 3 feathered Arrows and RUBBER VACUUM TIPS. Mounted on attractive display board 11" x 42". Display board lithographed in several colors. Packed one or two dozen to the case. Weight per dozen, 10 lbs.

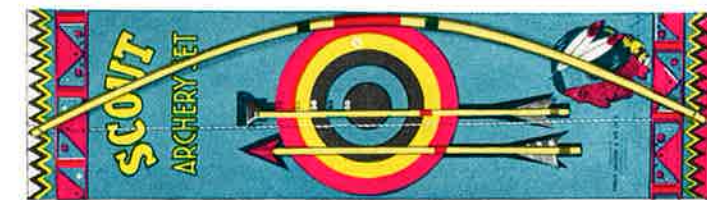

No. 127—SCOUT SET

A fine archery set consisting of 36" GENUINE LEMONWOOD BOW properly shaped and nicely finished with Mohair grip. Bow strung with strong string. Equipped with two 16" feathered Arrows with RUBBER VACUUM TIPS. Mounted on attractive display board 9½"x36". Packed one dozen or two dozen to the case. Weight per dozen 8 lbs.

TOY ARROWS



No. 73 BANNER ARROWS—5/16" Birch Shafts. Vacuum tips 16", 18", 21" long. Striped and feathered with two turkey feathers.

No. 74 BADGER ARROWS—Same as above except with metal Points.

All bows in these sets are made of GENUINE LEMONWOOD and are properly shaped.



No. 251—Bengal Tiger

No. 252—Jungle Elephant

No. 250—Nubian Lion

The BENGAL TIGER, JUNGLE ELEPHANT and NUBIAN LION are very popular items. These animals are mounted on heavy varnished cardboard size 18"x36" and are die cut to shape. On each item is mounted a 36" GENUINE LEMONWOOD BOW

properly shaped and nicely finished with Mohair grip. Four 16" feathered arrows equipped with RUBBER VACUUM TIPS. They are packed one dozen to the case assorted only. Weight per dozen 24 lbs.



WHITE HAWK

No. 121—This Archery Set is one of our newest models. The Target is made of heavy board printed in beautiful colors and varnished. This target is supported by tripod with rubber tips on ends. The Bow is made of Lemonwood 42" long, **new flat type design**, beautifully finished and strung with pure flax string. The four Arrows are made of Birch, feathered with three balloon-type feathers and nicely decorated and equipped with large size vacuum tips. Target 24" round.

This set is individually packed in a shipping container so there is no handling whatsoever upon arrival for reshipping. Packed 1/2 dozen to carton. Weight 1 dozen, 76 lbs.

DART AND ARCHERY GAMES

YELLOW CLOUD



No. 105—Size 24 in. diameter and made of heavy board, on front of which is handsome target in five vivid colors. Equipped with five beautifully feathered Darts with VACUUM TIPS. This Dart Board is positively harmless and exceptionally entertaining. Packed individually suitable for mailing. Weight each 3 lbs.

HIAWATHA



No. 122—This is another popular number. Target 24 in. diameter, of heavy board, printed in five vivid colors and varnished. Bow 36 in. long, **new flat type design**, beautifully finished and strung with pure flax string. Four Birch Arrows are furnished vacuum tipped, beautifully finished and decorated and feathered with three balloon type feathers. Packed one to box, suitable for mailing. Weight each 3 1/2 lbs.

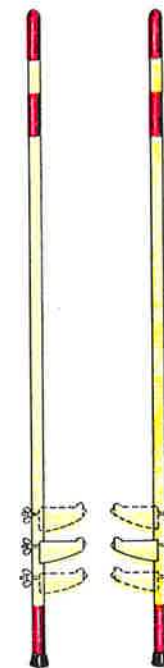

No. 123 BLACKFOOT—Our newest easel game. The target is made of 5-ply corrugated board about 1" thick upon which is a target face in five beautiful colors. Supported with a hardwood folding tripod striped and varnished. Bow is made of lemonwood 42" long. Flat type design with strong string. The four nicely decorated arrows are birch, feathered with three balloon-shape feathers and have Metal Points. Target is 24" in diameter. Handbook. This set is individually packed in a shipping container so there is no handling whatsoever upon arrival for reshipping. Packed 1/4 dozen, 1/2 dozen, 1 dozen to carton. Weight 1 dozen, 70 lbs.

No. 124—Five-ply corrugated targets only for No. 123 set. 24" diameter. Wt. 29 lbs. Dz.

This target is also suitable for throwing needle pointed darts.

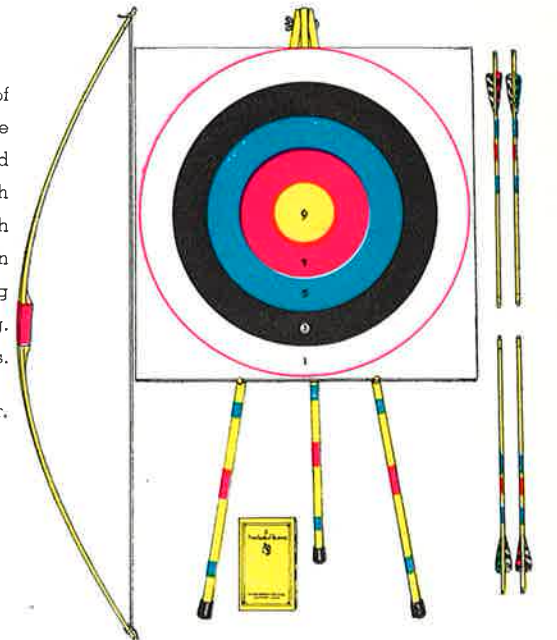

JUNIOR TARGET STAND

Constructed of Hickory dowels—plated hardware—rubber leg rests and Hickory rests. Excellent for use with No. 125, 126 or 128 Dart Boards. Now used in No. 123 Blackfoot Game. Pkd.

No. 124 T.S. 1/2 dz. Wt. 7 lbs.

NAVAJO STILTS

No. 131—Here is an item that is always popular. Appeals to boys and girls alike. Made of round, selected ash or hickory rods, beautifully finished. Flanged steps adjustable to three heights. Ends equipped with cushioned rubber crutch tips. Size 1 1/2 in. diameter, 6 ft. long. Individually boxed. Wt. per pr., 5 lbs., 10 ozs.



COMBINATION DART  BOARDS

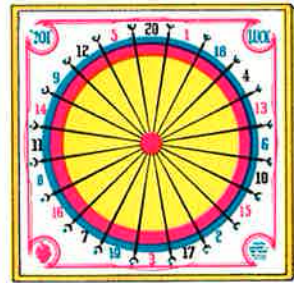

20 POINT



BULLS EYE

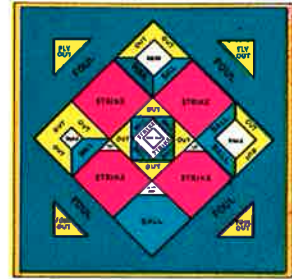

BASEBALL

These Dart Boards are constructed of the toughest 5 ply corrugated board and will take severe punishment. Our experience with our No. 123 Blackfoot over many years has convinced us that our customers demands for a low priced dart board of this material is

justified. We now present the following combinations of these Dart Boards. Each Board equipped with 3 No. 108 Darts. Instructions included. Size of Board 18"x18"x1".

- No. 125 COMBINATION DART BOARD — 1 Side Bulls Eye and 1 Side Baseball.
- No. 126—COMBINATION DART BOARD — 1 Side Bulls Eye and 1 Side 20 Point.
- No. 128—COMBINATION DART BOARD — 1 Side Baseball and 1 Side 20 Point.

Packed 1/2 Dz. each or ass't to carton, shipping wt. 9 lbs.

BAT-MINTON

Popular Action Items

These games for either in or outdoor play where space will permit, such as gyms, large rooms, and recreational basements. As outdoor items they have no equal. Ideally suited for home lawns, camps and public playgrounds. Practical, beautifully finished and decorated. Rugged and durable.



No. 117H—This is a very practical and entertaining set. Consists of 2 15-in. plywood bats, 2 lively shuttlecocks with die cut white feathers. 1 10-ft. tape and instructions. Beautifully boxed in cellophane. For extra shuttlecocks see No. 113.

No. 113 SHUTTLECOCKS—Die cut yellow feathers. Rubber bases. Can be used in or outdoors. By use of rubber band bird can be speeded up or retarded to suit atmospheric conditions. Packed 3, 6 or 12 dozen to carton.

No. 113 1/2—Extra packets of feathers for No. 113 (6 in packet).

LOW PRICED ARCHERY SETS

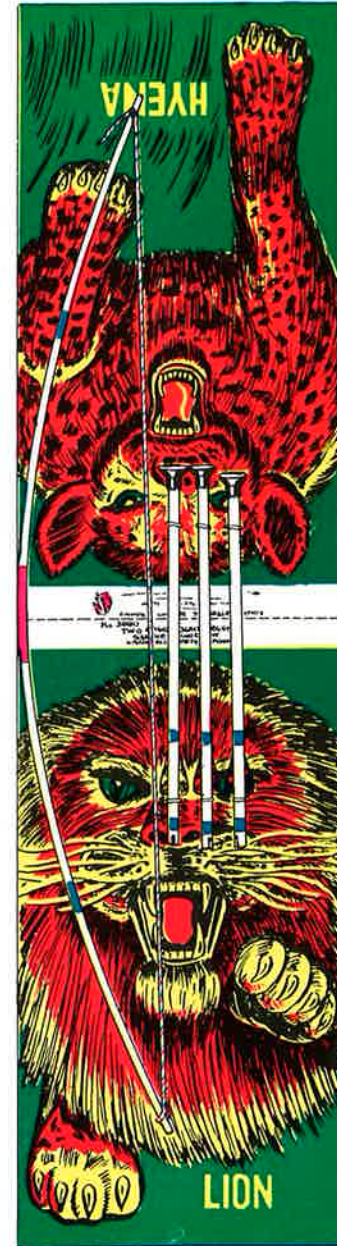

No. 3000 COMBINATION LION AND HYENA SET—Consists of one 36" Hickory Bow striped in two colors and varnished. Three Arrows 16" long. Striped, Feathered. Green vacuum tips. Mounted on 11" x 43" colorful V-type display card, when folded makes two animal targets.
Packed 1/2 Gross to Carton. Weight 50 lbs.
Packed 1/4 Gross to Carton. Weight 26 lbs.



No. 2000 COMBINATION TIGER AND GORILLA SET—Consists of one 30" Hickory Bow striped in two colors and varnished. Two Hardwood Arrows 12" long with green vacuum tips. Mounted on 9 1/2"x35" V-type colorful display card, when folded makes two animal targets.
Packed 1/2 Gross to Carton. Weight 39 lbs.
Packed 1/4 Gross to Carton. Weight 21 lbs.



No. 1000 COMBINATION LEOPARD AND BEAR SET—Consists of one 24" Hickory Bow striped in two colors and varnished. One Hardwood Arrow 10" long with green vacuum tip. Mounted on 6"x24" V-type colorful display card, when folded makes two animal targets.
Packed 1 Gross to Carton. Weight 25 lbs.
Packed 1/2 Gross to Carton. Weight 13 lbs.

FINEST IN ARCHERY EQUIPMENT AND TOYS BY THE WORLD'S LARGEST MANUFACTURER OF ARCHERY EQUIPMENT.

Fold target on center line. Stand on ground in inverted "V" shape. This makes a wonderful knock-over target with both animals in an upright position.

Indian Archery

Hits The Bull's Eye

whether you

Shoot It Or Sell It

The Greatest Name In Archery

To Our Customers and Friends

The Indian Archery and Toy Corporation was organized in 1927. From its incipiency we have continuously toiled, created, and brought to the market Archery products of beauty and improved from a practical point of view to give Archers throughout the land the best that can be expected. We feel we have always been the leaders in this respect.

We have thoroughly established our good will by giving all of our customers fine products, good service, and cooperating to the fullest extent.

We guarantee every piece of merchandise to stand up and give service. We have thousands of satisfied jobber, dealer, and department store accounts and new accounts coming along every day.

We, also, wish to thank our loyal customers for the fine support they have given us.

Home of-

INDIAN ARCHERY & TOY CORPORATION

"The Archery of Champions"

