

# ASSORTMENT INDEX

<b>Acorn Cap Nuts</b> .....	2712
<b>Adapters, Hydraulic</b> .....	2590-2591,2593-2594
<b>Adhesives</b> .....	2646
<b>Aligator Clamps</b> .....	2508
<b>Air Fittings</b> .....	2575-2582B
<b>Allthread</b> .....	2610
<b>Anchors</b> .....	2555, 2558, 2716
<b>Batteries</b> .....	2513-2514
<b>Battery Lugs</b> .....	2507, 2509-2511
<b>Battery Terminals</b> .....	2510
<b>Bolts</b>	
Body.....	2643
Carriage.....	2606, 2612, 2639
Elevator.....	2599B
Flange.....	2595, 2598-2599A, 2600, 2606
JIS Head.....	2595
Metric Flange.....	2598-2599A
Metric Hex Cap.....	2597-2598, 2599C 2607-2609,2640
SAE Hex Cap.....	2596,2601,2603,2605,2612
Stainless.....	2632-2635, 2637,2640
USS Hex Cap.....	2596,2602,2603,2604,2611
<b>Brass Fittings</b>	
Brakeline Adapters.....	2576, 2578-2579, 2724-2725
Compression.....	2573
Hose Barbs.....	2576
Inverted Flare.....	2574
NTA.....	2575, 2580-2581
Pipe.....	2574,2580
Press-to-Connect.....	2577
Prestolok.....	2578
Reusable Hose Ends.....	2582
SAE Flare.....	2573
<b>Bristle Discs</b> .....	2572A
<b>Cable Wire Ties</b> .....	2506, 2512, 2728, 2731
<b>Caplugs</b> .....	2594
<b>Carbide Burs</b> .....	2726
<b>Carriage Bolts</b> .....	2606, 2612, 2639
<b>Chain Links</b> .....	2539
<b>Circuit Breakers</b> .....	2511
<b>Clevis Pins</b> .....	2536
<b>Concrete Screw Anchors</b> .....	2555, 2558
<b>Constant Torque Clamps</b> .....	2555
<b>Copper Lugs</b> .....	2507, 2510-2511
<b>Copper Washers</b> .....	2729
<b>Cotter Pins</b> .....	2537-2538, 2704
<b>Delphi Packard Terminals</b> .....	2506
<b>Deutsch Terminals</b> .....	2509
<b>Dies &amp; Taps</b> .....	2566
<b>Disc Lock Washers</b> .....	2621
<b>Dowel Pins</b> .....	2629
<b>Drill Bits</b> .....	2570
<b>Drywall Screws</b> .....	2521, 2709
<b>E-Rings</b> .....	2545, 2705
<b>Easy Outs</b> .....	2726
<b>Elevator Bolts</b> .....	2599B
<b>Extractors</b> .....	2713
<b>Fender Washers</b> .....	2620,2632
<b>Files</b> .....	2567
<b>Flange Bolts</b> .....	2595, 2598-2599A 2600, 2606
<b>Flap Discs, Mini</b> .....	2572B
<b>Flap Wheels</b> .....	2565
<b>Flat Head Socket Caps</b> .....	2625, 2629, 2640
<b>Fuel Line Connectors</b> .....	2649, 2730
<b>Fuses</b> .....	2644, 2646, 2647, 2717, 2720 2724, 2726-2728
<b>Grease Fittings</b> .....	2645, 2721
<b>Grommets</b> .....	2645, 2721
<b>Hairpins</b> .....	2535, 2705
<b>Heat Shrink Tubing</b> .....	2513, 2514, 2701
<b>Heli-Coils</b> .....	2642
<b>Hole Saws</b> .....	2569
<b>Hose Clamps</b> .....	2552-2556
<b>Hose Menders</b> .....	2554
<b>Hydraulic Adapters</b> .....	2590-2591,2593
<b>Hydraulic O-rings</b> .....	2592, 2731
<b>Jam Nuts</b> .....	2617
<b>John Guest Fittings</b> .....	2579
<b>Keenserts</b> .....	2569
<b>Keystock</b> .....	2540
<b>Krimp-N-Seals</b> .....	2503-2504, 2700
<b>Locknuts</b> .....	2615-2618
<b>Loom Clamps</b> .....	2554,2557
<b>Low Head Socket Caps</b> .....	2631
<b>Lugs</b> .....	2507, 2509-2511
<b>Lynch Pins</b> .....	2535
<b>Machine Screws</b>	
Flat Head.....	2528, 2633
Metric.....	2529
Pan Head.....	2525-2526,2635
Round Head.....	2526-2527
Stainless.....	2633, 2635

# ASSORTMENT INDEX

Mini Flap Discs.....	2572B	Star Washers.....	2621, 2712
Mounted Stones.....	2565	Stover Locknuts.....	2615-2616
Nutserts.....	2570	Studs, Metric.....	2641
Nuts, Small.....	2616	Switches.....	2511
Nylon Flat Washers.....	2725	Tap & Dies.....	2566
Nylon Locknuts.....	2615-2618	Tapes.....	2648
Nylon Ties.....	2506, 2508, 2512, 2728, 2733	Taps.....	2713
O-Rings.....	2546-2549, 2592, 2705, 2731	Tee Nuts.....	2712
Paint Markers.....	2716	Tek Screws.....	2519-2520, 2522, 2523 2639, 2709, 2729
Pal Nuts.....	2730	Terminals	
Pipe Fittings.....	2584-2589	Battery.....	2510
Reciprocating Blades.....	2569, 2572E, 2713	Delphi Packard.....	2506
Retainers.....	2643	Deutsch.....	2509
Retaining Rings.....	2544-2545, 2708	Non-Insulated.....	2505
Rivets.....	2559	Nylon.....	2500-2501, 2700
Roll Pins (Spring Pins).....	2533-2534, 2704	Plastic.....	2501-2502, 2700
Rolon Discs.....	2564, 2571-2572D	Shrink.....	2503-2504, 2700
S&D Bits.....	2569	Wire Nuts.....	2505
Sanding Discs.....	2564, 2571-2572B	Thin Nylon Locknuts.....	2618
Screwdriver Bits.....	2529, 2716	Thread Cutting Screws.....	2521
Screw Extractors.....	2713	Threaded Rod.....	2610
Self Threading Nuts.....	2724	Trim Clips.....	2643
Serrated Flange Bolts.....	2595	Trim Cut Discs.....	2572B
Set Screw.....	2627-2628, 2631 2638, 2701-2702	Tubing Clamps.....	2554, 2557
Sheet Metal Screws		Two-Ear Clamps.....	2554
Black.....	2522	Vacuum Connectors.....	2641, 2720
Hex Head.....	2517, 2636	Valve Caps.....	2730
Oval Head.....	2638	Well Nuts.....	2729
Pan Head.....	2518, 2636	Washers	
Tek Screws.....	2519-2520, 2522 2523 2639, 2709, 2729	Copper.....	2729
Thread Cutters.....	2521	Disc Lock.....	2621
Shrink Terminals.....	2503-2504, 2700	Fender.....	2620, 2632
Shrink Tubing.....	2513, 2514, 2701	Nylon.....	2725
Shoulder Bolts.....	2624	Star Shakeproof.....	2621, 2712
Snap Pins.....	2535	Wire Ends	
Snap Rings.....	2544-2545, 2708	Delphi Packard.....	2506
Socket Head Cap Screws.....	2624-2626 2630, 2637, 2640A	Non-Insulated.....	2505
Button Head.....	2626, 2634	Nylon.....	2500-2501, 2700
Flat Head.....	2625, 2629, 2640	Plastic.....	2501-2502, 2700
Low Head.....	2631	Shrink.....	2503-2504, 2700
Solder Pellets.....	2731	Wire Nuts.....	2505
Spring Lock Pins.....	2533-2534, 2704	Wire Nuts.....	2505
Springs.....	2642	Wire Ties.....	2506, 2508, 2512, 2728, 2733
Square Head Set Screws.....	2631	Wire Wheels.....	2650
Stainless Products.....	2632-2640A	Woodruff Keys.....	2536, 2704
		Wood Screws.....	2520
		Zerks.....	2645, 2721

# STORAGE BINS

## OPEN HOLE BINS (Heavy Duty Metal)

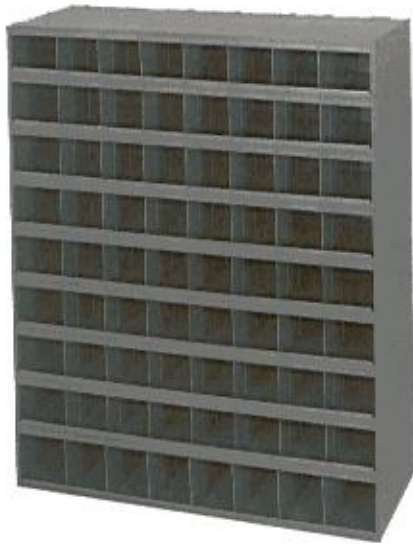

38177 (72 HOLES)



38190 (42 HOLES)



38176 (40 HOLES)

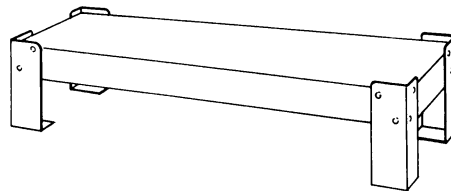

38288,  
41432 & 41431

J&B #	OPENINGS	HEIGHT	WIDTH	DEPTH
38176	40	23-7/8"	33-3/4"	12"
*38190	42	42"	33-3/4"	12"
*38177	72	42"	33-3/4"	12"
38288	BASE STAND FOR EITHER HEIGHT = 5-3/4		#38176, #38177, #38190, OR #38418	
41432	BASE STAND FOR ZZNS40		HEIGHT = 4"	

\* 72 AND 42 HOLE BINS CANNOT SHIP UPS.

# STORAGE BINS

## 4 DRAWER RACK (Heavy Duty Metal)

- Features four slide-out drawers for use with large drawers.

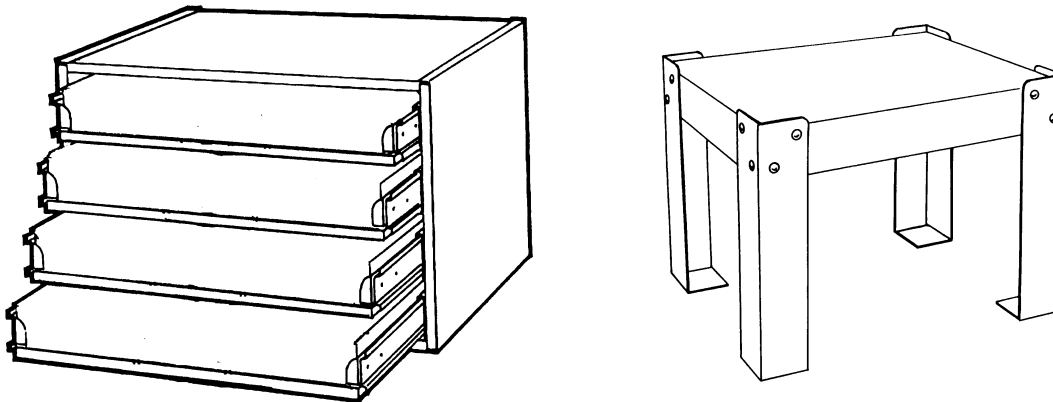

J&B #	DESCRIPTION	HEIGHT	WIDTH	DEPTH
38409	H/D RACK	15"	20"	15-3/4"
38417	RACK	15"	20-1/4"	12-1/2"
38283	H/D BASE STAND	15-5/8"	20-5/8"	16-1/4"
38287	BASE STAND	15-5/8"	20-5/8"	12-5/8"
38277	H/D BASE STAND	5-3/4"	20-5/8"	16-1/4"

## 18 DRAWER CABINET (Heavy Duty Metal)

- Each drawer includes 2 dividers.

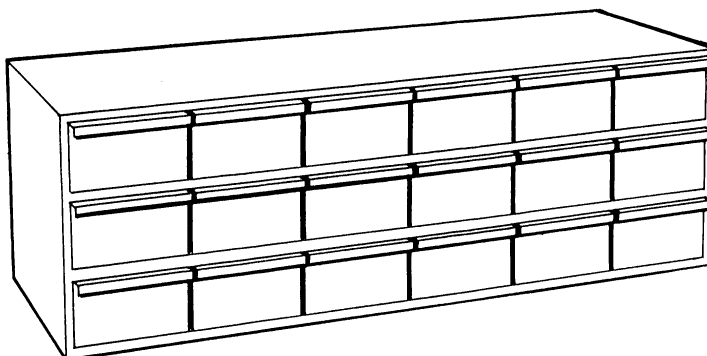

EXTRA DIVIDERS		
J&B #	Material	QTY
41306	Metal	18
* 41307	Plastic	12

\* FOR DURHAM CABINETS

J&B #	HEIGHT	WIDTH	DEPTH
38418	10-7/8"	33-3/4"	11-5/8"

# STORAGE BINS

## LARGE DRAWERS (Heavy Duty Metal)

- Round bottom “Scoop-Out” compartments.
- Excellent for storing small parts of all kinds.
- Comes with handle and pull down catch.

DIMENSIONS		
HEIGHT	WIDTH	DEPTH
3”	18”	12”



38279 12-HOLE



38278 20-HOLE



38280 21-HOLE



38178 24-HOLE



38282 32-HOLE

## ADJUSTABLE LARGE DRAWERS (Heavy Duty Metal)

### VERTICAL

- Four vertical partitions; each partition is slotted on 1” centers.
- 9 dividers are provided with each box.



EXTRA DIVIDERS	
J&B #	QTY
41305	9

J&B #	QTY
38281	EA

### HORIZONTAL

- Six horizontal partitions; each partition is slotted on 2-1/4” centers.
- 12 dividers are provided with each box.



EXTRA DIVIDERS	
J&B #	QTY
41304	12

J&B #	QTY
38293	EA

# STORAGE BINS

---

## KEYSTOCK RACK

(Heavy Duty Metal)



J&B #	HEIGHT	WIDTH	DEPTH
38444	12"	12-1/4"	6-1/4"

---

## THREADED ROD RACK

(Heavy Duty Metal)



J&B #	HEIGHT	WIDTH	DEPTH
38443	24"	24-1/8"	6-7/8"

---

## GRAVITY FEED DISPENSER

(Heavy Duty Metal)



J&B #	HEIGHT	WIDTH	DEPTH
38291	17-5/8"	20-3/4"	7-1/2"

# STORAGE BINS

---

## CABLE TIE BIN (Heavy Duty Metal)



J&B #	HEIGHT	WIDTH	DEPTH
38292	12-5/16"	18-3/16"	3"

# STORAGE BINS

## HOSE CLAMP RACKS

(Heavy Duty Metal)

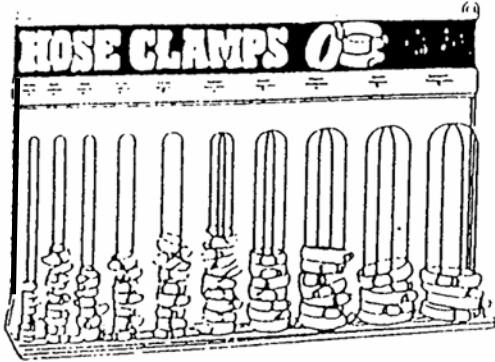

J&B #	QTY
38295	EA

\*This rack is capable of holding industry sizes 4,5,6,10,12,16,20,28,32, and 36

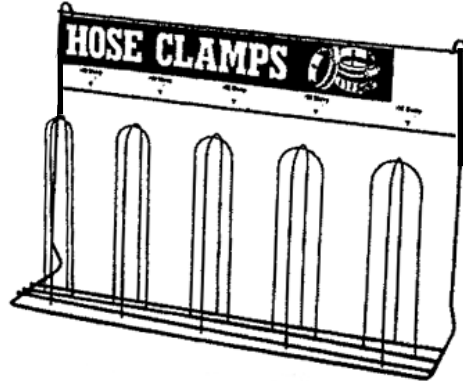

J&B #	QTY
38296	EA

\*This rack is capable of holding industry sizes 40,48,52,56 and 72

## WIRE RACK & HOSE RACK

(Heavy Duty Metal)

- Equipped with four (4) removable dowels.
- 30" ruler on the outer side of the rack assists in quick measuring.

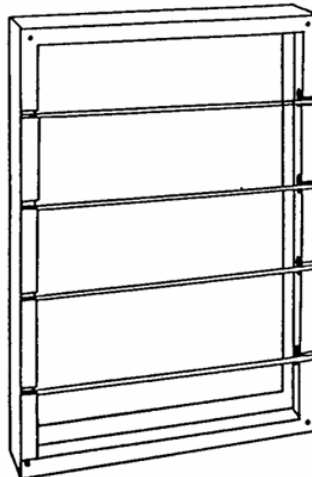

J&B #	HEIGHT	WIDTH	DEPTH
38289	37-1/8"	26-1/8"	6"





# STORAGE BINS

## AEROSOL / UTILITY CABINETS

- Featuring two adjustable shelves and a lock attachment.
- Padlock not provided.
- Keyhole slots allow easy wall mounting.



J&B #	DESCRIPTION	HEIGHT	WIDTH	DEPTH
38696	UTILITY CABINET	32-3/4"	19-7/8"	14-1/4"

## BULB CABINET

- 32 clear, rugged plastic trays.

J&B #	SIZE	QTY
20942	19" W 26-3/4" H 4" D	EA



## LARGE PLASTIC BOXES

- Resists solvents such as gasoline, oil and most common chemicals.
- Comes with 2 snap latches to assure closure.

6 HOLE

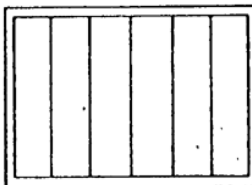

J&B #38270

12 HOLE

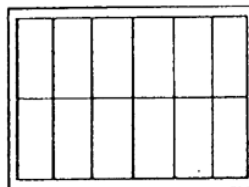

J&B #38271

18 HOLE

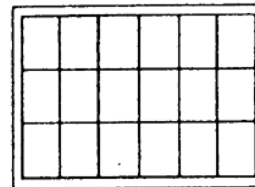

J&B #38272



DIMENSIONS		
HEIGHT	WIDTH	DEPTH
2-5/16"	13-1/8"	9"

# STORAGE BINS

## SMALL PLASTIC BOXES

- Resists solvents such as gasoline, oil and most common chemicals.
- Comes with 2 snap latches to assure closure.



6 HOLE

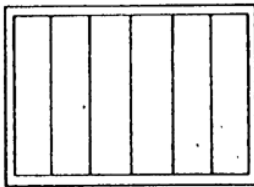

J&B #38284

12 HOLE

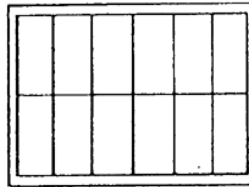

J&B #38285

18 HOLE

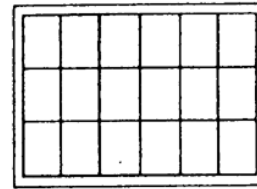

J&B #38286

DIMENSIONS		
HEIGHT	WIDTH	DEPTH
1-3/4"	11"	6-3/4"

## SMALL DRAWER COMPARTMENT BOX

- Prime cold rolled steel; durable gray powder coat finish.
- Keyhole slots on back allow mounting on walls and panels.
- Offset handle allows easy transport.
- Holds 5 boxes. (Not included)

J&B #	HEIGHT	WIDTH	DEPTH
38426	11-1/4"	10-3/4"	6-3/4"

Bolt holes permit secure stacking

Offset handle allows easy transport.



Keyhole slots on back allow mounting on walls and panels.

Prime cold rolled steel

Durable gray powder coat finish

Optional Model 313 Locking Hinge sold separately, padlock not included

# STORAGE BINS

## DRILL DISPENSERS

- Sizes stamped into metal on front of each compartment.

J&B #	DESCRIPTION	HEIGHT	WIDTH	DEPTH
38690	FRACTIONAL	7-3/4"	14-5/8"	7-3/8"
* 38691	NUMBER	7-3/4"	14-5/8"	7-3/8"
* 38692	LETTER	7-1/4"	14-1/2"	7-1/4"

\* J&B #38690 is in stock, J&B #38691 & #38692 must be special ordered

#38690 - Holds 29 fractional drill sizes 1/16 to 1/2 by 64ths.

#38691 - Holds 60 number drill sizes 1 to 60.

#38692 - Holds 26 letter drill sizes A to Z.



## EMPTY DRILL INDEX BOXES

J&B #	HOLES SIZES ...
20561	1/16 - 1/4 by 64ths
20562	1/16 - 1/2 by 64ths
20563	1/16 - 1/2 by 32nds
20564	#1 - 60
20565	A - Z
41183	9/16 - 1" (8 sizes)



## EMPTY DRILL BIT HOLDER

- Weather – tight / waterproof - indestructable

J&B #	SIZE	HOLES SIZES
9705	JOBBERS LENGTH	1/16 - 1/2 by 64ths
9706	MECHANICS LENGTH	1/16 - 1/2 by 64ths

\*\*\* 9705 & 9706 comes empty



# STORAGE BINS

## TAP DISPENSERS

- Sizes stamped into metal on front of each compartment.

J&B #	DESCRIPTION	HEIGHT	WIDTH	DEPTH
38693	FRACTIONAL	7-3/4"	14-5/8"	7-3/8"
*38694	MACHINE SCREW	7-3/4"	14-5/8"	7-3/8"
38695	METRIC	7-3/4"	14-5/8"	7-3/8"

#38693 Holds 10 coarse and 10 fine fractional tap sizes from 1/4 through 1".

#38694  
(NON-STOCK) Each size holds taper, plug, bottoming, spiral point taps. 60 compartments. Holds machine screw sizes 2-56 through 12-28.

#38695 Holds 29 popular metric sizes from 3mm x .50 through 18mm x 2.50.

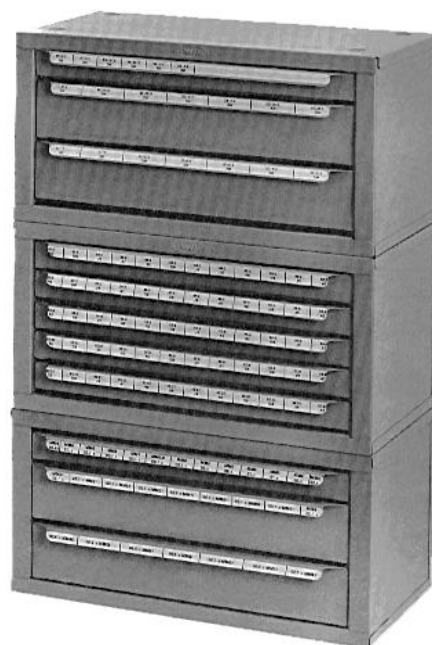

# SALES AIDS

---

J&B #	ITEM	QTY
0001	HAT	EA
0003	PEN	EA
0005	SCRATCH PADS	EA
0007	BOLT GAUGES	EA
0008	WANT LIST	EA
0009	LIGHTERS	EA
0011	DRINK MUG 22 OZ.	EA
0013	PRODUCT CARD	50
0014	NSN PRODUCT CARD	EA
0015	TAP & DRILL CHART	50
0017	J&B FOIL LABELS (WITHOUT NAME)	EA
SP	J&B FOIL LABELS (WITH NAME)	ROLL / 1000
0037	J&B DECALS (10" x 8")	EA
0041	PLASTIC SLEEVE BACKINGS	EA
* 0042	BIN BOX 4 x 2 x 12	50/CS
* 0043	BIN BOX 4 x 3 x 12	50/CS
* 0045	BIN BOX 4 x 4 x 12	50/CS
* 0047	BIN BOX 4 x 6 x 12	50/CS
* 0049	BIN BOX 4 x 10 x 12	25/CS
* 0050	BIN BOX 4 x 12 x 12	50/CS
* 0053	BIN BOX 4 x 3 x 18	25/CS
* 0054	BIN BOX 4 x 4 x 18	50/CS
* 0055	BIN BOX 4 x 6 x 18	50/CS
* 0056	BIN BOX 4 x 10 x 18	25/CS
0051	J&B BROWN ENVELOPES	25
0052	DRILL SET LABELS FOR CABINETS	10

\* ONLY FULL CASES CAN BE SHIPPED UPS/FEDEX



# LABELS

BOLTS	
J&B #	ITEM
0019	USS G-5 HEX CAPS (187)
0161	USS G-5 HX CAP SMALL PACK (102)
0020	USS G-5 BIG HEX CAPS (63)
0021	SAE G-5 HEX CAPS (171)
0162	SAE G-5 HX CAP SMALL PACK (69)
0022	SAE G-5 BIG HEX CAPS (33)
0023	USS G-8 HEX CAPS (175)
0024	USS G-8 BIG HEX CAPS (132)
0025	SAE G-8 HEX CAPS (160)
0026	SAE G-8 BIG HEX CAPS (86)
0029	8.8 METRIC HEX CAPS (189)
0184	JIS 8.8 METRIC HEX CAPS (12)
0035	STAINLESS STEEL HEX CAPS (118)
0036	CARRIAGE BOLTS (74)
0180	CARRIAGE BOLTS STAINLESS (25)
0185	CARRIAGE BOLTS G-5 (19)
0085	FLANGE BOLTS (87)
0179	SERRATED FLANGE BOLTS (23)
0136	10.9 METRIC FLANGE BOLTS (35)
0176	10.9 JIS METRIC FLANGE BOLTS (52)
0086	LAG SCREWS/SHIELDS (49)
0102	10.9 METRIC HEX CAPS (163)
0107	EYE BOLTS (10)
0108	ELEVATOR BOLTS (16)

HYDRAULICS	
J&B #	ITEM
0084	37°METRIC FLARE ADAPTERS (30)
0087	71 SERIES (58)
0088	78 SERIES (50)
0089	43 SERIES METRIC (80)
0090	43 SERIES (281)
0091	55 SERIES (44)
0092	20 SERIES (63)
0093	90 SERIES (5)
0094	88 SERIES (7)
0095	91 SERIES (15)
0096	37° FLARE ADAPTERS (246)
0097	37° FLARE O-RING ADAPTERS (157)
0098	FEMALE SWIVEL ADAPTERS (62)
0099	HYDRAULIC PIPE ADAPTERS (105)
0105	SEALOK FITTINGS (104)

NUT & WASHERS	
J&B #	ITEM
0080	STOVER LOCKNUTS (23)
0081	NYLON LOCKNUTS (33)
0189	NYLON LOCKNUTS G-8 (20)
0082	CASTLE / SLOTTED NUTS (20)
0109	HIGH NUTS (9)
0110	HEAVY HEX NUTS (17)
0111	JAM NUTS (22)
0112	ROD COUPLING NUTS (12)
0113	KEPS NUTS (11)
0114	SERRATED FLANGE NUTS Z/P (15)
0115	BEVELED WASHERS (4)
0116	FENDER WASHERS (24)
0183	FENDER WASHERS STAINLESS (12)

PIPE	
J&B #	ITEM
0031	BLACK PIPE 1-8" – 1" (156)
0135	BLACK PIPE 1-1/4" – 2" (80)
0032	GALVANIZED PIPE (123)
0103	HEAVY DUTY BLACK PIPE (106)

SOCKET PRODUCTS	
J&B #	ITEM
0072	SOCKET CAP SCREWS (140)
0119	SOCKET CAP FINE SCREWS (36)
0073	FLAT SOCKET CAPS (82)
0120	BUTTON HEAD SOCKET CAPS (39)
0074	SHOULDER BOLTS (57)
0078	METRIC SOCKET CAPS (79)
0181	METRIC SOCKET CAPS STAINLESS (24)
0178	METRIC FLAT SOCKET CAPS (27)
0121	HEX SOCKET PIPE PLUGS (7)
0122	DOWEL PINS (59)
0123	STAINLESS SOCKET CAPS (40)

MISC.	
J&B #	ITEM
0100	TUBE CLAMPS (16)
0101	CHEMICALS (OLD)
0106	BULBS (74)
0117	WHEEL NUTS & STUDS (17)
0118	DRYWALL SCREWS (11)
0124	WIRE ROPE CLIPS & THIMBLES (18)
0125	SNAP & LYNCH PINS (12)
0126	CLEVIS HOOKS (10)
0127	CLEVIS PINS (43)
0128	RIVETS (26)
0133	HOSE CLAMPS STANDARD (25)
0134	HOSE CLAMPS LINER (13)
0182	HOSE CLAMPS ALL STAINLESS (18)
0186	CONSTANT TORQUE CLAMPS (11)
0167	ROLON CONDITIONING DISCS (14)
0168	ROLON SANDING DISCS (20)
0169	PRIMARY WIRE (48)
0170	WIRE LOOM (6)
0187	LOOM CLAMPS CARBON STEEL (10)
0188	LOOM CLAMPS STAINLESS STEEL (8)

BRASS	
J&B #	ITEM
0060	BRASS PIPE (118)
0061	BRASS SAE 45° FLARE (87)
0062	BRASS NTA (74)
0063	BRASS COPPER TUBE (46)
0064	REUSEABLE-AIR BRAKE (21)
0065	PUSH-LOK (36)
0066	BRASS COMPRESSION (96)
0067	BRASS INVERTED FLARE (89)
0166	TRUCK VALVES (6)
0132	HOSE BARBS (48)
0175	HEATER HOSE BARBS (6)
0069	VALVES (19)
0165	BALL VALVES (8)
0068	PRESTOLOK (23)
0177	PRESS-TO-CONNECT (92)
0199	PRESTOMATIC (19)

WHEEL WEIGHTS & ANCHORS	
J&B #	ITEM
0070	REGC WHEEL WEIGHTS (12)
0139	AWC WHEEL WEIGHTS (12)
0140	MCC WHEEL WEIGHTS (12)
0141	LHC WHEEL WEIGHTS (12)
0142	TSC WHEEL WEIGHTS (12)
0143	ENC WHEEL WEIGHTS (8)
0144	FNC WHEEL WEIGHTS (12)
0145	IAWC WHEEL WEIGHTS (12)
0129	SLEEVE ANCHORS (15)
0130	WEDGE ANCHORS (14)

# ZZNS ITEMS

---

J&B #	DESCRIPTION	QTY
ZZNS48	Teflon Hose 48" 919-12 with 42214 on each end	EA
ZZNS115	Repair kits Parker # 14K	EA
ZZNS126	DEL702 1/4 Fabric loom	100FT/RL
ZZNS146	HX CP GR8 NF 1 x 3 plain (1/4Kg only)	65/BX
ZZNS147	HX CP GR8 NF 1 x 3-1/2 plain (1/4Kg only)	60/BX
ZZNS148	HX CP GR8 NF 1 x 4 plain (1/4Kg only)	50/BX
ZZNS272	Gold Plate Weekend Paint K346 Net Wt 11 Oz.	6/CS
ZZNS510	Water filter pleated cartridge 20 micron	24/CS