



FEATURES

- Output voltage 6V_{pp}
- Linear amplifier
- Flat gain up to 30 GHz
- Single voltage power supply
- Low group delay variation

APPLICATIONS

- LiNbO₃ & InP modulators
- OFDM, RoF, Phase modulation
- Research & Development

OPTIONS

- Heat-sink
- Low output voltage version for EAM

RELATED EQUIPMENTS

- MX-LN-40, MXAN-LN-40 modulators
- MBC-AN Automatic Bias Controllers

The Photline DR-AN-40-MO is a wideband RF non-inverting amplifier module designed for analog applications at frequencies up to 40 GHz.

The DR-AN-40-MO is characterized by a low Noise Figure and a linear transfer function whose 1 dB compression point is above 15 dBm. It exhibits flat Group Delay and Gain curves with reduced ripple over the entire bandwidth.

The DR-AN-40-MO operates from a single power supply for safety and ease of use, and offers gain control over 3 dB. It comes in a compact housing with V type RF connectors and with an optional heat sink.

This amplifier module is ideally suited to drive optical modulators for analog applications.

Performance Highlights

Parameter	Min	Typ	Max	Unit
Cut-off Frequencies	50 k	-	40 G	Hz
Output Voltage	-	-	6.3	V _{pp}
Gain	-	26	-	dB
Saturated Output Power	-	-	20	dBm
Output power 1 dB comp	15	17	-	dBm
Noise Figure	3	-	5	ps

Measurements for $V_{bias} = 8 V$, $V_{amp} = 1.5 V$, $V_{xp} = 2.2 V$, $I_{bias} = 300 mA$

DC Electrical Characteristics

Parameter	Symbol	Min	Typ	Max	Unit
Supply voltage (fixed)	V_{bias}	7	8	9	V
Current consumption	I_{bias}	-	300	350	mA
Gain control voltage	V_{amp}	0	1.5	1.7	V
Cross point control voltage	V_{xp}	0	2.2	2.3	V

Electrical Characteristics

Parameter	Symbol	Condition	Min	Typ	Max	Unit
Lower frequency	f_{3dB} lower	-3 dB point	-	-	50	kHz
Upper frequency	f_{3dB} upper	-3 dB point	36	40	-	GHz
Gain	S_{21}	Small signal	-	26	-	dB
Gain ripple	-	< 40 GHz	-	± 1.5	-	dB
Input return loss	S_{11}	50 MHz < f < 30 GHz	-	-10	-	dB
Output return loss	S_{22}	50 MHz < f < 30 GHz	-	-10	-	dB
Isolation	S_{12}	50 MHz < f < 30 GHz	-	-60	-	dB
Output power 1 dB	P_{1dB}	2 GHz < f < 20 GHz	15	17	-	dBm
Saturated power	P_{sat}	f < 20 GHz	-	20	-	dBm
Output voltage	V_{out}	Linear	0	4.5	-	V_{pp}
		Maximum swing	0	6.3	-	
Noise figure	NF	f < 1 GHz	5	-	-	dB
		1 GHz < f < 26 GHz	3	-	5	
Power dissipation	P	-	-	2.4	3.2	W

Conditions: $V_{in} = 0.5 V_{pp}$, $T_{amb} = 25^\circ\text{C}$, 50 Ω system

Absolute Maximum Ratings

Stresses in excess of the absolute maximum ratings can cause permanent damage to the device. These are absolute stress ratings only. Functional operation of the device is not implied at these or any other conditions in excess of those given in the operational sections of the data sheet. Exposure to absolute maximum ratings for extended periods can adversely affect device reliability.

Parameter	Symbol	Min	Max	Unit
RF input voltage	V_{in}	-	0.63	V_{pp}
Supply Voltage	V_{bias}	0	9	V
DC current	I_{bias}	0	350	mA
Gain control voltage	V_{amp}	0	1.7	V
Output power control voltage	V_{xp}	0	2.3	V
Power dissipation	P_{diss}	-	3.2	W
Temperature of operation	T_{op}	0	+50	$^\circ\text{C}$
Storage temperature	T_{st}	-20	+70	$^\circ\text{C}$

S_{21} and Group Delay Parameter Curve

Conditions: $V_{bias} = 8\text{ V}$, $V_{amp} = 1.5\text{ V}$, $V_{xp} = 2.2\text{ V}$, $I_{bias} = 300\text{ mA}$

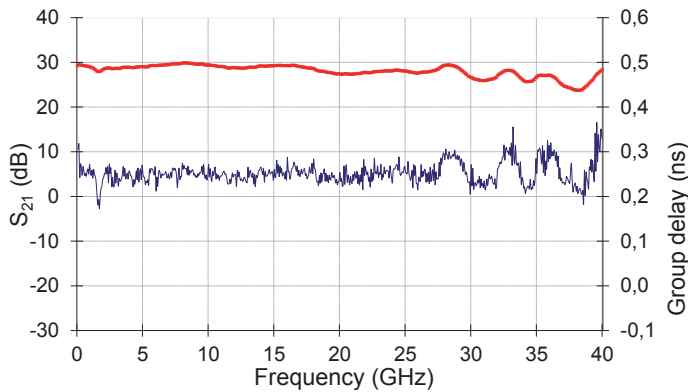

S_{12} Parameter Curve

Conditions: $V_{bias} = 8\text{ V}$, $V_{amp} = 1.5\text{ V}$, $V_{xp} = 2.2\text{ V}$, $I_{bias} = 300\text{ mA}$

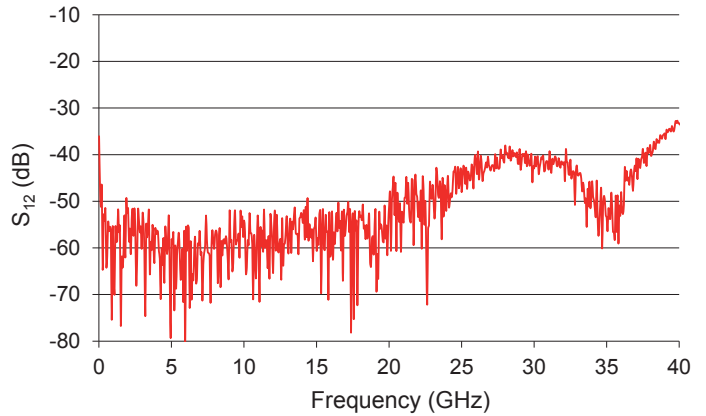

S_{22} Parameter Curve

Conditions: $V_{bias} = 8\text{ V}$, $V_{amp} = 1.5\text{ V}$, $V_{xp} = 2.2\text{ V}$, $I_{bias} = 300\text{ mA}$

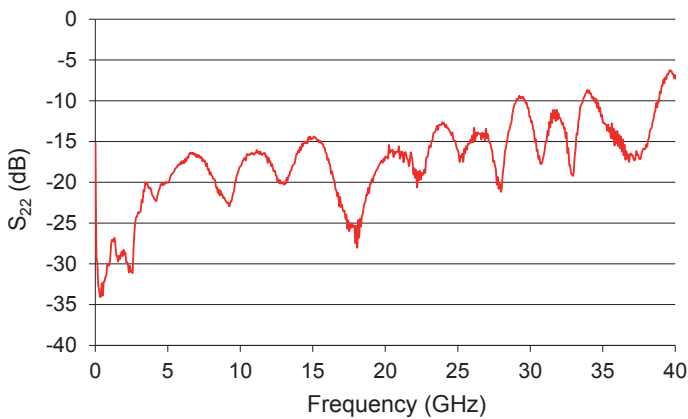

S_{11} Parameter Curve

Conditions: $V_{bias} = 8\text{ V}$, $V_{amp} = 1.5\text{ V}$, $V_{xp} = 2.2\text{ V}$, $I_{bias} = 300\text{ mA}$

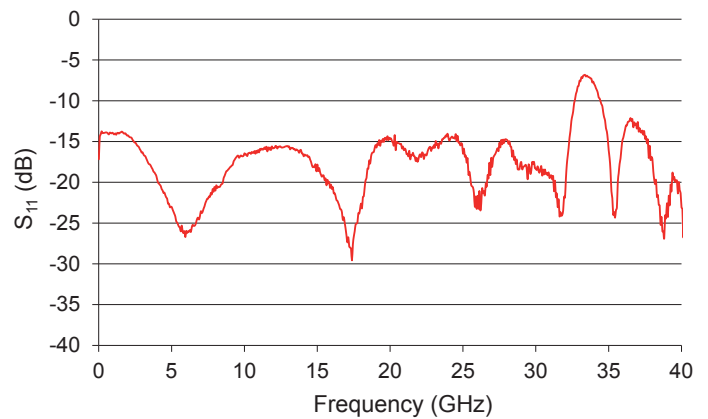

Saturated Output Power Curve

Conditions: $V_{bias} = 8\text{ V}$, $V_{amp} = 1.5\text{ V}$, $V_{xp} = 2.2\text{ V}$, $I_{bias} = 300\text{ mA}$

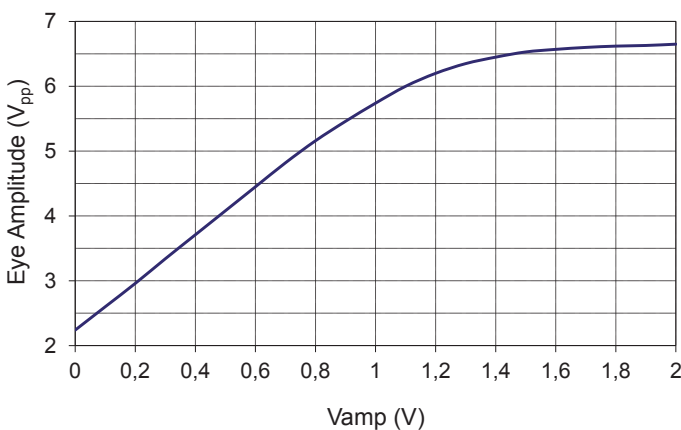

Noise Figure Curve

Conditions: $V_{bias} = 8\text{ V}$, $V_{amp} = 1.5\text{ V}$, $V_{xp} = 2.2\text{ V}$, $I_{bias} = 300\text{ mA}$

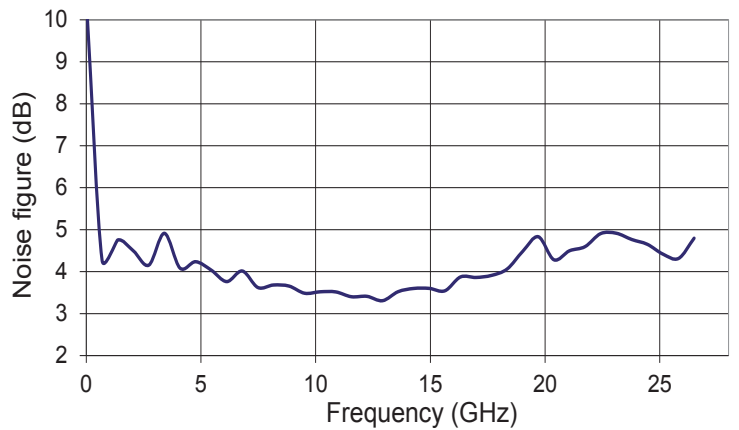

Electrical Schematic Diagram

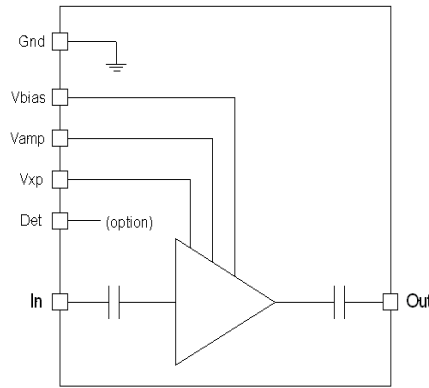

Mechanical Diagram and Pinout

All measurements in mm

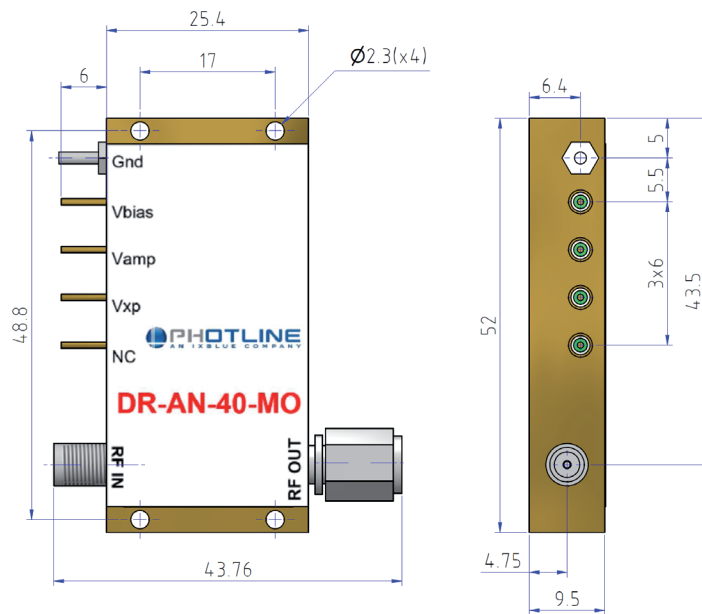

The heatsinking of the module is necessary. It's user responsibility to use an adequate heatsink. Refer to page 6 for ixBlue recommended heatsink.

PIN	Function	Unit
IN	RF In	V connector female
OUT	RF Out	V connector male
V_{bias}	Power supply voltage	Set a typical operating specification
V_{amp}	Output voltage amplitude adjustment	Adjust for gain control tuning
V_{xp}	Output voltage cross point adjustment	Adjust for cross point control tuning

Mechanical Diagram And Pinout With HS-MO2 Heatsink

All measurements in mm

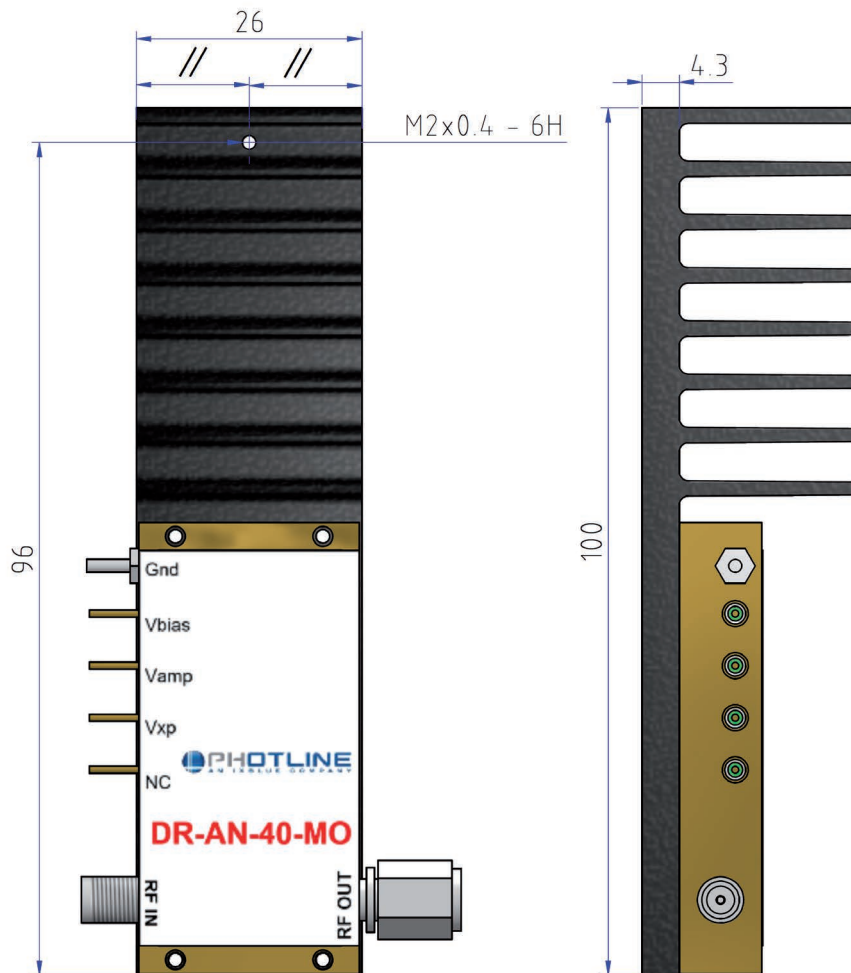

About us

ixBlue Photonics includes ixBlue ixFiber brand that produces specialty optical fibers and Bragg gratings based fiber optics components and ixBlue Photline brand that provides optical modulation solutions based on the company lithium niobate (LiNbO₃) modulators and RF electronic modules.

ixBlue Photonics serves a wide range of industries: sensing and instruments, defense, telecommunications, space and fiber lasers as well as research laboratories all over the world.

3, rue Sophie Germain
25 000 Besançon - FRANCE
Tel. : +33 (0) 381 853 180 - Fax : + 33 (0) 381 811 557

ixblue reserves the right to change, at any time and without notice, the specifications, design, function or form of its products described herein. All statements, specification, technical information related to the products herein are given in good faith and based upon information believed to be reliable and accurate at the moment of printing. However the accuracy and completeness thereof is not guaranteed. No liability is assumed for any inaccuracies and as a result of use of the products. The user must validate all parameters for each application before use and he assumes all risks in connection with the use of the products