

# Design of a Novel IoT Based Cardiovascular Patient health and Surrounding Weather Monitoring and Controlling System

<sup>1</sup>K.Prathyusha, <sup>2</sup>Lakshmi Naryana Thalluri, IE Member.

<sup>1</sup>M.Tech. Student, Dept. of ECE, Andhra Loyola Institute of Engineering and Technology, Vijayawada, A.P, India.

<sup>2</sup>Assistant Professor, Dept of ECE, Andhra Loyola Institute of Engineering and Technology, Vijayawada, A.P, India.

**Abstract**— In this communication, we have designed a novel IoT based Cardiovascular patient health and surrounding weather monitoring and controlling system. In this design we have provided an internet to six advanced sensor's using communication module which will help to upload the sensors data in to the cloud for further processing. Overall the communication module and sensors are interface with the controller with 16 MHz clock frequency. In this proposed system for physical data acquisition overall six sensor i.e. UV ray's based pulse detecting sensor, electrodes based ECG sensor, strain gauge based load cell (Range: 0-50kg), IC based temperature sensor(Range: -55°C to +150°C), capacitance based humidity sensor(Range: 20% to 95%) and resistance based gas sensor(Range: 20—20000PPM) are used. A Wi-Fi module is used as a communication device to provide the internet to sensors and its operating frequency is 2.4GHz with IEEE 802.11b/g/n standard. The Wi-Fi module can transmit and receive the data with 115200 baud rate. Here, TCP protocol is used to establish the channel between the IoT system and the database in the cloud. In cloud to store the data in the respective fields we have used a PAAS technique, PAAS should provide the runtime environment for deployment tools and application.

**Keywords**—Internet Protocols, IoT, Sensors, Communication Modules, Cloud Computing.

## I. INTRODUCTION

IoT concept was firstly followed by MIT AUTO-ID Labs. Whereas it also investigation there proposed by the use of a wireless sensor network and radio frequency identification technology to accomplish object localization. In 2005 international Telecommunication union they gave a final report [2]. It defines that IoT is the collection of objects that are connect with each other through network. The IoT analysis can be fit for the some particular departments (i.e. urban administration, health monitoring, industrial monitoring, enterprise services, infrastructure formation, public protection, smart homes. By 2025 we are hoped-for IoT nodes are communicate most of the things, plenty of them are necessary in our daily life. Key technologies that drive the long run IoT is associated with smart sensor technologies together wireless detector the nanotechnology and miniaturization of the sensing device. It's planning to potential to watch the health conditions and thought IoTs of not solely human or animals

but collectively of assorted engineering structures. Right now it has reaches almost 50% of society, most of the internet users is increased day by day in our world.

Water Quality Monitoring System, Sensors: pH Sensor-Water Level Sensor-Temperature Sensor-Carbon Dioxide Sensor-Turbidity Sensor, Controller: FPGA, Communication Module: Zigbee [3]. Air Quality Monitoring System, Sensors: PMS5005 sensor-Humidity Sensor-Temperature Sensor, Controller: ARM, Communication Module: LPWA Transmitter Module and Power Module-USRP B210, Internet Protocol: TCP/IP Protocol [4]. Modern Healthcare System Using Body Sensor Network, Sensor: Blood Pressure (BP)-Electrocardiogram (ECG)-Electromyography (EMG)-Electroencephalography (EEG), Communication Module: 3G/CDMA/GPRS, Internet Protocol: Lightweight Anonymous Authentication Protocol [1]. IoT Based Healthcare System with Body Sensor Network, Sensor: Blood Pressure (BP)-Electrocardiogram (ECG)-Electromyography (EMG)-Electroencephalography (EEG), Controller: Raspberry PI 2, Communication Module: Local Processing Unit (LPU) [5]. Remote monitoring system of ECG and Body temperature signals, Sensors: ECG, Temperature sensor (LM35), Controller: Atmega328, Communication Module: Bluetooth [IEEE 802.15.1] [12]. Three Wireless sensor for environment monitoring, Sensor: BLE Sensors, Controller: PSoc3, Communication Module: Local area unit (LAN) [RN-131C/G], Internet Protocol: UDP-HTTP [13].

Real time Iot systems style needs totally different transducers (Sensors, actuators) to convert mechanical signal to electrical signal and electrical signal to mechanical. Sensors could also be active or passive sort, active sensor won't need extra power provide for conversion, however passive sensor need external provide for conversion. These entire passive sensors area unit classified as resistive and inductive and capacitive sort. These all sensor can convert physical parameters (pressure, speed force, weight, humidity and temperature) in to electrical parameters. The sensor can provide minute voltage with noise contamination, thus signal processing block can amplify the signal and removes the noise. Digitalization block can convert the analog signals to digital signal, so the controller will simply method he incoming information. The Data need to upload the cloud using wireless module through Internet protocols. Finally the entire modules area unit interfaced to a controller. This will control the operation based on the algorithm rule.

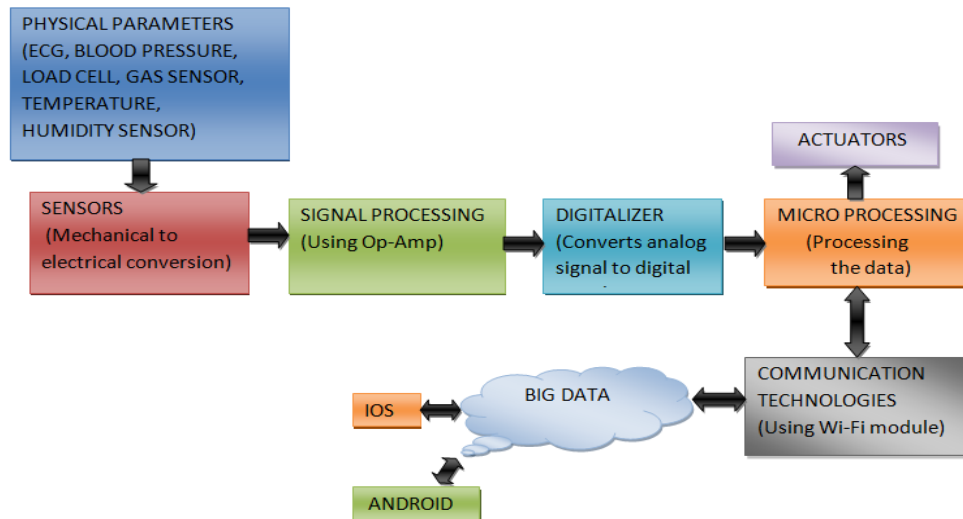

Figure 1: Basic block diagram for the monitor and controlling system

II. PROPOSED SYSTEM

In “Designed a Novel IoT Based Cardiovascular Patient Health and Surrounding Weather Monitoring and Controlling System”. Electrodes based ECG, Pulse detecting sensor, Strain gauge type Load sensor, Resistive type of Gas sensor, capacitive type of Humidity sensor, IC based Temperature sensor. These sensors are connected a

Microcontroller and send the data to wireless data Trans receiver module. This wireless data trans-receiver module will be sending the data to cloud continuously and update the values. It will show the monitoring of the climate changes observed for baby health and in our atmosphere.

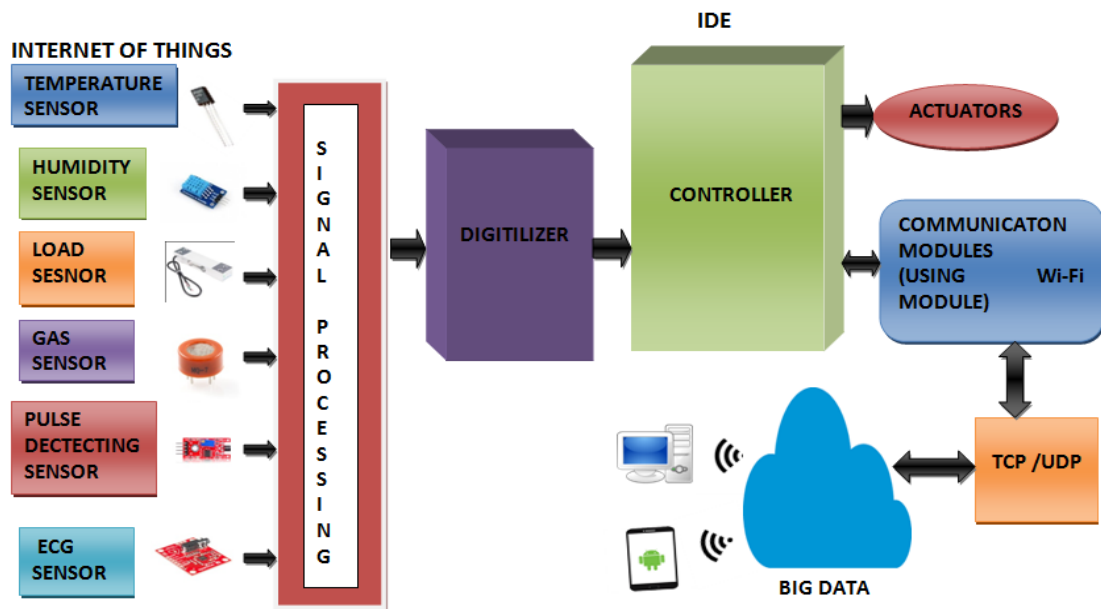

Figure 2: Block diagram of a baby health monitor system

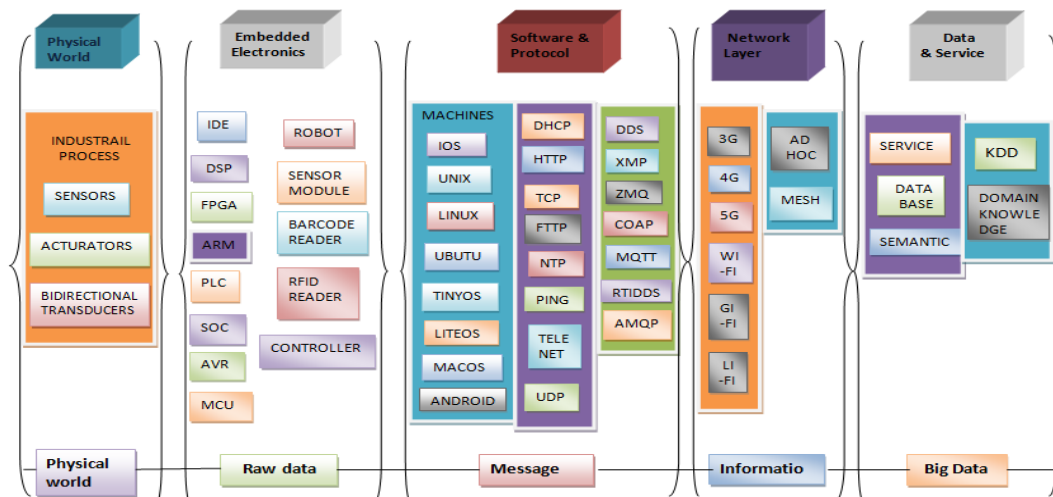

Figure 3: Available Technologies at different levels to design IoT System

### III. THEORETICAL ANALYSIS

#### A. Temperature Sensor:

Temperature sensing element could be a device it evaluates the warmth and coolness. It's accustomed to sense the temp range. Here we are using IC based temperature sensor that which gives temperature values accurately. Compare to thermocouples it provides a best results. Main aim of the IC based temperature sensor is to measure the temperature. It provides associate electrical output once there's a temperature changes. LM35 encompasses a multiplier factor (i.e. .01v/ov). It does not need any external trimming. Temperature sensing maintain on accuracy of +/- 0.4<sup>o</sup>c at room temperature and +/- 0.8<sup>o</sup>c over a variety of 0<sup>o</sup>c to +100<sup>o</sup>c. This Sensor element contributes a voltage output (i.e. linearly commensurate to Celsius temperature). Provide currents area unit < 0.5μA. This device extracts merely 60μA from the supply, it's a source current and its sinking capacity is bounded to 1μA. Operational temperature vary is -55<sup>o</sup>C to 150<sup>o</sup>C. The temperature device encompasses an output current is 10MA, Supply Voltage is -0.2(max) – 35V (max), Output voltage (-1(min) to 6V (max)). This sensor gives a analog output, and it's a temperature slope is 10mV/<sup>o</sup>C.

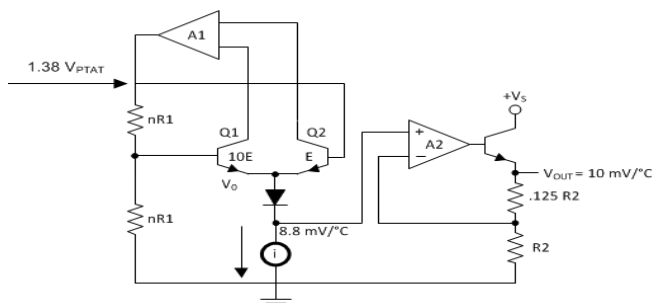

Figure 4 : Circuit Diagram for IC based Temperature Sensor

#### B. Humidity Sensor:

The capacitive type of humidity sensor is accustomed to sense the water levels in air. This model of resistive humidity be created of two parallel plates within the middle of that there's a dielectric substrate that which performed as an electrodes. The conductivity betwixt the electrodes was developing when the content of water vapor is being received by dielectric element. This dielectric material has mounted vary from 2 to 15. Ions which are delivered by dielectric substrate increase the conductivity betwixt 2 electrodes. Humidity sensor offers the digital outputs. It performs a quick reaction and also it provides an estimable quality. Humidity sensor is a little size, low power consumption. Measurement range of wetness detector is 20-90% or 0<sup>o</sup>C-50<sup>o</sup>C (relative humidity) [8]. It gives humidity accuracy is +/-5%RH and also it offers temperature accuracy is +/- 2<sup>o</sup>C. The mathematical expression for computation of capacitive type humidity was given as

$$C = (\epsilon_0 A) / d \tag{1}$$

Where, A is Area under conducting plates, d is the distance between the plates,  $\epsilon_0$  is the free space permittivity and is given as  $8.825 \times 10^{-12}$  f/m.

By using this expression we can determine the relative humidity that which can be representing in percentage

$$RH \text{ in } \% = \text{Absolute Power} / \text{Saturated Vapor} \tag{2}$$

#### C. Load Cell:

Load cell could be resistive kind electrical device accustomed for the explanation of measuring the weights. During this weight measuring cell contain the strain gauge principle of strain gauge is additional renowned. The strain gauge principle comfortably calculates the variable resistance load cell transducer. The functioning of load cell could be a metal conductor is compressed or extended the distortion of

the conductor is seems that outcome changes within the resistance. If this can appeared there's a modification in the length and diameter of the conductor as well as take place. Strain gauge is one among the foremost valuable sensing element it calculates the mechanical qualities. The strain gauge contains of tensile and compressive strain. The strain gauge is often accustomed selecting an enlargement at the side of contraction. The expression for the Load cell is given by:

$$\text{Load cell, } R = \rho l / A \quad (3)$$

Where  $\rho$  is the specific resistance of the material in  $\Omega$ ,  $l$  is the length of the conductor in meter and  $A$  is the area of the conductor in meter square.

#### D. Gas Sensor:

Gas sensor is the resistive type of electrical device. It was detects the amount of carbon mono oxide which present in the air .This detector co-gas concentration anywhere from 20-20000ppm.It gives a quick response. This gas detector is high sensitivity to carbon monoxide. Gas sensor is low cost and it has a protracted life. It absolutely was employed in several applications. Gas sensor gives the output is in analog resistance. Conditions for the gas sensor (for the quality take a look at circuit:  $V_c: 5.0v \pm 0.1v, V_H$  HIGH:  $5.0V \pm 0.1V, V_H$  LOW:  $1.5V \pm 0.1V$ ) expression for gas sensor:

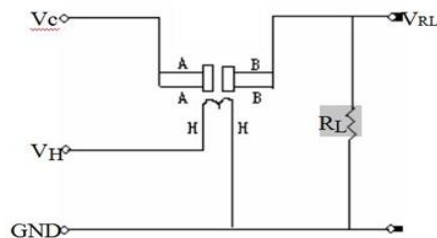

Figure 5 : Circuit diagram for Gas Sensor

$$P_s = V_c^2 * R_s / (R_s + R_L)^2 \quad (4)$$

$$R_s = (V_c / V_{RL} - 1) * R_L \quad (5)$$

Where  $P_s$  is the Power of Sensitivity body,  $R_s$  is the Surface resistance and  $R_L$  is the load resistance.

#### E. ECG:

The AD8232 is associate integrated signal learning block for ECG and alternative bipotential measure application. It is designed to extract, amplify and filter tiny biopotential signals with in the presence of clamorous condition such as those produce by motion or remote conductor placement [15]. This style permits for associate ultralow power analog to digital (ADC) or an embedded microcontroller to amass the signaling simply. Performance is such from  $0^{\circ}C$  to  $70^{\circ}C$ , and it is operational from  $-40^{\circ}C$  to  $+85^{\circ}C$ . ECG is one in all the foremost wide used sign sensing and health observation methodology and provides useful diagnostic data regarding the cardiovascular system.

#### F. Pulse Detecting Sensor:

The Heart beat sensor is intended to give simple yield of heart beat when a finger is set on it. At the point when the heart indicator begins working, the best most LED will begins blazing with each heart beat. The yield of this sensor can be associated with micro controller specifically to quantify the heart beat. It works on the standard of light adjustment by blood move through the nerves of the finger at each heartbeat. It gives analog outputs, and it is compact size. And it has a working voltage +5V DC.

#### G. TCP protocol:

For the wireless transmission and receiving of knowledge we tend to essentially use a pair of kinds of protocols. They're 1) TCP 2) UDP the TCP/IP protocol is a connection oriented once a connection is implemented, data will be transfers as either sides. Transmitting of message through internet from one pc to different pc is executable. TCP/IP protocol is employed in high reliableness conditions. This Protocol takes terribly less time for transmission. This sort of protocol provides warranty of information transfer for source to destination. TCP/IP Protocol offers reliable. These types of protocol have general header files (i.e. Checksum, Source Port, and Destination Port). Examples of TCP/IP Protocol: http, tftp, smtp, ftp, dns, https, and telnet. Normally we've such style of commands (i.e. Acknowledgement, Synchronization). TCP/IP Protocol have 2 properties. 1) error checking 2) error recovery. The header size of this protocol is 20bytes. Using TCP/IP permits the low power operation of the Wi-Fi sensors atributable to its connection oriented nature. More over this protocol supplies lower packet sizes. Increasing speed and low latency. In TCP IP layers now main 4 layers are used they are host to internet, internet later, application layer, and transport layer.

1) *Host-to-Internet:* From a system administration perspective, a host alludes to any PC that's interlinked with other machines through an online affiliation. Every host has its distinctive scientific discipline address; shaped by the PC's nearby number and the specific number of the system it has a place with. The Internet have for this situation is in charge of putting away information that will be transmitted to different machines, more often than not client's PCs, called remote terminals.

2) *Internet layer:* Internet-layer protocols use IP-based packets. The internet layer does not include the protocols that define communication between local (on-link) network nodes which fulfill the purpose of maintaining link states between the local nodes, such as the local network topology, and that usually use protocols that are based on the framing of packets specific to the link types. Such protocols belong to the link layer.

3) *Application layer:* An application layer is an abstraction layer that specifies the shared protocols and interface methods used by hosts in a communications network. The application layer abstraction is used in both of the standard models

of computer networking: the Internet Protocol Suite (TCP/IP) and the Open Systems Interconnection model.

4) *Transport layer:* In computer networking, the transport layer is a conceptual division of methods in the layered architecture of protocols in the network stack in the Internet Protocol Suite and the Open Systems Interconnection (OSI). The protocols of the layer provide host-to-host communication services for applications. It provides services such as connection-oriented data stream support, reliability, flow control, and multiplexing.

UDP/IP Protocol is a connectionless oriented protocol. By using UDP/IP Protocol more information can be transmitted in the form of packets in chunks. Data transmission is extremely high in UDP/IP Protocol. During this protocol there is no error checking process. Samples of UDP/IP Protocol are dns, tftp, rip. The header size of this protocol is 8 bytes.

#### H. Controller:

Controller has the ability to do the effort and that equivalent to one or more additional cores. Here we will mention that controller is small type of pc on a single (IC). In this project we used the controller is ATmega328p is delineate by ATMEL in Mega AVR family. Board can perform external supply of 6 to 20 volts. If applying more than 12v, the voltage regulator may be gets over heat and also injury the board. The re-recommended range is 7 to 12 volts. It is 8-bit controller and it is operates at frequency range is 16MHZ that has 32KB of flash memory for saving code and conjointly 2KB SRAM & 1KB of EEPROM. Controller has 13 digital input and output pins (i.e. 5 analog input and 6 an analog output pins (PWM only)). Controller has operational voltage is 5V. Each pin can offer (or) receive a most of 40mA on input and output pins.

#### I. Wi-Fi:

Wi-Fi provides the information rates-impractically up to 600 Mb/s for the oftentimes used 802.11 b/g/n model managed by Wi-Fi Connections. Various methods are accessible with various operating frequency's and thought puts. Right now mostly used current method is 802.11b/g/n. Which is suitable with advanced gadgets, although lesser speed. In market currently applicable version is 802.11ac, it's gives high speed, and conjointly helps older devices. The gap amendment on implementation, however it will carry up to 200m. Wi-Fi is general in house networking application. Wi-Fi is well carries with none needed of cable. It has a server and shopper modes[37]. P2P, Soft-AP these are the access point modes of Wi-Fi module. In ESP8266 the data packets are transfer in UDP and TCP Protocols. In this module interfacing between the microcontroller and peripheral devices area unit within the kind of Transistor-Transistor logic (TTL) Serial. During this module 5 concurrent sockets are used. The information is encrypted by using up to WPA2-PSK. Operating frequency is 2.4GHZ or 5GHZ. This wireless module is suits for IoT devices.

#### J. Cloud computing:

Cloud computing has appeared as a current technology which gives huge volume of computing and data storage capability. Its purpose is to defeat numerous issues appeared from the quick development of enterprises and therefore the development of their documents. Literally the accessible space for the preserver the data on own computer cannot meet the at this time desires.

At present, cloud domain is developing use of virtual technologies. The cloud has developed a set of advanced organizational structures for capacity, messaging, content, availability. Right now cloud has become as a portion of our daily routine. Most of them have a membership in cloud domain. Most of them also create the use of data exchanging processes like Microsoft and Google drive, SAP.

Here the information will be send to cloud through a TCP/IP protocol. The cloud is the combination of clusters and grids. Cloud allows designing, configuring, and customizing application Online. User can access database resource through internet from anywhere. It provide the four services (i.e. Public cloud, Private cloud, Community cloud, Hybrid cloud) public network means it is simply approachable to the general public and it have a less secure. Private cloud is accessible within organization and it has high security. Community cloud is accessible by a group of organization. Here hybrid cloud is the mixture of public and private cloud. In this hybrid cloud critical activities are performed.

Using private cloud and non critical activities are performed using public cloud. Cloud computing has three varieties of service models i.e. PAAS, IAAS, SAAS. These services are run the applications and then it stores the information in on-line.

PAAS ought to be providing the runtime environment for deployment tools and applications. Pass approves to escape the expense and complication of buying and handling software licenses.

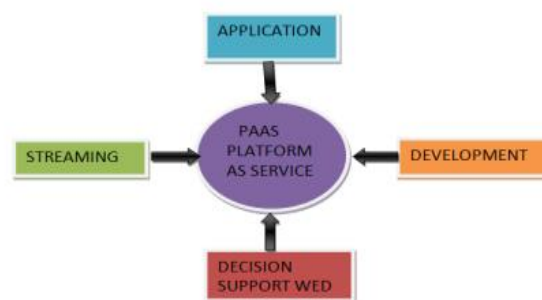

Figure 6 : Platform as a Service

SAAS permits users to associate to use cloud depended apps done with the internet. SAAS have some examples i.e. email and calendaring.

Table1. Comparison of different IoT systems with Present Proposed IoT System

| Parameter            | Cho Zin Myint (2017) Ref[3]                               | Kan Zheng (2016) Ref[4]        | Prosanta Gope (2015) Ref[1]                        | Kuo-Hui Yeh (2016) Ref[5]                  | J.P.Tello (2013) Ref[12]                               | George Mois (2017) Ref[13]                       | Proposed System   |
|----------------------|---|--------------------------------|--|--|--|--|---|
| Area                 | Water Quality Monitoring System                           | Air Quality monitoring System  | Modern Healthcare System Using Body Sensor Network | Healthcare System with Body Sensor Network | Monitoring system for ECG and Body Temperature Signals | Three Wireless Sensor For Environment Monitoring | Weather monitoring , Health monitoring System               |
| Sensors              | PH, Water level , temperature, Carbon dioxide, Turbidity. | PMS5005, Temperature, Humidity | BP, ECG, EMG, EEG.                                 | BP, ECG, EMG, EEG.                         | ECG, Temperature (LM35).                               | BLE Sensors                                      | ECG, Pulse Detector, Load cell, Gas, Humidity, Temperature. |
| Controller           | FPGA  | ARM                            | ---  | Raspberry PI2                              | Atmega328  | PSoc3  | Atmega328P  |
| Communication Module | Zigbee  | LPWA Transmitter Module        | Mobile (3G/CDMA/ GPRS)                             | Local Processing Unit (LPU)                | Bluetooth- IEEE802.15.1                                | Local area unit (LAN) [RN131C/G]                 | Wi-Fi Module (ESP8266)                                      |
| Internet Protocol    | ---   | TCP/ IP Protocol               | Lightweight Anonymous Authentication Protocol      | ---  | ---  | UDP,HTTP   | TCP/IP Protocol   |
| Cloud Computing      | ---   | ---                            | ---  | ---  | ---  | ---  | PAAS Technique  |

Table2. List of Sensor's used and Properties

| Sensors                | Materials                          | Mechanism                                      | Conversion ratio | Range                 | Outputs         | Linearity Behavior                   | Supply Range | Speed |
|------------------------|------------------------------------|--|------------------|-----------------------|-----------------|--------------------------------------|--------------|-------|
| Temperature Sensor     | ---                                | IC Based                                       | 10mV/°C          | 55°C to 150°C         | Analog Outputs  | Linear +10Mv/°C Non-Linear ± (1/4)°C | 4V - 30V     | 9600  |
| Humidity Sensor        | Polymer Resistor                   | Capacitive Based                               | ---              | 0°C to 50°C 20-90% RH | Digital Outputs | ---                                  | 3V - 5.5V    | 9600  |
| Gas Sensor             | Gas sensing Layer:SnO <sub>2</sub> | Resistive Based                                | ---              | 20-20000ppm           | Analog Outputs  | ---                                  | 5V           | 9600  |
| Load Cell              | Aluminum-alloy, Colorless anodized | Resistive Strain Gauge                         | 2.0±0.1mV/V      | 0 to 40kg             | Digital Outputs | Non-linearity < ± 0.03% of FSO       | 9 - 12V      | 9600  |
| ECG Sensor             | Electrodes                         | Human vibrations signals to electrical signals | ---              | ---                   | Analog Outputs  | ---                                  | 2.0 - 3.5V   | 9600  |
| Pulse Detecting Sensor | ---                                | UV Rays Based                                  | ---              | ---                   | Analog Outputs  | ---                                  | ---          | 9600  |

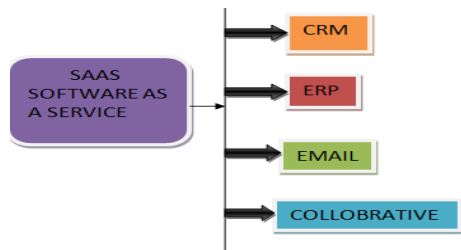

Figure 7 : Software as a Service

IAAS is a present computing organizational structure, provisioned and controlled done with the internet. It helps to prevent the expense and complication of buying and controlled our individual physical servers and another datacenter framework. And IAAS have fundamental resources (i.e. physical machines, virtual machines, virtual storage).

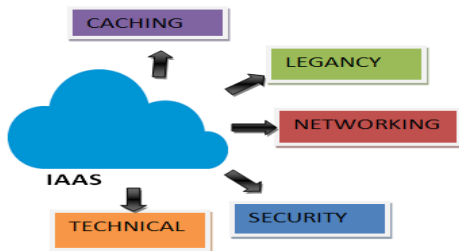

Figure 8 : Infrastructure as a service

IV. RESULTS

In this IoT system we have advanced six sensor's i.e. Pulse Detecting Sensor, Humidity Sensor, Gas Sensor, Temperature Sensor, Load Cell, Electrode based ECG Sensor. These are connected to the microcontroller. By this process we are getting these particular graphs.

Here the Pulse Detecting Sensor, Electrodes based ECG and Load Cell are used for how the baby condition is going on is under controller of Integrated Development Environment.

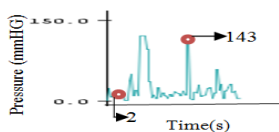

Figure 9: Pulse Detecting Sensor Data Local Monitoring

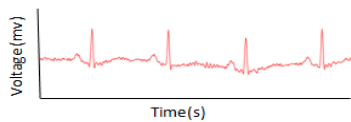

Figure 10: ECG Data Local Monitoring

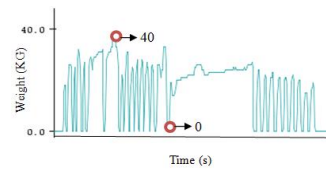

Figure 11: Load Cell Sensor Data Local Monitoring

Here Capacitive based Humidity Sensor, Resistive based Gas Sensor and IC based Temperature Sensor these Sensor are the used for Monitoring the baby surrounding weathers is under controller of Integrated Development Environment. Capacitive based Humidity Sensor range is (20-90%). In practically is done in project with the range of (0-74.02%).

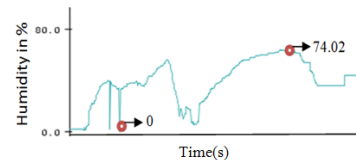

Figure 12: Humidity Sensor Data Local Monitoring

Resistive based Gas Sensor range is (20-20000ppm). In practically is done in project with the range of (0-1425ppm).

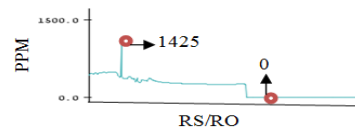

Figure 13: Gas Sensor Data Local Monitoring

IC based Temperature Sensor range is (-55°C - +150°C ). In practically is done in project with the range (0°C-300°C).

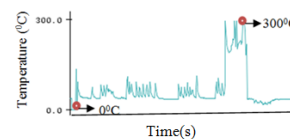

Figure 14: Temperature Sensor Data Local Monitoring

After getting the results from micro controller, then microcontroller is connected to Wi-Fi module. A Wi-Fi module is employed as a communication device to produce the internet to sensors and its operative frequency is 2.4GHz with IEEE 802.11b/g/n customary. The Wi-Fi module will transmit and receive the information with 115200 baud. This TCP IP layer used to establish the channel between the cloud and IoT system. In cloud we used a PAAS technique. By using this PAAS technique we upload the information in the cloud. These data can be accessible to the doctor who is at the far and the controlled conditions sent by them are received using the wireless devices which are using the TCP IP. An indication can also be given by the microcontroller if any values of any parameter changes beyond the threshold values. By this process we get these particular graphs.

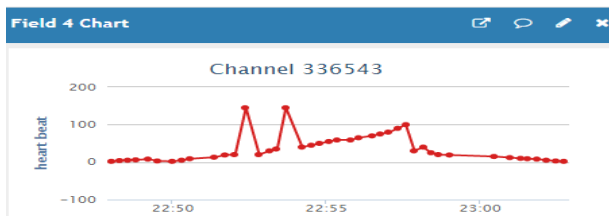

Figure 15: Pulse Rate Monitoring Sensor Data Uploaded in Cloud

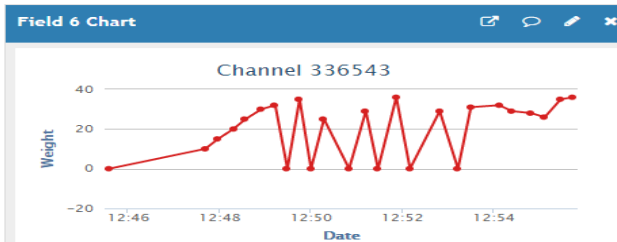

Figure 16: Load Cell Sensor Data Uploaded in Cloud

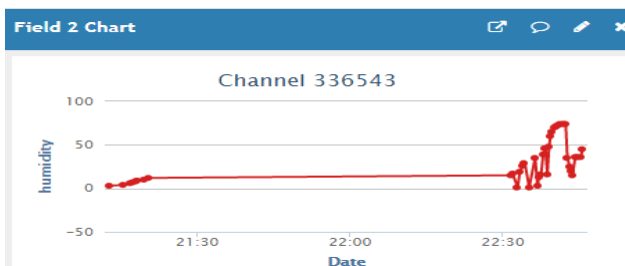

Figure 17: Humidity Sensor Data Uploaded in Cloud

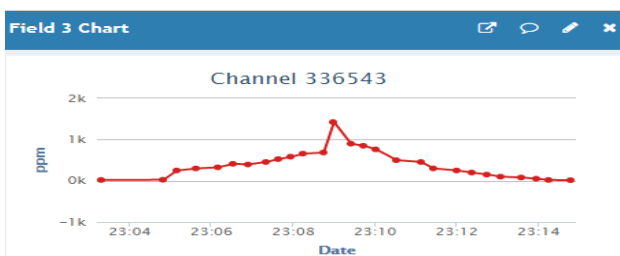

Figure 17: Gas Sensor Data Uploaded in Cloud

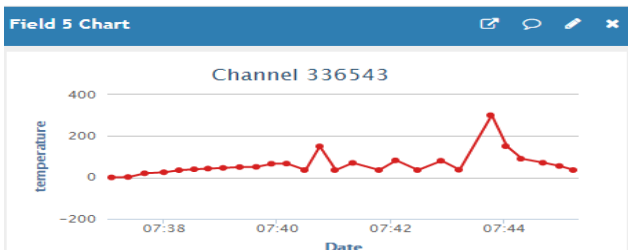

Figure 18: Temperature Sensor Data Uploaded in Cloud

## V. CONCLUSION

In this design we have provided an internet to six sensors using communication module which will help to upload the sensors data in to the cloud for the further processing. Sensors and communication modules are interface with the controller

with 16 MHz clock frequency. In this system overall 6 sensors are used i.e. UV ray's based pulse detecting sensor, Electrodes based ECG, Strain Gauge based Load Cell, IC based Temperature Sensor, Capacitive based Humidity Sensor, Resistive based Gas Sensor. Operating frequency is 2.4GHz of Wi-Fi module is used for the communication device to provide the internet to sensors. The Wi-Fi module can transmit and receive the data with 115200 baud rate. TCP protocol was establishing the channel between the IoT system and the database in the cloud. In cloud we store the information within the various fields. We have used a PAAS technique in the cloud. Here wireless data trans-receiver module will send the information to cloud constantly and refresh the qualities. It'll show the observance of the climate changes determine for baby health and in our atmosphere.

## REFERENCES

- [1] Prosanta Gope, Tzonelih Hwang, (2015), "BSN-Care: A Secure IoT-based Modern Healthcare System Using Body Sensor Network", 0.1109/JSEN.2015.2502401, Page No:1-9.
- [2] Basim Hafidh, Hussein Al Osman, Juan Artega-Falconi, Haiwei Dong, and Abdulmotaleb EL Saddik, (2016), "SITE: The Simple Internet of Things Enabler For Smart Homes", 10.1109/ACCESS.2017.2653079, Page No:1-15.
- [3] Cho Zin Myint, Lenin Gopal, and Yan Lin Aung, (2017), "Reconfigurable Smart Water Quality Monitoring System in IoT Environment", IEEE Computer Society, Page No:436-440.
- [4] Kan Zheng, Shaohang Zhao, Zhe Yang, Xiong Xiong, And Wei Xiang, (2016), "Design and Implementation of LPWA-Based Air Quality Monitoring System", 10.1109/ACCESS.2016.2582153, Page No:3238-3245 .
- [5] Kuo-Hui Yeh, (2016), "A Secure IoT-based Healthcare System with Body Sensor Networks", 10.1109/ACCESS.2016.2638038, Page No:1-12.
- [6] Ainhoa Gaston, Ibon Lozano, Fátima Perez, Fernand Auza, and Joaquín Sevilla, (2003), "Evanescent Wave Optical-Fiber Sensing(Temperature, Relativ Humidity,and pH Sensors)", VOL. 24, NO. 3,Page No:806-811.
- [7] Adriana M. Adami, Misha Pavel, Tamara L. Hayes and Clifford M. Singer, (2010), "Detection of Movement in Bed Using Unobtrusive Load Cell Sensors", VOL. 14, NO. 2, Page No:481-490..
- [8] Ainhoa Gaston, Ibon Lozano, Fátima Perez, Fernand Auza, and Joaquín Sevilla, (2003), "Evanescent Wave Optical-Fiber Sensing(Temperature, Relativ Humidity,and pH Sensors)", VOL. 24, NO. 3,Page No:806-811.
- [9] Seoung-Bum Lee, Gahng-Seop Ahn, and Andrew T. Campbell, Columbia University, (2001), "Improving UDP and TCP Performance in Mobile Ad Hoc Networks with INSIGNIA", Page No:156-165.
- [10] Justin Riley, John Noss, Wes Dillingham, and James Cuff, Harvard University Ignacio M. Llorente, OpenNebula,(2017), "A High-Availability Cloud for Research Computing", Page No:92-97.
- [11] Jun Zhou, Zhenfu Cao, Xiaolei Dong, and Athanasios V. Vasilakos,(2017), "Security and Privacy for Cloud-BasedIoT:Challenges, Countermeasures, and Future Directions", 10.1109/MCOM.2017.1600363CM, Page
- [12] J.P.Tello, O.Manjarrés, M.Quijano, A.Blanco, F.Varona and M.Manrique, (2013), "Remote Monitoring System of ECG and Body Temperature Signals", VOL. 11, NO. 1, Page No: 314-318.



- [13] George Mois, Silviu Folea, and Teodora Sanislav, (2017), “Analysis of Three IoT-Based Wireless Sensors for Environmental Monitoring”, Page No:1-9.
- [14] Ebrahim Nemati, M. Jamal Deen, and Tapas Mondal,(2012), “ A Wireless Wearable ECG Sensor forLong-Term Applications”, Page No:36-43.