

# Electro-Resales

---

## Getting started with the Time Domain Reflectometer

### Background

The Time Domain Reflectometer (Hereafter called a TDR) is designed to be used with an oscilloscope to allow simple measurements to be conducted on coaxial cables. Such measurements include, but are not limited to, determination of cable length and determination of the location of a break or short in the cable. The TDR does this by using a high speed clock pulse that is transmitted down the cable, this pulse is then reflected by the un-terminated cable leading to a second signal being available on the 'scope screen. Using cursors or counting screen divisions will allow the difference between the original pulse and reflected pulse time to be determined.

Using this time and some simple math will allow cable length or the position of a break to be determined. By following the steps in this guide you will be able to quickly utilize the TDR for your own needs.

### Initial Setup

The TDR requires a DC power supply terminated in a 2.1 x 5.5 mm barrel jack, center positive. The voltage required can be from 9 VDC to 15 VDC, either from a power supply or a 9 Volt battery. The TDR has a 5 volt regulator on the PCB and is also reverse polarity protected.

Before connecting any power to the TDR first connect the unit to your oscilloscope using the Male BNC jack marked 'Scope' on the PCB, as per the images below;

Scope jack on TDR;



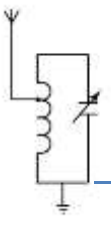

# Electro-Resales

Close-Up of the board connected to CH. 1 of a DSO



When the TDR is connected apply DC power, the LED should light, indicating the board is powered up. Once this is achieved, adjust your scope controls to display a square wave, exact settings will depend on your particular scope, however, aim to achieve the display shown in the next picture.



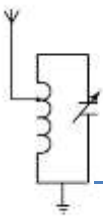

# Electro-Resales

After getting the square wave set correctly, now increase the timebase to stretch the square wave out so that you can see the leading edge of the pulse 'ringing', as in this next image.



At this point the TDR is ready to do some measuring.

## Determination of Cable length

Before attempting to measure long runs of cable or start determining if a cable is problematic, its best to start with a short cable (around 6-10 Foot), that is known to be good. Any coax cable type of impedance 50-75 Ohm can be used.

With the TDR set up and running as per the initial setup section, attach the test cable to the 'Test' BNC jack on the TDR PCB. DO NOT TERMINATE THE FREE END OF THE CABLE.

After connecting the cable the display on the scope will change to show a double pulse, the initial 'Ring' pulse and a second 'Ring' pulse that is the reflection of the first pulse coming back up the cable. The scope should display a signal similar to the next image.

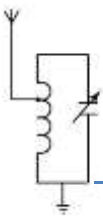

# Electro-Resales



This image shows the original and reflected pulse on the scope screen, also as the scope used for these measurements had an auto measure option, the delay in ns is also displayed, your scope may not have this feature or may use user selected cursors to measure time or voltage. If no measuring method is available the time delay can be determined by counting the divisions or parts of divisions, between the two pulses.

In the example above the delay is 9.98 ns.

## Some simple math - Honest!

To determine the cable length, we will need to know a little about how signals propagate or move in free space as well as the cable velocity factor.

For our purposes, in free space, signal propagation is 11.8"/ns, in a coax cable this is affected or changed by the velocity factor. For our purposes we can generally take Velocity Factor or VF as 0.66

Applying this VF to our Free Space figure means:

Propagation in a cable is  $11.8 \times 0.66$  (or 66% of 11.8) = 7.788"/ns

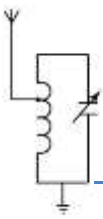

# Electro-Resales

To determine the cable length from the above we multiply the Propagation speed in the cable by the reflection time;

$$7.788 \times 9.98 = 77.724$$

This figure has to then be divided by 2 as the signal has travelled once down the cable and then back up for a second journey;

$$7.788 \times 9.98 / 2 = 38.86'' \text{ or approx. } 3.2' \text{ of cable length } (38.86/12)$$

## Assumptions

1. This calculation will give you the overall length of cable, however, we must remember that the TDR pcb introduces a little extra length, as BNC to BNC + the PCB is about 1.5 inches, plus the internal wiring of the scope may also introduce a little extra cable length.
2. For most cables the VF can be assumed at 0.66 (a typical figure)
3. All other cable conditions are ideal.

In the next example a longer cable is under test, as shown by the much longer delay:



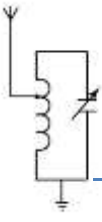

# Electro-Resales

---

Using the same math as before;

$$7.788 \times 20.35/2 = 79.24'' \text{ or a } 6.6' \text{ long cable}$$

In fact, this was a 9 foot long cable, with a break in the inner conductor at the 6.6' point. This starts to show how useful the TDR can be in situations where a break or issue with a cable is suspected, not only can the cable be confirmed as problematic, it can also show where the issue is.

## Other Uses

1. The examples given above have been for coaxial cables of typical impedance around 50 or 75 ohms. The TDR can also be used to test twisted pair cables by making a suitable connection of one pair and testing as previously described. Pairs can be tested in a multi bundle cable. The VF of twisted pairs is typically also 0.66.
2. Cable attenuation can be assessed by comparing the amplitude of the sent pulse to the amplitude of the return pulse. This can be very useful when dealing with suspect cables that have not shown a break in the conductor. A slight attenuation is to be expected in all cases – however, a severe attenuation in the return signal would warrant closer inspection.
3. Determination of mechanical issues. Cables in the field may be subject to sharp turns or tight cable wrapping/tie that can lead to dielectric breakdown and other mechanical or physical issues. Cables in good physical condition will display smooth rise and baseline on the scope. A damaged cable will show 'jittering' on the rise or a bumpy baseline that is indicative of mechanical issues.

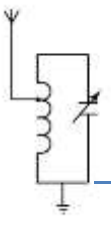

# Electro-Resales

## Notes

1. The TDR as supplied is capable of testing cables of 750-1000 Foot length
2. Velocity factors
  - a. Typical Coax such as RG8/RG58 – 0.66
  - b. Ladder line - 0.95
  - c. Foam Dielectric coax – 0.82
  - d. Twisted Pair – 0.66
3. Schematic:

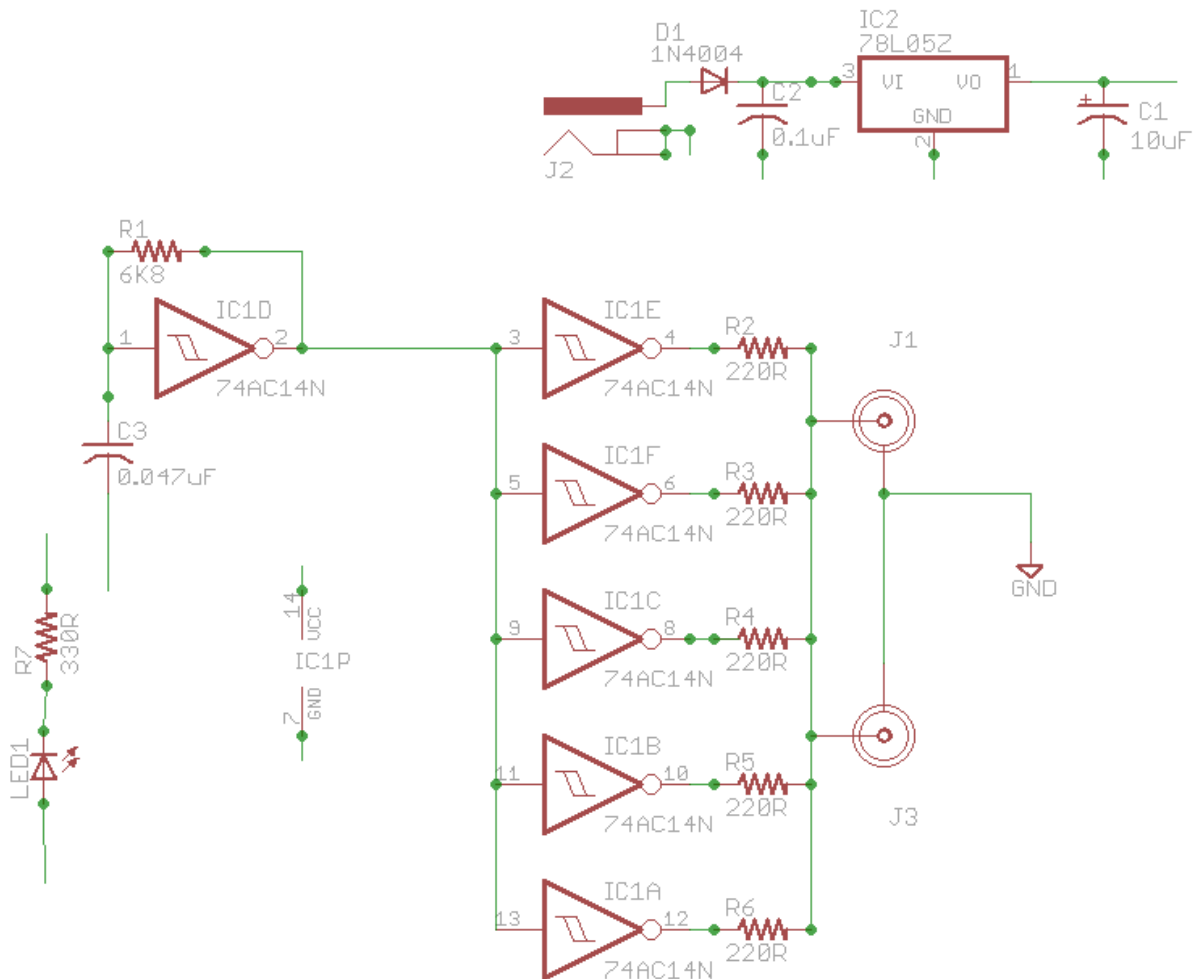

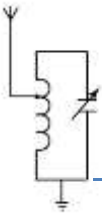

# Electro-Resales

---

## **LIABILITY DISCLAIMER**

**A person who constructs or works on electronic equipment may be exposed to hazards, including physical injury, the risk of electric shock or electrocution.. These hazards can result in health problems, injury, or death. Only qualified persons who understand and are willing to bear these risks themselves should attempt the construction of electronic equipment. By purchasing this item, the buyer acknowledges these risks.**

**There is a risk of electric shock, electrocution, burns, or fires that is inherent in the construction and use of electronic equipment. By purchasing this item, the buyer acknowledges these risks.**

**IN NO EVENT SHALL THE SELLER BE LIABLE FOR ANY SPECIAL, INCIDENTAL OR CONSEQUENTIAL DAMAGES OF ANY NATURE including, but not limited to, property damage, personal injury, death or legal expenses. Buyer's recovery from Seller for any claim shall not exceed the purchase price paid by Buyer for the goods, irrespective of the nature of the claim, whether in warrant, contract or otherwise. By purchasing this item, BUYER AGREES TO INDEMNIFY, DEFEND AND HOLD SELLER HARMLESS FROM ANY CLAIMS BROUGHT BY ANY PARTY REGARDING ITEMS SUPPLIED BY SELLER AND INCORPORATED INTO THE BUYER'S PRODUCT.**