

Comparison of FFT and Goertzel Algorithms Used in DTMF Detection System Using GUI

Pediredla Hima Bindu¹, Sateesh Virothu², Dr.M.Satya Anuradha³
¹M.Tech Student, ² Research Scholar, ³ Associate Professor
 Department of Electronic and Communication Engineering,
 Andhra University, Visakhapatnam, India
 (E-mail: pediredlahimabindu@gmail.com)

Abstract— Dual Tone Multi Frequency (DTMF) signalling system is now-a-days a prevalent part of Industrial automation and many other communication systems. In DTMF system, a dial tone composed of two sine waves is generated at transmitter end. At the receiver, the detection of DTMF signal can be achieved using different methods viz. digital filters, Fast Fourier Transform algorithm, Goertzel algorithm, correlation algorithm etc. In this paper, FFT and Goertzel algorithms are used for detection of DTMF signal and these algorithms are compared under different SNR conditions. The entire system is implemented in MATLAB Graphical User Interface (GUI). Additive White Gaussian Noise is added. The parameters of analysis considered for this work are Twist and computational complexity.

Keywords— DTMF; FFT; Goertzel algorithm; MATLAB, AWGN; snr; Twist

I. INTRODUCTION

In today's digital world, various methods are being developed to control devices wirelessly. Mobile phone is being used everywhere from household applications to industrial and military applications to operate devices from remote areas. Dual Tone Multi Frequency (DTMF) system has become an economic solution for this purpose.

DTMF signaling was developed by Bell labs in United States in 1960s in order to achieve the purpose of long distance telephone calling. It is also being used in communication systems, Automation systems. It was an ideal replacement for slower pulse dialing system where it was necessary to use rotary type dials which are quite slow.

Tone dialing is used in DTMF systems instead of pulse dialing. Tone dialing uses specific tones to indicate the number that was entered while pulse dialing uses a number of signal pulses. This tone dialing is very quick and easy to use method for long distance communication using telephone lines.

Dual tone multi frequency signaling system or touch tone system uses a signal composed of two specific frequencies when a tone is dialed in the touch tone keypad. The touch tone keypad consists of digits from 0 -9, alphabets A, B, C, D and symbols * and #. Each of these keys can be used to achieve a specific

function when used with a microcontroller for automation of systems.

At the transmitter of the DTMF system, a composite signal is generated with two tones when a key is pressed on touch tone keypad and is transmitted. This signal is detected at the DTMF receiver using different analog and digital detection methods. In analog methods, analog filters are used to detect signal. In digital methods, Digital filters, FFT algorithm, Goertzel algorithm, Correlation algorithm are used. Earlier analog methods were used. But due to the rapid development in digital communication, these methods are replaced by efficient Digital methods.

EARLIER WORKS

A. A. Deosthali et.al. [1] proposed the DTMF system which is developed by using second order Finite Impulse response adaptive notch filters to eliminate unwanted noise. They have used a sophisticated Decision Logic system to validate the detected signal. The system is studied under different SNR values. DTMF detection using Goertzel algorithm using MATLAB is implemented by Miloš Trajković [2]. It introduced the parameter tests like Twist test, SNR test and N test to test the system performance.

Suvad Selman[3] presented a DTMF system using various detection algorithms viz. Filter design approach, FFT algorithm, Goertzel algorithm and Sub-Band NDFT algorithm are used to develop the DTMF Detectors in MATLAB and this system is implemented using TMS320C6713, digital signal processor. The performance is compared using the parameters Figure of Merit and computational complexity.

Yongbao Song [4] had achieved the DTMF detection using the algorithms-FFT, Goertzel algorithm and SB-NDFT algorithm. The three algorithms are analysed and their advantages and disadvantages were given for comparison. Liu Yuying [5] gave a detailed analysis of the Goertzel algorithm filter banks and developed the DTMF system using Goertzel detection algorithm in the MATLAB environment.

In this paper, the implementation of DTMF system using two detection algorithms i.e., FFT algorithm and Goertzel algorithm. Further, a comparison analysis is given for these detection algorithms.

The paper is structured as: section 2 gives DTMF transmission and reception, section 3 gives Detection algorithms

section 4 gives flowcharts and description, section 5 gives results discussion followed by conclusion and references.

II. DTMF TRANSMISSION AND RECEPTION

A. DTMF Transmission

DTMF Transmitter system produces the dual tone signal by selecting frequencies from a set of eight audible frequencies. These frequencies are selected by AT&T and BELL Labs. This set of frequencies is transmitted in pairs to represent 16 signals, that represent digits 0-9, the letters A- D, and the symbols * and # in Touch tone keypad as shown in figure (1).

These frequencies are selected in such a way that they have the following unique properties:

(i)When a key is pressed then it can be detected by human ear since all tones are in audio frequency range. (ii)No frequency is harmonic to other frequency. (iii)Difference or sum of any two frequencies is not equal to any other frequency.

The frequencies used are divided into row and column groups depending on low and high frequencies respectively as shown in figure (1).

The DTMF signal generated for a tone can be represented as in equation (1).

$$x_{tr}(t) = A_0 \sin(2\pi f_1 t) + A_1 \sin(2\pi f_2 t) \quad (1)$$

Where A_0 =amplitude of low frequency sine signal

A_1 = amplitude of high frequency sine signal

f_1 = signal from low frequency group

f_2 = signal from high frequency group

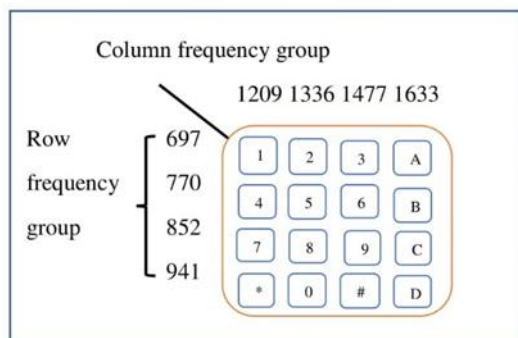

Figure 1: Touch tone Keypad

The generated signal is transmitted to the DTMF receiver which is at remote distance and the corresponding key is detected using various detection algorithms.

B. DTMF Reception

At the receiver, the signal received might be the original transmitted signal or the signal with noise added to it. In practical systems, the signal gets corrupted with noise in the channel before reaching the receiver. Thus in our system, an Additive White Gaussian Noise (AWGN) is added to the received signal to validate the key under noisy conditions to replicate the practical systems.

Some of the detection methods that are used are FFT algorithm, Goertzel algorithm, Correlation algorithm, SB-NDFT algorithm etc. In this work, FFT and Goertzel algorithms are implemented and their performance is compared using the parameters - Twist, power and Computational complexity.

III. DETECTION ALGORITHMS

The detection algorithms that are used in this work are given as follows.

A. Fast Fourier Transform Algorithm

Fast Fourier Transform is basically a faster way of computing Discrete Fourier Transform of a signal in digital signal processing. It is also the efficient way to calculate an N-point DFT if the number of samples is chosen to be a power of 2.

In FFT algorithm, a discrete signal is represented as an algebraic sum of its frequency components. The general representation of FFT of a discrete signal $\check{y}[n]$ is given in equation (2).

$$\begin{aligned} FFT \{ \check{y}[n] \} &= \check{Y}(K) \\ &= \sum_{n=0}^{N-1} \check{y}(n) e^{-j \frac{2\pi}{N} nk}, 0 \leq k \leq N-1 \end{aligned} \quad (2)$$

The continuous signal that is received at the DTMF detector be represented as $x_r(t)$ and this is signal is sampled and is represented as $x_r[n]$ and these are given in equations (3) and (4) respectively.

$$x_r(t) = B_0 \sin(2\pi f_1 t) + B_1 \sin(2\pi f_2 t) \quad (3)$$

$$x_r[n] = B_0 \sin\left(2\pi f_1 \left(\frac{n}{F_s}\right)\right) + B_1 \sin\left(2\pi f_2 \left(\frac{n}{F_s}\right)\right) \quad (4)$$

Where B_0, B_1 = amplitudes of the two sine signals

f_1, f_2 = frequencies of the two sine waves

F_s = sampling frequency

Now, FFT for the signal $x_r[n]$ is given in equation (5) as follows

$$X_r(k) = \sum_{n=0}^{N-1} x_r(n) e^{-j \frac{2\pi}{N} nk}, 0 \leq k \leq N-1 \quad (5)$$

$$= \sum_{n=0}^{N-1} x_r(n) W_N^{-kn}, 0 \leq k \leq N-1 \quad (6)$$

Where N=Number of samples

$$\text{and } W_N = e^{-j \frac{2\pi}{N}}$$

For DFT with N number of samples, number of complex additions required are N (N-1) and number of complex multiplications required are N^2 . But by using FFT algorithm, the

computations are reduced to about $N \log_2 N$ complex additions and $\frac{N}{2} \log_2 N$ complex multiplications. The reduction in computations is achieved by using the properties of the complex number W_N^{kn} . The properties that are used are symmetricity and periodicity.

For a DTMF signal only a specific set of frequencies are to be studied, but FFT algorithm analyses the entire spectral components which leads to power wastage and increase in computational complexity. Thus more efficient algorithm is introduced i.e., Goertzel algorithm.

B. Goertzel Algorithm

Goertzel algorithm analyses the spectrum only at the specific frequency/set of frequencies thus is more suitable for systems like DTMF. The computational efficiency depends upon the number of samples considered for the system analysis.

For the time-domain sequence $x_r[n]$, N-point DFT is $X_r(k)$, and we know that $W_N - k_N = 1$, so,

$$X_r(k) = DFT\{x_r[n]\} = \sum_{n=0}^{N-1} x_r[n] W_N^{nk} \quad (7)$$

$$= W_N^{-kN} \sum_{n=0}^{N-1} x_r[n] W_N^{nk} \quad (8)$$

$$= \sum_{n=0}^{N-1} x_r[n] W_N^{-(N-n)k} \quad (9)$$

Now consider a new sequence $y_r(n)$ as defined in equation (10)

$$y_r(n) = \sum_{m=0}^{N-1} x_r[m] W_N^{-(n-m)k} \quad (10)$$

$$= x_r[n] * W_N^{-nk} \quad (11)$$

Consider

$$\check{h}_k(n) = W_N^{-nk} \quad (12)$$

Thus,

$$X_r(k) = y_r(n)|_{n=N} = x_r[n] * \check{h}_k(n)|_{n=N},$$

$$k = 0, 1 \dots N - 1 \quad (13)$$

The equation for $X_r(k)$ in (13) indicates that DFT $X_r(k)$ is obtained as the Nth output value when discrete signal $x_r[n]$ is filtered by filter $\check{h}_k(n)$. Thus N-point DFT of $x_r[n]$ is changed to Nth output obtained by N filters. This is called as Goertzel algorithm.

The filter bank for Goertzel algorithm is as shown in figure 2.

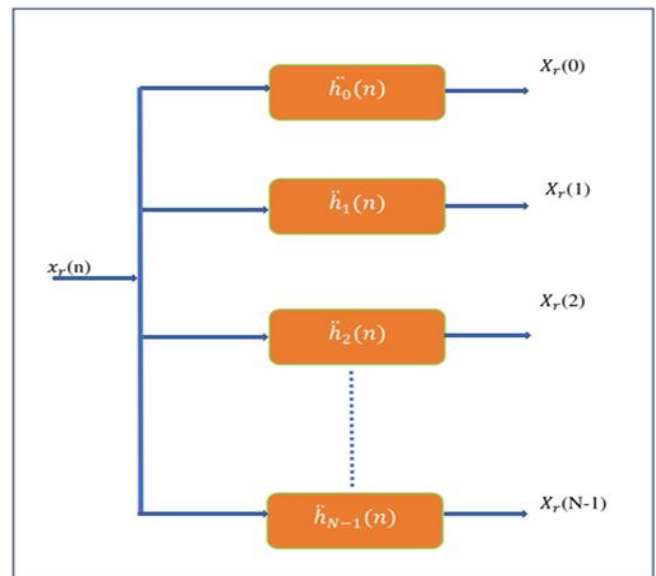

Figure 2: Goertzel Filter bank

The transfer function for the Goertzel filter is given in equation (14)

$$\check{H}_k(Z) = ZT\{\check{h}_k(n)\} = \frac{1}{(1 - e^{-j2\pi nk/N} z^{-1})} \quad (14)$$

To reduce the complex calculations, the first order single pole filter is changed into a second order double pole filter as given in equation (15). It is shown in figure3.

$$X_r = \frac{1 - e^{-j2\pi nk/N} z^{-1}}{1 - 2 \cos(\frac{2\pi k}{N}) z^{-1} + z^{-2}} \quad (15)$$

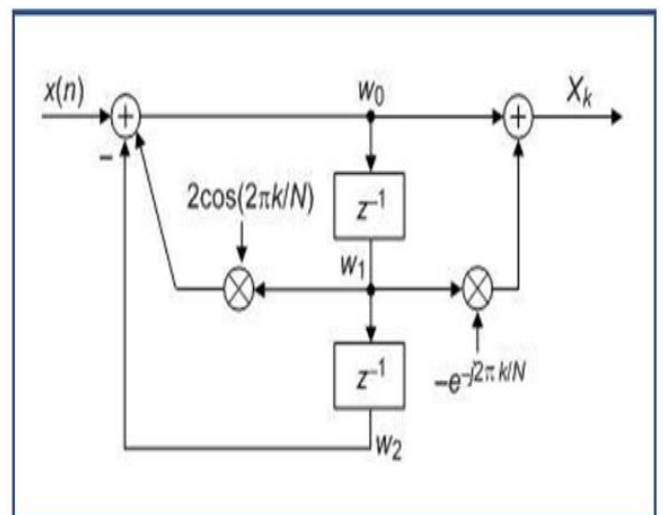

Figure 3: Modified Goertzel algorithm filter structure

IV. FLOW CHARTS AND PARAMETERS

A. Flow charts

The flowcharts for DTMF Transmission and Reception are given in figures 3 and 4.

Flow chart for DTMF transmission:

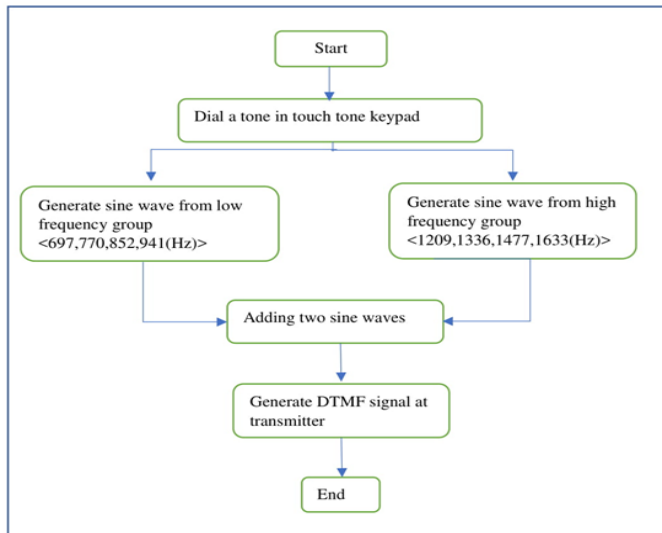

Figure 4: Flow chart for DTMF Transmission

Flow chart for DTMF reception:

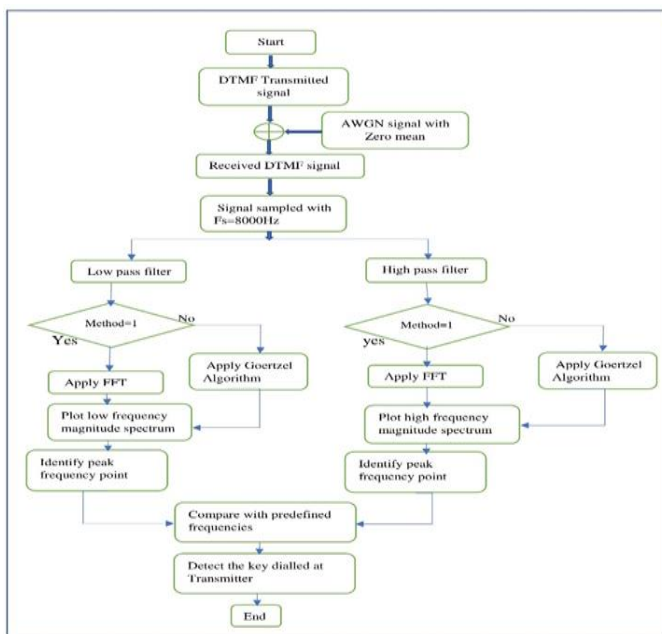

Figure 5: Flow chart for DTMF reception

B. Parameters

The International Telecommunications Union (ITU) specifications for the DTMF System are as follows:

a) Frequencies for a valid DTMF signal:

Row group (Hz): 697, 770, 852, 941

Column group (Hz): 1209, 1336, 1477, 1633

b) Frequency tolerances:

a. Maximum accepted frequency offset is 1.5%

b. Minimum rejected frequency offset is 3.5%

c) Signal duration:

a. Minimum value of acceptance for tone duration is 23mSec

b. Maximum value of rejection for tone duration is 40 mSec

c. Minimum value of pause time between two tones is 40mSec

d. Within a tone, 10 mSec is the allowable interrupt time

d) Twist (Difference between amplitudes (in decibels) of two frequencies):

a. Difference between low and high frequency is 8 dB when low frequency signal is at high power level (normal twist).

b. Difference between high and low frequency is 4 dB when high frequency signal is at higher power level (reverse twist).

e) Signal to Noise Ratio:

The detector should operate with SNR at 15dB or higher.

V. RESULTS

The parameters considered for DTMF system are

1. Time duration=50mS
2. Sampling frequency=8000Hz
3. Sampling time=0.125mS
4. Number of samples=205

The performance of DTMF system is observed in two cases as given below.

A. Original signal (without AWGN)

In the figures 6, 7, 8 and 9, Left hand side represents the Transmitter section and Right hand side represents the Receiver section.

Key pressed is '1' and corresponding row and column frequencies are 'f_r=697Hz' and 'f_c= 1209Hz'.

In Figure 6, Transmitter section: (a) keypad (b) Transmitted signal. Receiver section: (c) FFT low pass (d) FFT high pass (e) Received signal spectrum with FFT algorithm (f) Received signal in time.

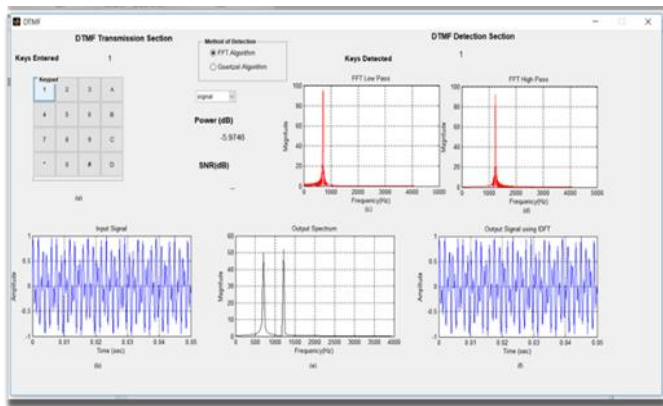

Figure 6: Signal detection (without noise) using FFT algorithm

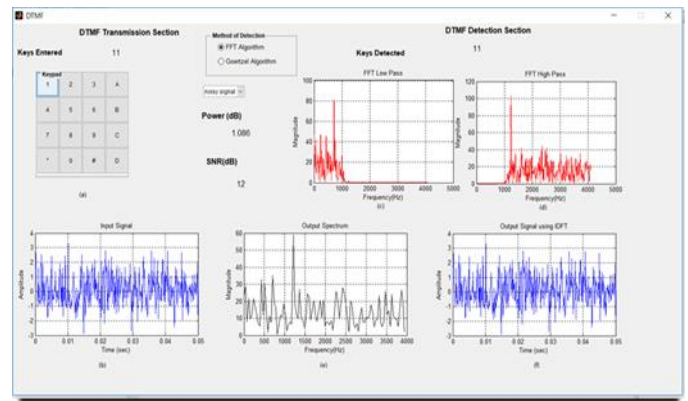

Figure 8: Signal detection (with SNR=12dB) using FFT algorithm

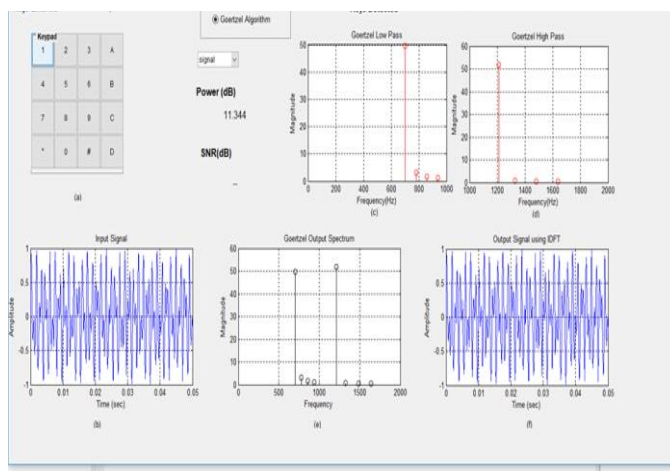

Figure 7: Signal detection (without noise) using Goertzel algorithm

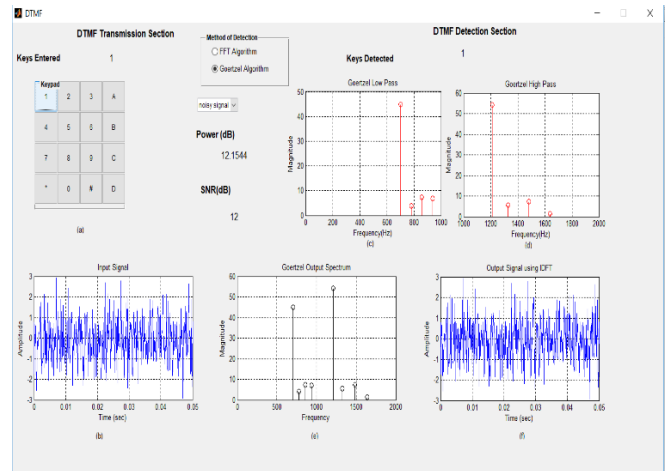

Figure 9: Signal detection (with SNR=12dB) using Goertzel algorithm

In Figure 7, Transmitter section: (a) keypad (b) Transmitted signal. Receiver section: (c) Goertzel low pass signal (d) Goertzel high pass signal (e) Received signal spectrum with Goertzel algorithm (f) Received signal in time.

B. Noisy Signal with SNR=12dB

Key pressed is '1' and corresponding row and column frequencies are 'f₁=697Hz' and 'f_h= 1209Hz'.

In Figure 8, Transmitter section: (a) keypad (b) Transmitted noisy signal with SNR=12dB. Receiver section: (c) FFT low pass (d) FFT high pass (e) Received signal spectrum with FFT algorithm (f) Received signal in time.

In Figure 9, Transmitter section: (a) keypad (b) Transmitted noisy signal with SNR=12dB. Receiver section: (c) Goertzel low pass signal (d) Goertzel high pass signal (e) Received signal spectrum with Goertzel algorithm (f) Received signal in time.

From figure 8 and 9, it can be seen that the peaks in FFT spectrum has changed when noise is added but the peaks in Goertzel spectrum are not changing even when noise is added to the transmitted signal and the dialed tone is being detected properly.

Table –I gives the graphical representation of DTMF system signals in both time domain and frequency domain at Transmitter section. Table –II presents the detected signals of DTMF system in both time and frequency domains using FFT and Goertzel algorithms.

TABLE I. SIGNAL WAVEFORMS AT TRANSMITTER SECTION WITH 12 DECIBELS SNR

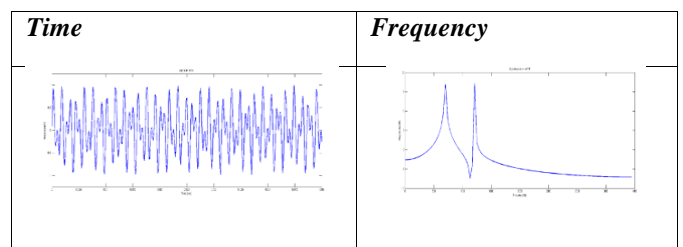
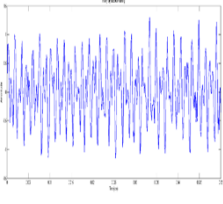
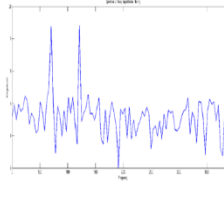
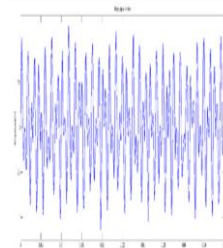
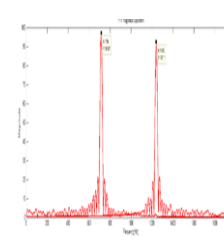
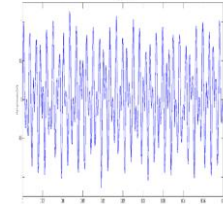
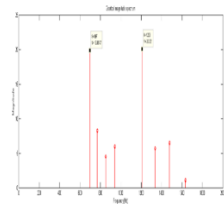

TABLE II. SIGNAL WAVEFORMS AT RECEIVER SECTION WITH 12 DECIBELS SNR

	Time	Frequency
Received signal before Filtering		
FFT Output		
Goertzel Output		

From Table-I and Table-II it can be noted that the system is less affected by noise in Goertzel algorithm than in FFT algorithm thus improving the level of detection and reducing the errors.

The DTMF system is tested under different SNR conditions for all the keys i.e., digits 0-9, alphabets A-D, symbols # and *. Of all the tones, two keys are selected randomly and the results for those tones are being presented in this work.

The following parameters are measured for the DTMF system with the two detection algorithms at SNR=15dB when the key # is transmitted from the DTMF transmitter section

TABLE III. TABLE OF PARAMETERS

Parameter	FFT Algorithm	Goertzel Algorithm
Run time(Sec)	0.59	0.38
Twist(dB)	0.57	0.39

From the table, it is observed that Goertzel algorithm takes less time, and provides low twist than FFT algorithm. (The computational complexity is a calculated mathematically and so

run time is measured for the comparison.) Thus it can be inferred that Goertzel algorithm is more efficient than FFT algorithm.

TWIST VS SNR:

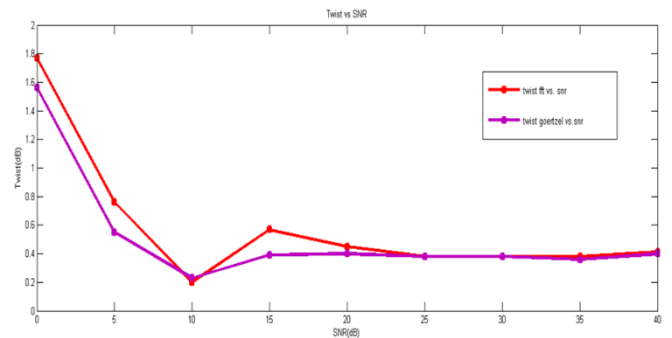

Figure 10: Twist vs SNR plot

Twist is defined as the power difference (in dB) between two frequencies used for the DTMF signal.

Figure 10 shows the change in twist occurred for the corresponding change in SNR value. From the graph, it is observed that Goertzel algorithm produces low twist at higher noise levels when compared with FFT algorithm.

CONCLUSION

In today’s digital era, DTMF plays a prominent role in Industrial automation, Automatic robotic control systems and many other areas. In this paper, DTMF system is implemented and the system performance is analysed under different noisy conditions. The main purpose of this work is to give a comparison analysis of FFT and Goertzel algorithms to improve system performance. From the results, it can be inferred that Goertzel algorithm requires lesser time because of low computational complexity, and provides lower twist under noisy conditions than that of FFT algorithm. Thus it can be inferred that Goertzel algorithm is more efficient than FFT algorithm. In future course of work, the system performance can further be improved by using other algorithms such as sub-band Non Discrete Fourier Transform (NDFT) algorithm, correlation algorithm.

REFERENCES

- [1] A. A. Deosthali, S. R. McCaslin, and B. L. Evans, “A Low-Complexity ITU-Complaint Dual Tone Multiple Frequency Detector”, IEEE Transactions on Signal Processing, Vol. 48, No. 3, March 2000, pp. 911-917.
- [2] Miloš Trajković and Dušan Radović, “Performance Analysis of the DTMF Detector based on the Goertzel’s Algorithm”, in Proc. 14th Telecommunications Forum, TELFOR 2006, Serbia Belgrade, November 2006.
- [3] Suvad Selman, Raveendran Paramesran, “Comparative Analysis of Methods Used in the Design of DTMF Tone Detectors” Proceedings of the 2007 IEEE International Conference on Telecommunications and Malaysia International Conference on Communications, May 2007, Penang, Malaysia.
- [4] Yongbao Song, Wei Sun, Liankun Zhang, Mingming Liu, “The Software Generation and the Comparison of Decoding Approach

- of DTMF Signal”, 2010 Chinese Control and Decision Conference, IEEE, 2010.
- [5] Liu Yuying, “Research of DTMF Dialling System Based on the Goertzel Algorithm and MATLAB Simulation” Proceedings of the 2014 IEEE International Conference.
- [6] R. A. Valenzuela, “Efficient DSP based Detection of DTMF Tones”, in Proc. Global Telecommunications Conference, GLOBECOM 1990, Vol. 3, December 1990, pp. 1717-1721.
- [7] . M. J. Park, S. J. Lee, and D. H. Yoon, “Signal Detection and Analysis of DTMF Receiver with Quick Fourier Transform”, in Proc. 30th Annual Conference of IEEE Industrial Electronics Society, IECON 2004, Vol. 3, November 2004, pp. 2058-2064.
- [8] V. Musoko, M. Pánek, and M. Mudrová, “Detection of Information Carrier Signals using Band-pass Filters”, in Proc. 10th MATLAB Conference 2002, Prague, November 2002.
- [9] J. H. Beard, S. P. Given, and B. J. Young, “A Discrete Fourier Transform based Digital DTMF Detection Algorithm” in Proc. Mississippi State DSP Conference, Mississippi, Fall 1995, pp. 59-71.
- [10] A. M. Shatnawi, A. I. Abu-El-Haija, and A. M. Elabdalla, “A Digital Receiver for Dual Tone Multifrequency (DTMF) Signals”, in Proc. Technology Conference, Ottawa, Canada, May 1997, pp. 997-1002.
- [11] MATLAB GUI Building, Mathworks.inc. 2014.
- [12] R. Beck, A G. Dempster, and I. Kale, “Finite Precision Goertzel Filters used for Signal Tone Detection”, IEEE Transactions on Circuits and Systems II: Analog and Digital Signal Processing, Vol. 48, No. 7, July 2001, pp. 691-700.
- [13] M. Popović, “Efficient Decoding of Digital DTMF and R2 Tone Signalization”, Facta Univ. Ser., Elec.Energ., Vol. 16, No. 3, December 2003, pp. 389-399.
- [14] M. Bellanger, “Digital Processing of Signals”, New York: Wiley & Sons, 1984.
- [15] Oppenheim, A. V. and Schder, R. W., Digital Signal Processing, Prentice-Hall, Englewood Cliffs, NJ, 1975.