

Crown-Judd Wafer Check Valves

Fig. W-50 RF

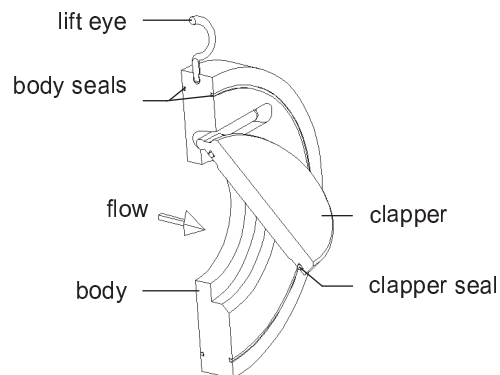
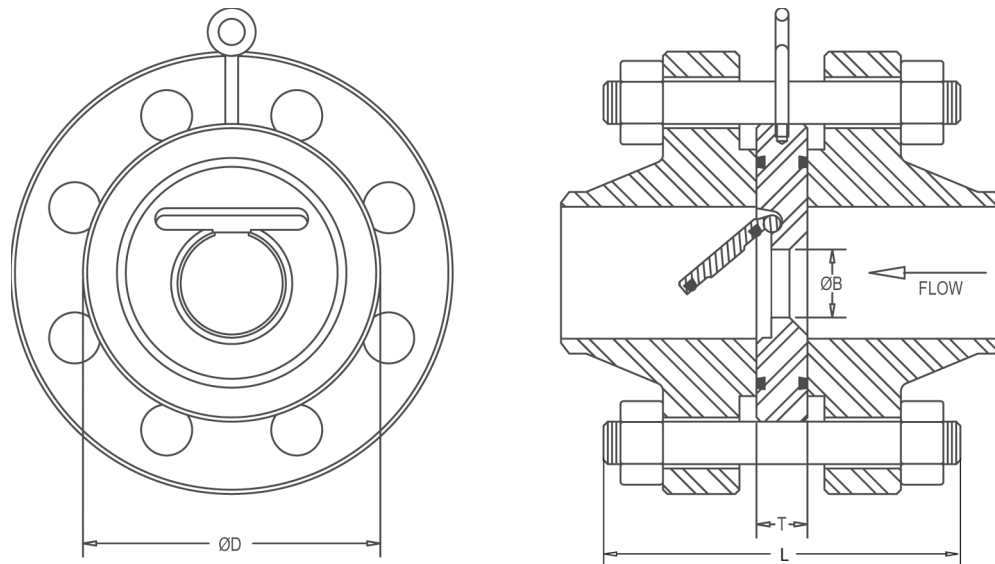

PART	STANDARD TEMP.	LOW TEMP.	OPTIONS
Body Material	A350 LF2, A105, A516-70 N		Contact Stream-Flo for Additional Materials
Clapper Material	316 SST, A516-70 N (2" and larger) CF8M (2" - 8" valves)		
Seal Material	VITON®	HSN	RTJ
Face Treatment	Serrated with O-Ring		

® Viton is a registered trademark of DuPont Dow Elastomers

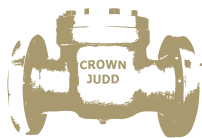

Crown-Judd Wafer Check Valves

Fig. W-50 RF

Size in. (DN)	Class (PN)	Weight lbs (kg)	Body Thickness "T" in. (mm)	Body Diameter "D" in. (mm)	Body Bore "B" in. (mm)	No. Stud Bolts	Stud Bolt Size in.	Stud Length "L" in. (mm)
2 (50)	150 (20)	3 (1.4)	0.75 (19)	4.13 (105)	1.00 (25)	4	5/8	4.25 (108)
	300 (50)	3 (1.4)	0.75 (19)	4.38 (111)	1.00 (25)	8	5/8	4.50 (114)
	400 (64)	3 (1.4)	0.75 (19)	4.38 (111)	1.00 (25)	8	5/8	5.25 (133)
	600 (100)	3 (1.4)	0.75 (19)	4.38 (111)	1.00 (25)	8	5/8	5.25 (133)
	900 (150)	5 (2.3)	0.75 (19)	5.63 (143)	1.00 (25)	8	7/8	6.75 (171)
	1500 (250)	7 (3.2)	0.75 (19)	5.63 (143)	1.00 (25)	8	7/8	6.75 (171)
2 1/2 (65)	2500 (420)	7 (3.2)	0.75 (19)	5.75 (146)	0.78 (20)	8	1	8.00 (203)
	150 (20)	4 (1.8)	0.75 (19)	4.88 (124)	1.50 (38)	4	5/8	4.50 (114)
	300 (50)	4 (1.8)	0.75 (19)	5.13 (130)	1.50 (38)	8	3/4	5.00 (127)
	400 (64)	4 (1.8)	0.75 (19)	5.13 (130)	1.50 (38)	8	3/4	5.75 (146)
	600 (100)	4 (1.8)	0.75 (19)	5.13 (130)	1.50 (38)	8	3/4	5.75 (146)
	3 (80)	150 (20)	4 (1.8)	0.75 (19)	5.38 (137)	1.86 (47)	4	5/8
300 (50)		5 (2.3)	0.75 (19)	5.88 (149)	1.88 (48)	8	5/8	5.25 (133)
400 (64)		5 (2.3)	0.75 (19)	5.88 (149)	1.88 (48)	8	3/4	6.00 (152)
600 (100)		5 (2.3)	0.75 (19)	5.88 (149)	1.88 (48)	8	3/4	6.00 (152)
900 (150)		7 (3.2)	0.75 (19)	6.63 (143)	1.88 (48)	8	7/8	6.75 (171)
1500 (250)		10 (4.5)	0.88 (22)	6.88 (175)	1.60 (41)	8	1 1/8	8.00 (203)
4 (100)	2500 (420)	11 (5.0)	1.13 (29)	7.75 (197)	1.50 (38)	8	1 1/4	8.25 (210)
	150 (20)	7 (3.2)	0.75 (19)	6.88 (175)	2.81 (71)	8	5/8	5.00 (127)
	300 (50)	7 (3.2)	0.75 (19)	7.13 (181)	2.81 (71)	8	3/4	5.50 (140)
	400 (64)	8 (3.6)	0.88 (22)	7.00 (178)	2.63 (67)	8	7/8	6.50 (165)
	600 (100)	10 (4.5)	0.88 (22)	7.63 (111)	2.63 (67)	8	7/8	6.75 (171)
	900 (150)	12 (5.5)	0.88 (22)	8.13 (206)	2.50 (64)	8	1 1/8	8.00 (203)
6 (150)	1500 (250)	17 (7.7)	1.25 (32)	8.25 (206)	2.20 (56)	8	1 1/4	9.25 (235)
	2500 (420)	27 (12.3)	1.50 (38)	9.25 (146)	2.20 (56)	8	1 1/2	11.75 (298)
	150 (20)	10 (4.5)	0.75 (19)	8.75 (222)	4.60 (117)	8	3/4	5.00 (127)
	300 (50)	16 (7.3)	0.88 (22)	9.88 (251)	4.60 (117)	12	3/4	6.00 (152)
	400 (64)	19 (8.6)	1.00 (25)	9.75 (248)	4.00 (102)	12	7/8	7.25 (184)
	600 (100)	25 (11.4)	1.13 (29)	10.50 (267)	4.00 (102)	12	1	8.00 (203)
8 (200)	900 (150)	36 (16.4)	1.38 (35)	11.38 (289)	4.00 (102)	12	1 1/8	9.25 (235)
	1500 (250)	45 (20.5)	1.75 (44)	11.13 (283)	3.84 (97)	12	1 3/8	12.25 (311)
	2500 (420)	*	2.25 (57)	12.50 (318)	3.50 (89)	8	2	16.00 (406)
	150 (20)	25 (11.4)	1.13 (29)	11.00 (279)	5.50 (140)	8	3/4	5.50 (140)
	300 (50)	32 (14.5)	1.13 (29)	12.13 (308)	5.50 (140)	12	7/8	6.75 (171)
	400 (64)	34 (15.5)	1.25 (32)	12.00 (305)	5.00 (127)	12	1	8.25 (210)
10 (250)	600 (100)	48 (21.8)	1.50 (38)	12.63 (321)	5.00 (127)	12	1 1/8	9.25 (235)
	900 (150)	71 (32.3)	1.75 (44)	14.13 (359)	5.00 (127)	12	1 3/8	10.75 (273)
	1500 (250)	84 (38.2)	2.25 (57)	13.88 (352)	4.50 (114)	12	1 5/8	14.00 (357)
	2500 (420)	141 (64.1)	3.00 (76)	15.25 (387)	3.75 (95)	12	2	18.25 (464)
	150 (20)	35 (15.9)	1.13 (29)	13.38 (340)	7.38 (187)	12	7/8	6.00 (152)
	300 (50)	70 (31.8)	1.50 (38)	14.25 (362)	7.38 (187)	16	1	7.75 (167)
12 (300)	400 (64)	*	2.00 (51)	14.13 (359)	6.75 (171)	16	1 1/8	9.75 (248)
	600 (100)	106 (48.1)	2.25 (57)	15.75 (400)	6.75 (171)	16	1 1/4	11.00 (279)
	900 (150)	*	2.25 (57)	17.13 (435)	6.75 (171)	16	1 3/8	11.75 (298)
	150 (20)	67 (30.5)	1.50 (38)	16.13 (410)	8.50 (216)	12	7/8	6.00 (152)
	300 (50)	99 (45.0)	2.00 (51)	16.63 (422)	8.50 (216)	16	1 1/8	8.75 (222)
	400 (64)	*	2.25 (57)	16.50 (419)	8.50 (216)	16	1 1/4	10.50 (267)
14 (350)	600 (100)	144 (65.5)	2.38 (60)	18.00 (457)	8.50 (216)	20	1 1/4	11.25 (279)
	900 (150)	214 (97.3)	3.13 (80)	19.63 (498)	8.00 (203)	20	1 3/8	13.25 (298)
	150 (20)	93 (42.3)	1.75 (44)	17.75 (451)	10.46 (266)	12	1	7.25 (184)
	300 (50)	*	2.00 (51)	19.13 (486)	10.46 (266)	20	1 1/8	9.25 (159)
	400 (64)	*	2.50 (64)	19.00 (483)	9.50 (241)	20	1 1/4	11.00 (279)
	600 (100)	*	2.63 (67)	19.38 (492)	9.50 (241)	20	1 3/8	12.50 (318)
16 (400)	150 (20)	140 (63.6)	2.00 (51)	20.25 (514)	12.00 (305)	16	1	7.50 (191)
	300 (50)	177 (80.5)	2.00 (51)	21.25 (540)	12.00 (305)	20	1 1/4	9.75 (248)
	400 (64)	*	2.50 (64)	21.13 (537)	11.50 (292)	20	1 3/8	11.50 (292)
	600 (100)	262 (119)	2.88 (73)	22.25 (565)	11.50 (292)	20	1 1/2	13.00 (330)
18 (450)	150 (20)	170 (77)	2.38 (60)	21.63 (549)	14.00 (356)	16	1 1/8	8.50 (216)
	300 (50)	*	3.00 (76)	23.50 (597)	14.00 (356)	24	1 1/4	11.00 (279)
	400 (64)	*	3.25 (83)	23.38 (594)	14.00 (356)	24	1 3/8	12.50 (318)
	600 (100)	337 (153)	3.25 (83)	24.13 (613)	14.00 (356)	20	1 5/8	14.25 (362)
20 (500)	150 (20)	233 (106)	2.50 (64)	23.88 (607)	16.00 (406)	20	1 1/8	8.75 (222)
	300 (50)	386 (175)	3.25 (83)	25.75 (654)	15.06 (383)	24	1 1/4	11.50 (292)
	400 (64)	392 (178)	3.50 (89)	25.50 (648)	14.75 (375)	24	1 1/2	13.25 (337)
	600 (100)	489 (222)	3.63 (92)	26.88 (683)	14.50 (368)	24	1 5/8	15.00 (381)
24 (600)	150 (20)	347 (158)	2.75 (70)	28.25 (718)	19.25 (489)	20	1 1/4	11.25 (279)
	300 (50)	629 (286)	3.75 (95)	30.50 (775)	19.25 (489)	24	1 1/2	13.00 (330)
30 (750)	150 (20)	649 (295)	2.00 (51)	34.75 (883)	24.13 (613)	28	1 1/4	11.00 (279)
32 (800)	150 (20)	*	3.50 (89)	37.00 (940)	26.00 (660)	28	1 1/2	13.50 (343)
36 (900)	150 (20)	1075 (489)	3.75 (95)	41.25 (1048)	27.75 (705)	32	1 1/2	14.50 (368)
42 (1100)	150 (20)	1675 (761)	4.25 (108)	48.00 (1219)	30.75 (781)	36	1 1/2	15.50 (394)

* Contact Stream-Flo Industries Ltd. for valve weight and for additional sizes or pressure classes not listed above.