



# IPLINK 3.0

## User Manual

VISLINK. Vislink House, 27 Maylands Avenue, Hemel Hempstead, Hertfordshire, HP2 7DE, United Kingdom.  
Telephone: +44 (0)1442 431300 • Facsimile: +44 (0)1442 431301 • Email: [sales@vislink.com](mailto:sales@vislink.com) • Website: [www.vislink.com](http://www.vislink.com)

Company Registered in England no. 1910243 VAT registration no. 448 636 222  
Registered Office: Marlborough House, Charnham Lane, Hungerford, Berkshire, RG17 0EY

## Document Disclaimer

The information contained in this manual remains the property of Vislink and may not be used, disclosed or reproduced in any other form whatsoever without the prior written permission of Vislink.

Vislink reserves the right to alter the equipment and specification appertaining to the equipment described in this manual without notification.

This document is supplied on the express terms that it is to be treated as confidential and that it may not be copied, used or disclosed to others for any purpose except as authorized by Vislink.

## Conventions

NOTE: Notes are used to convey additional information.

- ⚠ CAUTION: Cautionary notes are given where potential equipment damage could occur.
- ⚠ WARNING: A warning is shown where there is potential for personal injury, danger or death. This warning should be read and understood before attempting to carry out work on the equipment in use or any associated

## Vislink Product Support equipment.

Field repairs are not supported for this product. Return the unit for factory repair.

- ⚠ CAUTION: If any field repairs are attempted, there is a risk of damage to the equipment. If the equipment is under warranty, this may also affect the warranty coverage.

Service/Support Contacts:

Region	Contact Details
Worldwide	<a href="mailto:UKsupport@vislink.com">UKsupport@vislink.com</a>
	+44 (0) 1442 431410
	+44 (0) 1787 226227
Americas	<a href="mailto:USsupport@vislink.com">USsupport@vislink.com</a>
	+1 978 671 5929
	888 777 9221

When contacting Technical Support, please include the following information:

- Model number and serial number of the unit (located on a label on the bottom of each unit).  
.....
- Approximate date of purchase.  
.....

## Document History

Version	Date	Modification
.1	1/8/2021	First release of document.

# Table of Contents

<b>1. Introduction .....</b>	<b>1</b>
1.1. System Description .....	2
1.2. Key Features .....	2
1.3. Technical Characteristics .....	3
1.4. Applications .....	4
<b>2. Specifications.....</b>	<b>5</b>
<b>3. Front Panel.....</b>	<b>7</b>
3.1. USB Port .....	7
3.2. MNG LAN .....	7
3.3. LCD Touchscreen .....	7
3.3.1. Main Screen .....	8
3.3.2. Secondary Screen.....	8
3.4. Link LED .....	8
3.5. LOC Alarm LED.....	8
<b>4. Rear Panel .....</b>	<b>9</b>
4.1. ASI Ports .....	9
4.2. SFP Ports.....	9
4.3. Ethernet Ports .....	9
4.4. 9-Pin D-Sub Type Male (Alarm) .....	9
4.5. 9-Pin D-Sub Type Female (Control).....	10
4.6. RF In .....	10
4.7. RF Out.....	10
4.8. AC Power.....	10
4.9. XPIC Port .....	10
<b>5. Preparing for Operation .....</b>	<b>11</b>
5.1. Unpacking the IPLink .....	11
5.2. Power Requirements .....	11
5.3. Bands and Frequencies .....	12
5.3.1. RF Parameters .....	12
5.3.2. RF Band Support.....	12
5.4. Mounting IPLink.....	12
5.5. Connecting IPLink .....	13
5.5.1. Power Cycling IPLink.....	13
5.5.2. Standard System LED Behavior during Start-Up Process.....	13
5.6. System Configurations.....	14
<b>6. Web Interface.....</b>	<b>21</b>
6.1. Login.....	21
6.2. Web Interface Layout .....	22
6.3. General Tab.....	23
6.3.1. Overview Tab.....	23
6.3.2. Ports Tab .....	24
6.3.3. System Tab.....	25



6.3.4.	License Tab .....	26
6.4.	Events Page .....	27
6.4.1.	Actual Tab .....	27
6.4.2.	Historical Tab .....	28
6.4.3.	All Tab .....	28
6.5.	Counters Page .....	29
6.5.1.	Modem Tab .....	29
6.5.2.	Traffic Tab .....	31
6.5.3.	Management Tab .....	32
6.6.	Trends Page .....	33
6.6.1.	Actual Tab .....	33
6.6.2.	Historical Tab .....	34
6.7.	Inventory Page .....	35
6.7.1.	Inventory Tab .....	35
6.8.	System Page .....	36
6.8.1.	Mode Tab .....	36
6.8.2.	Description Tab .....	38
6.8.3.	Date & Time Tab .....	39
6.8.4.	Advanced Tab .....	40
6.9.	Access Page .....	41
6.9.1.	Users Tab .....	41
6.9.2.	Protocols Tab .....	42
6.9.3.	Certs&Keys Tab .....	43
6.10.	IP Page .....	44
6.10.1.	Addresses Tab .....	44
6.10.2.	SNMP Tab .....	45
6.10.3.	Advanced Tab .....	47
6.11.	Radio Page .....	49
6.11.1.	Parameters Tab .....	49
6.11.2.	ACM Tab .....	51
6.11.3.	Advanced Tab .....	52
6.12.	Ports Page .....	53
6.12.1.	MUX Tab .....	53
6.12.2.	EthVLAN Tab .....	55
6.12.3.	EthQOS Tab .....	57
6.12.4.	EMM Tab .....	58
6.13.	Alarms Page .....	60

6.13.1. Major Tab.....	60
6.13.2. Minor Tab .....	61
6.13.3. EMM Tab.....	62
6.14. Configuration Page .....	63
6.14.1. Save&Run Tab.....	63
6.14.2. Backup&Restore Tab.....	64
6.14.3. Factory default Tab.....	65
6.15. Firmware Page .....	66
6.15.1. Upgrade Tab.....	66
6.15.2. EMM Tab.....	67
6.16. Files Page.....	68
6.16.1. Exports Tab.....	68
6.16.2. Upload Tab.....	69
6.17. Logs Page.....	70
6.17.1. System Tab.....	70
6.17.2. Alarms Tab.....	71
6.17.3. Counter Tab .....	71
6.17.4. Commands Tab .....	72
6.17.5. Access Tab .....	73
6.17.6. SNMPd Tab .....	73
6.18. Troubleshooting Page .....	74
6.18.1. Assistant Tab.....	74
6.18.2. Detail-SYS Tab.....	75
6.18.3. Detail-IF Tab.....	75
6.18.4. Detail-RF Tab .....	76
6.19. Reboot Page .....	76
6.19.1. Reboot Tab.....	76
6.20. Terminal Page .....	77
6.20.1. Terminal Tab.....	77
6.21. IP Ping Page.....	78
6.21.1. Ping Tab.....	78
6.22. Sp. Analyzer Page.....	78
6.22.1. Channel1 Tab.....	78
6.23. Constellation Page .....	79
6.23.1. Channel1 Tab.....	79

<b>7. Optional External IPLink Expansion Module.....</b>	<b>82</b>
7.1. E1/T1 IPLink Expansion Module .....	82
7.1.1. LED Indicators on the IPL-IDU-E1T1-EXP – System Status.....	84
7.1.2. LED Indicators on the IPLink – IPL-IDU-E1T1-EXP – Port Status.....	85
7.1.3. Technical Specification of IPL-IDU-E1T1-EXP Module .....	85
7.2. Integrated ASI Module – IPL-IDU-ASI-EXP .....	86
7.2.1. Technical Specification for IPL-IDU-ASI-EXPEXT .....	87
<b>8. Optional External High Power Amplifier .....</b>	<b>89</b>
8.1. Front Panel Overview .....	89
8.1.1. Power Switch .....	89
8.1.2. LEDs .....	89
8.2. Rear Panel .....	90
8.2.1. AC Power.....	90
8.2.2. USB.....	90
8.2.3. Remote (9-Pin D-Sub Type Female) .....	90
8.2.4. IPLink (9-Pin D-Sub Type Male) .....	90
8.2.5. RF Out.....	90
8.2.6. RF In .....	90
<b>Appendix A Safety Information .....</b>	<b>91</b>
A.1. Calculating MPE.....	92
A.1.1. Conversions.....	92
A.1.2. User Input.....	92
A.1.3. Calculation Steps .....	92
A.1.4. Reference .....	93
A.1.5. Low Power .....	93
A.1.6. High Power .....	93
<b>Appendix B Payload Capacity, Bitrates &amp; TX Power .....</b>	<b>95</b>
B.1. IPLink RF Output (Before Branching Filtering).....	95
B.2. Bit Rates Transmission Power for IPLink .....	96
<b>Appendix C Configuration Notes .....</b>	<b>97</b>
C.1. Introduction.....	97
C.2. Connection and Login.....	97
C.2.1. Local Access over Ethernet LAN Interface .....	97
C.2.2. Login from the Web Interface.....	97
C.3. General System Configurations .....	98

C.3.1.	Info Page .....	98
C.3.2.	Date Page .....	98
C.3.3.	Access Rights.....	98
C.3.4.	Alarm Configuration.....	98
C.4.	Radio Configuration.....	98
C.5.	Port Configurations.....	99
C.5.1.	Design Mode – Single.....	99
C.5.2.	Design Mode – Multi .....	99
C.5.3.	Design Mode – Protected 1+1.....	101
C.5.4.	Design Mode – Aggregate 2+0 .....	101
C.5.5.	ETH VLAN Settings .....	101
C.6.	ETH Advanced Settings.....	101
C.6.1.	QoS Ethernet Setting.....	101
C.6.2.	Priority Abbreviations.....	101
C.6.3.	Port Default Priority .....	102
C.6.4.	IEEE Tag Priority .....	102
C.6.5.	IP v4/6 Priority.....	102
C.6.6.	Priority Policy .....	103
C.6.7.	Firmware and License Upgrade .....	104
C.6.8.	License Upgrade .....	104
C.6.9.	Firmware Upgrade .....	104
C.6.11.	Recommended Steps for Firmware Update .....	105
<b>Appendix D</b>	<b>Abbreviation List.....</b>	<b>106</b>

## Table of Figures

FIGURE 1-1	IPLINK FRONT PANEL .....	1
FIGURE 3-1	FRONT PANEL OVERVIEW .....	7
FIGURE 3-2	MAIN SCREEN OVERVIEW .....	8
FIGURE 4-1	REAR PANEL OVERVIEW .....	9
FIGURE 5-1	DUPLEX SYSTEM .....	14
FIGURE 5-2	TRANSMITTER .....	15
FIGURE 5-3	RECEIVER .....	16
FIGURE 5-4	DUPLEX HOT-STANDBY .....	17
FIGURE 5-5	TRANSMITTER – HOT STANDBY .....	18
FIGURE 5-6	RECEIVER – HOT STANDBY .....	18
FIGURE 5-7	DUPLEX WITH HPA .....	19
FIGURE 5-8	DUPLEX DIVERSITY WITH HPA .....	20
FIGURE 6-1	LOGIN PAGE .....	21
FIGURE 6-2	WEB INTERFACE OVERVIEW .....	22
FIGURE 6-3	OVERVIEW TAB .....	23
FIGURE 6-4	PORTS TAB .....	24
FIGURE 6-5	SYSTEM TAB OVERVIEW .....	25
FIGURE 6-6	LICENSE TAB .....	26
FIGURE 6-7	ACTUAL TAB .....	27
FIGURE 6-8	HISTORICAL TAB .....	28
FIGURE 6-9	ALL TAB .....	28
FIGURE 6-10	MODEM TAB .....	29
FIGURE 6-11	TRAFFIC TAB .....	31
FIGURE 6-12	MANAGEMENT TAB .....	32
FIGURE 6-13	ACTUAL TAB .....	33
FIGURE 6-14	HISTORICAL TAB .....	34
FIGURE 6-15	INVENTORY TAB .....	35
FIGURE 6-16	MODE TAB .....	36
FIGURE 6-17	DESCRIPTION TAB .....	38
FIGURE 6-18	DATA & TIME TAB .....	39
FIGURE 6-19	ADVANCED TAB .....	40
FIGURE 6-20	USERS TAB .....	41
FIGURE 6-21	PROTOCOLS TAB .....	42
FIGURE 6-22	CERTS&KEY .....	43
FIGURE 6-23	ADDRESSES TAB .....	44
FIGURE 6-24	SNMP TAB .....	45
FIGURE 6-25	ADVANCED TAB .....	47
FIGURE 6-26	PARAMETERS TAB .....	49
FIGURE 6-27	ACM TAB .....	51
FIGURE 6-28	ADVANCED TAB .....	52
FIGURE 6-29	MUX TAB .....	53
FIGURE 6-30	ETHVLAN TAB .....	55
FIGURE 6-31	ETHQOS TAB .....	57
FIGURE 6-32	EMM TAB .....	58

FIGURE 6-33 MAJOR TAB .....	60
FIGURE 6-34 MINOR TAB.....	61
FIGURE 6-35 EMM TAB .....	62
FIGURE 6-36 SAVE&RUN TAB.....	63
FIGURE 6-37 BACKUP&RESTORE TAB.....	64
FIGURE 6-38 FACTORY DEFAULT TAB.....	65
FIGURE 6-39 UPGRADE TAB.....	66
FIGURE 6-40 EMM TAB .....	67
FIGURE 6-41 EXPORTS TAB.....	68
FIGURE 6-42 UPLOAD TAB.....	69
FIGURE 6-43 SYSTEM TAB.....	70
FIGURE 6-44 ALARMS TAB.....	71
FIGURE 6-45 COUNTERS TAB.....	71
FIGURE 6-46 COMMANDS TAB .....	72
FIGURE 6-47 ACCESS TAB.....	73
FIGURE 6-48 SNMP TAB.....	73
FIGURE 6-49 ASSISTANT TAB .....	74
FIGURE 6-50 DETAIL-SYS TAB.....	75
FIGURE 6-51 DETAIL-IF TAB.....	75
FIGURE 6-52 DETAIL-RF TAB .....	76
FIGURE 6-53 REBOOT TAB.....	76
FIGURE 6-54 TERMINAL TAB .....	77
FIGURE 6-55 PING TAB.....	78
FIGURE 6-56 CHANNEL1 TAB.....	78
FIGURE 6-57 CHANNEL1 TAB.....	79
FIGURE 7-1 EI USER PORT PINOUT OVERVIEW.....	82
FIGURE 7-2 RJ45 ETHERNET TO BNC E1 CABLING OVERVIEW .....	84
FIGURE 8-1 OPTIONAL EXTERNAL DHPA FRONT PANEL OVERVIEW.....	89
FIGURE 8-2 OPTIONAL EXTERNAL HP AMP REAR PANEL OVERVIEW .....	90

## Table of Tables

TABLE 2-1 SPECIFICATIONS OVERVIEW .....	5
TABLE 3-1 FRONT PANEL ID.....	7
TABLE 4-1 REAR PANEL ID .....	9
TABLE 4-2 9-PIN D-SUB TYPE MALE PINOUT .....	9
TABLE 4-3 9-PIN D-SUB TYPE FEMALE PINOUT.....	10
TABLE 7-1 EI USER PORT PINOUT .....	83
TABLE 7-2 RJ45 ETHERNET TO BNC E1 CABLING PINOUT.....	84
TABLE 7-3 TRAFFIC INTERFACES .....	85
TABLE 7-4 NETWORK MANAGEMENT SYSTEM .....	85
TABLE 7-5 MISCELLANEOUS.....	86
TABLE 7-6 TRAFFIC INTERFACES .....	87
TABLE 7-7 MISCELLANEOUS.....	87
TABLE 8-1 RF-IN LED.....	89
TABLE 8-2 RF-OUT LED.....	89
TABLE 8-3 BYPASS LED.....	89

TABLE 8-4	9-PIN D-SUB PINOUTS .....	90
TABLE A-1	REQUIREMENTS AND HARMONIZED ETSI STANDARDS .....	91
TABLE A-2	REQUIREMENTS AND HARMONIZED FCC STANDARDS .....	91
TABLE A-3	MPE MINIMUM SAFE DISTANCES .....	91
TABLE A-4	MPE LOW POWER MINIMUM SAFE DISTANCES .....	93
TABLE A-5	MPE HIGH POWER MINIMUM SAFE DISTANCES .....	93
TABLE B-1	RF MODULE OUTPUT .....	95
TABLE B-2	CHANNEL BANDWIDTH .....	96

This page is intentionally unused.



# 1. Introduction



Figure 1-1 IPLink Front Panel

IPLink is an Internet Protocol-centric microwave radio specifically designed for broadcasting. Its all-indoor, full duplex, bi-directional platform provides both GigE Ethernet data plus ASI interfaces. The IPLink transceiver combines the features of a broadcast digital microwave point-to-point radio system with the modern efficiencies of a high-capacity long-distance bi-directional IP microwave radio design.

It allows the broadcaster to smoothly migrate from the traditional ASI transport platform to a future IP-centric system architecture. The system delivers ultra-high linear RF output performance coupled with the reliability that Low Density Parity Check forward error correction (LDPC FEC) affords in controlling errors in data transmissions over long or unreliable microwave paths.

A key advantage of the IPLink is that it allows BAS 7 & 13 GHz simplex links to be transformed into affordable duplex IP Ethernet microwave systems within a T/R channel spacing as close as 75 MHz systems are available in Simplex, Duplex, Hot-Standby and Spatial Diversity Receive configurations. IPLink digital microwave system is designed to operate at channel bandwidths up to 56 MHz and modulations from QPSK to 256QAM.

IPLink is designed for high-performance Point-to-Point (PtP) digital microwave links with adjustable data rate from 10 to 360 Mbps, modulation and channel bandwidth dependent. The IPLink includes a user selectable Adaptive Code Modulation (ACM) feature that provides transport stream continuity based upon a data rate that automatically scales according to the quality of the wireless link. The IPLink is specifically designed to address wireless IP-centric transport requirements where interface with legacy ASI infrastructures are still necessary.

The IPLink supports both ETSI (European Telecommunications Standards Institute) and ANSI (American Standards Association) licensed frequency bands and channel bandwidths standards.

## 1.1. System Description

The IPLink is an all-indoor microwave radio system that connects with tower mounted antennas via elliptical waveguide. It consists of a high RF output transceiver (TX/RX) with an Ethernet baseband IP modem, all housed within a 2RU x 19" EIA rack-mount chassis. Transmit and Receive frequency channel spacing is user selectable within a 75 MHz T/R separation. Non-protected (1+0) and hot-standby (1+1) system configurations are available. The IPLink provides up to three GigE and four ASI (optional) user interfaces and includes a robust web-based remote system management and monitoring GUI. Additional ASI or E1/T1 circuits may be connected to the system via a high-speed optical interface

## 1.2. Key Features

expansion chassis.

The IPLink system is technically characterized by the following basic features:

- All-indoor, space efficient 2RU x 19" (48 cm) rack-mount
- Ultra-high linear broadband RF power amplifiers
- Exceptional System Gain & Unparalleled Receiver Sensitivity
- High capacity ASI & Gigabit Ethernet IP data transport
- Automatic Transmitter Power Control
- Adaptive Code Modulation to adjust data rates based on link connectivity
- User selectable modulations from QPSK to 256 QAM
- ANSI and ETSI channel bandwidths
- Intuitive Web-based GUI for monitoring/control

### 1.3. Technical Characteristics

- Standard licensed ETSI and ANSI frequency bands
- 6, 7, 8 & 13 GHz RF Band Support
- Modulation schemes:
  - QPSK, 8 PSK, 16/32/64/128/256 QAM
- Channel bandwidth
  - ETSI standards 7/14/27.5/28/40 and 56 MHz
  - ANSI standards 10/20/25/30/40/50 and 60 MHz
- LDPC based Forward Error Correction
- Hitless Adaptive modulation (ACM)
- Four basic design modes (SW setting):
  - Simplex – one-way data stream over air
  - Duplex – bi-directional data streams over air
  - PROTECTED – 1+0 configuration in HSB/SD/FD modification
  - AGGREGATE – 2+0 configuration with true capacity doubling
- Two functional options (SW setting):
  - AES128, AES256 – AES encryption for high system security
  - PTP1588 – option which ensures IEEE1588 support
- Integrated traffic ports:
  - 2x Gigabit Ethernet ports (10/100/1000Base-T) 2 for user data traffic and one dedicated for management access (can be configured for data traffic)
  - 2x Fiber optic interfaces, one for GigE port extension, and another for EMM module connection or IPLink interconnection (protection, aggregation)
- SyncE support in each design mode
- Integrated data verification system of received corrupted packets (CRC)
- Integrated BER tester and measurement of the nature of received signal (MSE, modulation diagram of received data)
- ATPC function support (Automatic Transmit Power Control)
- Integrated spectral analyzer for the detection of the free channel, or alternatively for detection of interference with the particular band
- Unified standard management IP access – TELNET, HTTP, SNMP v.2c
- Secure management IP access - SSH, HTTPS, SNMP v.3

## 1.4. Applications

- Studio-to-Transmitter Links (STL)
- Transmitter-to-Studio Links (TSL)
- Inter-city Relay Backhauls (ICR)
- Multi-hop Microwave Relay Systems
- High-capacity IP Microwave Systems

The core of the unit is DSP module that generates a signal for the intermediate frequency output to the internal RF transceiver unit and processes radio frequency (RF) input/output from/to the antenna.

As stated above, IPLink is fitted with three 1000Base-T (RJ45) user ports, where one port is typically reserved for system management. Two fiber optic interfaces are intended either for additional Gigabit Ethernet connection or for IPLink interconnection (1+1/2+0) (labeled as SFP) or for capability extension by connection via EMM (External Multiplexer Module Option).

The Management system is based on TCP Internet Protocol (TCP/IP). The RF unit's management is integrated directly into the command set of IPLink; an integral part of this unit's software. For the management itself there is used, either character-oriented IP access (TELNET, SSH) or Web based GUI (HTTP, HTTPS) or SNMP based system management. The IPLink unit should be connected to power supply with a nominal voltage of 115-120 or 220-240 VAC.

## 2. Specifications

Component	Features	Details
<b>RF</b>	RF Power Output Level (prior to filter branching)	+34dBm to +27dBm <sup>1</sup> @ 6 GHz, +33dBm to +26dBm @ 7 GHz +32 dBm to +25 dBm @ 8 GHz, +29dBm to +22dBm <sup>1</sup> @ 13 GHz
	RF Band Support <sup>2</sup>	6.425 – 7.125 GHz (FCC TV-BAS) 7.100 – 7.900 GHz (ETSI) 7.725 – 8.500 GHz (ETSI) 12.700 – 13.250 GHz (FCC TV-BAS)
	Channel Filter Branching Network Assemblies <sup>3</sup>	50 MHz typ. T/T & R/R @ 7 & 13 GHz FCC-BAS 75 MHz MINIMUM. T/R @ 7 & 13 GHz FCC-BAS Waveguide Interface: WR137 @ 6 GHz, WR75 @ 13 GHz
	Automatic Transmitter Power Control (ATPC)	-
<b>Data Transport</b>	Modulation	QPSK, 8PSK, 16 QAM, 32 QAM, 64 QAM, 128 QAM & 256 QAM
	Data Throughput Capacity (one-way)	10 Mbps to 350 Mbps
	Adaptive Code Modulation	hitless 0ms
	Encryption	AES 256
<b>Power</b>	100W (power consumption) switching	AC (90-132V & 180-264V @ 47 – 63 Hz)
<b>User Interface</b>	Ethernet (payload)	2 x 100/1000 Base-T, RJ-45 Gigabit Ethernet line rates scalable up to 360 Mbps IPv4 and IPv6 VLAN 802.1Q 64 level DiffServ (DSCP) QoS or 8 level 802.1p in 4 prioritization queues with VLAN support
	A SI (payload)	4 x ASI simplex transmit (BNC-F) 4 x ASI simplex receive (BNC-F) 4 x ASI individually configured per direction for duplex (BNC-F)
	Local and Remote Link Web-Browser Management	1 x 100/1000 Base-T (RJ-45)
	System Management Interface	Hot-Standby (1+1) and Space Diversity 1 x DB9 for RF PA & RSL switching 1 x DB9 for alarm fault switching
<b>Mechanical</b>	Dimensions	2 RU x 19" (48cm) EIA Rack Mount 16.5" depth (42cm) exclusive of filter branching
	Weight	18 lbs. (8.2 kg) approx.
<b>Environmental</b>	Temperature Range	0° to +50°C (+32° to +122°F) Operational -40° to +70°C (-40° to +158°F) Storage
	Humidity	90% max. non-condensing
	FCC Type Certification in Accordance with CFR 47 Part, Subpart J	CFR 47, Part 74, subpart J CFR 47, Part 101, subparts C, H and I

<b>Regulatory</b>	FCC part 15 EMC unintentional emission radiators	-
	ETSI: EN 301 489-1, 489-28, EN 302 064-1	-
	Safety per EN/CE EN60950	-

Table 2-1 Specifications Overview

- <sup>1</sup> - Modulation dependent.
- <sup>2</sup> - Consult factory for additional RF band support.
- <sup>3</sup> - Consult factory for additional WG interface availability.

### 3. Front Panel



Figure 3-1 Front Panel Overview

Drawing ID	Function
1	USB port
2	MNG LAN
3	LCD Touchscreen
4	Link LED
5	LOC Alarm LED

Table 3-1 Front Panel ID

#### 3.1. USB port

Upload files using USB drive for firmware updates if available.

#### 3.2. MNG LAN

1x RJ45, Local Area Network host communication port.

Provides 10/100/1000 Base-T Ethernet connection to a PC via a Web browser for local or remote control of the radios that form the link.

#### 3.3. LCD Touchscreen

The front panel touchscreen conveys local and remote, read-only, setup information. System configuration can be set with the Web interface when you connect to the front panel Management LAN Ethernet port and connect with the IP address shown at the bottom of the touchscreen.

When you press the touchscreen for at least 20 seconds, a secondary screen displays, showing information about the presence of an optional High Power Amplifier (HPA) and/or redundant power supplies (PSU).

### 3.3.1. Main Screen



Figure 3-2 Main Screen Overview

The main screen displays the following information:

- Transmission Frequency (MHz)
- Receiver Frequency (MHz)
- Modulation Status:
  - First three digits refer to modulation type (e.g. 004 = 4PSK, 016=16QAM)
  - Next five digits refer to bandwidth in kHz
  - Final two digits refer to waveform type (always use 03 for IPLink indoor unit)
- Transmission Power (dBm)
- Receiver Level (dBm)
- System Throughput (Mb/s)
- Alarms
- Current IP Address and Netmask

### 3.3.2. Secondary Screen

On the secondary screen the following items will be displayed:

- HPA Attached – Indicates the presence of an optional High Power Amplifier (HPA). When this is enabled an alarm will indicate if the HPA is unresponsive. In most situations this option will be turned off.
- PSU (Redundant Power Supply) Enabled – Configures the unit to be aware of the presence of an optional redundant power supply (PSU). An alarm will also be indicated should such power supplies be inactive.
- SW Version – Displays the software version.
- Exit – Press this button to return to the primary touch screen.

## 3.4. Link LED

This LED is lit green when the transceiver establishes a connection with a remote transceiver. If there is no connection, the LED will be lit red.

## 3.5. LOC Alarm LED

Indicates the current alarm status of the Local IPLink transceiver.

If there are no alarms, then this LED is lit green. If there is a minor alarm (Alert), the LED will be lit amber. If there is a major alarm, the LED will be lit red.



## 4. Rear Panel



Figure 4-1 Rear Panel Overview

Drawing ID	Function	Additional Information
6	ASI ports	-
7	SFP ports	The SFP ports are used for external EMM extension as well as 1+1 and diversity configurations
8	Ethernet ports	-
9	9-pin D-Sub type male (Alarm)	Alarm interface
10	9-pin D-sub type female (Control)	Control interface
11	RF Out	RF Output to filter branching network.
12	RF In	RF Input from filter branching network RF out.
13	AC power	
14	XPIC Port	Future application / Need licensing

Table 4-1 Rear Panel ID

### 4.1. ASI Ports

Four BNCs, ASI configurable input or output.

### 4.2. SFP Ports

Two fibre optic control for expansion modules.

### 4.3. Ethernet Ports

Two RJ-45, 10/100/1000 Base-T data traffic.

### 4.4. 9-Pin D-Sub Type Male (Alarm)

Alarm relay closure - the Normally Closed signals are closed when the unit is operating correctly, and will be open when there is an alarm. Alarm 1 and alarm 2 trigger at the same time, they are two separate poles off in the same relay.

Pin	Signal
1	Alarm 1 Relay common
2	Alarm 1 Relay Normally Closed
3	Alarm 2 Relay Normally Open
4	NC
5	NC
6	Alarm 1 Relay Normally Open
7	Alarm 2 Relay common
8	Alarm 2 Relay Normally Closed
9	NC

Table 4-2 9-Pin D-Sub Type Male Pinout

#### 4.5. 9-Pin D-Sub Type Female (Control)

This connector is used to communicate with an external DHPA (rack mounted Digital High- Power Amp).

Pin	Signal
1	NC
2	RS282 TX
3	RS282 RX
4	NC
5	GND
6	NC
7	NC
8	NC
9	NC

Table 4-3 9-Pin D-Sub Type Female Pinout

#### 4.6. RF In

SMA 50Ω female connector – RF signal in from antenna.

#### 4.7. RF Out

SMA 50Ω female connector – RF signal in from antenna.

#### 4.8. AC Power

Provides AC power to the unit.

#### 4.9. XPIC Port

Future application / Requires Licensing

## 5. Preparing for Operation

### 5.1. Unpacking the IPLink

Before you install your IPLink transceiver, carefully unpack your new equipment to avoid accidental damage:

- Locate all parts and accessories and verify that they are listed on the packing list. DO NOT discard the container or packing material until you have inspected the equipment and are sure there is no shipping damage. The container and packing must be available in case you need to file a damage claim with the shipping carrier.
- Inspect the equipment for damage and that it is clean and dry.
- Inspect the cables, connectors, switches, and displays to ensure that they are not broken, damaged, or loose.

If you discover damage after unpacking the system, report the damage as follows:

- Immediately file a claim with the shipping carrier.
- Forward a copy of the damage report to Vislink Customer Service.
- Contact Vislink Customer Service to determine the disposition of the equipment. See inside the front page for contact information.

### 5.2. Power Requirements

The IPLink has the following power requirements:

Supply Voltage:

- AC (90-132V & 180-264V @ 47 – 63 Hz)

Power Consumption:

- 100W nominal

**⚠ CAUTION:** Ensure that the power supplied matches the power required by the equipment.

## 5.3. Bands and Frequencies

### 5.3.1. RF PaRAMeters

RF Power Output Level (prior to filter branching):

- +34dBm to +27dBm\* @ 6 GHz
- +33dBm to +26dBm\* @ 7 GHz
- +32dBm to +25dBm\* @ 8 GHz
- +29dBm to +22dBm\* @ 13 GHz

\* (modulation dependent)

### 5.3.2. RF Band Support

The IPLink uses the following frequency bands:

- 6.425 – 7.125 GHz (FCC TV-BAS)
- 7.100 – 7.900 GHz (ETSI)
- 7.725 – 8.500 GHz (ETSI)
- 12.700 – 13.250 GHz (FCC TV-BAS)

\*Consult factory for additional RF band support

- ⚠ WARNING:** High levels of RF power are present in the unit. Exposure to RF or microwave power can cause burns and may be harmful to health. Remove power from the unit before disconnecting any RF cables and before inspecting damaged cables and/or antennas. Avoid standing in front of high gain antennas (such as a dish antenna) and never look into the open end of a waveguide or cable where RF power may be present.

## 5.4. Mounting IPLink

The 2RU IPLink generates heat during normal operation. Give careful consideration to mounting the transceiver to direct heat away from the housing. For adequate cooling, ensure that discretionary cooling or ventilating equipment is used in the local and remote installations.

## 5.5. Connecting IPLink

Figure 4-1 shows the overview of the rear panel connections to and from the IPLink transceiver. Use the Management Ethernet port (MNG ETH) on the front panel to connect to a switch or router or to connect to a modem for an internet connection. Connecting the local IPLink to the internet allows you to configure it via its web interface (see Section 6). You can connect to it a numbers of way using the correct IP address via a compatible web browser i.e. using a tablet or PC.

NOTE: All connectors should be tool-tight. Thumb tight connections are not suitable for reliable operation.

### 5.5.1. Power Cycling IPLink

After applying power to the IPLink, it will take approximately 20 seconds before it begins normal operating state. When the transceiver is starting up, watch the system status diodes LINK, LOC ALARM.

### 5.5.2. Standard System LED Behavior during Start-Up Process

The following list shows the process and behaviour of each LED on the IPLink:

- POWER LED on the power switch should light after power up.
- Once the link is established between the two radios, the LINK led will turn green.
- If no alarms are present, the LOC ALARM led will turn green. If alarms are present, then the LOC ALARM led turns red.

## 5.6. System Configurations

The following illustrations highlight the possible system configurations.

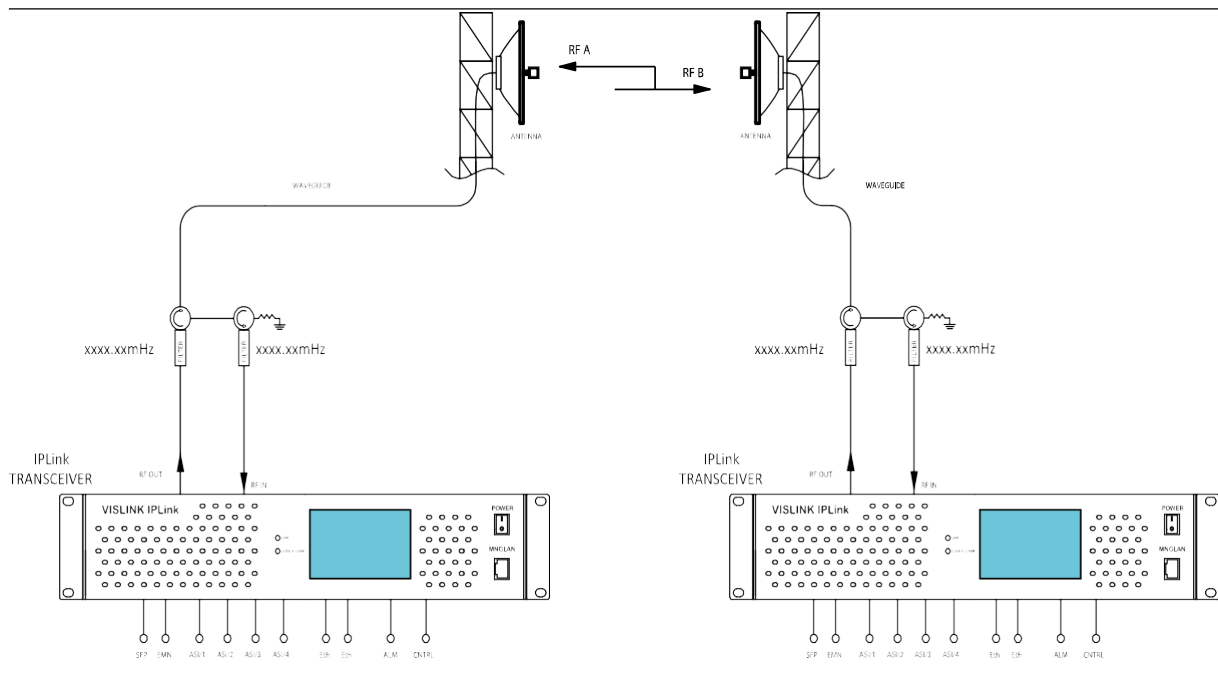

Figure 5-1 Duplex System

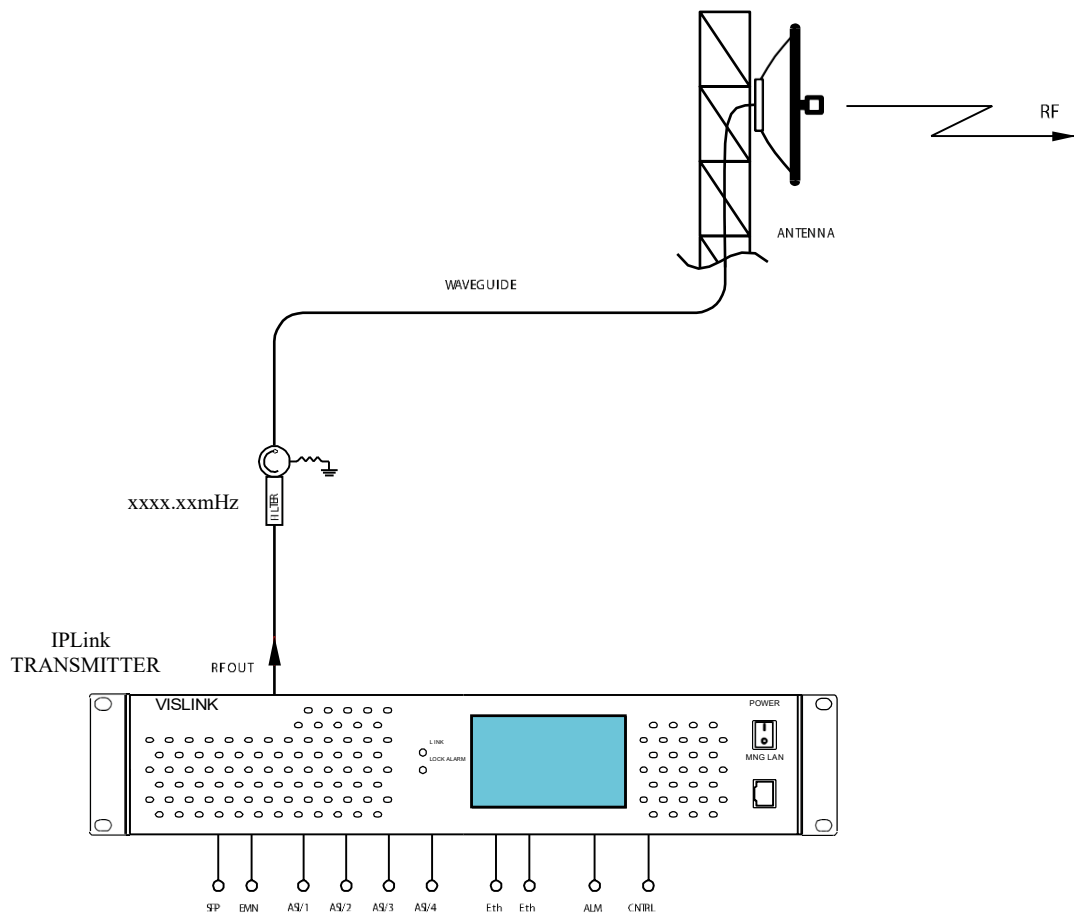

Figure 5-2 Transmitter

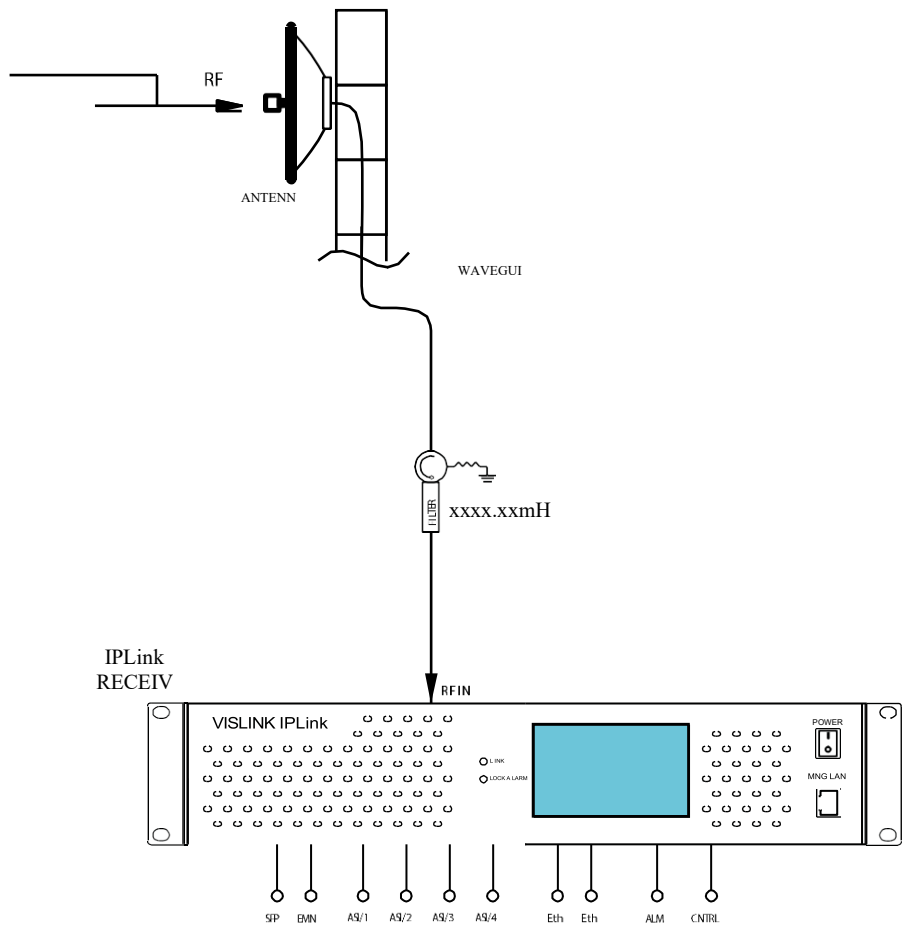

Figure 5-3 Receiver



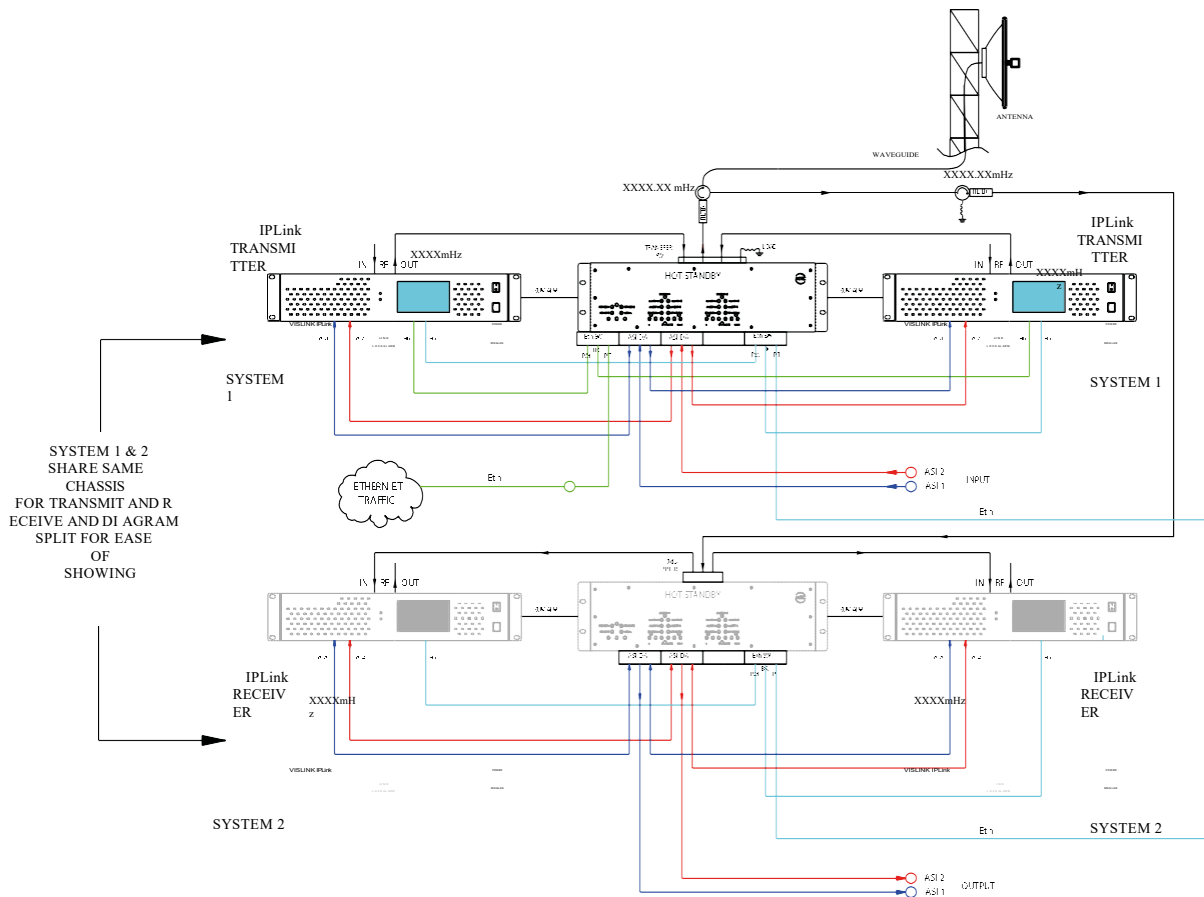

Figure 5-4 Duplex Hot-Standby

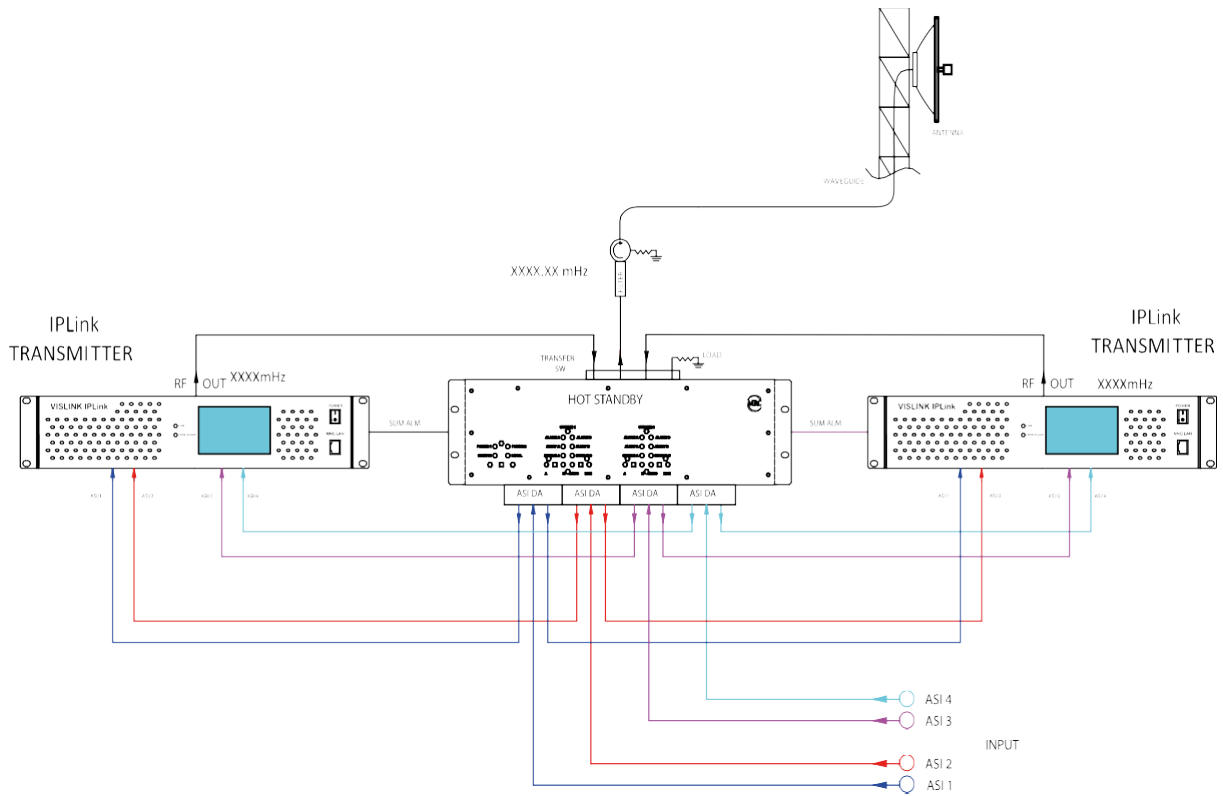

Figure 5-5 Transmitter – Hot Standby

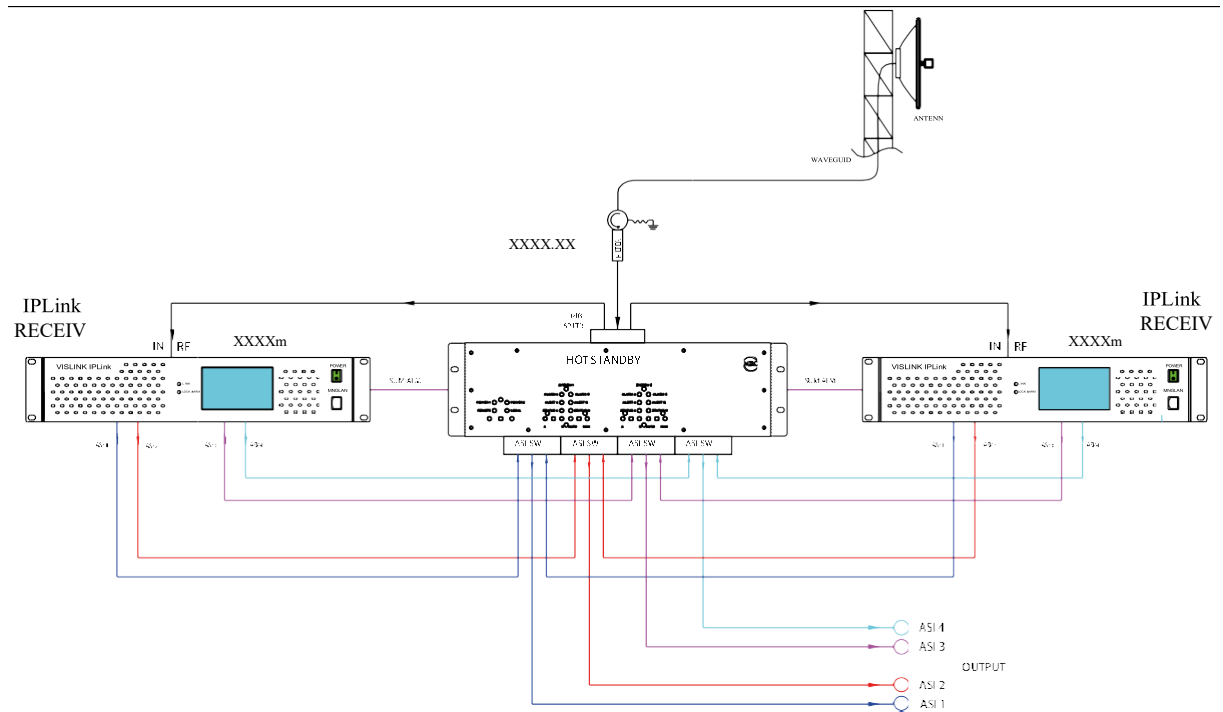

Figure 5-6 Receiver – Hot Standby

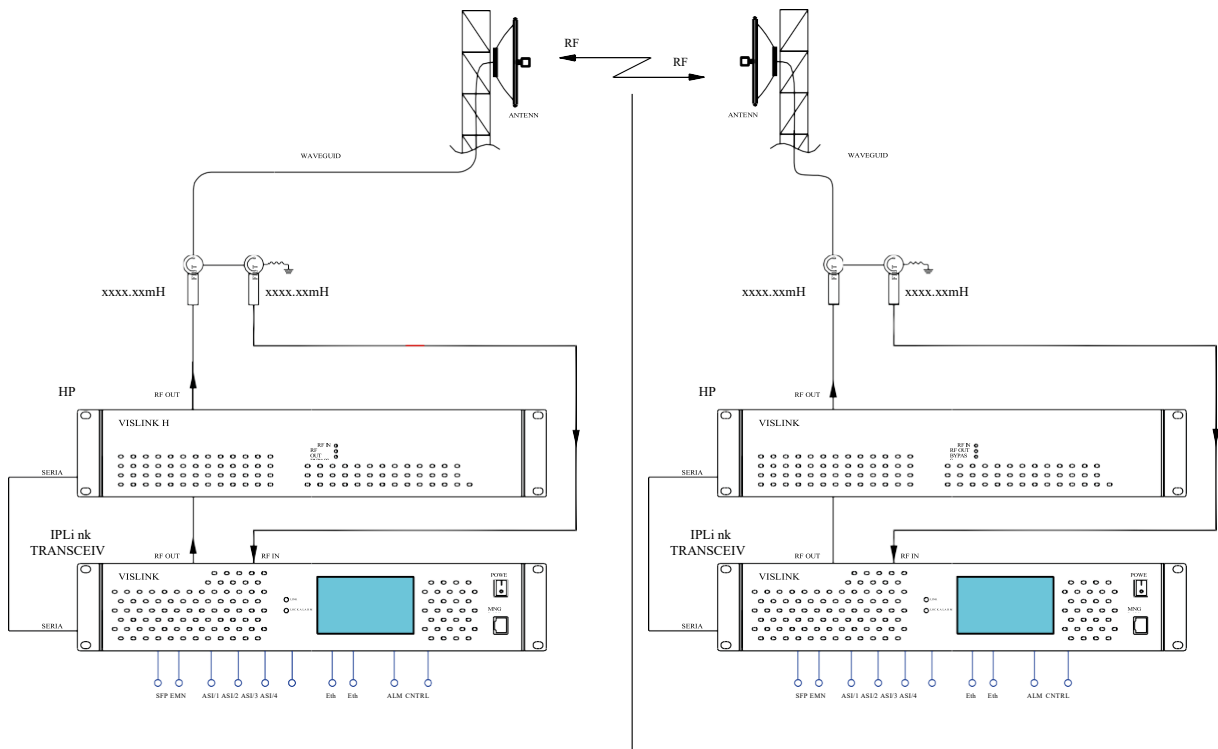

Figure 5-7 Duplex with HPA

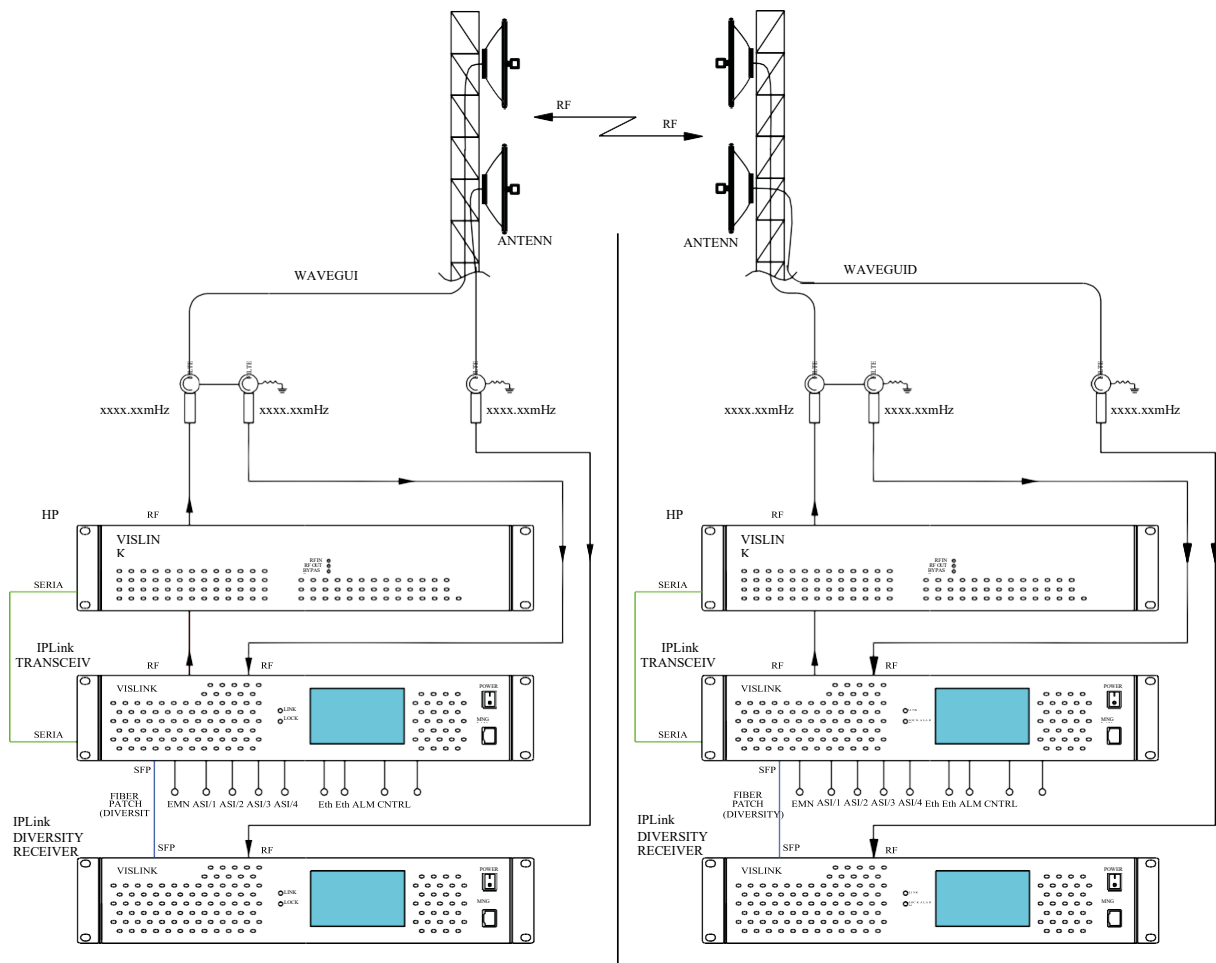

Figure 5-8 Duplex Diversity with HPA

## 6. Web Interface

### 6.1. Login

Connect a PC to the local Management port (MNG LAN) located on the front panel of the IPLink transceiver and open a Web browser. Navigate to the IPLink Browser by inserting the specific radio IP address (found on front panel display, factory set subnet of 192.168.0.xxx) using the URL field of either Google Chrome, Mozilla Firefox version 3.xx and higher, browsers which are recommended, (IE 5 and above or OPERA 9.xx and above are also compatible) on proper connection the IPLink the login window will be displayed as shown below.

To login you can use the default credentials:

- Login: admin
- Password: secret

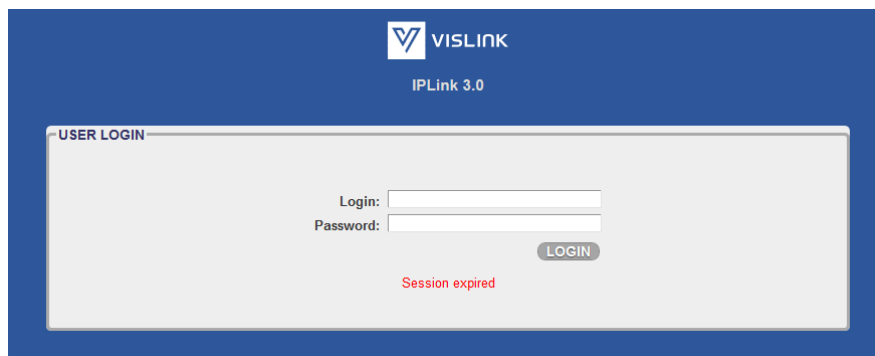

Figure 6-1 Login Page

## 6.2. Web Interface Layout

After a successful login to the management system, the General Tab of the Web interface appears. The main window is divided into a few essential sections as displayed below.

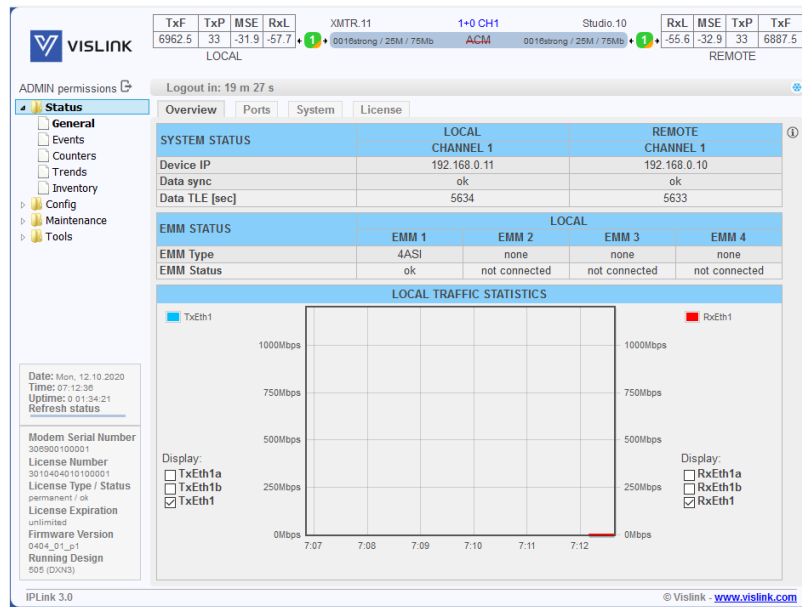

Figure 6-2 Web Interface Overview

## 6.3. General Page

### 6.3.1. Overview Tab

After logging in, the General Tab, Overview displays.

SYSTEM STATUS – Overall system status:

Device IP – IP addresses of devices in the link

Data Encryption – encryption status

Data Sync – modem synchronization status

Data TLE – time since last error occurrence

EMM STATUS – The status of attached EMM chain. Note this frame will be shown only when an EMM card is attached and enabled

LOCAL TRAFFIC STATISTICS – An interactive graph depicting the link throughput since login

### Side Bar Information Frame

The Side Bar located on the left GUI edge shows the summary of important device information:

Modem Serial Number – Device Serial Number. It is shown only when differs from the *License Number*.

License Number – The license number.

License Type / Status – Shows if the license is permanent or time-limited and its status.

License Expiration – Shows the remaining time until the license expires.

Firmware Version – Version of the device firmware.

Running Design – Active design type.

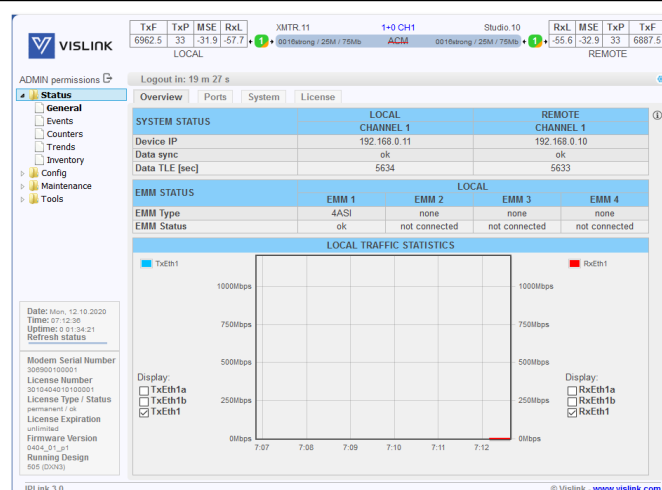

Figure 6-3 Overview Tab

## 6.3.2. Ports Tab



Figure 6-4 Ports Tab

This frame provides a summary status of all physical IO ports of the device.

- Link Status – status of a port as detected by the device (speed, duplex mode, link, administrative down status)
- Mode – actual port settings (speed/duplex, administrative down)
- Flow Control – actual duplex flow control mechanism settings
- VLAN group – actual port separation

You can change these setting on the *Config/Ports* page.

EMM Module Status – Summary status of all attached EMM cards

EMM RX PORT STATUS - The detailed status of all ports of each attached EM. For detailed description of all possible values, please refer to the *Config/Ports/EMM* page



### 6.3.3. System Tab

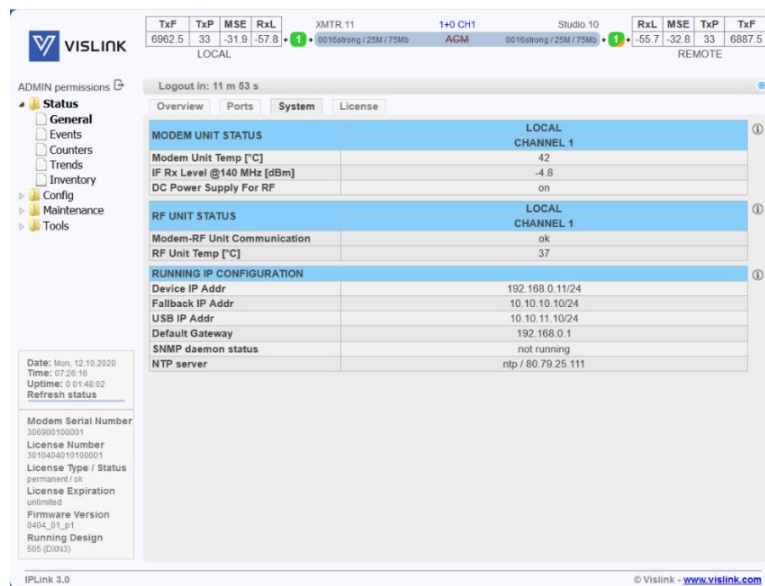

Figure 6-5 System Tab Overview

#### MODEM UNIT STATUS –

This frame shows the system status of the modem.

- Modem Unit Temp – temperature of the modem part
- IF Rx Level @140 Mhz – the IF signal strength detected on cable input of the modem part
- DC Power Supply For RF – the actual status of power supply for the radio part

#### RF UNIT STATUS –

The basic status details of the RF part(s).

- Modem-RF Unit Communication – status of telemetry communication between the device and radio part
- RF Unit Temp – temperature read from the radio part

#### RUNNING IP CONFIGURATION -

This frame contains information about running IP configuration.

- Device IP Addr – the IP address of this device
- Fallback IP Addr – the fallback IP address of this device
- USB IP Addr – the fallback USB IP address of this device
- Default Gateway – the default gateway IP address of this device
- SNMP daemon status – the status of the inbuilt SNMP daemon
- NTP server – the time synchronization server configuration

Issue: No.

25

Ref: IPLK-ASUM-8000

Copyright © Vislink

### 6.3.4. License Tab

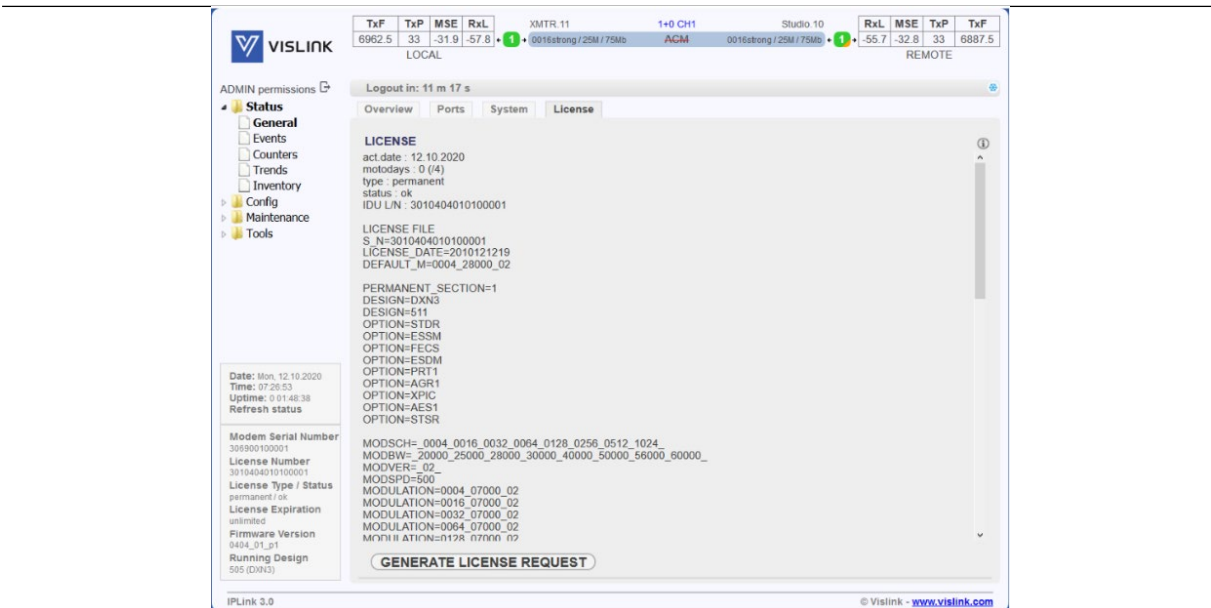

Figure 6-6 License Tab

This frame displays the content and status of the currently used license with available modulation schemes and options as well as remaining license time when a time-limited license is in use.

By means of pressing the GENERATE LICENSE REQUEST, you can generate and download a License Request (licreq\_SN\_timestamp.afw) file which will be required for extending of time-limited License. It can be downloaded from *Maintenance/Files/Exports* frame

## 6.4. Events Page

The Alarms Tab provides the means to display three pages of information.

### 6.4.1. Actual Tab

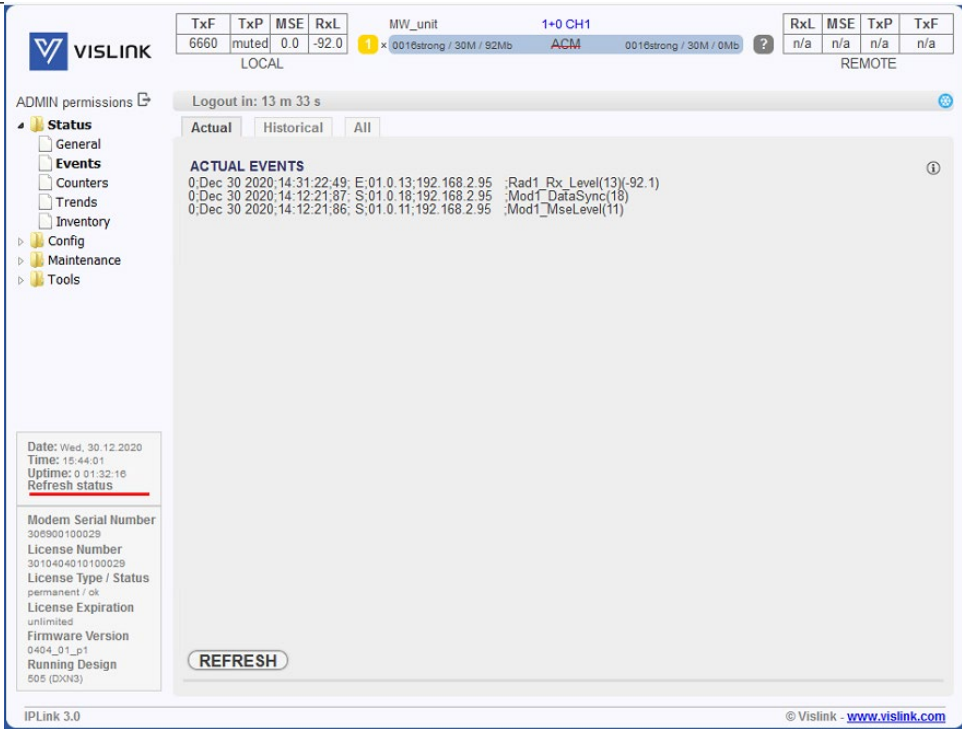

The screenshot shows the Vislink IPLink 3.0 interface. At the top, there are status indicators for TxP (6660), MSE (muted), RxL (0.0), and MW\_unit (1+0 CH1). Below this, there are tabs for LOCAL and REMOTE. The left sidebar shows a tree view with 'Status' expanded, containing 'General', 'Events', 'Counters', 'Trends', and 'Inventory'. The main content area is titled 'ACTUAL EVENTS' and contains three entries:

```

0:Dec 30 2020:14:31:22:49; E:01.0.13;192.168.2.95 ;Rad1_Rx_Level(13):-92.1
0:Dec 30 2020:14:12:21:87; S:01.0.18;192.168.2.95 ;Mod1_DataSync(18)
0:Dec 30 2020:14:12:21:86; S:01.0.11;192.168.2.95 ;Mod1_MseLevel(11)
  
```

At the bottom of the event list, there is a 'REFRESH' button. The interface also shows system information like 'Date: Wed, 30.12.2020', 'Time: 15:44:01', and 'Uptime: 0 01:32:16'. The footer includes 'IPLink 3.0' and '© Vislink - www.vislink.com'.

Figure 6-7 Actual Tab

Actual – The list of alarms which are active at the particular moment. Under standard circumstances should be empty

### 6.4.2. Historical Tab

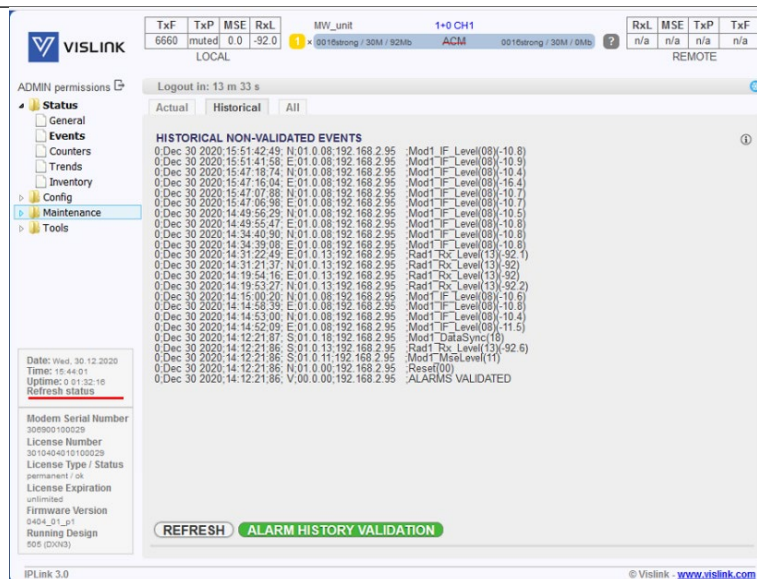

Figure 6-8 Historical Tab

Historical – The same as Actual for alarms which occurred in the past but which are no longer active. Moreover, an extra button **ALARM HISTORY VALIDATION** will be shown. By pressing this button you are letting the unit to know that you have reviewed such historical alarm so the status of the device will be evaluated only from alarms which occurred after the manual validation.

### 6.4.3. All Tab

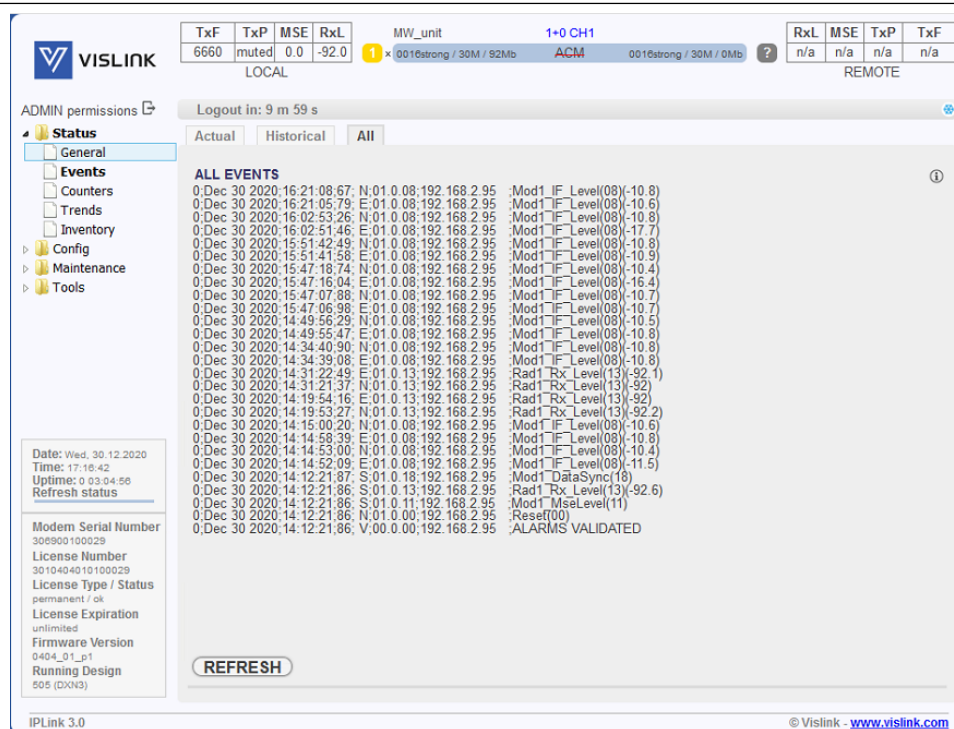

Figure 6-9 All Tab

All – The conjunction of both Actual and Historical alarms. Moreover an extra button CLEAR ALL ALARMS will be shown. By pressing this button you can erase all active and historical alarms.

## 6.5. Counters Page

### 6.5.1. Modem Tab

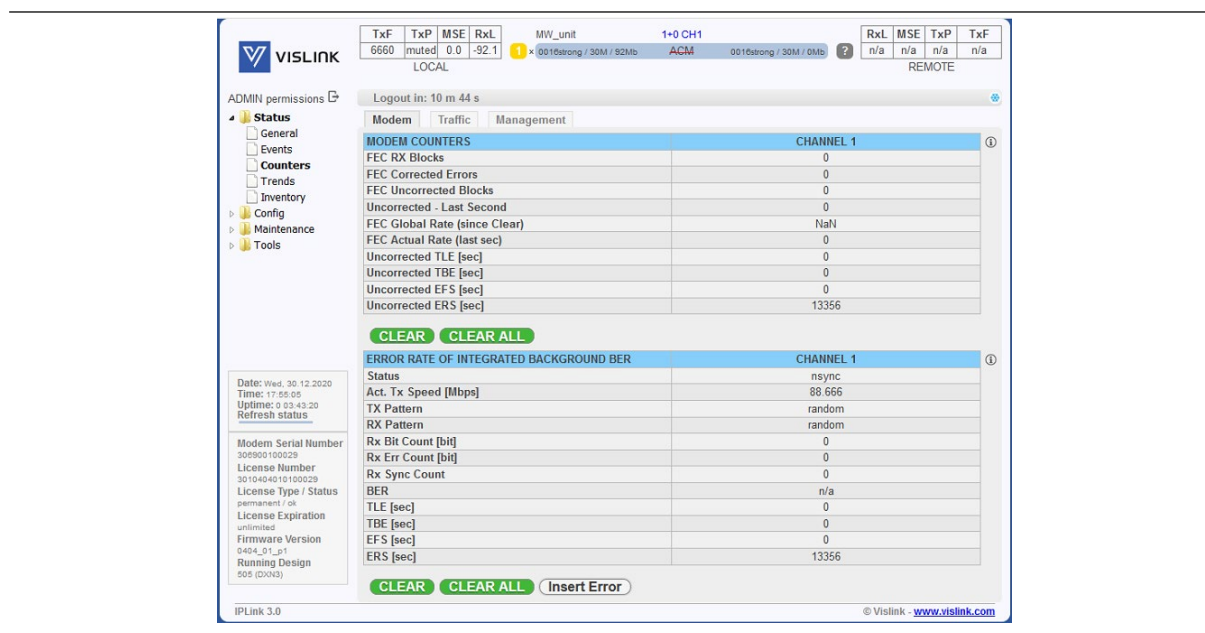

Figure 6-10 Modem Tab

## MODEM COUNTERS -

### Basic counters frame

- FEC RX Blocks – the overall number of received Reed Solomon blocks
- FEC Corrected Errors – the number of errors which were repaired by FEC (Forward Error Correction)
- FEC Uncorrected Blocks – the number of Reed Solomon blocks which could not be repaired by FEC. This number represents a fragment of the FEC RX Blocks
- Uncorrected - Last Second – the number of air-frames which could not be repaired during the last second
- FEC Global Rate – the ratio of FEC Uncorrected Errors / FEC RX Blocks
- FEC Actual Rate – same as above but for latest second only
- Uncorrected TLE – time since last error; a number of seconds from the last error occurrence. It should correspond to the time since pressing the CLEAR button
- Uncorrected TBE – time between last two error events
- Uncorrected EFS – error free seconds; it should correspond to time since pressing the CLEAR button
- Uncorrected ERS – error seconds; number of seconds during which errors occurred

By pressing the CLEAR button, the values of counters will be erased. By pressing the CLEAR ALL button, the values of counters **on all Counter pages** will be erased.

#### ERROR RATE OF INTEGRATED BACKGROUND BER -

Built-in Bit Error Rate counters frame. Please note that only unassigned capacity will be used for BER tester (See *Config/Ports/MUX* page).

- Status – BER tester synchronization status (sync|nosync) or n/a when there is no active link to the remote side or free capacity left for the BER tester
- Actual Tx Speed – shows reserved transmission speed for BER tester. This value roughly equals to half of the unassigned capacity which is used for the BER tester
- TX Pattern – shows transmission pattern for BER tester frames
- RX Pattern – shows receiving pattern of BER tester frames
- Rx Bit Count – shows number of received bits (BER)
- RX Err Count – shows number of received error bits (BER)
- Rx Sync Count – number of synchronizations of the BER tester
- BER – ratio of Rx Bit Count and Rx Err Count
- TLE – time since last BER error; a number of seconds from the last error occurrence. It should correspond to time since pressing the CLEAR button
- TBE – time between the last two BER error events
- EFS – error free seconds of the BER tester; it should correspond to time since pressing the CLEAR button
- ERS – error seconds; number of seconds during which a BER error occurred

By pressing the CLEAR button, the values of BER counters will be erased. By pressing the CLEAR ALL button, the values of counters **on all Counter pages** will be erased.

By pressing the Insert Error button, one error will be inserted into data streams of both modems.

### 6.5.2. Traffic Tab



Figure 6-11 Traffic Tab

#### Traffic Tab -

This page provides a detailed overview of data frames flow. The frame consists of the LAN COUNTERS which are captured by the device’s switch and the FPGA COUNTERS which are captured by the modem.

By pressing the CLEAR button, the values of counters will be erased. By pressing the CLEAR ALL button, the values of counters **on all Counter pages** will be erased.



### 6.5.3. Management Tab

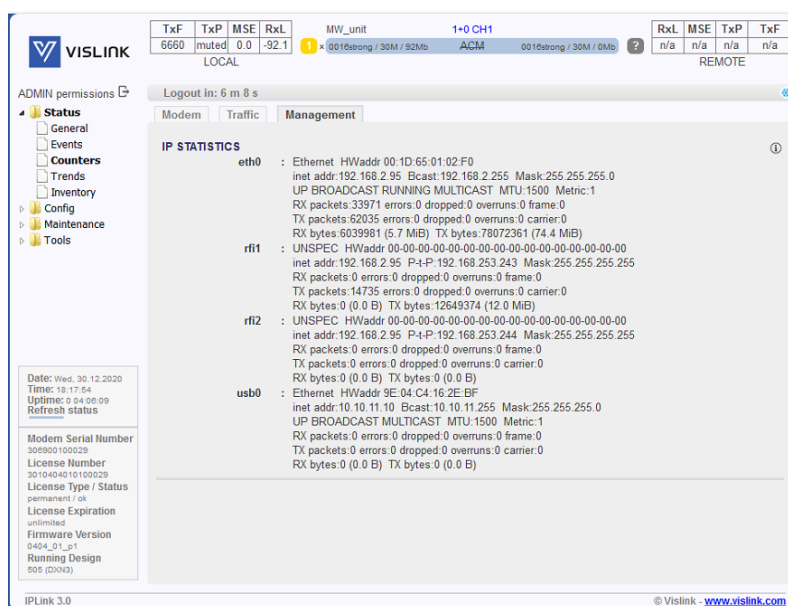

Figure 6-12 Management Tab

#### Management Tab -

This frame provides IP statistics of device's interfaces:

- eth0 – Ethernet port of MNG CPU with its own MAC address and all the standard features of Ethernet interface. Device/Fallback addresses and appropriate subnet masks are assigned to this interface.
- Rfi1/2 – ppp (point-to-point protocol) type of interface which interconnects local MNG CPU with the remote side MNG CPU accessible through the separate channel inside air-frame
- usb0 – an onboard service USB port which is dedicated to local service IP access



## 6.6. Trends Page

### 6.6.1. Actual Tab

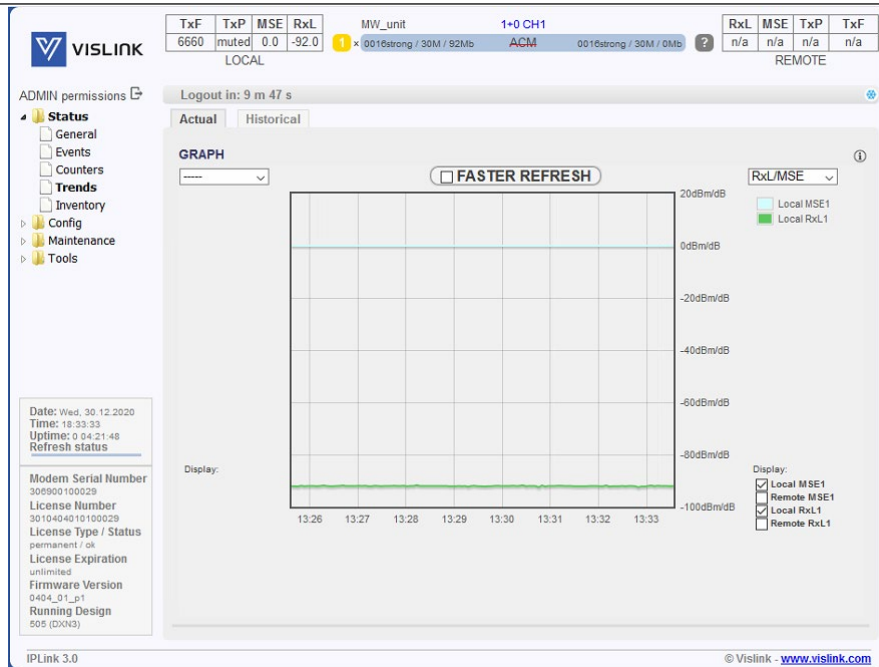

Figure 6-13 Actual Tab

Actual -

The graph displays the selected values in dependence on time. If the connection with remote is established, the values from the remote unit are also displayed. This graph is dynamic and thus updated with newest values with each GUI auto-refresh. You can decrease the pooling period to 1/2 of normal refresh interval by means of the FASTER REFRESH button. Please note that it can take up to several seconds before the faster refresh is activated. Also, note that every such refresh will cause zoom reset. The normal refresh interval is computed dynamically from server response time. The actual interval is displayed in the browser console.

For depiction it is possible to choose from following options:

- TxPower – depicts the transmitted level of signal output
- RxL/MSE – received level of the signal output/quality of the received signal
- Temperature – displays the temperature of modem and radio

Please note that resolution of the displayed data will be lower for older records and higher for the newest. This time segmentation is 10 minutes, 1 minute and 1 second.

## 6.6.2. Historical Tab

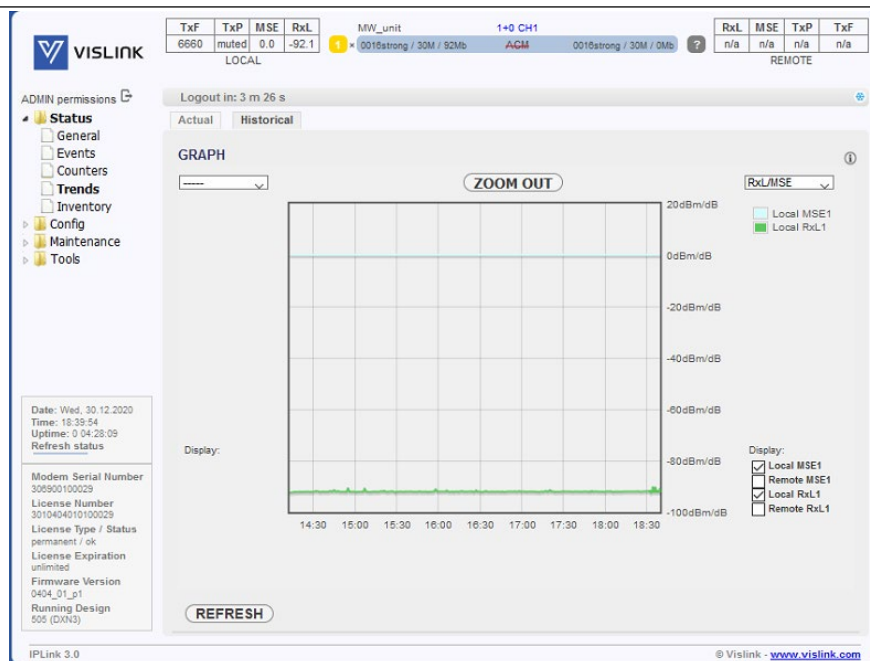

Figure 6-14 Historical Tab

The graph displays the selected values in dependence on time. If the connection with remote is established, the values from the remote unit are also displayed.

For depiction it is possible to choose from following options:

- TxPower – depicts the transmitted level of signal output
- RxL/MSE – received level of the signal output/quality of the received signal
- Temperature – displays the temperature of modem and radio
- ETH\_Count – displays the transmission capacity for transmission and admission on the selected ports of the device
- Sync/Modul – value MLOCK = 1 displays modem synchronization, value MLOCK = 0 shows that there was no synchronization. If ACM is active, the most appropriate modulation for signal transmission or admission is found. Individual modulations are indicated by their amount of states

You can zoom the graph by means of mouse selection of the range of interest and reset the zoom by pressing the ZOOM OUT button.

Please note that resolution of the displayed data will be lower for older records and higher for the newest. This time segmentation is 10 minutes, 1 minute and 1 second.

## 6.7. Inventory Page

### 6.7.1. Inventory Tab

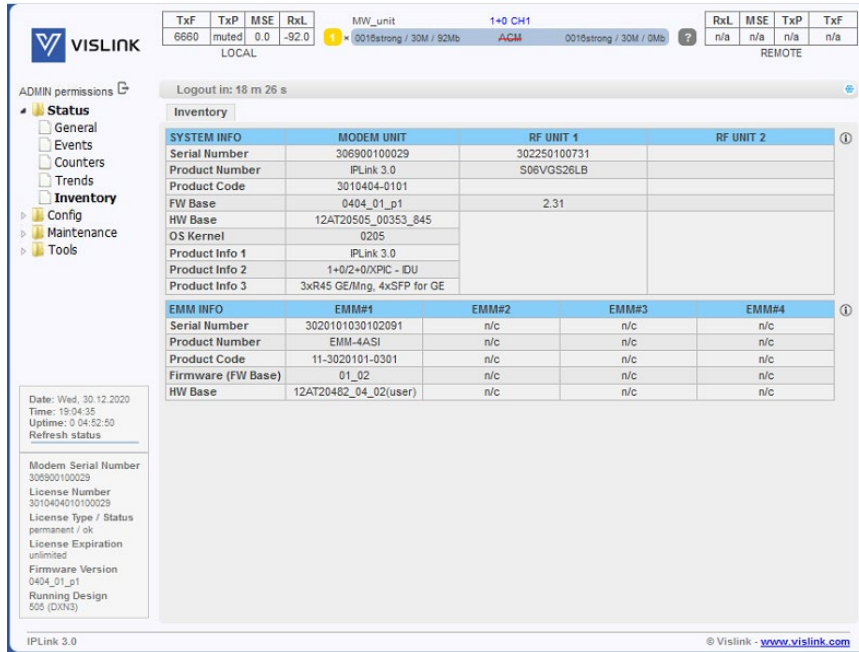

The screenshot displays the Vislink web interface for the Inventory tab. The top navigation bar shows 'TxP muted', 'MSE 0.0', and 'RxL -92.0'. The main content area is divided into two sections: 'SYSTEM INFO' and 'EMM INFO'. The 'SYSTEM INFO' table lists details for the modem unit and two radio frequency units. The 'EMM INFO' table lists details for four EMMs. A sidebar on the left contains navigation options like 'Status', 'Config', and 'Tools'. A status box on the bottom left shows system metrics like date, time, and uptime.

SYSTEM INFO		MODEM UNIT	RF UNIT 1	RF UNIT 2
Serial Number	306900100029		302250100731	
Product Number	IPLink 3.0		S06VGS26LB	
Product Code	3010404-0101			
FW Base	0404_01_p1		2.31	
HW Base	12AT20505_00353_845			
OS Kernel	0205			
Product Info 1	IPLink 3.0			
Product Info 2	1+0/2+0/XPIC - IDU			
Product Info 3	3xR45 GE/Mng, 4xSFP for GE			

EMM INFO		EMM#1	EMM#2	EMM#3	EMM#4
Serial Number	3020101030102091	n/c	n/c	n/c	n/c
Product Number	EMM-4ASI	n/c	n/c	n/c	n/c
Product Code	11-3020101-0301	n/c	n/c	n/c	n/c
Firmware (FW Base)	01_02	n/c	n/c	n/c	n/c
HW Base	12AT20482_04_02(user)	n/c	n/c	n/c	n/c

Figure 6-15 Inventory Tab

#### SYSTEM INFO –

This frame shows the device information as well as radio part information.

#### EMM INFO –

This frame shows the EMM inventory information.

## 6.8. System Page

### 6.8.1. Mode Tab

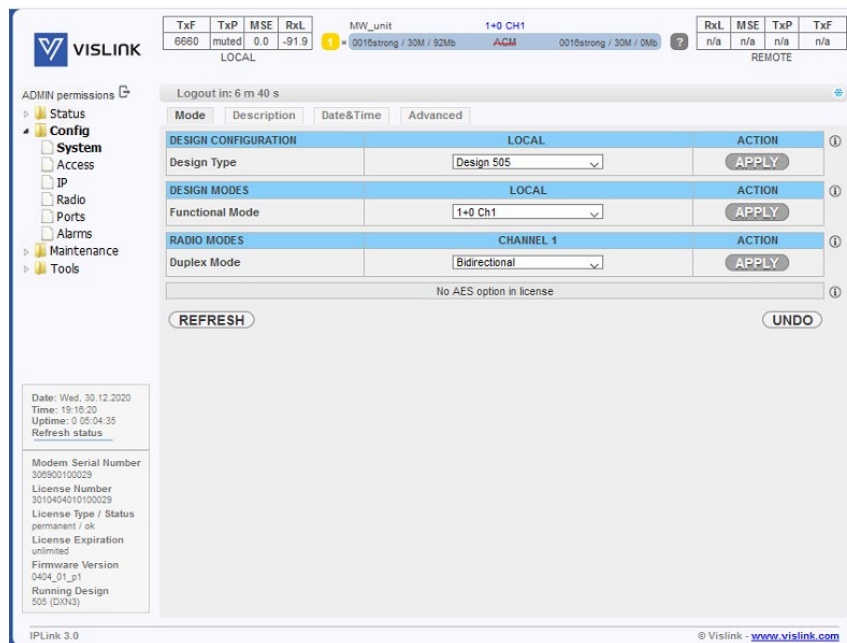

Figure 6-16 Mode Tab

#### DESIGN CONFIGURATION -

Depending on the content of the license file, the user can select specific Design Type which completely changes the system function. At the moment there are two designs available:

- Design 505 – A single mount device on each side of the link. Available modes are 1+0 (ch1, ch2, dual FD and dual XPIC), 1+1 (FD, HSB/SD, SD, XPIC) and 2+0 (FD, XPIC). This design supports AES encryption if licensed.
- Design 511 – Two or more devices on each side of the link.
- This design type should be selected for application where extended protection is required. Two or more interconnected IDUs are used on each side of a link in this configuration.
- At the moment there is only Split 1+1 (FD, HSB/SD, SD) mode available. Please note that the AES encryption is not available in this design.

#### Important notes:

- The design change will load a configuration presets for given design. That means the device should be re-configured by the user after such change accordingly. It is recommended to reboot the device after such re-configuration.
- The link to the remote side will be lost. Please ensure you have local access to all devices before such change. The remote device has to be configured accordingly by the user.

## DESIGN MODES -

Selection of the desired mode. The content of this menu depends on available system modes defined in the device license.

Please note that it is recommended to save the configuration and reboot the device after Mode change.

The available modes are:

- Functional Mode – above mentioned Radio modes can be combined with following Functional modes:
- 1+0 Ch1/2 – simple one channel end station which uses physical channel Nr.1/2
- 1+0 Dual – advanced 1+0 mode which separately uses both physical channels
- 2+0 Dual – capacity aggregation mode which combines the capacity of both physical channels. This Mode supports following **Link Diversity** Modes:
- FD – frequency diversity configuration with frequency separation in both physical channels of the device
- XPIC – cross-polarization diversity with automatic attenuation of interfering signal from the X-polarized channel
- 1+0 Star – the mode where is the Channel 1 directed to the West remote and Channel 2 to the East remote device
- 1+1 Dual – capacity aggregation mode which combines the capacity of both physical channels. This Mode supports following **Link Diversity** Modes:
- FD – frequency diversity configuration with frequency separation in both physical channels of the device
- SD – space diversity configuration with single Tx channel, two Rx channels and two antennas in both directions
- HSB/SD – hot standby configuration with single Tx channel at a time and two Rx channels in both directions
- XPIC – cross-polarization diversity with automatic attenuation of interfering signal from the X-polarized channel

## RADIO MODES -

The duplex radio mode settings. This setting determinates the duplex/simplex function of the configured link and has an essential influence on whole system function. The available options depend on the license file. The available modes are:

- Rx Only – half-duplex/simplex link with only Rx channel. Note the automatic ACM function should be set to the manual profile by the user.
- Tx Only – half-duplex/simplex link with Tx only channel. Note the automatic ACM function should be set to the manual profile by the user.
- Bidirectional – full duplex link with Tx and Rx channels

Please note that the simplex configuration limits the device functionality considerably. The ACM function will not work as well as remote side monitoring from Tx only side, etc.

## AES ENCRYPTION (license required)-

This frame contains AES settings. Please note that the AES function will not be available if it is not included in the license. Also, note that the settings may be available for one or two channels depending on the configuration of the *Functional Mode*.

- AES key length – One of two ASI key lengths can be selected for the AES encryption: 32 hex digits key (128 bits) or 64 hex digit key (256 bits). If there is no specific requirement of 128-bit key usage the 256-bit key is recommended as it has not a negative performance effect in comparison to a 128-bit key.
- AES key input – A 32 hex digit key (128 bits) or 2x 32 hex digit keys (256 bits) must be entered for each channel in order to properly initialize the AES function. The same key must be entered on local and remote channels. You can use the GENERATE KEYS button to generate a random key(s).
- AES key status – This information line shows the status of the actual AES key, as well as CRC of entered valid key. Note that such CRC value MUST match on both local and remote respective channels.
- AES function – This box enables or disables AES encryption function. When enabled, the whole traffic stream from packet processor is encrypted by provided AES key. Out of band management channel is not encrypted in this mode, therefore remote access to remote IDU is possible in any way. You have to define valid AES key(s) in order to enable the AES function. If you copy AES key to input, you must have this input blank.

### 6.8.2. Description Tab

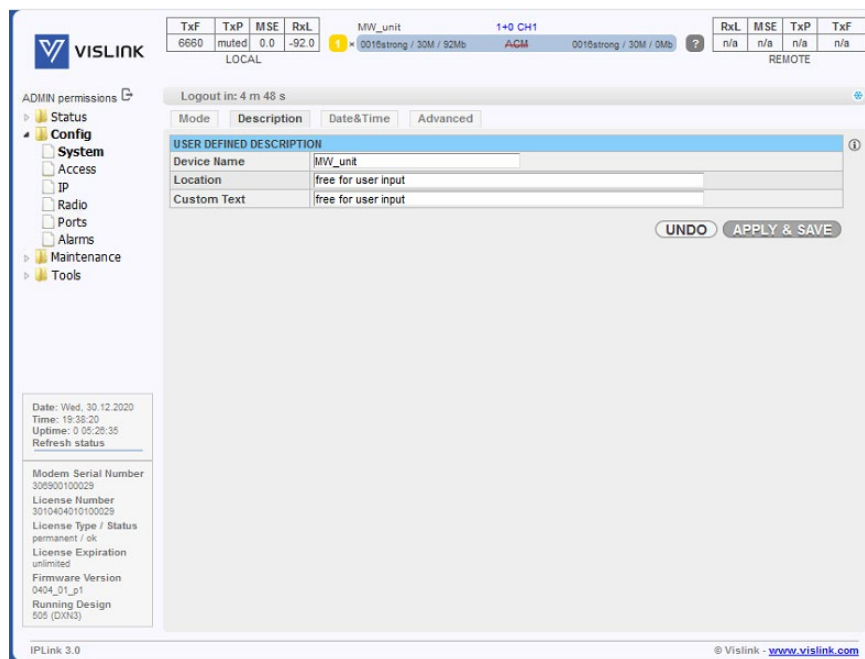

Figure 6-17 Description Tab

## USER DEFINED DESCRIPTION-

The info frame serves number of optional user-defined description fields:

- Device Name – the device name shown in the header/web page title
- Location – location of device

- Custom Text – free field for user input

Valid characters are [a-zA-Z0-9\_!@#%()-+=;.,?/] (including [] and without space character in device name)

### 6.8.3. Date & Time Tab

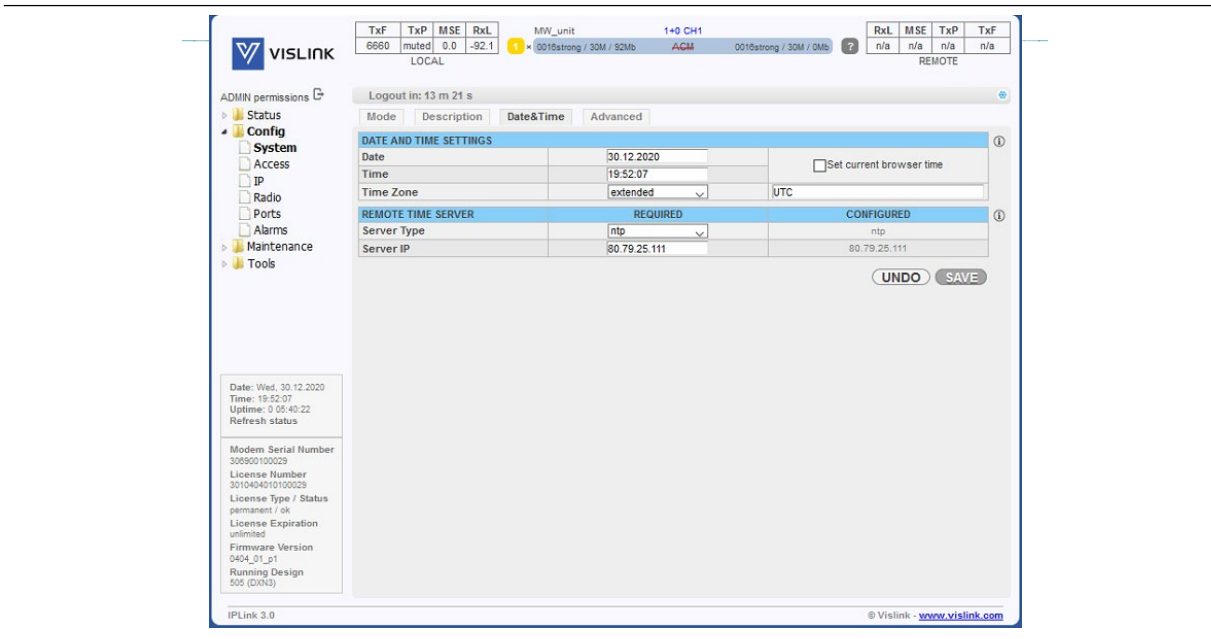

Figure 6-18 Data & Time Tab

#### DATE AND TIME SETTINGS –

The frame with date, time and time zone settings. Please note that the date and time settings may not be available if a time limited license is in use.

**Important:** Please note that Date/Time change will cause an automatic logout of the WEB GUI.

#### REMOTE TIME SERVER -

Network time protocol / rdate protocol settings. When you select ntpds value, the device will be used as local NTP server. The NTP synchronization is directed by the protocol itself while the rdate synchronization is initialized once per 24 hours and during startup of the device.

## 6.8.4. Advanced Tab

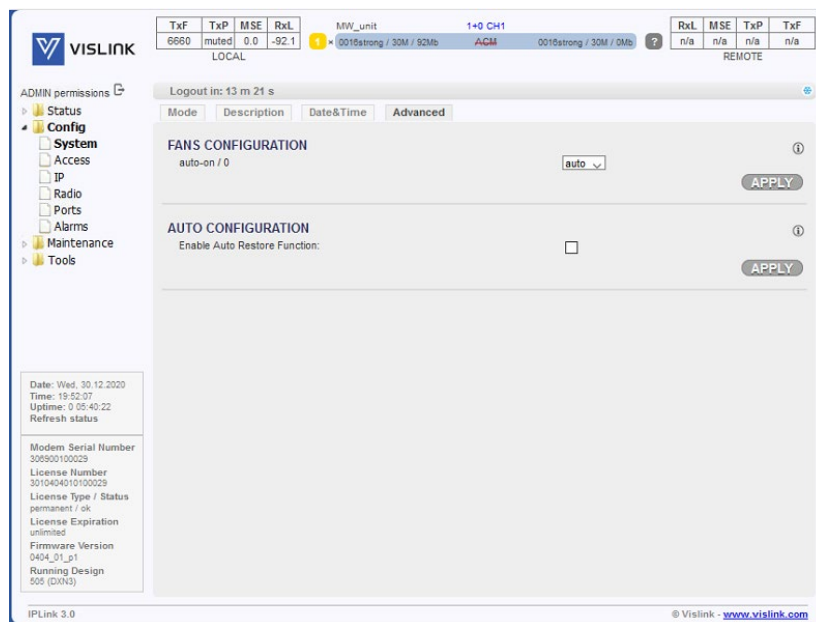

Figure 6-19 Advanced Tab

### FANS CONFIGURATION -

The configuration of the inbuilt ventilator. Options are following:

- on – ventilator always on
- off – ventilator always off
- auto – ventilator is autoregulated by the device (default)

The thresholds for auto mode are  $\geq 40^{\circ}\text{C}$  to turn the ventilator on,  $\leq 30^{\circ}\text{C}$  to turn the ventilator off.

### AUTO CONFIGURATION -

When enabled, the stored start-up configuration (c0) executes on local device after 10 minutes of continuous errors on active radio channels. This function does not run when at least one radio channel works. The recommendation is to disable this function during the initial link configuration and in the protection modes. By default, it is off.



## 6.9. Access Page

### 6.9.1. Users Tab

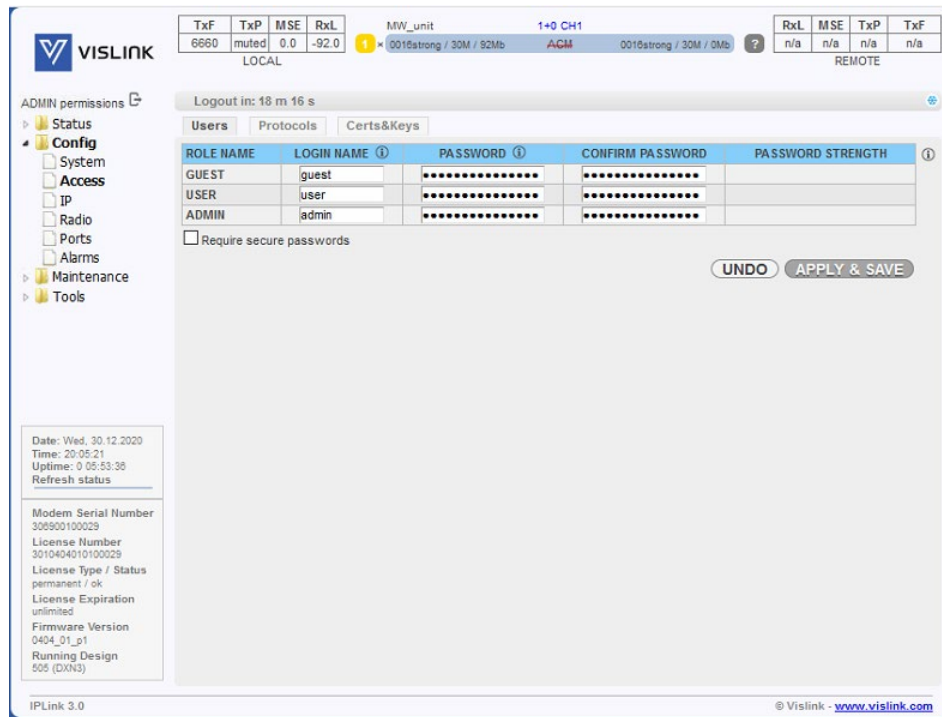

Figure 6-20 Users Tab

#### Usernames and passwords settings frame

- ROLE NAME – level of the access rights
- GUEST – read-only access
- USER – standard management access
- ADMIN – enhanced management access - enhanced settings, passwords, FW upgrade, etc.
- 
- Require secure passwords – only secure passwords will be accepted.
- - Secure password – is 8 or more characters long, contains lowercase, uppercase and numbers. More secure password consists of at least 13 characters and contains combination of lower/uppercase characters, numbers and symbols ( ! @ # % ( ) \_ - + = [ ] : , . ? / ). Please do not use other characters ( ^ & \$ { } \ | ).
- LOGIN NAME – user name for selected level of the access The number of characters in the input field have to be in range from 4 to 12. Valid characters are [a-z, A-Z, 0-9, \_]. You can not use user names already present in system (root, daemon, username present in other access level...).
- PASSWORD – password for selected level of the access. The number of characters in the input field have to be in range from 0 to 19. Password for ADMIN have to be in range from 1 to 19.
- CONFIRM PASSWORD – has to be the same as *PASSWORD*.

## 6.9.2. Protocols Tab

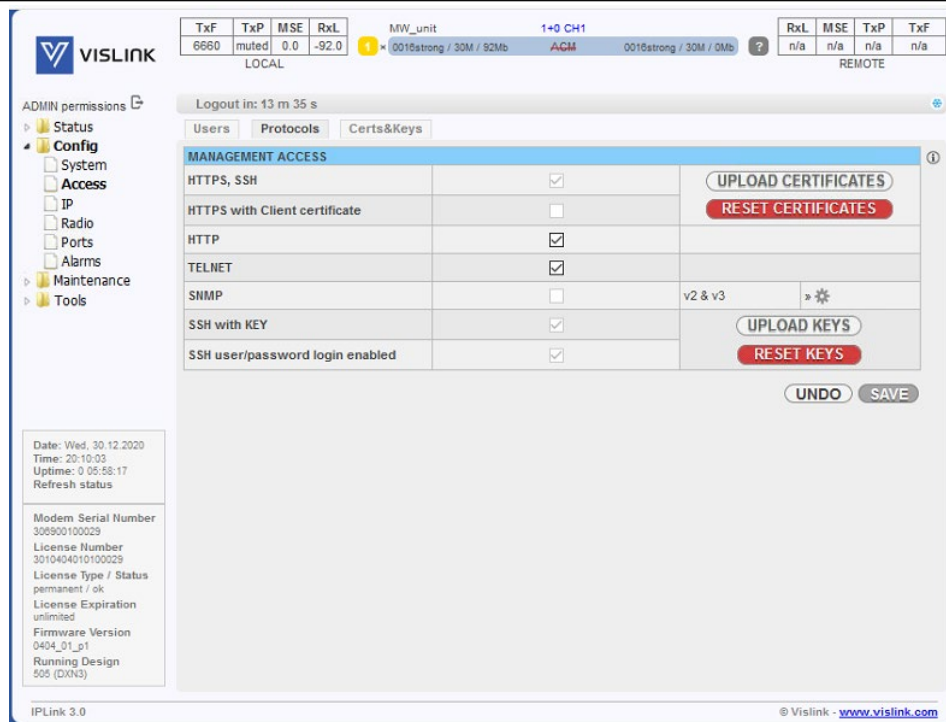

Figure 6-21 Protocols Tab

### MANAGEMENT ACCESS -

#### Management protocols and security configuration

- HTTPS, SSH – still on – cannot be turned off.  
By default, self-signed SC is used. This causes a browser security warning. To avoid this warning you can upload your own server certificate (SC) and upload the appropriate client certificate (CC) to the user browser.
- HTTPS with Client Certificate – https access is possible only if the client (browser) has installed client certificate (CC). The option is available only if the device has uploaded the CA certificate signing CC. Reset of the CA certificate is possible only if this option is not checked.
- HTTP, TELNET, SNMP – to increase the security of the device you can disable unencrypted access (http, telnet, SNMP v2) and turn on only encrypted SSH, HTTPS and SNMP v3 (SNMP can be set only on the Config/IP/SNMP page).
- SSH with KEY – You can provide SSH keys in order to log in via SSH terminal without using a password.
- SSH user/password login enabled – You can switch off SSH login using username/password. You have to be sure that login without password works! Reset of the SSH key is possible only if this option is enabled.

### 6.9.3. Certs&Keys Tab

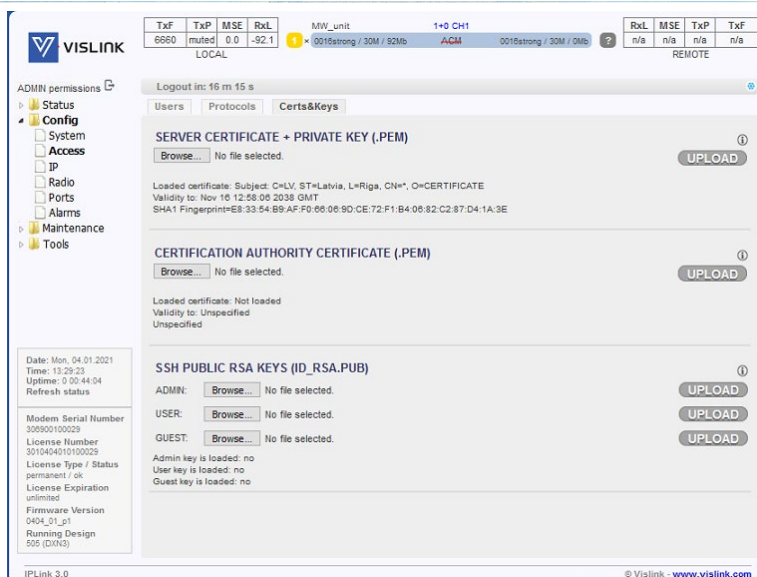

Figure 6-22 Certs&Key Tab

#### SERVER CERTIFICATE + PRIVATE KEY (.PEM) -

A tool for HTTPS server certificate import. Below the frame is shown basic information of actual HTTPS certificate. By default, a self-signed certificate is loaded. It causes a browser security alert.

#### CERTIFICATION AUTHORITY CERTIFICATE (.PEM) –

You can secure your access by means of a personal certificate loaded in your browser. In this frame, you can import a Certification Authority who signed your personal certificate. Below the frame is shown basic information about actual authority certificate.

#### SSH PUBLIC RSA KEYS (ID\_RSA.PUB) -

You can secure your SSH connection by means of importing your own public SSH key. It is usually stored in your home directory as `./ssh/id_rsa.pub`.

Attention! The other file `"id_rsa"` (without extension) stored in the same directory is your PRIVATE key! It must not leave your home directory and/or computer!

You can load a key for each user role. Statuses are shown in the frame below.

## 6.10. IP Page

### 6.10.1. Addresses Tab

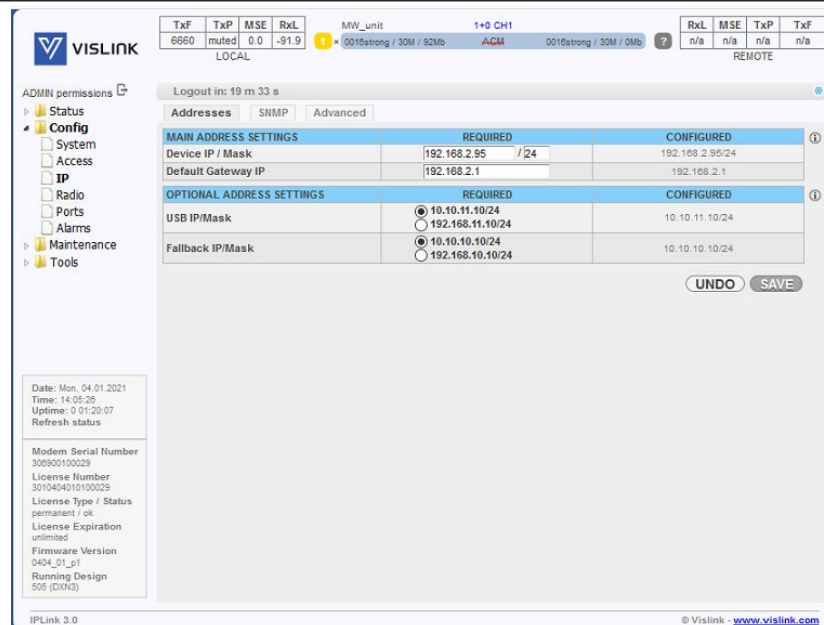

Figure 6-23 Addresses Tab

#### MAIN ADDRESS SETTINGS -

Every device in the local network has its own and unique primary IP address. Thanks to this IP address it is possible to access each equipment in your network. While setting up the IP address, pay attention to the configuration which needs to follow general IP addressing rules (IP address, IP netmask, IP gateway). The customer has to ensure that correct IP addresses are assigned and configured for all units in the microwave network.

The description of particular setting and display boxes:

- Device IP / Mask – IP address assigned to port ETH0 (device local address) with the appropriate netmask specification. Netmask value is inserted in form of a decimal number which corresponds to numbers in binary subnet mask presentation. Such net-mask for subnet mask 255.255.255.0 is presented as decimal number 24. Local network has its own and unique primary IP address.
- Default Gateway IP – default Gateway IP address is used by CPU when connection outside of IP range defined in system routing table is required. Such IP address must be a member of the above defined Device IP subnet.

This frame shows the REQUIRED and CONFIGURED IP settings. REQUIRED settings will be stored by the SAVE button. In order to activate the new setting please use the IP INIT button (you will be logged out, but user traffic will not be dropped) or WRITE the settings and reboot the device.

## OPTIONAL ADDRESS SETTINGS -

- USB IP/Mask – it specifies IP address for USB0 management port. When default USB IP address is in collision with other network configuration it can be changed with this parameter. Factory default value is 10.10.11.10/24
- Fallback IP/Mask – it specifies fallback IP address for ETH0 management port. When default fallback IP address is in collision with other network configuration it can be changed with this parameter. Factory default value is 10.10.10.10/2

### 6.10.2. SNMP Tab

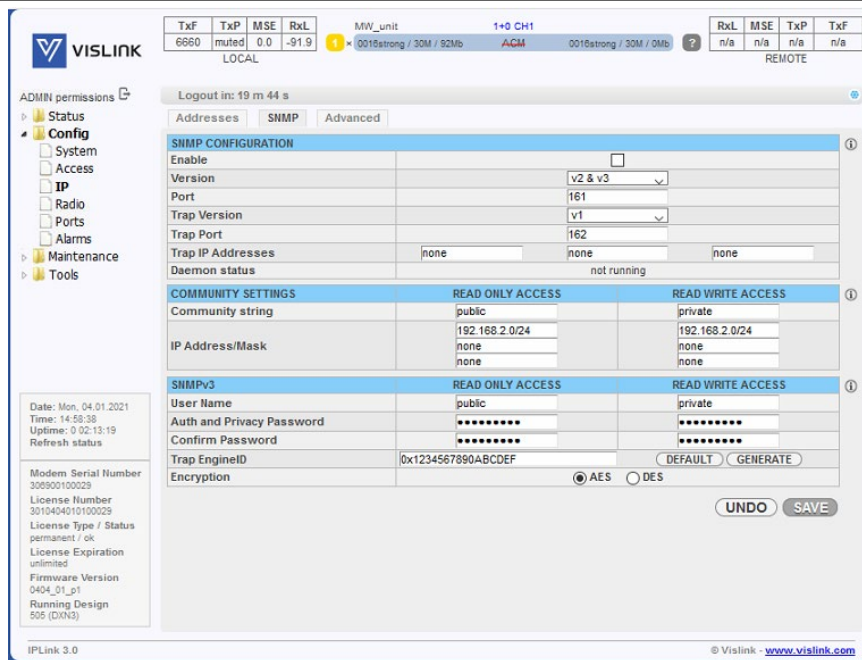

The screenshot shows the Vislink web interface for the SNMP tab. The interface is divided into several sections:

- Navigation Menu:** Includes Status, Config (System, Access, IP, Radio, Ports, Alarms), Maintenance, and Tools.
- Status Bar:** Shows system information like TxP, MSE, RxL, MW\_unit, and CH1.
- SNMP CONFIGURATION:**
  - Enable:
  - Version: v2 & v3
  - Port: 161
  - Trap Version: v1
  - Trap Port: 162
  - Trap IP Addresses: none, none, none
  - Daemon status: not running
- COMMUNITY SETTINGS:**

	READ ONLY ACCESS	READ WRITE ACCESS
Community string	public	private
IP Address/Mask	192.168.2.0/24	192.168.2.0/24
	none	none
	none	none
- SNMPv3:**

	READ ONLY ACCESS	READ WRITE ACCESS
User Name	public	private
Auth and Privacy Password	*****	*****
Confirm Password	*****	*****
Trap EngineID	0x1234567890ABCDEF	
Encryption	<input checked="" type="radio"/> AES <input type="radio"/> DES	

Figure 6-24 SNMP Tab

## SNMP CONFIGURATION -

This window provides the configuration options of the inbuilt SNMP server:

- Enable – this check box enables the SNMP daemon in the device
- Version – SNMP v2c or SNMP v3 can be used for SNMP access to device
- Port – the parameter specifies which port will be used for SNMP communication. The same configuration must be set also in SNMP agent station
- Trap Version – specifies which SNMP trap version should be used for traps
- Trap Port – the parameter specifies the destination port on which SNMP traps will be sent to. The same configuration must be set also in SNMP agent station

Issue: No.

45

- Trap Address 1-3 – up to three IP addresses can be configured as the destination for SNMP trap distribution. Trap message events are configured in the same way as the alarm setting. Note the SNMP v3 traps can be sent to only one address
- Daemon status – the current status reported by the SNMP daemon

## COMMUNITY SETTINGS -

These settings are required only for the SNMPv2 protocol. For SNMPv3 has no effect.

- Community string – the parameter specifies community string for secure SNMP management access (a different setting for read-only and read/write access can be entered, valid for SNMP v2). The number of characters in the input field has to be in the range from 1 to 15. Valid characters are [a-z, A-Z, 0-9, \_]
- IP Address/Mask – up to three IP subnets can be configured as permitted IP source for SNMP management access. Please note that the Mask parameter is mandatory.

## SNMPv3 -

These settings are required only for the SNMPv3 protocol. For SNMPv2 has no effect.

- User Name – username configuration for secure SNMP access with SNMP v3 protocol (a different setting for read-only and read/write access can be entered). The number of characters in the input field has to be in the range from 4 to 15. Valid characters are [a-z, A-Z, 0-9, \_]
- Auth and Privacy Password – password configuration for secure SNMP access with SNMP v3 protocol, the identical password must be entered into Confirm Password box (a different setting for read only and read/write access can be entered). The number of characters in the input field has to be in the range from 8 to 15. Valid characters are [a-z, A-Z, 0-9, \_]
- Trap EngineID – the SNMP v3 Trap EngineID of generated SNMP v3 traps. The same EngineID must be set in the receiving agent. This hexadecimal number is automatically prefixed with the required '0x'. The allowed characters are [A-F, 0-9]. The number must not begin with 0 or be assembled only with 'F' values and has to be between 12 and 26 characters long including the prefix. Note the other SNMP v3 trap parameters are inherited off the READ ONLY ACCESS settings. Example: *0x123456789ABCDEF*
- - Default – this will fill in the MAC address of the device. Possible '0' at the beginning of the string will be replaced with 'F'
- - Generate – this will fill in a random valid hexadecimal number of length ranging between 12-14 characters including prefix
- Encryption – the encryption protocol for the SNMPv3
- - CFB-AES-128
- - CBC-DES

### 6.10.3. Advanced Tab

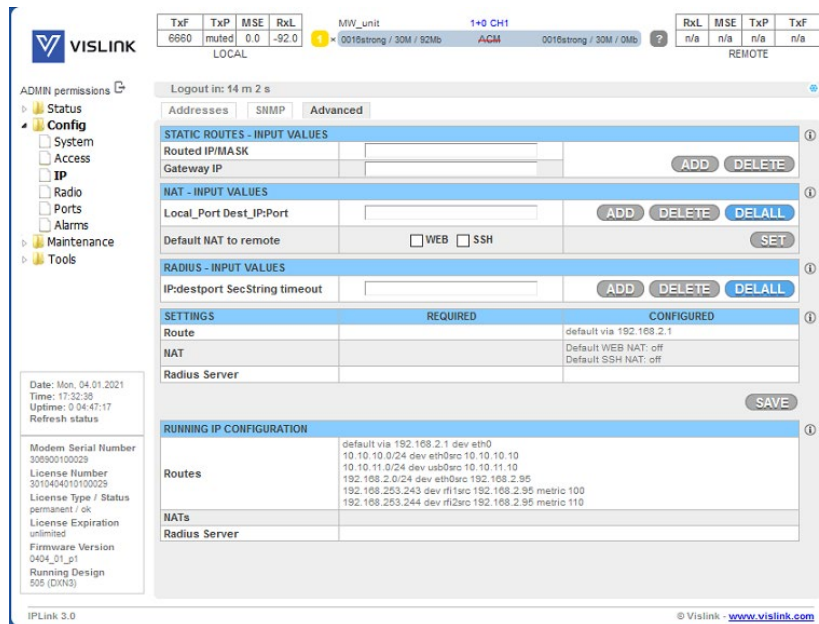

Figure 6-25 Advanced Tab

#### STATIC ROUTES – INPUT VALUES –

For a specific configuration of management access, it is sometimes necessary to add or delete static routes.

You can DELETE an already specified route by simply specifying it in the *Routed IP/MASK*. It is not necessary to specify the *Gateway IP* for route deletion.

Please remember to store the new configuration using the SAVE button and to re-initialise the configuration using the IP INIT button.

- Routed IP / MASK – IP address from the routed network and the appropriate network mask must be inserted. Routed network range is calculated from inserted values.
- Gateway IP – the correct IP address gateway for above-mentioned network must be inserted.

#### NAT – INPUT VALUES –

For a specific configuration of management access, it is sometimes necessary to add or delete NAT records. This is especially required for Out of band type of management access.

- LocalPort DestIP:Port – the NAT record must be inserted in the following format: local\_port destination\_ip:port (example: '10443 192.168.1.2:443' => local port 10443 redirects to the port 443 (secure web - https) of the unit with IP 192.168.1.2)
- Default NAT to remote – By this settings you can enable or disable the automatically generated NAT records for WEB and SSH management access. Please note that these records will work only when there is active connection between this and the targetted device.



- WEB  
This will add automatic NAT record for accessing the remote device's WEB GUI. The default values follows (the IP portion is only example and depends on actual running IP configuration):
- 1443 192.168.3.91:443 - Remote device's GUI accessible on local port 1443 (e.g. https://localIP:1443)
- 2443 192.168.3.92:443 - Second Remote (in *Star* mode) or direct FO neighbour (in *Split Protection* mode) device's GUI accessible on local port 2443
- 3443 192.168.3.93:443 - Indirect Remote FO neighbour (ergo 'cross-corner' in *split protection* mode) device's GUI accessible on local port 3443
- SSH  
This will add automatic NAT record for accessing the remote device's SSH . The default values follows (the IP portion is only example and depends on actual running IP configuration):
- 1022 192.168.3.91:22 - Remote device's GUI accessible on local port 1022
- 2022 192.168.3.92:22 - Second Remote (in *Star* mode) or direct FO neighbour (in *Split Protection* mode) device's GUI accessible on local port 2022
- 3022 192.168.3.93:22 - Indirect Remote FO neighbour (ergo 'cross-corner' in *split protection* mode) device's GUI accessible on local port 3022

## RADIUS – INPUT VALUES –

### Radius access configuration

- IP:destport SecString timeout – the definition of remote Radius server
- - IP – IP address of the Radius server
- - destport – Destination port
- - secString – password of Radius Server login. The recommended length of the password is from 4 to 50 characters
- - timeout – connection time-out between the device and Radius Server. Recommended value is 1 – 5 second

## SETTINGS –

This frame informs the user about the REQUIRED and CONFIGURED IP settings. REQUIRED settings will be stored by means of the SAVE button. In order to activate the new setting please use the SAVE & IP INIT button (you will be logged out, but data will not be dropped) or SAVE the IP settings and reboot the device.

## RUNNING IP CONFIGURATION –

This frame shows the device's active IP Route table, NAT records and Radius Server configuration.

In order to populate this table with a new configuration, you have to re-initialize the IP configuration by means of IP INIT button.



## 6.11. Radio Page

### 6.11.1. Parameters Tab

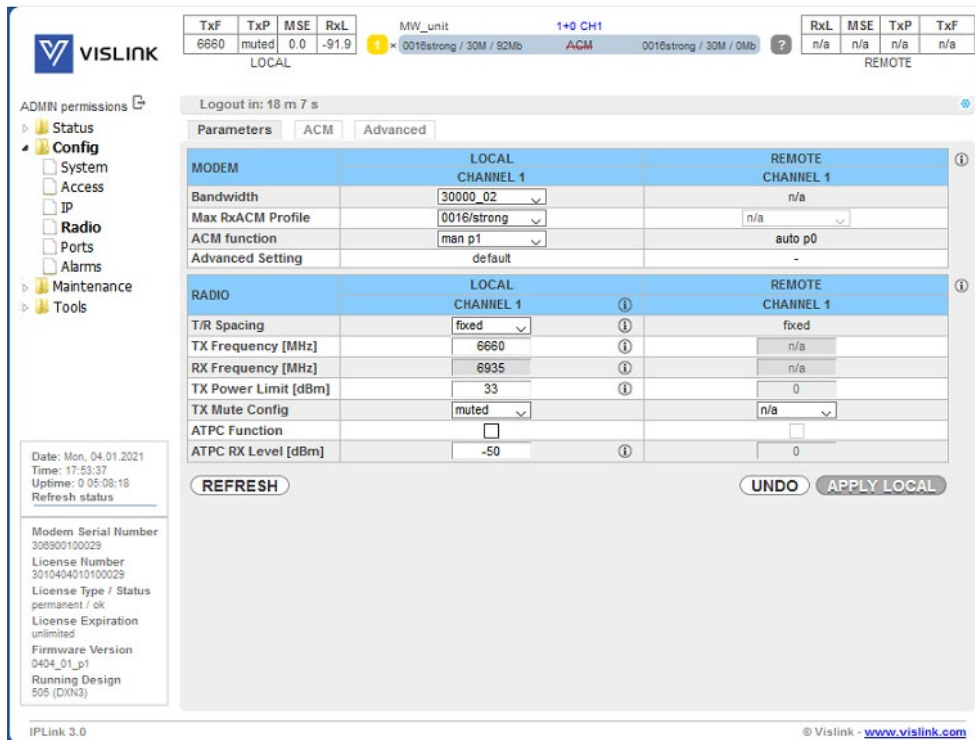

The screenshot shows the Vislink Parameters Tab interface. At the top, there are status indicators for TxP (muted), MSE (0.0), and RxL (-91.9). Below this, there are tabs for Parameters, ACM, and Advanced. The main area is divided into two sections: MODEM and RADIO. Each section has columns for LOCAL and REMOTE CHANNEL 1. The MODEM section includes settings for Bandwidth (30000\_02), Max RxACM Profile (0016/strong), ACM function (man p1), and Advanced Setting (default). The RADIO section includes settings for T/R Spacing (fixed), TX Frequency (6660 MHz), RX Frequency (6935 MHz), TX Power Limit (33 dBm), TX Mute Config (muted), ATPC Function (unchecked), and ATPC RX Level (-50 dBm). There are buttons for REFRESH, UNDO, and APPLY LOCAL. On the left, there is a sidebar with navigation options like Status, Config, System, Access, IP, Radio, Ports, Alarms, Maintenance, and Tools. At the bottom left, there is a status box showing Date, Time, Uptime, and Modem Serial Number.

Figure 6-26 Parameters Tab

#### MODEM -

This frame contains the most important modem setting. It allows configuration of both local and remote side parameters. Note that the remote settings feature requires an active radio connection to the remote side in order to provision and apply the remote settings. Also note that you must store any changed setting separately in both local and remote side.

- Bandwidth – the bandwidth of the transmitting modulation. The number after the underscore indicates the variant of the modulation:
- \_01 – uses narrower frequency spectrum and lesser throughput than the \_02 bandwidths. Usable for applications where the set frequency is on the bandwidth edge affected by the outer RF interferences
- \_02 – modulations optimized for highest possible bandwidth and throughput of the corresponding transmitting mask
- \_03 – a special variant with different meaning across different applications:
- – wide BW: 80MHz only; uses extra narrow frequency spectrum to avoid internal interferences on 80MHz BW's. This allows for the maximal sensitivity at cost of throughput
- Max RxACM Profile – The highest possible modulation at given bandwidth. While the ACM function is enabled this value will be the highest possible modulation, otherwise this will be the actual modulation. Each modulation can have multiple Forward Error Correction variants:
- - medium – optimal FEC, medium throughput speed

- - strong – strong FEC, lowest throughput speed
- ACM Function – Adaptive Coded Modulation. The possible modes are following:
- - auto pX – automatic modulation switching using ACM profile number X
- - man pX – disables the ACM function. The modulation defined in the *Max RxACM Profile* field on the *Parameters* tab will be used for transmitting.
- Advanced Setting – Gear icon indicates that the Advanced radio settings does not match the factory defaults and leads the user to the Advanced radio settings page. If the Advanced radio settings is set to defaults such information will be displayed instead.

## RADIO –

This section contains the most important radio setting. It allows configuration of both local and remote side parameters. Note that the remote settings feature requires an active radio connection to the remote side in order to provision and apply the remote settings. Also note that you have to store any changed setting separately in both local and remote side.

- T/R Spacing – TX / RX frequency distance mode. Note that available options depends on the attached radio type and it's capabilities.
- TX Frequency – Transmission frequency can be set within the frequency range noted under the respective info icon in accordance with radio sub-band specification (read from the radio part). Such displayed range is the edge to edge flat diplexer frequency scope increased/decreased by one half of the used modulation bandwidth.
- RX Frequency – If *fixed* T/R spacing is selected the Receive frequency will be calculated automatically. If *manual* T/R spacing is selected the Receive frequency has to be calculated and specified manually.
- TX Power Limit – Maximum transmission power parameter defines the maximum power level which is required for optimal transmission conditions. The operating TxPower then depends on:
  - - configured ATPC values (if ATPC is enabled)
  - - radio part power limit (depends on the used RF band and selected modulation)
- TX Mute Config – Transmitter mute configuration. Three modes of this parameter can be selected:
  - - *auto* mute mode is the standard selection for this parameter. In this mode is the radio part automatically muted when required by design or when abnormal transmission conditions are detected by the device.
  - - *mute* mode for fixed radio mute configuration
  - - *unmute* option is available only on remote channels when there is not Rx connection from such remote channel. When selected the unmute command is send to the remote side which, if listening, will attempt to unmute it's respective Tx part.
- ATPC Function – Automatic Transmit Power Control enables or disables the ATPC feature. The transmitted power is automatically adjusted to ensure that the remote side will receive signal of strength defined in its respective *ATPC RxL Level* settings with hysteresis of +/- 2dBm (hitless regulation). Please note that this function will not work in Simplex links as it requires bi-directional communication.
- **Text color legend:**
- **black** – unmodified value
- **blue** – modified but non-applied value
- **red** – entered value does not match the allowed range or is incorrectly set

## 6.11.2. ACM Tab

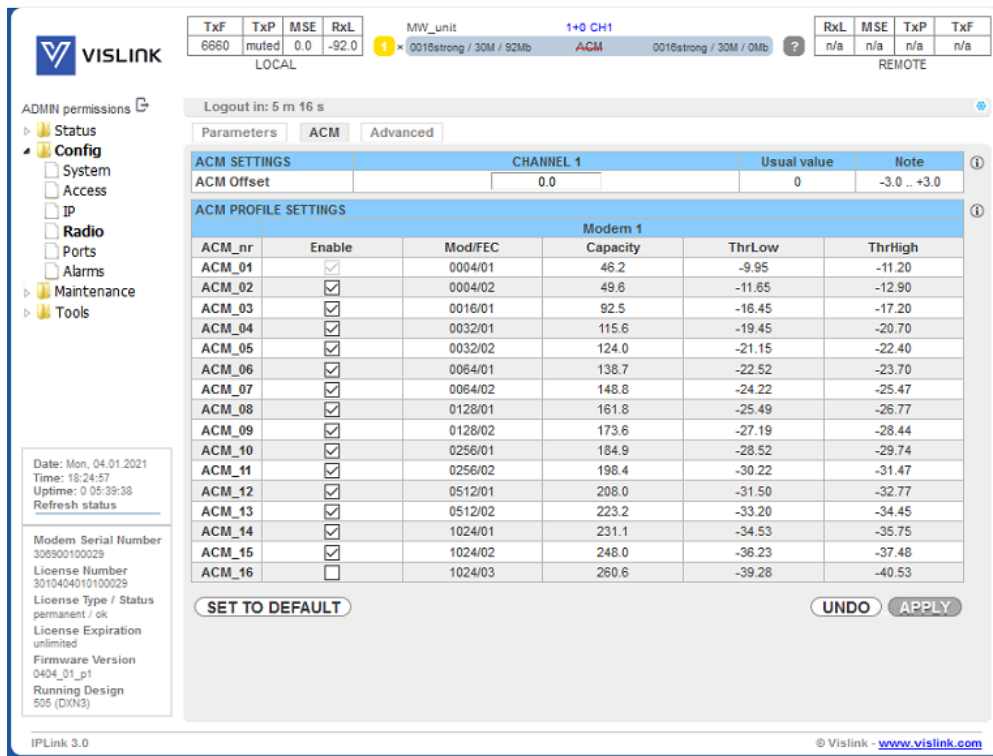

Logout in: 5 m 16 s

Parameters ACM Advanced

**ACM SETTINGS**

CHANNEL 1		Usual value	Note
ACM Offset	0.0	0	-3.0 .. +3.0

**ACM PROFILE SETTINGS**

Modem 1					
ACM_nr	Enable	Mod/FEC	Capacity	ThrLow	ThrHigh
ACM_01	<input checked="" type="checkbox"/>	0004/01	46.2	-9.95	-11.20
ACM_02	<input checked="" type="checkbox"/>	0004/02	49.6	-11.65	-12.90
ACM_03	<input checked="" type="checkbox"/>	0016/01	92.5	-16.45	-17.20
ACM_04	<input checked="" type="checkbox"/>	0032/01	115.6	-19.45	-20.70
ACM_05	<input checked="" type="checkbox"/>	0032/02	124.0	-21.15	-22.40
ACM_06	<input checked="" type="checkbox"/>	0064/01	138.7	-22.52	-23.70
ACM_07	<input checked="" type="checkbox"/>	0064/02	148.8	-24.22	-25.47
ACM_08	<input checked="" type="checkbox"/>	0128/01	161.8	-25.49	-26.77
ACM_09	<input checked="" type="checkbox"/>	0128/02	173.6	-27.19	-28.44
ACM_10	<input checked="" type="checkbox"/>	0256/01	184.9	-28.52	-29.74
ACM_11	<input checked="" type="checkbox"/>	0256/02	198.4	-30.22	-31.47
ACM_12	<input checked="" type="checkbox"/>	0512/01	208.0	-31.50	-32.77
ACM_13	<input checked="" type="checkbox"/>	0512/02	223.2	-33.20	-34.45
ACM_14	<input checked="" type="checkbox"/>	1024/01	231.1	-34.53	-35.75
ACM_15	<input checked="" type="checkbox"/>	1024/02	248.0	-36.23	-37.48
ACM_16	<input type="checkbox"/>	1024/03	260.6	-39.28	-40.53

SET TO DEFAULT UNDO APPLY

Date: Mon, 04.01.2021  
Time: 18:24:57  
Uptime: 0 05:39:38  
Refresh status

Modem Serial Number  
306900100029  
License Number  
3010404010100029  
License Type / Status  
permanent / ok  
License Expiration  
unlimited  
Firmware Version  
0404\_01\_p1  
Running Design  
505 (DXN3)

IPLink 3.0 © Vislink [www.vislink.com](http://www.vislink.com)

Figure 6-27 ACM Tab

### ACM SETTINGS –

The Hitless Adaptive modulation (ACM) settings.

- ACM Offset – The MSE offset off the pre-set ThrLow and ThrHigh constants (see ACM profiles)

### ACM PROFILE SETTINGS –

The list of available modulations for the selected ACM profile.

- ACM\_nr – designation of the modulation
- Enable – enables a modulation for ACM switching
- "I" means unlicensed modulation
- "e" means error setting
- "D" means not available in the selected profile
- Mod/FEC – bandwidth/forward error correction level
- Capacity – maximal throughput
- ThrLow – The MSE threshold value for switching from this respective modulation to a lower Rx modulation
- ThrHigh – The MSE threshold value for switching to this respective modulation

Note: the ACM settings of local and remote devices should match.

### 6.11.3. Advanced Tab

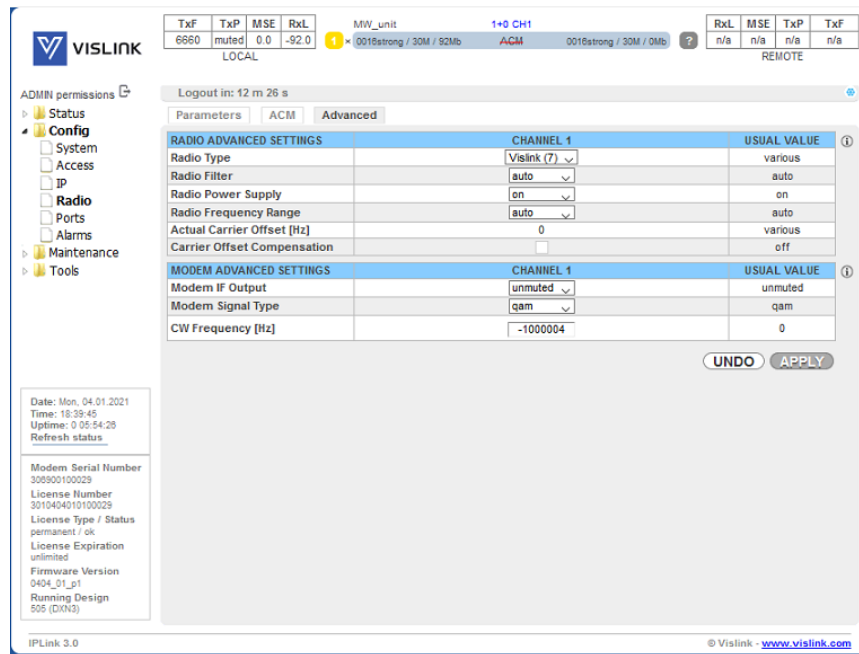

Figure 6-28 Advanced Tab

#### RADIO ADVANCED SETTINGS –

This frame provides various options for advanced radio part settings:

- Radio Type – selection of the attached radio type. Note this setting is available only on supported systems
- Radio Filter
- - auto – Filter is selected automatically according to the modulation BW (default)
- - narrow – Manual selection of narrow radio filter
- - wide – Manual selection of wide radio filter
- Radio Power Supply
- - on – enables power output to the respective radio part
- - off – disables power output to the respective radio part
- Radio Frequency Range
- - auto – the unit automatically calculates the usable frequency range by subtracting/adding half of the current bandwidth from the radio frequency edges
- - hw – the radio frequency limits are used. Note this is suitable only for special use cases
- Actual Carrier Offset – the current radio carrier offset. For the 3.5MHz bandwidth, it must be in the range from -40 000 to +40 000. Note this value will differ with each refresh.
- Carrier Offset Compensation – enabling this option enables the automatic radio carrier offset calibration. Note the calibration is bound to the currently attached ODU only and should be

Issue: No.

52

repeated when the ODU is replaced by means of disabling and re-enabling this checkbox. Use this option when there is no modem synchronization on very narrow bandwidths (3.5MHz). Unchecking this option resets the calibration. Please note enabling the auto-calibration will cause data to drop for about 3 sec. The calibration requires modem sync. The calibration may be done on a higher bandwidth or on the QPSK modulation when there is not possible to achieve the synchronization on the desired narrow modulation.

## MODEM ADVANCED SETTINGS –

This frame provides various options for advanced modem part settings:

- Modem Signal Type – Specification of modulation output. It is possible to replace standard modulated signal with carrier signal (CW) in this drop-down menu. The possible modes follows:
- - qam – TxIF modulated signal is presented at IF output from the device (default)
- - cw – Carrier signal with given frequency is presented at IF output
- CW Frequency – carrier signal frequency settings

## 6.12. Ports Page

### 6.12.1. MUX Tab

PORT	SFP1	SFP2	SFP3	SFP4	LAN1	LAN2	LAN3
Status	SFP No LINK	SFP Gbit FD	SFP module not present	SFP module not present	No LINK	No LINK	Gbit FULL
Hot Standby	off	off	off	off	off	off	-
Mode	auto1GX	force1GX	auto1GX	auto1GX	100M/Full	100M/Full	auto
MDIX	-	-	-	-	auto	auto	auto
Flow Control	force	force	force	force	off	off	off
1588	off	off	off	off	off	off	off

Figure 6-29 MUX Tab

### DATAFLOW CONFIGURATION PORT -

In respect of management access type, traffic modification (number of independent channels over air) and the aggregation function preference the user has to select the relevant Mode type (see the Mode settings ) before starting any port settings. Each Mode uses similar but not identical port configuration scheme. By default the

internal ETH switch is divided into four groups. Such setting prevents potential loops at connected LAN ports for all Modes. The port settings consist of several configuration layers labelled leftmost of the configuration window:

## PORTS

- SFP1-4 – 1G optical interface for user data or EMM card chain
- LAN1-2 – ethernet 1G (data) interface
- LAN3 – ethernet 1G (management) interface

### PORT CONFIG section:

- Status – status of a port as detected by the device (speed, duplex mode, link, administrative down status).
- Hot standby – automatic switch over between ports according to actual link status
- Mode – This drop-down menu displays and defines the actual port mode (speed/duplex, administrative down)
- MDIX – It is possible to set particular ETH cable crossing like auto/mdo/mdx by means of this configuration
- Flow Control – Informative field displays the actual duplex flow control mechanism settings. Flow control setting is available from page Ports / EthQOS
- 1588 – Precision time protocol source

### ETH SWITCH section:

This block illustrates the ETH switch fragmentation into groups and also their interconnection with physical LAN ports and internal WAN ports. The group configuration is performed on ETH VLAN page

### SWAP section:

- Channel Select – Settings of data multiplexor. By this settings you can cross connect a particular Switch port with a Mux Channel.
- Connected Port – Current settings of the SWAP block

### PBPM section:

Priority Based Packet Multiplexer settings

- Traffic Channel – shows boundary between the selected channel and port
- - PTPx – Precision time protocol channel
- - EMMx – EMM channel. Speed will be computed automatically
- - ETHxa – High priority data channel. Speed can be limited - see field color and bubble help
- - ETHxb – Low priority data channel. Speed can be limited - see field color and bubble help
- Speed Limit – speed value for transmitting data with priority falling from left to right
- Act Aggr Speed – it indicates the actual aggregated capacity. It depends on channels statuses and asymmetry. Actual aggregated capacity may be less than sum of available channels capacities.

### Available Speed section:

it indicates the available capacity of appropriate channel. This value depends on the actual modulation scheme and license speed limits.

### 6.12.2. EthVLAN Tab

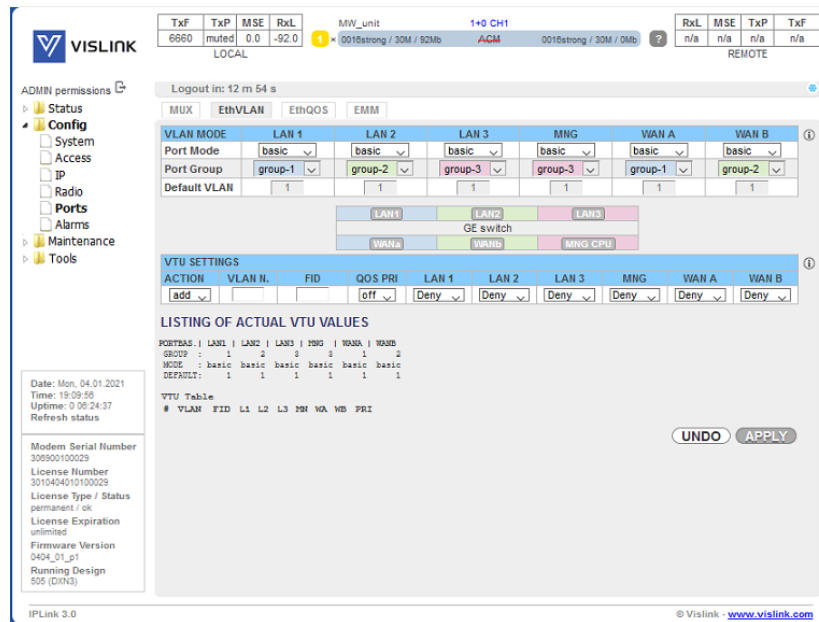

Figure 6-30 EthVLAN Tab

#### VLAN MODE –

VLAN configuration is primarily used for the separation of management traffic from other customer data traffics. It can be useful to configure ETH VLANs also for customer traffic and filter ingress data traffic using these settings in some specific applications. The description of particular configuration and display boxes:

- **Port mode** – it is possible to set-up the required VLAN mode separately for each ETH switch port. It is recommended to leave all ports in basic mode (802.1Q disabled at the port) and edit VTU records first. The user has to be sure with correct VLAN configuration and has to set also his network into the similar VLAN support. VLAN Port modes are described below:
- **basic** – T802.1Q VLAN mode is disabled. Only port group rules are applied. It is a transparent mode where VLAN settings in VTU table are ignored.
- **Ingress policy** – both untagged or tagged frames are accepted at port entry and exit only those ports of ETH switch which are members of the same group as the input port. The port default VLAN number is assigned as frame VID for next internal switch processing.
- **Egress policy** – frames are transmitted unchanged
- **access** – 802.1Q VLAN mode is enabled. VTU rules in conjunction with port group rules are applied. Such port is a member of just one VLAN defined in VTU table whose VID is identical with port Default VLAN number. This port is configured in such VLAN VTU record as untagged.
- **Ingress policy** – only untagged frames are accepted at entry port. Internal frame VID of such untagged frame is automatically assigned from port's Default VLAN. Frames are allowed to exit only those ports that belong to the frame's VLAN and are inside the same group as the input port.



- *Egress policy* – frames are transmitted untagged from this port. The egressing frame's VID is checked against VTU table and if VID doesn't exist in VTU table such frame is filtered (discarded).
- **trunk** – 802.1Q VLAN mode is enabled. VTU rules in conjunction with port group rules are applied. Port can be a member of more tagged VLANs according to VID extracted from VLAN tag and one untagged VLAN defined by port Default VLAN.
- *Ingress policy* – only such frames are accepted, whose VID assigned from VLAN tag (tagged frames) or port's Default VLAN (untagged frames) exist in VTU table, and the entry port is a member of such VLAN. Frames are allowed to exit only those ports that belong to the frame's VLAN and are inside the same group as the input port.
- *Egress policy* – frames are transmitted untagged or tagged according to the specification in VTU record table. The egressing frame's VID is checked against VTU table and if VID doesn't exist in VTU table such frame is filtered (discarded).
- **hybrid** – When frame's VID exists in VTU table the rules for trunk port are used when VID does not exist in VTU table, then the basic rules are applied.
- Port Group – This parameter defines a port's based grouping and defines separate MAC address table domains inside the internal switch to allow full MAC address tables (ATU table) isolating. Only the ports from the same group can communicate with one another. The other ports are entirely separated. It is possible that isolated networks (different groups) can use the same MAC addresses without any collision in the internal ETH switch ATU table.
- Default VLAN – This parameter is configured automatically depending on records in the VTU table. Default VLAN is updated for the port which is marked as untagged in the VTU record. VLAN No.1 cannot be added into VTU table since it is a default VLAN for internal purposes. The port cannot be configured into access mode when Default VLAN of this port is 1. When Default VLAN value for the trunk port is 1, then the port accepts tagged frames only.

Important! Improper settings of these parameters may cause network loopbacks or inability to manage the device. Please carefully check your settings before confirmation.

## VTU SETTINGS -

### Configuration of VTU records

- ACTION – It adds or removes VTU records. A VTU record cannot be deleted when contains untagged port which is configured in access mode. Just simple VLAN NO. specification is required for VTU record erase.
- VLAN N. – The VLAN number of edited VLAN (added or deleted). Please note the VLAN No. 0 & 1 are reserved by the system and can not be set; thus the valid VLAN No. is from 2 to 4095
- FID – Defines the MAC address database table for each VTU VLAN record. When more than one VLAN is added into the same FID table then such VLANs will share the same MAC address database; thus they will not be completely isolated. Usually, it is desired that each VLAN has its unique FID. Please note that the port Groups 1-4 are assigned to the MAC address databases FIDs 1-4, and thus these FIDs shouldn't be used for VTU VLAN separation (especially for VTU VLANs 2-4) unless the MAC table sharing between such defined VLAN and a particular port Group is the desired state.
- QOS PRI – When VTU override mode is selected then the QOS priority value of the original frame is overridden. This configuration has influence only on the internal frame processing by means of queue controller (QPRI defined by OQPRI instead of IQPRI bits), but frames are still egressed with the initial priority assignment (FPRI is without any change).
- LAN 1-WAN B – It defines VLAN mode for each port in configured VLAN.



- **Deny** – Port is not a member of edited VLAN. Ports which are defined in different Groups should be set into this mode.
- **Untag** – Port is a member of edited VLAN as untagged.
- **Tag** – Port is a member of edited VLAN as tagged.
- Please note the LAN3 port cannot be tagged as it is intended to be always available for local management access.

### LISTING OF ACTUAL VTU VALUES

List of VTU records (defined VLANs) in the ETH switch. The abbreviations in this list correspond to the first letter of the port mode definition in VTU records.

#### 6.12.3. EthQOS Tab

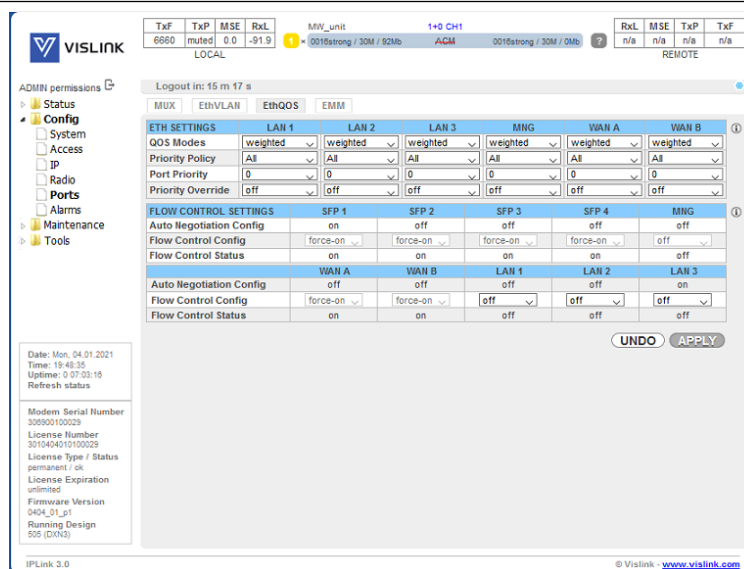

Figure 6-31 EthQOS Tab

#### ETH SETTINGS –

This frame makes it possible to configure extended QOS modes which are important for a specific traffic prioritization. The system uses four priority queues for each port where frames, with an assigned initial frame priority, an initial queue priority and an override queue priority, are mapped onto four output queues according to QPRI settings. A final frame queue priority is derived from the assigned initial queue or the override queue priority and it is used for deciding what queue will be used for frame buffering. The queue with a higher number is egressed with higher priority than the queues with lower numbers. The assigned initial frame priority is then used for replacing of frame's PRI bits in 802.3ac VLAN tag section, when the frame is egress tagged.

- QOS Modes
- **weighted** – In the weighted scheme an 8, 4, 2, 1 round robin weighting is applied to the four priorities (8 frames from Q3, 4 frames from Q2, 2 frames from Q1 and 1 frame from Q0). This approach prevents the lower priority frames from being starved out with only a slight delay to the higher priority frames.
- **strict 3xxx** – Strict priority for queue 3 and weighted round robin for queues 2,1 and 0. Queues 2,1,0 are served only when Q3 is empty.

- **strict 32xx** – Strict priority for queues 3,2 and weighted round robin for queues 1 and 0. Queues 1,0 are served only when Q3 and Q2 are empty.
- **strict 3210** – Strict priority for all queues. Lower priority queues are served only when higher priority queues are empty.
- Priority policy – This drop-down menu defines the initial ingress queue policy. It defines the initial rules for what output queue will be assigned to every ingress frame.
- Port Priority – The configuration of default port priority. Value 0 up to 7 can be entered (0 is default value)
- Priority Override – It offers the possibility to replace an initial queue priority with a new priority. The new priority is assigned to each frame whose VLAN ID is defined in the VTU table with properly configured QOS PRI value.
- **off** – QOS override is disabled
- **vtu** – Queue priority override information (OQPRI). When this parameter is set to off state, override process is not active for appropriate VTU record, even though Priority override is enabled on the port.

## FLOW CONTROL SETTINGS -

This setting affect the Flow Control settings of particular ports. The settings is allowed for only such ports and Modes where is such settings possible.

The possible values are:

- off – Flow control is disabled
- auto – Flow control is enabled during auto-negotiation process
- force-on – Flow control is active, even if connected device does not support it

### 6.12.4. EMM Tab

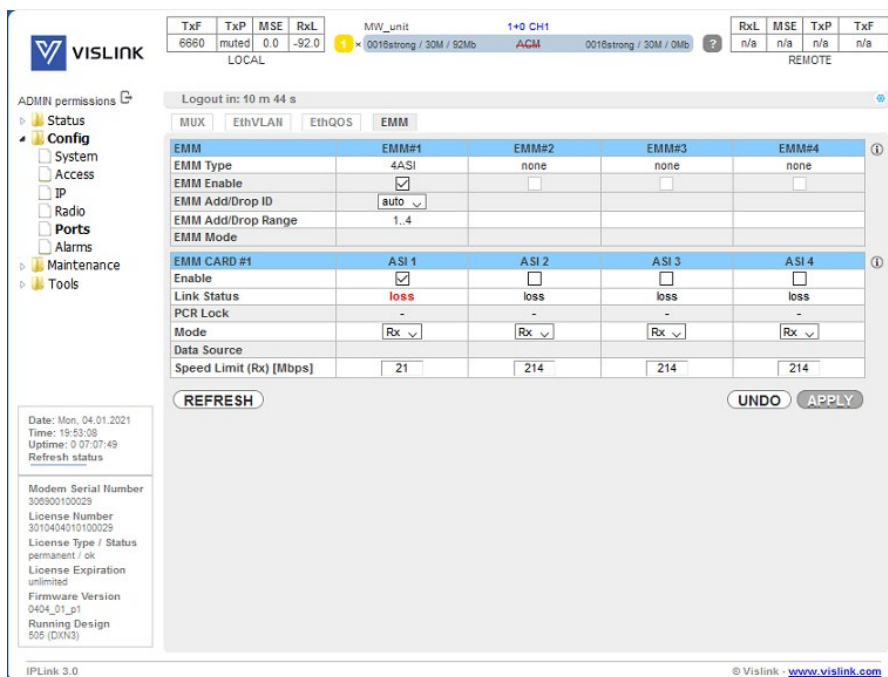

The screenshot displays the EMM configuration page in the Vislink web interface. The top navigation bar shows system status including TxP, MSE, RxL, MW\_unit, and CH1. The left sidebar contains a navigation menu with options like Status, Config, System, Access, IP, Radio, Ports, Alarms, Maintenance, and Tools. The main content area is titled 'EMM' and contains two tables of configuration parameters.

EMM	EMM#1	EMM#2	EMM#3	EMM#4
EMM Type	4ASI	none	none	none
EMM Enable	<input checked="" type="checkbox"/>	<input type="checkbox"/>	<input type="checkbox"/>	<input type="checkbox"/>
EMM Add/Drop ID	auto			
EMM Add/Drop Range	1,4			
EMM Mode				

EMM CARD #1	ASI 1	ASI 2	ASI 3	ASI 4
Enable	<input checked="" type="checkbox"/>	<input type="checkbox"/>	<input type="checkbox"/>	<input type="checkbox"/>
Link Status	loss	loss	loss	loss
PCR Lock	-	-	-	-
Mode	Rx	Rx	Rx	Rx
Data Source				
Speed Limit (Rx) [Mbps]	21	214	214	214

At the bottom of the configuration area, there are buttons for 'REFRESH', 'UNDO', and 'APPLY'. A 'Date' box on the left shows: Date: Mon, 04.01.2021, Time: 19:53:08, Uptime: 0 07:07:49, Refresh status.

Figure 6-32 EMM Tab

EMM –

The monitoring and setup of EMM cards basic functions.

- EMM Type – it displays the type of connected EMM card. The 'none' type indicates that particular position is empty, the 'RELAY-SYS' indicates that the relay IDU is connected directly to device's SFP port (relay application) or to EMM secondary SFP port (add/drop configuration).
- EMM Enable – this check box enables generation/reception of data frames to/from Fiber Optic stream. When EMM is enabled then EMM occupies an appropriate range of traffic port channels (described below).
- EMM Protection Failover – (1+1 mode only) in the secondary device role is Tx muted automatically and Rx is in Hi-Z when checked; when unchecked Tx is always active.
- EMM Add/Drop ID – In auto mode EMM card occupies port-channel range according to its position in EMM chain. For Add/Drop application it is sometimes necessary to set different (manual) Add/Drop ID, especially when EMM card should drop port channels from specific Add/Drop range.
- EMM Add/Drop Range – it displays appropriate port-channel range according to the EMM card position and EMM Add/Drop ID setting.
- EMM Mode – it selects the mode of connected EMM 16E1T1 card

EMM CARD #1 -

Settings for EMM-4ASI

- Enable – this checkbox selects which ASI ports are configured for DVB ASI connection. The necessary link capacity is automatically allocated according to the amount of all ASI Rx streams.
- Link Status – it displays the actual status of ASI port
- **In Rx mode:**
- **ok** - a valid ASI signal is presented at the appropriate input port
- **ok** - a valid ASI signal is presented at the appropriate input port, but the port is not enabled for traffic application.
- **Idle** - ASI signal detected and successfully synchronized, but the signal does not contain user data (MPEG stream is missing).
- **Idle** - ASI signal detected and successfully synchronized but the signal does not contain user data (MPEG stream is missing) and the particular port is not enabled for traffic application.
- **noSync** - indicates that synchronization was not established for current receiving ASI signal.
- **noSync** - indicates that synchronization was not established for current receiving ASI signal and the port is not enabled for traffic application.
- **loss** - no signal detected at ASI input port.
- **loss** - no signal detected at ASI input port and the port is not enabled for traffic application.
- **In Tx mode:**
- **ok** - a valid inbound signal is presented and transmitted via appropriate ASI port.
- **ok** - a valid inbound signal is presented, but the port is not enabled for transmission.
- **Idle** - the low-level code is detected, but the MPEG code was lost in the service.
- **Idle** - the low-level code is detected, but the MPEG code was lost in the service, and the particular port is not enabled for traffic application.
- **noSync** - high-level MPEG code was not detected.
- **noSync** - high-level MPEG code was not detected, and the particular port is not enabled for traffic application.

- PCR Lock – in Rx always 'lock', in Tx:
- **lock** – PCR recovery loop is locked
- **noLock** – PCR interval is not guaranteed
- Mode – specifies if the particular port operates in Rx (ingress from coaxial cable) or Tx (egress to coaxial cable) mode.
- Data Source – specifies the source for Tx signal. Either remote ASI port (Remote CH1-4) or one of available local ASI Rx port (Local Ch1-4) can be chosen. This setting is available in Tx mode only.
- Speed Limit – maximal data rate for inbound traffic to avoid overloading of overall link capacity. This setting is available in Rx mode only.

## 6.13. Alarms Page

### 6.13.1. Major Tab

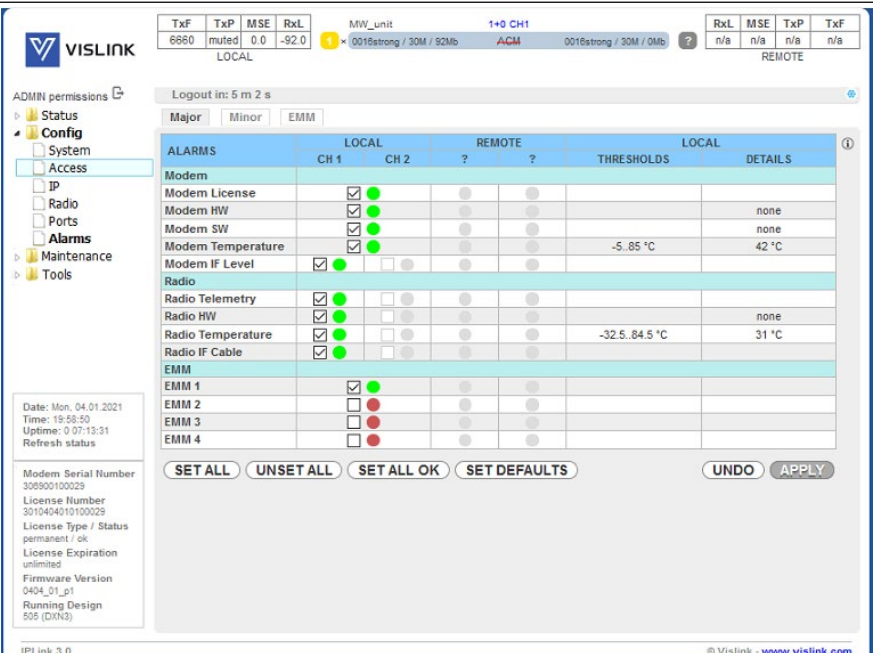

ALARMS	LOCAL		REMOTE		THRESHOLDS	LOCAL	DETAILS
	CH 1	CH 2	?	?			
Modem							
Modem License	<input checked="" type="checkbox"/>	<input checked="" type="checkbox"/>	<input type="checkbox"/>	<input type="checkbox"/>			none
Modem HW	<input checked="" type="checkbox"/>	<input checked="" type="checkbox"/>	<input type="checkbox"/>	<input type="checkbox"/>			none
Modem SW	<input checked="" type="checkbox"/>	<input checked="" type="checkbox"/>	<input type="checkbox"/>	<input type="checkbox"/>			none
Modem Temperature	<input checked="" type="checkbox"/>	<input checked="" type="checkbox"/>	<input type="checkbox"/>	<input type="checkbox"/>	-5.85 °C		42 °C
Modem IF Level	<input checked="" type="checkbox"/>	<input type="checkbox"/>	<input type="checkbox"/>	<input type="checkbox"/>			
Radio							
Radio Telemetry	<input checked="" type="checkbox"/>	<input type="checkbox"/>	<input type="checkbox"/>	<input type="checkbox"/>			
Radio HW	<input checked="" type="checkbox"/>	<input type="checkbox"/>	<input type="checkbox"/>	<input type="checkbox"/>			none
Radio Temperature	<input checked="" type="checkbox"/>	<input type="checkbox"/>	<input type="checkbox"/>	<input type="checkbox"/>	-32.5..84.5 °C		31 °C
Radio IF Cable	<input checked="" type="checkbox"/>	<input type="checkbox"/>	<input type="checkbox"/>	<input type="checkbox"/>			
EMM							
EMM 1	<input checked="" type="checkbox"/>	<input type="checkbox"/>	<input type="checkbox"/>	<input type="checkbox"/>			
EMM 2	<input type="checkbox"/>	<input type="checkbox"/>	<input type="checkbox"/>	<input type="checkbox"/>			
EMM 3	<input type="checkbox"/>	<input type="checkbox"/>	<input type="checkbox"/>	<input type="checkbox"/>			
EMM 4	<input type="checkbox"/>	<input type="checkbox"/>	<input type="checkbox"/>	<input type="checkbox"/>			

Figure 6-33 Major Tab

#### ALARMS –

In this frame are listed possible events with direct immediate impact on the link operability.

For correct protection role switching the user have to appropriately configure all the **Pri/Sec switch** alarms. Only such alarm which is enabled and listed as Pri/Sec switch will be used for protection switching provided that there are not any protection alarms active on the peer unit.

Description of available alarms:

- Modem License – This alarm will be raised when the license file is about to expire or is expired already or contains an invalid data
- Modem HW – A hardware problem with the device such as non-working ventilator
- Modem SW – A software problem such as incompatible mode selection on local and remote side
- Modem Temperature – The temperature of the modem part

Issue: No.

60

Ref: IPL3-ASUM-8000

Copyright © Vislink

- Modem IF Level – This alarm indicates low or high level of modem input (140 MHz)
- Radio Telemetry – The status of communication with the radio part
- Radio HW – The status as reported by the radio part
- Radio Temperature – The temperature of the radio part
- Radio IF Cable – This alarm indicates bad radio IF input (350 MHz)
- EMM 1-4 – The status of bidirectional FO communication with respective EMM card

### 6.13.2. Minor Tab

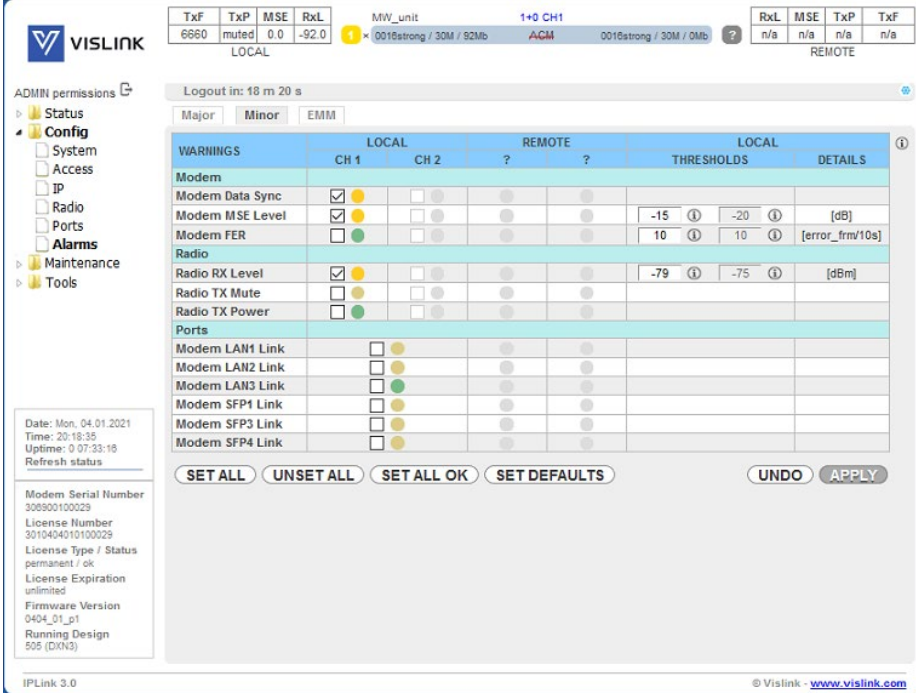

Figure 6-34 Minor Tab

#### WARNINGS -

In this frame are listed possible events with partial immediate impact on the link.

For correct protection role switching the user have to appropriately configure all the **Pri/Sec switch** alarms. Only such alarm which is enabled and listed as Pri/Sec switch will be used for protection switching provided that there are not any protection alarms active on the peer unit.

Description of available alarms:

- Modem Data Sync – This alarm indicates actual status of packet processor (PBPS) synchronization.
- Modem MSE Level – Link quality indicator threshold settings and status. You can check the usual MSE values in the ACM profile table under menu Radio/ACM.
- Modem FER – The threshold for error frames per 10s

- Radio RX Level – The receiving level threshold
- Radio TX Mute – Transmitting Mute status
- Radio TX Power – Transmitting Power status
- Modem LAN1/2/3 Link – Status of the LAN port Link
- Modem SFP1/2/3/4 Link – Status of the SFP port Link

### 6.13.3. EMM Tab

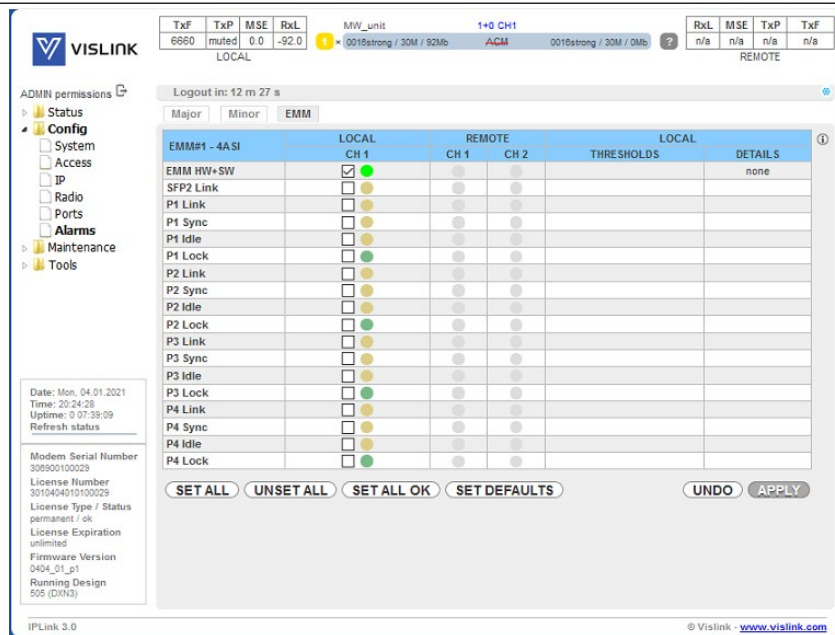

The screenshot shows the Vislink EMM Tab interface. At the top, there are status indicators for TxP, MSE, RxL, and MW\_unit. Below this, there are tabs for LOCAL and REMOTE. The main area is a table with columns for EMM#1 - 4ASI, LOCAL CH 1, REMOTE CH 1, REMOTE CH 2, THRESHOLDS, and DETAILS. The table contains various status indicators for different components like EMM HW+SW, SFP2 Link, P1 Link, P1 Sync, P1 Idle, P1 Lock, P2 Link, P2 Sync, P2 Idle, P2 Lock, P3 Link, P3 Sync, P3 Idle, P3 Lock, P4 Link, P4 Sync, P4 Idle, and P4 Lock. Each row has a checkbox and a colored circle (green, yellow, or red) indicating the status. At the bottom, there are buttons for SET ALL, UNSET ALL, SET ALL OK, SET DEFAULTS, UNDO, and APPLY. On the left side, there is a sidebar with navigation options like Status, Config, System, Access, IP, Radio, Ports, Alarms, Maintenance, and Tools. At the bottom left, there is a section for Modem information including Date, Time, Uptime, Refresh status, Modem Serial Number, License Number, License Type / Status, License Expiration, Firmware Version, and Running Design.

Figure 6-35 EMM Tab

EMM#1 – 4ASI –

Alarms for EMM-4ASI

- EMM HW+SW – Overall EMM status. Possible values are:
- fifo overflow – Overall EMM Rx stream speed exceeded the available link throughput
- src ID – Mishmash in remote EMM settings. For example, when you try to operate ASI card against a 16E1/T1 card.
- SFP2 Link – Status of secondary SFP port Link
- ASI Px Link
- in Tx – Will be always ok
- in Rx – Status of ASI Rx port Link
- ASI Px Idle – An unexpected pause in user data (MPEG stream is missing)
- ASI Px Sync – Synchronization status to current ASI signal. Can occur when there is, for example, RF link synchronization event or when ASI data are corrupted.
- ASI Px Lock
- in Tx – ASI PCR lock status. After a synchronization, it can take up to a minute until it is correctly aligned. Other events which could result in this alarm are ACM modulation shifting, Protection shifting, a variable ASI stream speed or a link errors.
- in Rx – Will be always ok

Issue: No.

62

## 6.14. Configuration Page

### 6.14.1. Save&Run Tab

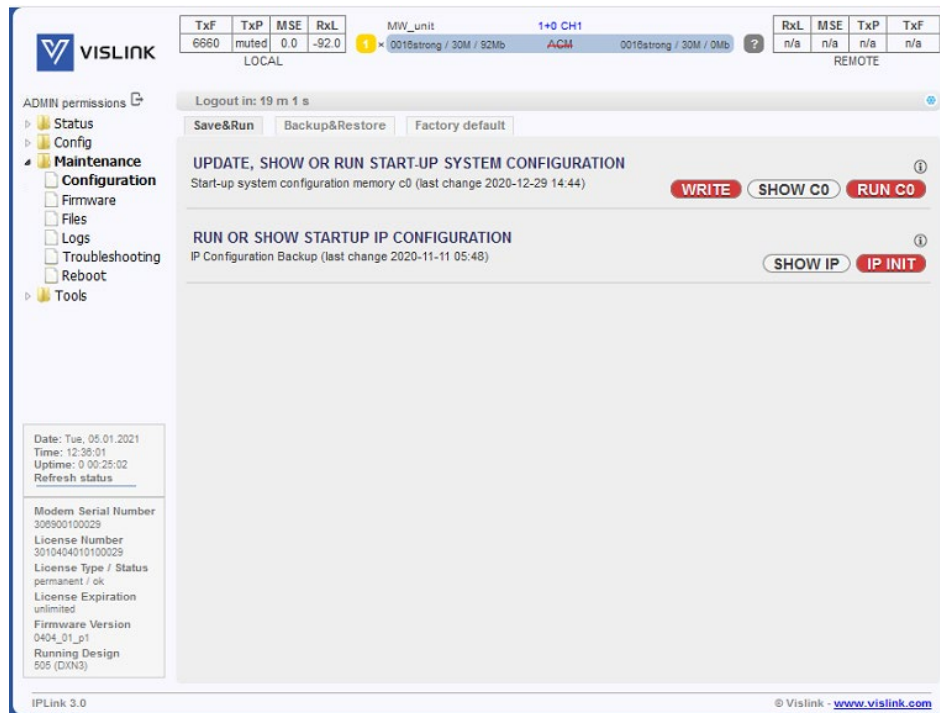

Figure 6-36 Save&Run Tab

#### UPDATE, SHOW OR RUN START-UP SYSTEM CONFIGURATION –

This frame allows to store, display/export and execute the startup configuration.

- **WRITE** – store the actual configuration
- **SHOW C0** – shows the device's stored startup configuration as list of commands. Note that the order of commands in this frame matters. Also note that this configuration is not automatically updated unless this button is pressed again.
- **RUN C0** – this will execute the current start up memory content. Note that this action will cause data loss and all unsaved configuration changes.

#### RUN OR SHOW STARTUP IP CONFIGURATION –

This frame allows to display/export stored IP settings of the device and reinitiate all IP interfaces.

- **SHOW IP** – shows the device IP configuration as list of commands. Note that this configuration is not automatically updated unless this button is pressed again.



- IP INIT – this will execute the current start up memory IP settings content as well as re-initiate of IP interfaces. Note that this action will not cause user data loss, but it will disconnect all active management sessions.

### 6.14.2. Backup&Restore Tab

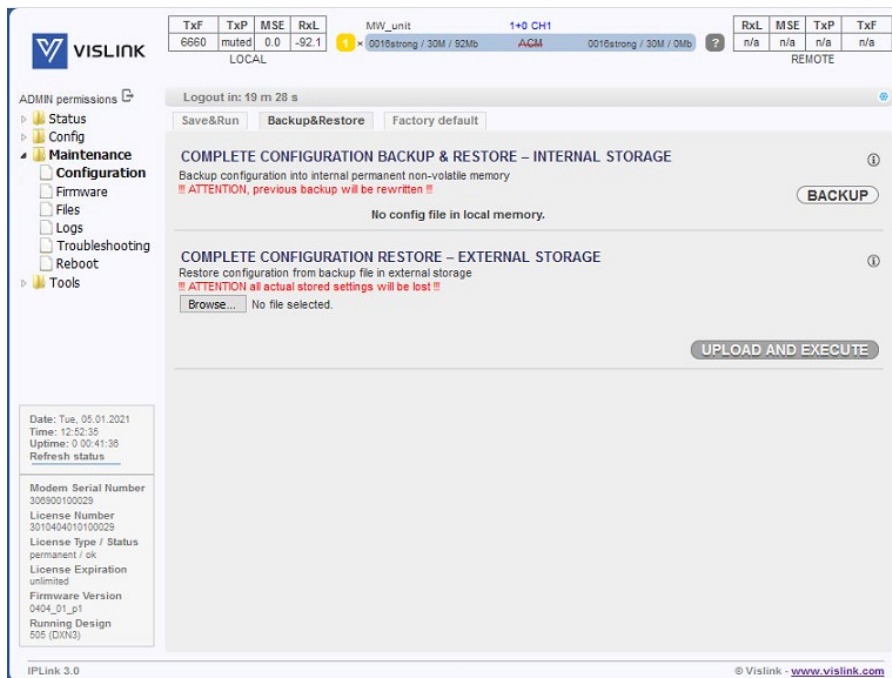

Figure 6-37 Backup&Restore Tab

#### COMPLETE CONFIGURATION BACKUP & RESTORE – INTERNAL STORAGE –

This frame allows to BACKUP the start up configuration into the internal restart persistent memory. Please note that only stored configuration will be backed up. Only one backup is allowed.

Please note that this backup is not automatically updated after firmware upgrade and thus it should be re-generated by the user manually.

The RESTORE button will appear if there is a configuration file stored. Such file can be downloaded from this frame directly.

#### Important notes:

- - After pressing the *RESTORE* button the start-up configuration will be immediately replaced by the restored configuration.
- - The restored configuration is **not automatically activated**. You must invoke the *run c0* or perform soft reboot in order to activate it.
- - Please note that the RESTORE should be performed on the same FW version as it was created!



## COMPLETE CONFIGURATION RESTORE – EXTERNAL STORAGE –

On this frame you can select and upload previously saved configuration file (\*.afw) from external location.

### Important notes:

- - After pressing the *Upload and Execute* button the start-up configuration will be immediately replaced by the restored configuration.
- - The restored configuration **is not automatically activated**. You must invoke the *run c0* or perform soft reboot in order to activate it.
- - Please note that the RESTORE should be performed on the same FW version as it was created!

### 6.14.3. Factory default Tab

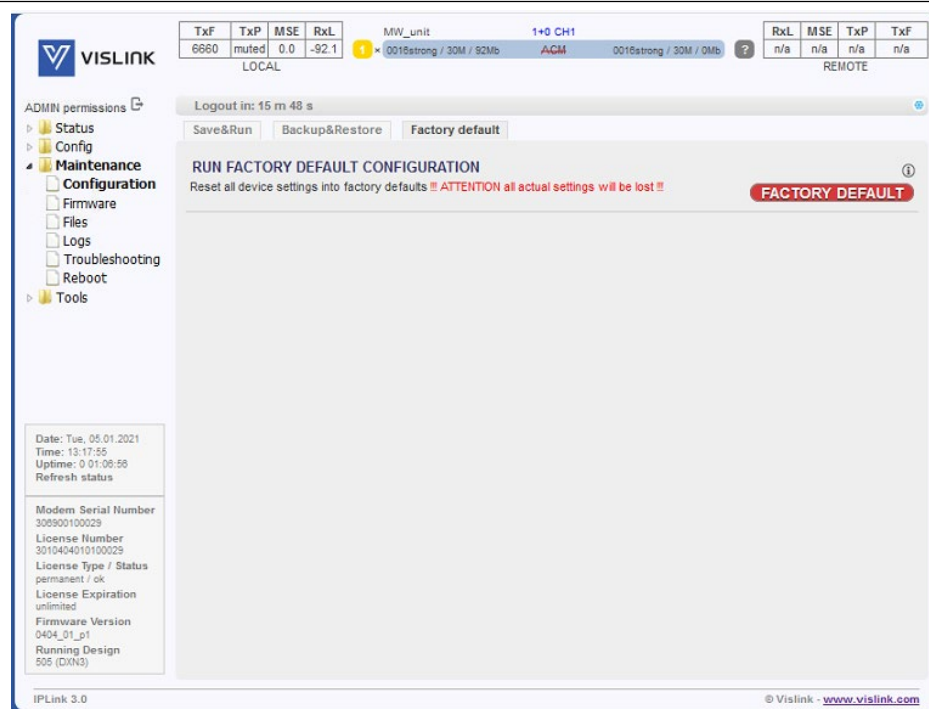

Figure 6-38 Factory default Tab

### FACTORY DEFAULT -

Restores the configuration of the device to its factory pre-set values including credentials, radio, and IP settings.

**Note:** Please make sure that you have physical access to the device and that you know the Factory Default IP addresses (10.10.10.10 for MNG or 10.10.11.10 for USB port) and default credentials.

**Note:** The device will be rebooted automatically!

## 6.15. Firmware Page

### 6.15.1. Upgrade Tab

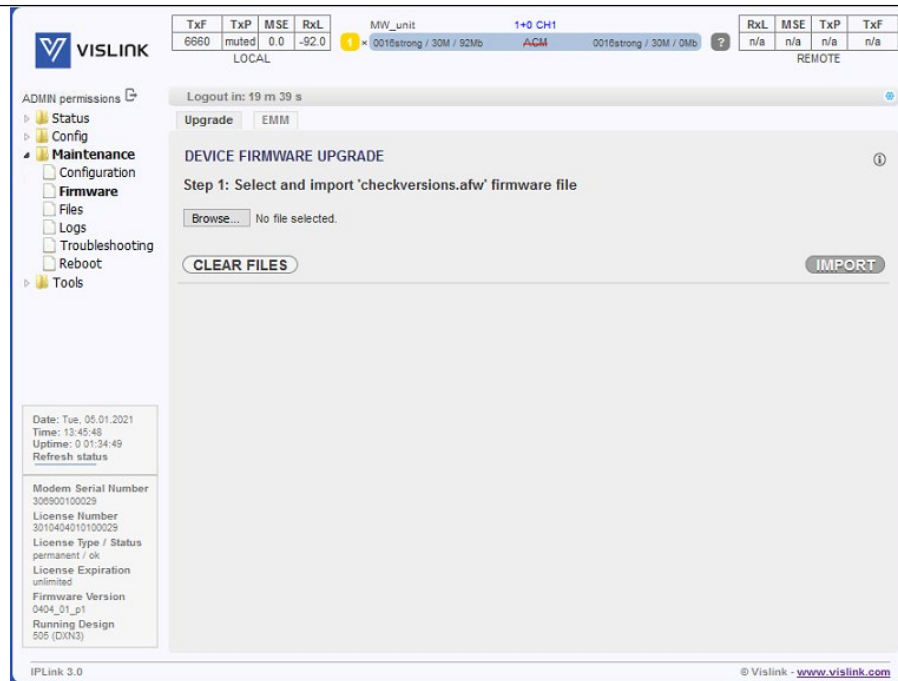

Figure 6-39 Upgrade Tab

#### DEVICE FIRMWARE UPGRADE -

Firmware upgrade wizard. This wizard consists of three steps necessary for firmware upgrade procedure:

- Step 1 – First step in the firmware upgrade procedure. The file 'checkversions.afw' compares information about all packages of the target FW with packages currently running on the device. Note this package can be found as a part of the firmware release and differs for every FW version.
- **Clear Files** - This button will delete all the firmware installation files already stored in the device. This is useful when you want to start the upgrade process over or when you are experiencing an issue with the upgrade using this guided procedure, for example, due to interruption of a previous upgrade.
- Step 2 – In this step, the user has to upload all required parts of the new firmware. Only such packages which were evaluated in the first step as outdated will be required.
- Step 3 – This final step will appear once all required files are uploaded on the device. It consists of a single button which will perform the update. Two different buttons can occur depending on the device configuration:
- **Upgrade Modem & EMM** - This button will simultaneously update modem, and all attached outdated EMM cards.
- **Upgrade Modem** - Modem only update. This button will be displayed if no EMM cards are present or if such cards do not require an update.

### Important notes:

- Firmware upgrade initialized in Step 3 will cause data drop - approximately one minute for the modem part plus about 30 seconds per each attached EMM card.
- Firmware versions should match all devices in the link.
- After the firmware upgrade, you should re-generate all pertinent configuration backups if such exists.
- All files uploaded are restart-persistent. This allows to upload all required parts in advance and initialize the upgrade later.

### 6.15.2. EMM Tab

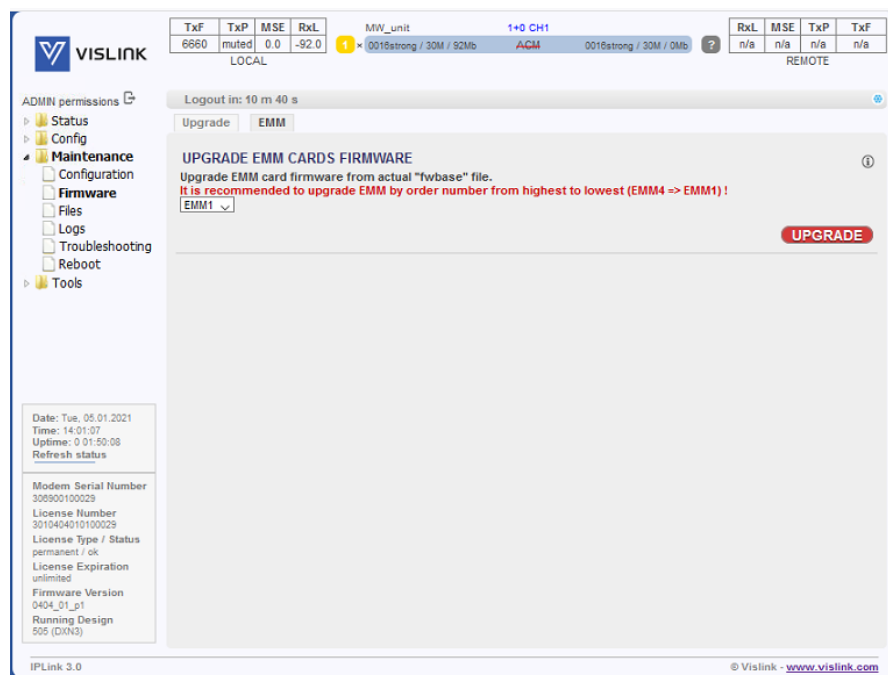

Figure 6-40 EMM Tab

### UPGRADE EMM CARDS FIRMWARE –

This frame allows to upgrade firmware in attached EMM cards. Please note that it is recommended to update EMM cards in reverse order:

EMM4 ->EMM3->EMM2->EMM1

Also note that there will be a data drop for about 15 seconds per one module.

## 6.16. Files Page

### 6.16.1. Exports Tab

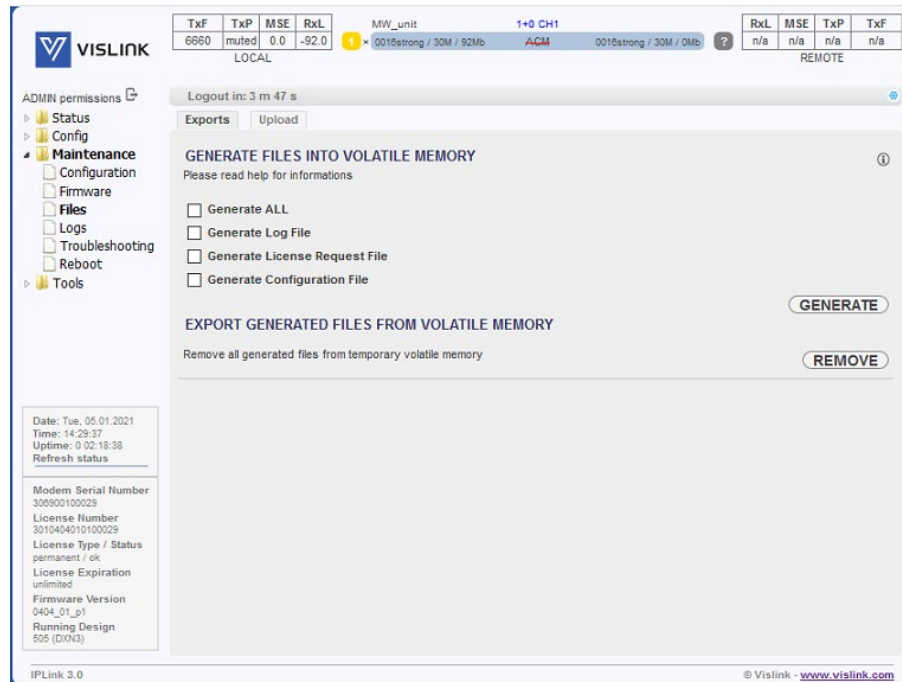

Figure 6-41 Exports Tab

#### GENERATE FILES INTO VOLATILE MEMORY -

This frame allows to collect various device reports as a downloadable archives in order to provide such files for off-site problem diagnostics and backup. The selected files can be collected by means of pressing the GENERATE button which will result in appropriate number of downloadable files listed in the sub-section EXPORT GENERATED FILES FROM VOLATILE MEMORY. Please note that such files are erased during restart of the device or by means of the REMOVE button.

- Generate ALL – selects all below listed items for file generation at once.
- Generate Log File – archive of various log files for debugging purposes with link configuration and condition as plain text files.
- Generate License Request – a binary file with current license status. This file is meant for extending license expiration date.
- Generate Configuration File – a binary file with complete configuration of the device. This file can be used for backing up the configuration or for transfer of such configuration into another device. Please note that the configuration transfer should be done only between devices with matching firmware versions. Also please note that this file cannot be read by the user.

## 6.16.2. Upload Tab

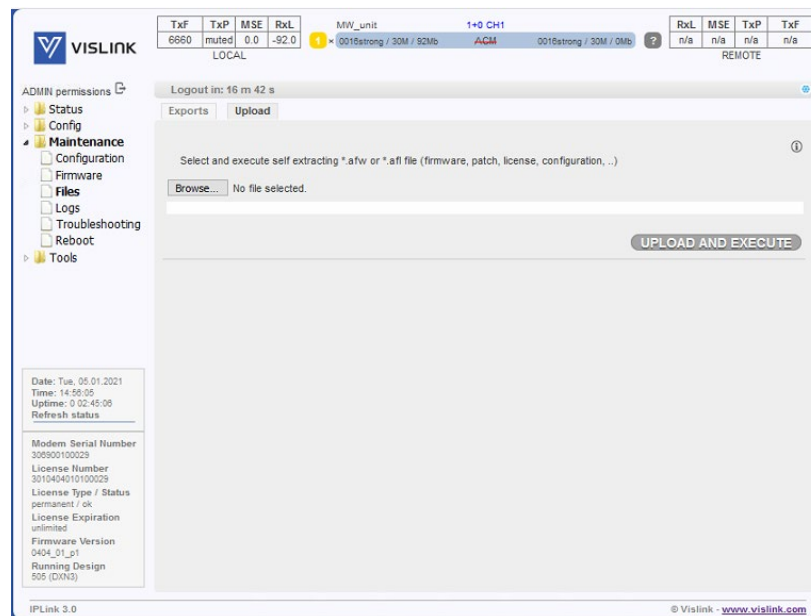

Figure 6-42 Upload Tab

In order to upgrade device's firmware, configuration or license the user should select the appropriate file and press the UPLOADED AND EXECUTE button. The common format of files is:

- Firmware – (load files in this order)
  - - hwbaseXXX.afw – software for internal HW parts
  - - oskernel.afw – operating system
  - - fwbase.afw – application software (WEB, SNMP, commands, etc.)
- Configuration
  - - fwconf\_OriginatingSN\_Timestamp.afw (as fwconf\_3010501010100008\_1702141508.afw)
- License
  - - licSN.afw (as lic3010501010100008.afw)

The name of files does not matter but the extension does. Please note that the device file validation is case sensitive so \*.afw does not equal to \*.AFW.

### Firmware upgrade procedure

In order to manually upgrade the device:

1. – save the current configuration by means of pressing the WRITE button
2. – gradually select all files in order as described above. Please note that after uploading of the fwbase.afw file the device performs automatic reboot

Please note that firmware downgrade is not officially supported, and such action can cause malfunction of the device. The full upgrade procedure is described in Firmware\_Release\_Notes document which is distributed together with new firmware versions. Also please note that the firmware upgrade will not alter any customizing

options except for explicitly stated cases described in the Firmware\_Release\_Notes document. All devices in a link should operate the same firmware version.

## 6.17. Logs Page

### 6.17.1. System Tab

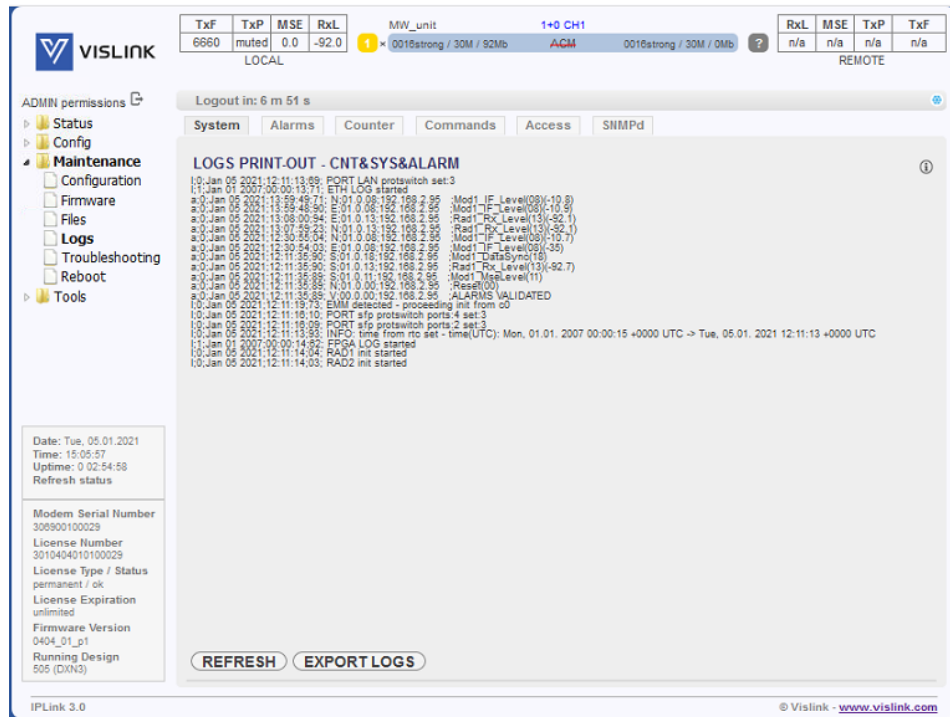

The screenshot displays the Vislink web interface for a device. At the top, there are status indicators for TxP, MSE, RxL, and MW\_Unit. Below this is a navigation menu with options like Status, Config, Maintenance, and Tools. The main content area is titled 'LOGS PRINT-OUT - CNT&SYS&ALARM' and contains a list of system events with timestamps and descriptions. On the left, there is a sidebar with system information including Date, Time, Uptime, and various numbers. At the bottom of the log area, there are 'REFRESH' and 'EXPORT LOGS' buttons.

TxF	TxP	MSE	RxL	MW_Unit	1+0 CH1	RxL	MSE	TxP	TxF
6660	muted	0.0	-92.0	0016strong / 30M / 92Mb	ACM	0016strong / 30M / 0Mb	n/a	n/a	n/a

Logout in: 6 m 51 s

System | Alarms | Counter | Commands | Access | SNMPd

**LOGS PRINT-OUT - CNT&SYS&ALARM**

```

1,0,Jan 05 2021:12:11:13:69: PORT LAN protoswitch set:3
1,1,Jan 01 2007:00:00:13:71: ETH LOG started
a,0,Jan 05 2021:13:59:46:71: N:01 0 08:192.168.2.95 :Mod1 IE_Level(05V-10.5)
a,0,Jan 05 2021:13:59:48:50: E:01 0 08:192.168.2.95 :Mod1 IE_Level(05)-10.5)
a,0,Jan 05 2021:13:08:00:94: E:01 0 13:192.168.2.95 :Rad1 Rx_Level(13)-92.1)
a,0,Jan 05 2021:13:07:55:24: N:01 0 13:192.168.2.95 :Rad1 Rx_Level(13)-92.1)
a,0,Jan 05 2021:12:30:55:04: N:01 0 08:192.168.2.95 :Mod1 IE_Level(05)-10.7)
a,0,Jan 05 2021:12:30:54:03: E:01 0 08:192.168.2.95 :Mod1 IE_Level(05)-10.7)
a,0,Jan 05 2021:12:11:35:50: E:01 0 18:192.168.2.95 :Mod1 DataSync(18)
a,0,Jan 05 2021:12:11:35:50: S:01 0 13:192.168.2.95 :Rad1 Rx_Level(13)-92.7)
a,0,Jan 05 2021:12:11:35:50: S:01 0 11:192.168.2.95 :Mod1 IE_Level(11)
a,0,Jan 05 2021:12:11:35:50: N:01 0 00:192.168.2.95 :Reset(00)
a,0,Jan 05 2021:12:11:35:50: I:00 0 00:192.168.2.95 :ALARMS VALIDATED
1,0,Jan 05 2021:12:11:19:70: EMM detected - proceeding init from cd
1,0,Jan 05 2021:12:11:18:10: PORT sfp protoswitch ports:4 set:3
1,0,Jan 05 2021:12:11:18:09: PORT sfp protoswitch ports:2 set:3
1,0,Jan 05 2021:12:11:13:50: NFO: time from rto set - time(UTC): Mon, 01.01. 2007 00:00:15 +0000 UTC -> Tue, 05.01. 2021 12:11:13 +0000 UTC
1,1,Jan 01 2007:00:00:14:52: CP&A LOG started
1,0,Jan 05 2021:12:11:14:04: RAD1 init started
1,0,Jan 05 2021:12:11:14:03: RAD2 init started
  
```

Date: Tue, 05.01.2021  
Time: 15:05:57  
Uptime: 0 02:54:58  
Refresh status

Modem Serial Number  
308900100029

License Number  
3070404010100029

License Type / Status  
permanent / ok

License Expiration  
unlimited

Firmware Version  
0404\_01\_p1

Running Design  
505 (D1X3)

REFRESH EXPORT LOGS

IPLink 3.0 © Vislink - www.vislink.com

Figure 6-43 System Tab

#### LOGS PRINT OUT – CNT&SYS&ALARM –

This frame provides historical data of the device condition. Sections enlisted under this page are independent on the current alarm settings so all events will be recorded. The historic span of this information’s depends on the link condition – a lot of events will cause quicker filling of these logs and sooner overwriting of the oldest records.

- System Log – System events such as license action, radio configuration changes, etc.

## 6.17.2. Alarms Tab

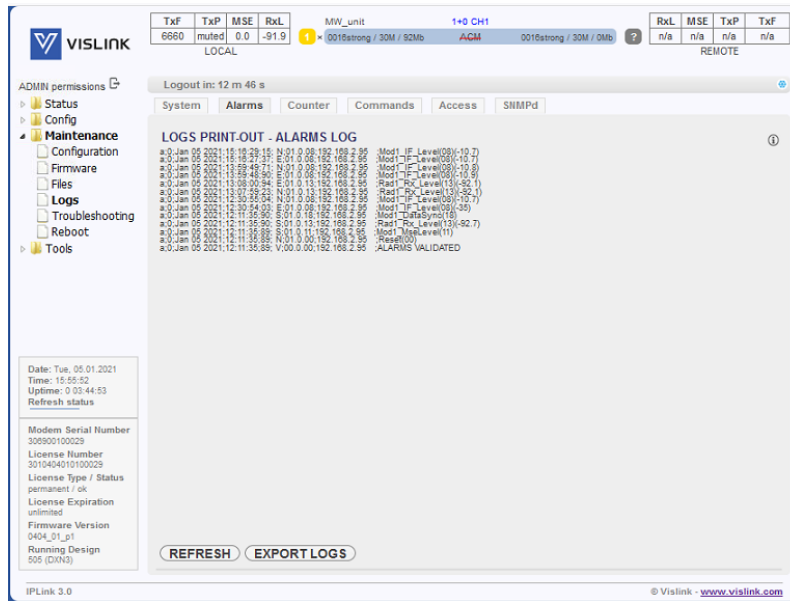

Figure 6-44 Alarms Tab

### LOGS PRINT-OUT – ALARMS LOG –

This frame provides historical data of the device condition. Sections enlisted under this page are independent on the current alarm settings so all events will be recorded. The historic span of this information's depends on the link condition – a lot of events will cause quicker filling of these logs and sooner overwriting of the oldest records.

- Alarm Log – The alarm log

## 6.17.3. Counter Tab

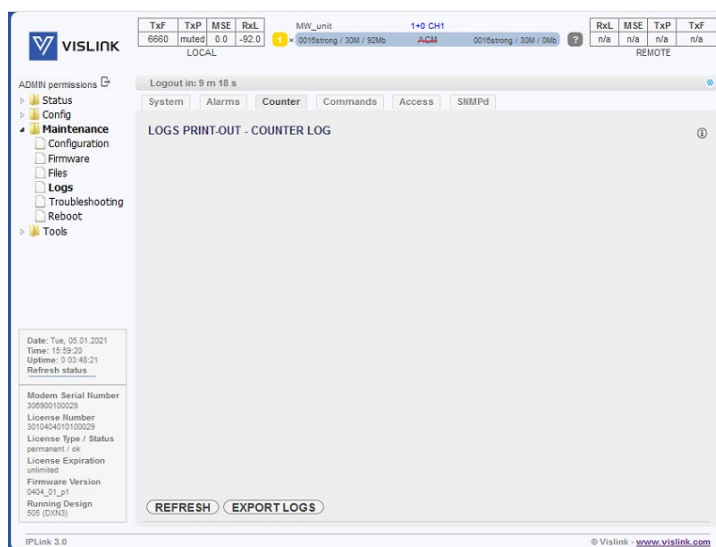

Figure 6-45 Counters Tab

## LOGS PRINT-OUT – COUNTER LOG –

This frame provides historical data of the device condition. Sections enlisted under this page are independent on the current alarm settings so all events will be recorded. The historic span of this information’s depends on the link condition – a lot of events will cause quicker filling of these logs and sooner overwriting of the oldest records.

- Counter Log – System counter events. When an error is detected or resolved this file is appended by the actual link parameters in such moment

### 6.17.4. Commands Tab

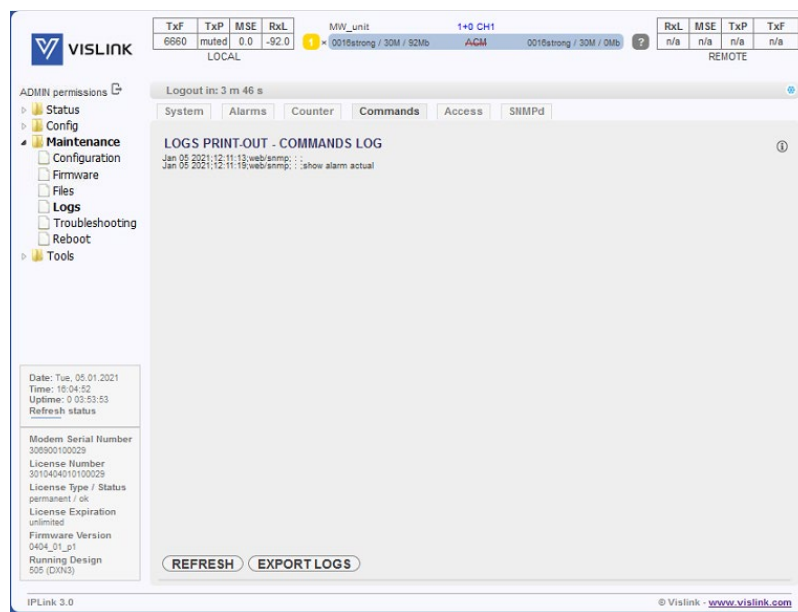

Figure 6-46 Commands Tab

## LOGS PRINT-OUT – COMMANDS LOG –

This frame provides historical data of the device condition. Sections enlisted under this page are independent on the current alarm settings so all events will be recorded. The historic span of this information’s depends on the link condition – a lot of events will cause quicker filling of these logs and sooner overwriting of the oldest records.

- Commands Log – History of performed commands



### 6.17.5. Access Tab

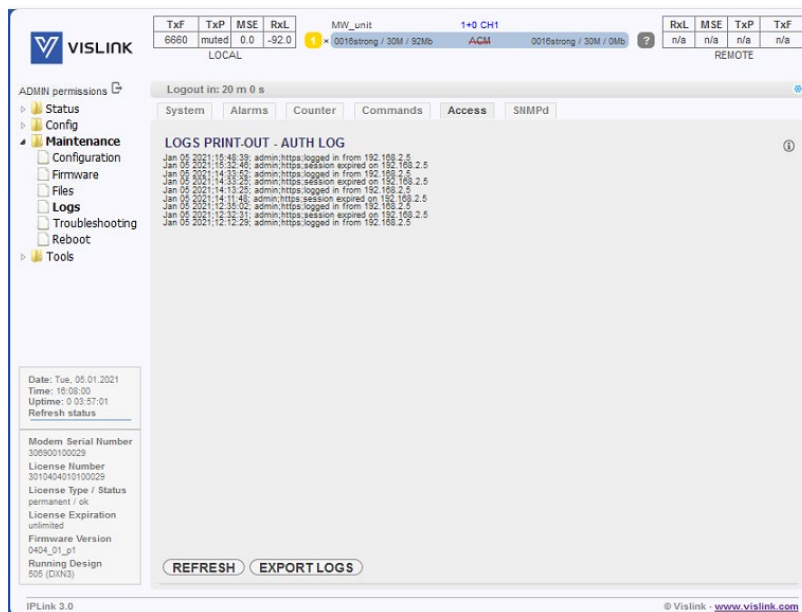

Figure 6-47 Access Tab

### LOGS PRINT-OUT – AUTH LOG –

This frame provides historical data of the device condition. Sections enlisted under this page are independent on the current alarm settings so all events will be recorded. The historic span of these informations depends on the link condition – a lot of events will cause quicker filling of these logs and sooner overwriting of the oldest records.

- Access Log – Authentication history

### 6.17.6. SNMP Tab

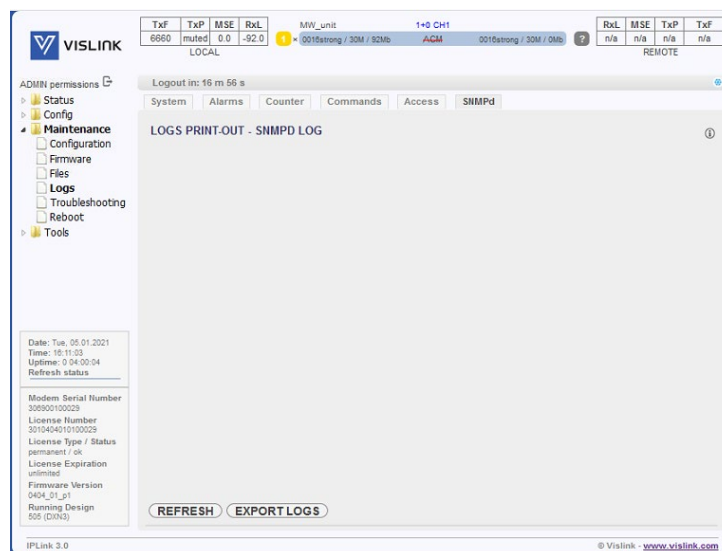

Figure 6-48 SNMPd Tab

## LOGS PRINT-OUT – SNMP LOG –

This frame provides historical data of the device condition. Sections enlisted under this page are independent on the current alarm settings so all events will be recorded. The historic span of these information depends on the link condition – a lot of events will cause quicker filling of these logs and sooner overwriting of the oldest records.

- SNMP Log – Reports of the internal SNMP daemon

## 6.18. Troubleshooting Page

### 6.18.1. Assistant Tab

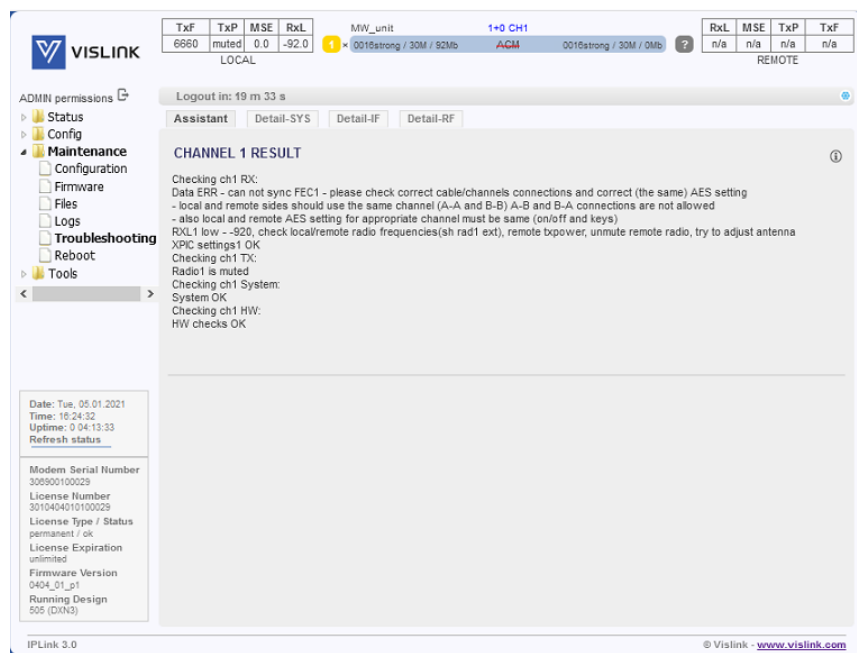

The screenshot displays the Vislink Assistant Tab interface. At the top, there are performance metrics for TxP, MSE, RxL, and MW\_unit. Below this, a navigation menu on the left includes Status, Config, Maintenance (with sub-items like Configuration, Firmware, Files, Logs, Reboot), and Tools. The main content area is titled 'CHANNEL 1 RESULT' and contains the following text:

```

Checking ch1 RX:
Data ERR - can not sync FEC1 - please check correct cable/channels connections and correct (the same) AES setting
- local and remote sides should use the same channel (A-A and B-B) A-B and B-A connections are not allowed
- also local and remote AES setting for appropriate channel must be same (on/off and keys)
RxL1 low -> -920, check local/remote radio frequencies(sh rad1 ext), remote txpower, unmute remote radio, try to adjust antenna
XPIC settings1 OK
Checking ch1 TX:
Radio1 is muted
Checking ch1 System:
System OK
Checking ch1 HW:
HW checks OK
  
```

At the bottom left, there is a status box with the following information:

```

Date: Tue, 05.01.2021
Time: 18:24:32
Uptime: 0 04:13:33
Refresh status
Modem Serial Number
30890100029
License Number
3010404010100029
License Type / Status
permanent / ok
License Expiration
unlimited
Firmware Version
0404_01_p1
Running Design
505 (DfN3)
  
```

The footer of the interface shows 'IPLink 3.0' and '© Vislink - www.vislink.com'.

Figure 6-49 Assistant Tab

## CHANNEL 1 RESULT –

Troubleshooting assistant which can point out possible issues such as misconfiguration, non-default settings and other device performance issues.

### 6.18.2. Detail-SYS Tab

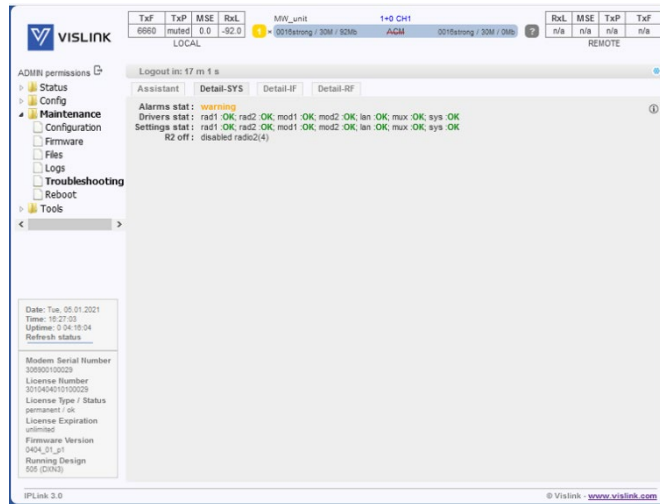

Figure 6-50 Detail-SYS Tab

Device status summary. Additional debug information will be shown in case of error state.

- Alarms stat – Actual device alarm status. Note that only enabled alarms are considered.
- Drivers stat – Actual status of low-level drivers. An eventual error suggests unsuccessful or ongoing communication between respective driver and the system driver. The system driver is responsible for interpretation of device status to front ends (CLI, GUI, SNMP).
- Settings stat – Actual configuration status. An eventual error suggests that a required setting could not be set.

### 6.18.3. Detail-IF Tab

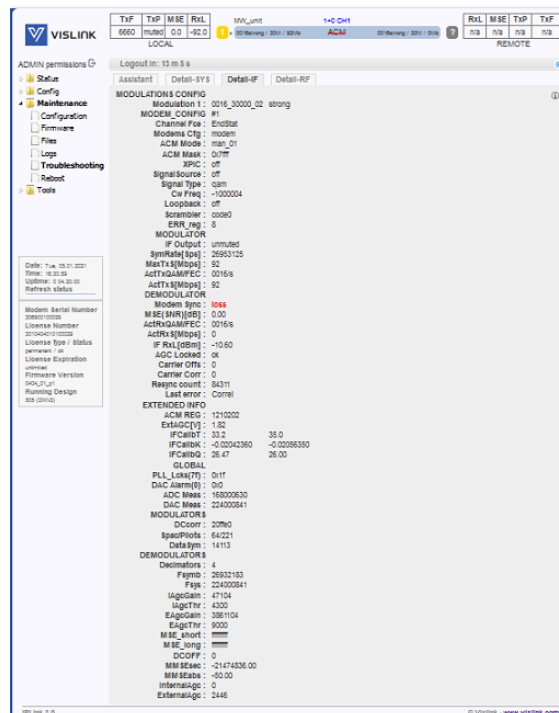

Figure 6-51 Detail-IF Tab

MODULATIONS CONFIG –

This frame provides summary of basic and advanced status details of the IF part.

6.18.4. Detail-RF Tab

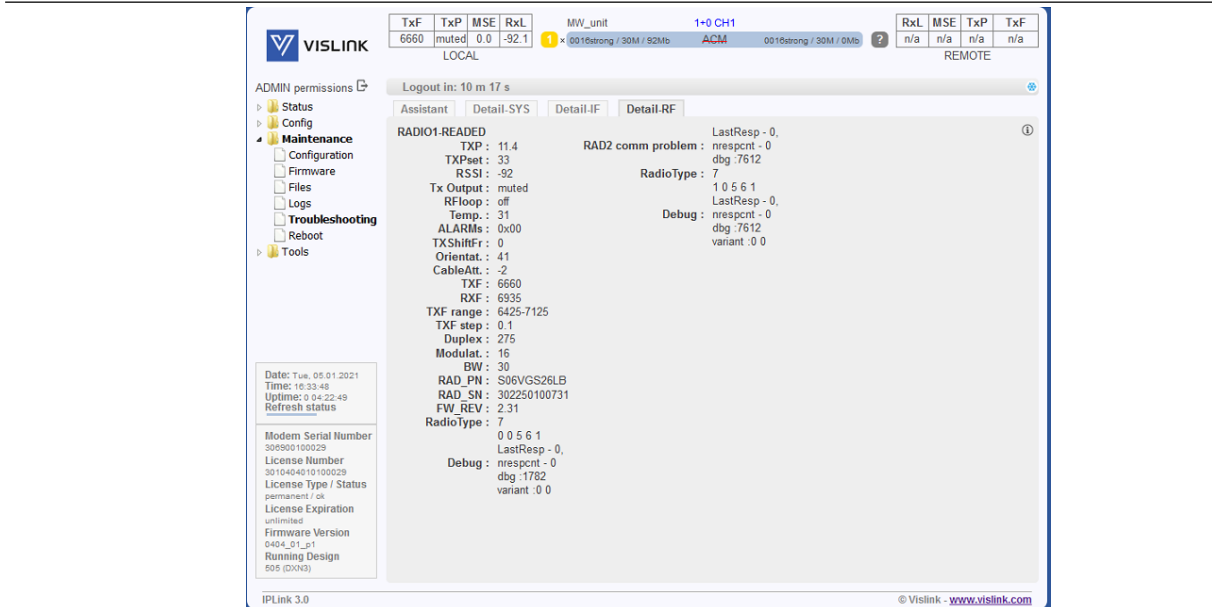

Figure 6-52 Detail-RF Tab

RADIO1-READED –

This frame provides summary of basic and advanced radio parameters. These values are collected directly from respective parts and reflects the actual state of such parts.

6.19. Reboot Page

6.19.1. Reboot Tab

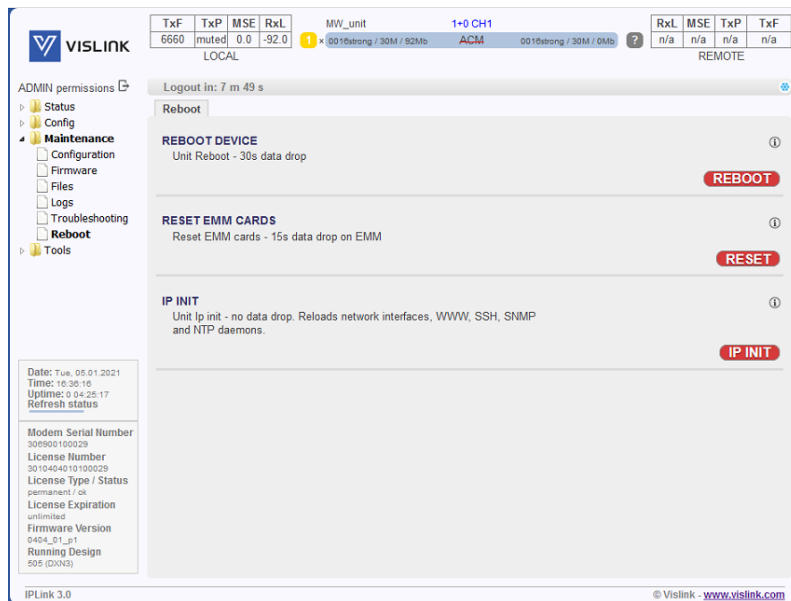

Figure 6-53 Reboot Tab

## REBOOT DEVICE –

After pressing the REBOOT button, the device will perform soft reboot. Please note that this operation will cause data drop.

## RESET EMM CARDS –

After pressing the RESET button, the EMM cards will be initialized. Please note that this operation will cause data drop.

## IP INIT –

After pressing the IP INIT button, the device will perform reinit IP interfaces, SSH, WEB, SNMP and NTP daemons.

## 6.20. Terminal Page

### 6.20.1. Terminal Tab

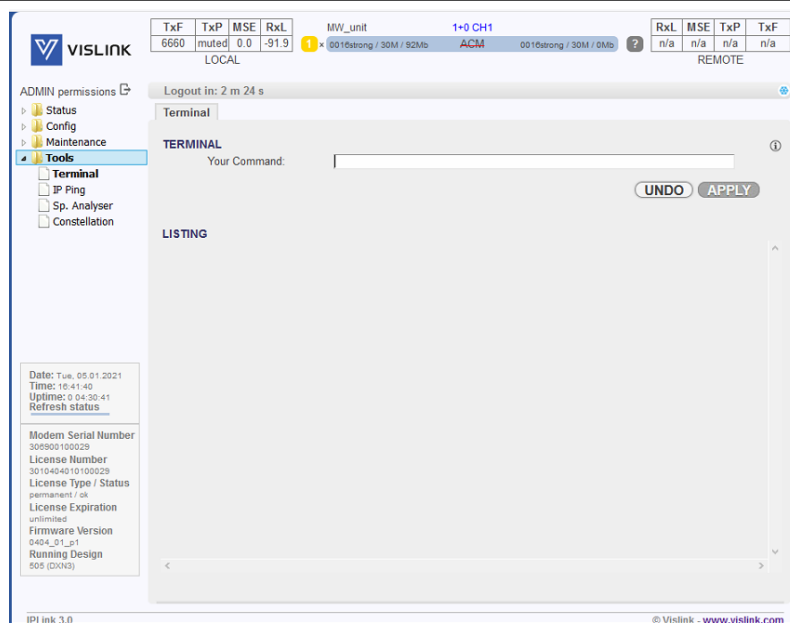

Figure 6-54 Terminal Tab

## TERMINAL –

Inbuilt terminal window for interacting with device's CLI (Command Line Interface) directly from GUI.

For list of all available commands please execute command '?'. Also note that nested commands supports the question mark help as well, for example command 'show ?' will print out all available *show* commands.

## 6.21. IP Ping Page

### 6.21.1. Ping Tab

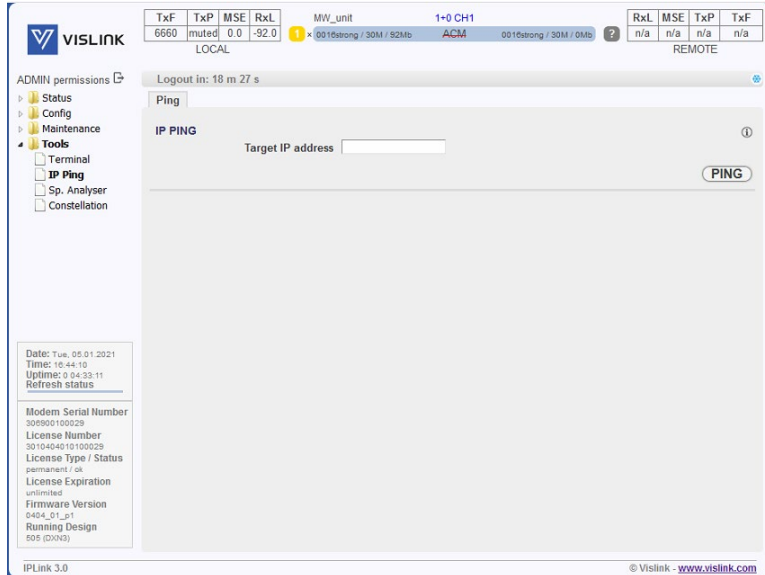

Figure 6-55 Ping Tab

IP PING –

Send ICMP ECHO\_REQUEST to network hosts

- Target IP address – IP address of the host

## 6.22. Sp. Analyzer Page

### 6.22.1. Channel1 Tab

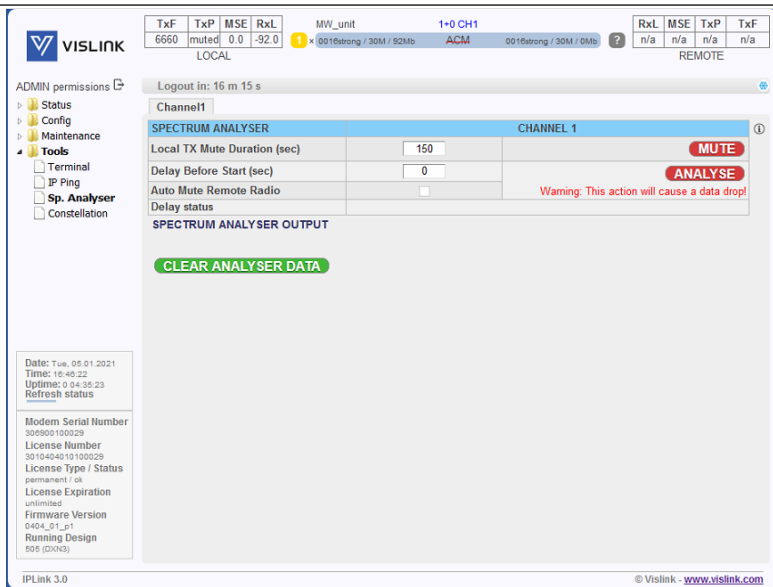

Issue: No.

78

Ref: IPL3-ASUM-8000

Copyright © Vislink

Figure 6-56 Channel1 Tab

## SPECTRUM ANALYSER –

Integrated spectral analyzer for free channel lookup, or alternatively for detection of interference within the particular band.

The frequency scanning consists of 3 automated steps:

- a) local transmitter is muted
- b) local Rx frequency is sequentially tuned from lowest to highest
- c) the local Rx level is recorded for each frequency

This frame consists of two parts:

- SPECTRUM ANALYSER – The spectrum analyzer configuration frame.
  - Local TX Mute Duration – You can use this option to manually mute the local radio for the specified duration. During this period, you should perform the frequency scan on the remote device. This will not invoke the frequency scanning.
  - Delay Before Start – Delay before start of frequency analysis in seconds
  - Auto Mute Remote Radio – Allows auto mute of remote radio if possible (this function requires synchronization with remote side)
  - Delay status – A remaining delay time countdown
- SPECTRUM ANALYSER OUTPUT – The spectrum analyzer output frame. It displays the analyzer results collected since last device reboot.

**Note:** The radio frequency scan can take between 30sec to 2min depending on used radio type and bandwidth. During frequency scanning, there will be data drop.

## 6.23. Constellation Page

### 6.23.1. Channel1 Tab

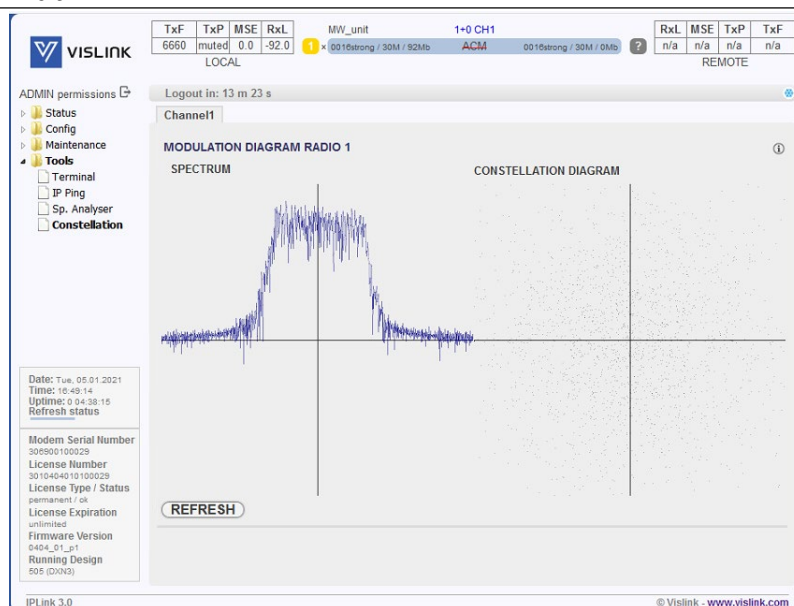

Issue: No.

Ref: IPL3-ASUM-8000

79

Copyright © Vislink

---

Figure 6-57 Channel1 Tab

#### MODULATION DIAGRAM RADIO 1 –

This frame provides actual spectrum and constellation diagram outputs.

- SPECTRUM – A simplified Rx spectrum plot.
- CONSTELLATION DIAGRAM – A representation of a signal modulated by the digital modulation schemes. Two-dimensional scatter diagram in the complex plane at symbol sampling instants. Measured constellation diagram can be used to recognize the type of interference and distortion in a signal.
  - - gaussian noise is displayed as fuzzy constellation points
  - - non-coherent single frequency interference is displayed as circular constellation points
  - - phase noise is displayed as rotationally spreading constellation points
  - - amplitude compression causes points located in the corner to move towards the center



This page is intentionally unused.

## 7. Optional External IPLink Expansion Module

An external 1 RU x 19" rack-mount Expansion Module can provide the addition of ASI and/or E1/T1 channels. There are three different expansion modules available; 4 ASI channels, 16 E1/T1 circuits and 4 ASI channels with 16 E1/T1 circuits. The Expansion Modules are interconnected via the “EMM” optical connector located on the rear panel of the IPLink transceiver and the “SFP” port located on the front panel of the Expansion Module. A maximum of four External Expansion Modules can be interconnected in series to an IPLink radio terminal.

Management of all External Expansion Modules are configured and monitored by the IPLink’s internal management system and accessed via radios GUI.

External Expansion Module units are powered by an external AC to -48 VDC power supply with the GND connected to the positive pole.

### 7.1. E1/T1 IPLink Expansion Module

The IPL-IDU-E1T1-EXPI provides E1/T1 extension for IPLink. The module enables multiplexing up to 16 E1 / T1 circuits. The multiplexer features a basic unit with 16 x E1/T1 built-in ports and 2 x SFP 1000Base-SX ports. Four IPL-IDU-E1T1-EXP Expansion modules can be interconnected together providing up to a maximum of 64 x E1/T1 circuits:

- E1/T1 PORTS – RJ-45 connectors for G.703 signals connection (by default unbalanced)
- SFP 1 UPLINK1 – master SFP port reserved for connection to IPLink or to master Extension module card in Extension module chain
- SFP 2 UPLINK2 – slave SFP port reserved for connection to slave Extension module card in Extension module chain or to relay IPLink in add/drop configuration
- -48 VDC – power supply connector, + pole is grounded inside the device
- Grounding connector

Figure 7-1 and show the pinouts for the 16 E1 user ports.

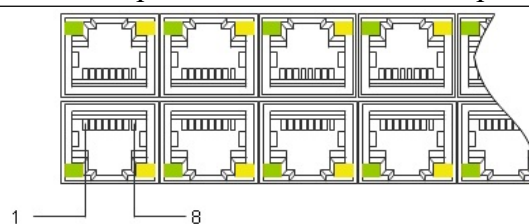

Figure 7-1 E1 User Port Pinout Overview

Pin	Signal
1	Rx-
2	Rx+
4	Tx-
5	Tx+

Table 7-1 EI User Port Pinout

All the ports are protected against ESD (electrostatic discharge), CDE (Cable Discharge Events), and lightning. In case of connecting 16E1 balanced RJ45 interface to your unbalanced BNC E1 interface ports the following cable must be used in conjunction with a shielded RJ45 connector:

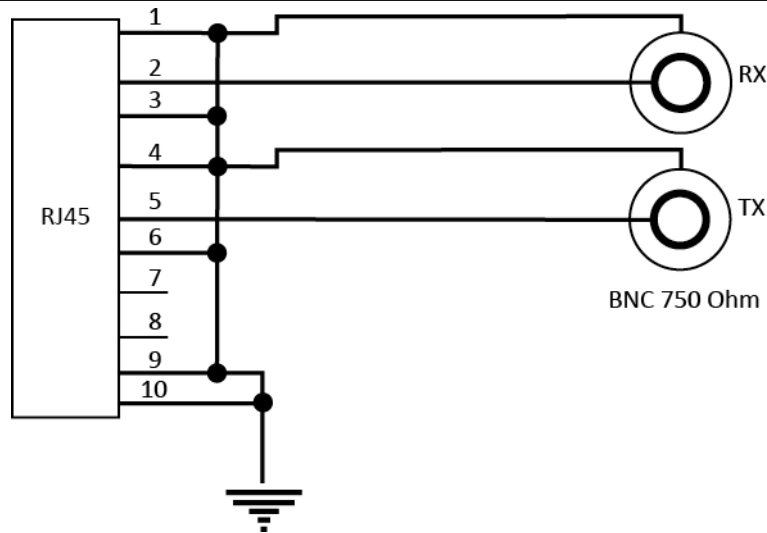

Figure 7-2 RJ45 Ethernet to BNC E1 Cabling Overview

Pinout for this cable is as follows:

Pin	Signal
1	RX ring
2	RX tip
3	GND (over resistor 0805 0R)
4	TX ring
5	TX tip
6	GND (over resistor 0805 0R)
7	NC
8	NC

Table 7-2 RJ45 Ethernet to BNC E1 Cabling Pinout

#### 7.1.1.1. LED Indicators on the IPL-IDU-E1T1-EXP – System Status

- STATUS – indication of the LOCAL Extension module status:
  - Lights – status OK (card enabled, proper communication with IPLink)
  - Flashes – status WARNING (card is not enabled in the system or no communication with IPLink)
  - No light – status ERROR (a firmware is not loaded into Extension module HW)
- POWER – indication that EMM is under power (green LED):
  - Lights – power ON
  - No light – power OFF

### 7.1.2. LED Indicators on the IPLink – IPL-IDU-E1T1-EXP – Port Status

- SFP 1/2 LINK – indication of presented signal at SFP port:
  - Flashes – signal detected and synchronized, valid communication with IPLink
  - No light – no correct signal detected
- LINK – indication of G.703 link status on appropriate port (green LED):
  - Lights – signal detected at port
  - No light – no link at port
- AIS – indication of AIS signal at appropriate G.703 port:
  - Lights – AIS signal detected
  - No light – no AIS at appropriate G.703 port

### 7.1.3. Technical Specification of IPL-IDU-E1T1-EXP Module

Item	Parameter	Details
IPL-IDU-E1T1-EXP	Number of Ports	16 (16xRJ-45)
	Interface	G.703-E1 balanced 120Ω for E1 mode G.703-E1 unbalanced 75Ω for E1 mode T1.102-T1/100Ω for T1 mode
	Specification Compliance	T1.102, AT&T Pub 62411, T1.231, T1.403, ITU-T G.703, G.742, G.775, G.823, ETS 300 166, and ETS 300 233
	Coding	HDB3 for E1 mode, B8ZS for T1 mode
	Speed	2.048 Mbps for E1 mode, 1.554Mbps for T1 mode
	IPLink Direction Interface	1 x SFP 1000 Base-SX (proprietary GIGE protocol) for connection with IPLink
	EXT Module Extension Interface	1 x SFP 1000 Base-SX (proprietary GIGE protocol) for connection with additional EMM module
	EXT Module Scalability	Up to 64 E1/T1 with combination of 4x EMM-16E1/T1 modules in series

Table 7-3 Traffic Interfaces

Item	Parameter	Details
Ports	Main NMS ports	2 x SFP 1000 Base-SX (proprietary GIGE protocol) from IPLink
NMS Form	Protocols	Proprietary
	Management Speed	1Mbps
GUI	Type	Web-based as additional function of IPLink
SNMP	Version	SNMP v1, SNMP v2c, SNMP v3 IPLink support
	Read access	Complete MIB IPLink support
	Write access	Sub-set of link parameter IPLink support
Security	Licenses	Time limited/permanent IPLink Support
	Access levels	Guest/User/Admin with password security IPLink Support

Table 7-4 Network Management System

Item	Parameter	Details
Mechanical	Dimensions	224mm (width) x 44mm (height) x 134mm (depth)
	Weight	1.3kg
	Protection	EN 60529 (IP31)
Input Voltage Level	EMM only	-20 VDC up to -60 VDC (standard version)
Power Consumption	IPLink-16 x E1/T1-EXT	< 9 W
Environmental Operational Conditions	Temperature	-5°C to +45°C
	Humidity	0 to 95%, non-condensing
	Altitude	4,500 meters
Compliance	Operation	ETSI EN 300 019, Part 1-3, Class 3.2
	Storage	ETSI EN 300 019, Part 1-1, Class 1.2
	Transportation	ETSI EN 300 019, Part 1-2, Class 2.3
	Power	EN 300 132-2
	EMC	EN 55022 class B, EN 61000-4-2,3,4,5,6,8,11 EN 61000-3-2,3
	Safety	IEC 60950-1/EN 60950-1

Table 7-5 Miscellaneous

## 7.2. Integrated ASI Module – IPL-IDU-ASI-EXP

This option provides ASI functionality for IPLink. The integrated IPLink-ASI-EXT card enables multiplexing up to four additional ASI channels.

The real overall capacity for ASI is allocated in the PBPS based on true selected ASI ports using the IPLink Web interface. Priority Base Packet System (PBPS) is proprietary multiplexer system.

IPL-IDU-ASI-EXPEach ASI channel can be independently configured into TX or Rx mode. ASI Rx is from the perspective of the radio, e.g. ASI into the device. ASI TX is transmitted from the device. Following port combinations are available by this setting:

- 4x ASI TX (unidirectional)
- 3x ASI TX, 1x ASI Rx (bidirectional)
- 2x ASI TX, 2x ASI Rx (bidirectional)
- 1x ASI TX, 3x ASI Rx (bidirectional)
- 4x ASI Rx (unidirectional)

The Priority Base Packet System (PBPS - proprietary multiplexer system) is used for 1 up to 4 ASI channels multiplexing. The data PBPS stream is first completed with management data channel for communication with the connected IPLink and subsequently is packed into standard Ethernet frame. The PBPS packets from IPLink-ASI-EXT are then combined with another PBPS packets from internal data sources (Ethernet) assembled on IPLink according to default priority scheme.

### 7.2.1. Technical Specification for IPL-IDU-ASI-EXPEXT

Item	Parameter	Details
IPL-IDU-ASI-EXP	Number of Traffic Ports	4 (4 x BNC)
	Interface	Unbalanced 75Ω
	Tx Output Voltage (p-p)	800 mV
	Min Rx. Sensitivity	200 mV (for D21.5 idle pattern)
	Specification Compliance	DVB-ASI, EN/ISO/IEC 13818-1, ETS 300 429
	Coding	8B/10B, MPEG-2 TS
	Port Speed	270 Mbps at BNC port
	Max. speed for ASI channel	216 Mbps
	ASI channel shaping	8-216 Mbps
	Packet format	188 bytes/204 bytes (with FEC)

Table 7-6 Traffic Interfaces

Item	Parameter	Details
Mechanical	Dimensions	224mm (width) x 44mm (height) x 134mm (depth)
	Weight	1.3kg
	Protection	EN 60529 (IP31)
Input Voltage Level	IPLink-EXT only	-20 VDC up to -60 VDC (standard version)
Power Consumption	IPLink-ASI-EXT	< 9 W
Environmental Operational Conditions	Temperature	-5°C to +45°C
	Humidity	0 to 95%, non-condensing
	Altitude	4,500 meters
Compliance	Operation	ETSI EN 300 019, Part 1-3, Class 3.2
	Storage	ETSI EN 300 019, Part 1-1, Class 1.2
	Transportation	ETSI EN 300 019, Part 1-2, Class 2.3
	Power	EN 300 132-2
	EMC	EN 55022 class B, EN 61000-4-2,3,4,5,6,8,11 EN 61000-3-2,3
	Safety	IEC 60950-1/EN 60950-1

Table 7-7 Miscellaneous

This page is intentionally unused.



## 8. Optional External High Power Amplifier

The range of the IPLink’s transmission may be increased by use of the IPLink DHPA (rack mounted digital power amplifier). The DHA boost the power by 8dB nominal (up to 12.5W linear output power) providing long range transmissions of up

### 8.1. Front Panel Overview



to 100km.

Figure 8-1 Optional External DHPA Front Panel Overview

#### 8.1.1. Power Switch

System power on/off – when lit, power is applied to the transceiver.

#### 8.1.2. LEDs

On power up the three LEDs will flash orange twice to act as a visual confirmation that the LEDs are working. If all three LEDs remain off the supply, PSU or other hardware has failed.

After initialisation the LEDs will indicate the following:

State	Description
Red (slow flash)	Unit waiting for operational setup (control input)
Orange (slow flash)	Unit waiting for stable RF input power to be present
Green	RF input in range
Red	Unit could not achieve RF output level or hardware failure

Table 8-1 RF-In LED

State	Description
Red	RF output level out of range
Orange (slow flash)	Unit adjusting RF output level
Green	RF output in range
Red (quick flash)	Unit could not achieve RF output level or hardware failure

Table 8-2 RF-Out LED

State	Description
Green	Bypass active – unit not amplifying RF
Off	Bypass not active – unit amplifying RF
Red	Bypass relay failure – relay status does not match command value

Table 8-3 Bypass LED

## 8.2. Rear Panel



Figure 8-2 Optional External HP Amp Rear Panel Overview

### 8.2.1. AC Power

Provides AC power to the unit.

### 8.2.2. USB

USB type B connector for software upgrades.

### 8.2.3. Remote (9-Pin D-Sub Type Female)

This connector is currently only used for factory configuration.

### 8.2.4. IPLink (9-Pin D-Sub Type Male)

This connector is used for communicating with an external DHPA (rack mounted PA).

Pin	Signal
1	NC
2	RS282 TX
3	RS282 RX
4	NC
5	GND
6	NC
7	NC
8	NC
9	NC

Table 8-4 9-pin D-sub Pinouts

### 8.2.5. RF Out

SMA 50Ω female connector – RF signal out to antenna.

### 8.2.6. RF In

SMA 50Ω female connector – RF signal in from IPLink.

## Appendix A Safety Information

IPLink complies with the basic requirements of European R&TTE Directive 1999/5/EC Article 3 and meets the requirements contained in the harmonized standards R & TTE, in accordance with article 5 of the directive. IPLink complies also with the basic requirements of FCC rules according to the table below.

Essential requirements under Article 3	Harmonized standards under Article 5
Article 3.1 (a): Protection of health and safety of users (contained requirements of Directive 73/23/EEC and council recommendation 1999/519/EC)	EN 60950-1 (2006) EN 50 385 (2002)
Article 3.1 (b): Electromagnetic compatibility (contained requirements of Directive 2004/108/EC)	ETSI EN 301 489-1 V 1.6.1(2008) ETSI EN 301 489-4 V1.3.1(2002)
Article 3.2: Requirements for effectively use the frequency spectrum	ETSI EN 302 217-1 V1.2.1 (2007)

Table A-1 Requirements and Harmonized ETSI standards

Essential requirements	Standards
US FCC limits	System has been tested for compliance with FCC Part 74, Part 101 and the General requirements of Part 2. The limits for digital devices pursuant to Parts 15.107 and 15.109 Class A has been applied.

Table A-2 Requirements and Harmonized FCC Standards

The IPLink product complies with the basic requirements for this type of equipment and all of the above technical standards. Operation of equipment is safe under normal conditions of use set out in this User Guide.

NOTE: Modifying or tampering with IPLink’s internal components can cause a malfunction and might invalidate its warranty.

The IPLink is a fixed transceiver. This unit, operated without an antenna, will not create RF energy exceeding 1.0 mW/cm<sup>2</sup>, the FCC limit for exposure. Once connected to an antenna, the potential for harmful exposure will be greatly enhanced.

In this situation, a certain distance from the radiator is to be maintained. Calculations need to be performed to understand what that safe margin for exposure is. This is known as the Maximum Permissible Exposure (MPE) limit.

NOTE: Hazardous RF radiation limits and recommended distances may vary by country. Ensure that all applicable state and federal regulations are observed when using this transmitter.

Calculations provided are for common antennas often utilized in the ENG environment. The following formula used is that suggested by OET 65.

Table A-3 shows the MPE minimum safe distances from the antenna.

Antenna Gain (dBi)	0	2	3	5	11
Safe Distance (cm)	2	2	2	3	5
Safe Distance (inch)	0.79	0.79	0.79	1.18	1.97

Table A-3 MPE Minimum Safe Distances

Vislink, in accordance with the requirements set forth by the FCC, provides this information as a guide to the user. It is assumed that the users of this equipment are licensed and qualified to operate the equipment per the guidelines and recommendations contained within the product user guides and in accordance with

### A.1. Calculating MPE

any FCC rules that may apply.

$EIRP = P * [10(G / 10)] = (\text{AntiLog of } G/10) * P$   
 $P = \text{RF power delivered to the antenna in mW}$

$G = \text{Power gain of the antenna in the direction of interest relative to an isotropic radiator}$   
 $R = \text{distance to the centre of radiation of the antenna in centimetres}$   
 $S = \text{MPE in mW/cm}^2 \text{ (milliwatts per square centimetres)}$

#### A.1.1. Conversions

$\text{dBi to numeric gain} = \text{AntiLog}(\text{dBi}/10)$   
 $\text{Feet to centimetres} = \text{Feet} * 30.48$   
 $\text{Centimetres to Feet} = \text{cm} * 0.0328$   
 $4\pi = 12.57$

#### A.1.2. User Input

$\text{RF power delivered to the antenna} = \text{Watts}$   
 $\text{Antenna gain (referenced to isotropic antenna)} = \text{dBi}$   
 $\text{Distance from the centre of radiation} = \text{Feet}$

#### A.1.3. Calculation Steps

1. [P] RF power input. Watts to milliwatts = Watts \* 1000
2. [G] Antenna gain dBi. Numeric gain = AntiLog (dBi/10)
3. [EIRP] Multiply P \* G
4. [R] Centimeters to feet = Centimeters \* .0328
5. Square R
6. Multiply  $R^2 * 4\pi$
7. [S] Divide  $(R^2 * 4\pi)$  into EIRP
8. Power Density in milliwatts per square centimeters

NOTE: At frequencies above 1500 MHz, S must not be greater than 1.

#### A.1.4. Reference

FCC OET Bulletin 65, August 1997 - Evaluating Compliance with FCC Guidelines for Human Exposure to Radio Frequency Electromagnetic Fields.

The following tables show the permissible exposure distance for various antennas. Data will vary based on the actual transmitter, output power, frequency, and antenna utilized. One table provides the permissible output of the transmitter for low-power digital modulation, and the other table for high-power digital modulation.

This information is provided, in accordance with the requirements set forth by the FCC, as a guide for you assuming that users of this equipment are licensed and qualified to operate the equipment per the guidelines and recommendations contained within the product user guides and in accordance with any FCC rules that

#### A.1.5. Low Power may apply.

Antenna Gain (dBi)	0	29	36	40	43
Minimum Safe Distance from Antenna (cm)	9	252	563	893	1261
Minimum Safe Distance from Antenna (inch)	3.54	99.19	221.60	351.48	496.33

Table A-4 MPE Low Power Minimum Safe Distances

#### A.1.6. High Power

Antenna Gain (dBi)	0	29	36	40	43
Minimum Safe Distance from Antenna (cm)	13	356	797	1262	1783
Minimum Safe Distance from Antenna (inch)	5.12	140.12	313.70	496.72	701.79

Table A-5 MPE High Power Minimum Safe Distances

This page is intentionally unused.

## Appendix B Payload Capacity, Bitrates & TX Power

### B.1. IPLink RF Output (Before Branching Filtering)

TX Power (+/- 1dBm) across Frequency Band.

RF Output Range	Modulation	RF Module Output
6.425 – 7.125 GHz	QPSK	+33 dBm
	16 QAM	+32 dBm
	32 QAM	+31 dBm
	64 QAM	+30 dBm
	128 QAM	+30 dBm
	256 QAM	+29 dBm
	512 QAM	+28 dBm
	1024 QAM	+25 dBm
6.425 – 7.125 GHz	QPSK	+33 dBm
	16 QAM	+32 dBm
	32 QAM	+31 dBm
	64 QAM	+30 dBm
	128 QAM	+30 dBm
	256 QAM	+29 dBm
	512 QAM	+28 dBm
	1024 QAM	+25 dBm
7.725 – 8.500 GHz	QPSK	+32 dBm
	16 QAM	+31 dBm
	32 QAM	+30 dBm
	64 QAM	+29 dBm
	128 QAM	+29 dBm
	256 QAM	+28 dBm
	512 QAM	+27 dBm
	1024 QAM	+24 dBm
13.000 GHz	QPSK	+28 dBm
	16 QAM	+27 dBm
	32 QAM	+26 dBm
	64 QAM	+25 dBm
	128 QAM	+25 dBm
	256 QAM	+24 dBm
	512 QAM	+23 dBm
	1024 QAM	+20 dBm

Table B-1 RF Module Output

## B.2. Bit Rates Transmission Power for IPLink

Data throughput include strong LDPC forward error correction overhead.

Bandwidth	Modulation	L6GHz	U6GHz	7GHz	8GHz	11GHz	13GHz	18GHz	23GHz	Capacity,Mbps
25	4QAM StrongFEC	84.5	-85.0	-83.5	-84.5	-85.0	-84.5	84.0	-84.5	37.0
25	16QAM StrongFEC	78.0	-79.0	-78.0	-78.0	-78.0	-78.0	78.0	-78.0	74.0
25	32QAM StrongFEC	75.0	-75.5	-75.0	-75.0	-75.5	-75.0	75.0	-75.0	93.0
25	64QAM StrongFEC	72.0	-73.0	-72.0	-72.0	-72.0	-72.0	71.5	-72.0	111.0
25	128QAM StrongFEC	69.0	-70.0	-69.5	-69.0	-69.0	-69.0	69.0	-69.5	130.0
25	256QAM StrongFEC	66.5	-67.0	-66.5	-64.5	-66.0	-66.0	66.0	-66.5	148.0
25	512QAM StrongFEC	63.5	-64.0	-63.0	-61.5	-63.0	-62.5	63.0	-63.5	167.0
25	1024QAM StrongFEC	60.0	-61.0	-60.0	-58.5	-59.5	-59.5	59.5	-59.5	186.0
30	4QAM StrongFEC	83.5	-84.0	-82.5	-83.5	-83.0	-83.5	83.5	-84.5	45.0
30	16QAM StrongFEC	77.0	-78.0	-77.5	-76.5	-76.5	-77.0	77.0	-77.5	91.0
30	32QAM StrongFEC	74.0	-75.0	-74.0	-73.5	-74.0	-74.0	74.5	-74.5	114.0
30	64QAM StrongFEC	71.0	-72.0	-71.5	-71.0	-70.5	-71.0	70.5	-71.5	137.0
30	128QAM StrongFEC	68.5	-69.5	-68.5	-68.0	-68.0	-68.0	68.0	-69.0	160.0
30	256QAM StrongFEC	65.5	-66.0	-66.0	-63.5	-64.5	-65.0	64.5	-66.0	183.0
30	512QAM StrongFEC	62.5	-63.0	-61.5	-60.5	-61.5	-61.5	61.5	-62.5	206.0
30	1024QAM StrongFEC	59.0	-59.5	-59.5	-57.5	-58.5	-58.5	59.0	-58.5	229.0

Table B-2 Channel Bandwidth only for 25MHz and 30MHz

Note: Contact Vislink for fill listing



## Appendix C Configuration Notes

This appendix provides examples of typical configurations that can be used to begin data transmission from local to remote IPLink transceivers

### C.1. Introduction

After the installation of the microwave link itself, it is necessary to carry out the complete set-up of all the required link parameters including IP management settings. It is recommended to write these parameters such as IP addresses, TX frequency, TX power, etc., in advance into a well-arranged table. Save this data list (using the Write Button), in case of a later replacement of a unit, so that a previous configuration can be restored easily.

- ⚠ CAUTION: Do not use the browser functions back or page refresh during the set-up or for viewing a previous window. Use only the Main menu, submenu folders and Web interface buttons of IPLink transceiver.

### C.2. Connection and Login

#### C.2.1. Local Access over Ethernet LAN Interface

To setup the IPLink via the management LAN port (see Section 3.2 **Error! Reference source not found.**) create a connection between the IPLink and the PC to be used for configuration, via an Ethernet cable to the RJ45 connector on the

#### C.2.2. Login from the Web Interface front panel.

Before attempting to connect to the unit from a PC it will be necessary to configure the computer's network connection. The secondary IP address for access via LAN port is set by default to 10.10.10.10/8 (network mask 255.0.0.0).

After configuring the computer's network connection, a Web browser can be launched. Enter the secondary IP address of IPLink, i.e. 10.10.10.10, into the address bar of the Web browser (example for connection over MNG LAN port). Once the browser has found the unit the Login page will be displayed (see Section 6.1).

The login into the device is active until the logout of the device is performed. As such, it is not possible to configure the local IPLink from two terminals at the same time (only one terminal could be in the set-up mode at one moment). It means just one user with User or Administrator rights can be logged in.

There is an automatic timeout in the device – after period of 10 minutes of inactivity (in the Web environment) any user is automatically logged out.

For the standard configuration we recommend to login in the User mode. Administrator level is superior to the User level. When the Administrator tries to login the system and the User is already in the system, an alert window asks if the Administrator wants to force the logout of the User (as only one connection is allowed at a time, as described above).

### C.3. General System Configurations

#### C.3.1. Info Page

It is recommended to fill in the General tab – Info page (see Section 6.3.4) table with complete link identification. This will be helpful for the next system description.

#### C.3.2. Date Page

It is recommended to accurately set the Date and Time information in the General tab – Date page (see Section 6.3.6) for all IPLink systems within the microwave network. This will be helpful especially for alarm event and log analysis.

#### C.3.3. Access Rights

It is possible to monitor and manage the microwave link IPLink after the login into the system only, both locally and remotely. Dependent on the login level (after entering a Login and a Password) the relevant access rights are automatically granted to the user, which affect the scope of the management capabilities for the microwave link. These login levels must be respected both in access from Web interface as well as from a Telnet, SSH or SNMP connections. It is recommended to change default login names and passwords for access into managed networks, which may be configured via the General tab – Users page (see Section 6.3.7).

#### C.3.4. Alarm Configuration

A proper alarm configuration helps to effectively solve potential troubleshooting events and/or disclose any system instability. From the configuration point of view all of the most important alarm settings are available from the Web interface under the Alarms tab – Configuration and Status page (see Section 6.4.1).

### C.4. Radio Configuration

The basic Radio configuration is available from the Web Interface Radio Tab – Parameters page (see Section 6.5.1). Parameters for both local and also for a remote unit can be set together in one configuration step when appropriate boxes for local and remote unit are edited.

The modulation scheme settings and the channel bandwidth affect the final data rate (data throughput) and sensitivity (link distance) of the microwave link. Generally speaking, the narrower the bandwidth and the lower the modulation are, then the lower the data rate but greater the sensitivity will be.

Dependent on the type of supplied license (limit for maximum data rate) the modulation type can be changed (type of modulation can be adjusted or changed up to a maximum transmission capacity). Microwave link can be ordered with the different licenses in accordance with actual price list and business policy. The transmission capacity can then be changed in the range of 10 Mbps up to a maximum data rate of supplied license, maximum 365 Mbps for 1+0 mode.

The microwave link can be supplied with a higher type of modulation (with higher data rate) for a limited period via a time-restricted license, e.g. for temporary

testing. After the expiration of this period the maximum type of modulation is automatically downgraded to the default modulation from license and the user data transmission capacity is disabled (0 Mbps). It will not affect the out-of-band management channel.

The modulations are named according to the combination of the following parameters. Behind the modulation code, there is written the overall Capacity – real data throughput. Modulation name coding is described in the following example.

Example: 128\_28000\_01:

- 256 – code for 256 QAM, other possibilities are 4/8/16/32/64/128/256
- 56000 – code for 56 MHz bandwidth, other possibilities are:
  - 07000, 10000, 14000, 20000, 27500, 28000, 30000, 40000, 50000, 56000, 60000
- 01 – code for modulation version

Any change must be finally confirmed with pressing the Apply button. All the basic parameters can be configured for local and remote terminal from this page when the proper connection is established. Save all changes and configurations by selecting the Write button.

## C.5. Port Configurations

### C.5.1. Design Mode – Single

Port settings in Single mode use the simplest configuration scheme, as just one independent traffic channel is available for configuration. The internal ETH switch is divided into two separate groups. Group 1 is reserved for management purposes (out of band type of management) and Group 2 is generally designated for traffic purposes.

The customer can use up to three LAN ports (SFP 1, LAN 1, LAN 2) for traffic connection into and allocate the maximum speed for ETH traffic over RF link.

### C.5.2. Design Mode – Multi

Port settings in Multi-mode offer an option to select up to four independent over air traffic channels. The internal ETH switch is divided into three separate groups. Group 1 is usually reserved for management purposes (out of band type of management), Group 2 is designated for the first traffic channel (the lowest priority), and Group 3 is designated for the second traffic channel (higher priority).

The other two traffic channels are connected directly to SFP PHYs, so no ETH switch is the part of such LAN interconnection. Traffic channel ETH 4 has the highest priority inside the packet processor structure.

The Speed Allocation set-up is different in comparison with Single mode. The overall allocated traffic capacity (the sum of all ports capacity) should be in the range of available speed for actual modulation scheme. When the adaptive modulation mode (ACM) is enabled, then the user must consider which lower priority channels do not need the free capacity allocation in the case of switch to

lower level modulation scheme. priority channels do not need the free capacity allocation in the case of switch to lower level modulation scheme.

### C.5.3. Design Mode – Protected 1+1

Port settings for Protected 1+1 mode are like Multi mode, but only three independent over air traffic channels are available. Port SFP 1 is reserved for protection function (interconnection with neighbor).

There also exists a difference between master and slave units. All standard traffic ports (LAN 1, LAN 2, SFP 2) are automatically disabled (DOWN) at slave unit. This prevents from the multipath Ethernet loops. The same ports are also disabled when protection mode is configured into off mode.

### C.5.4. Design Mode – Aggregate 2+0

Port settings for Aggregate 2+0 mode are different for master and slave units. Traffic port SFP 1 and channel ETH-1 at master unit are reserved for the aggregation function, next two channels ETH-2 can be used for next independent traffic streams.

The channel ETH-2 at the slave unit is reserved for the slave aggregation stream (correct speed must be set); other ETH channel (ETH 1) is available for next independent data source.

### C.5.5. ETH VLAN Settings

VLAN configuration is basically used for the separation of management traffic from other customer data traffic. It can be useful to configure ETH VLANs also for customer traffic and filter ingress data traffic by means of these settings in some specific applications. See Ports tab – ETH VLAN page (see Section 6.6.2).

## C.6. ETH Advanced Settings

### C.6.1. QoS Ethernet Setting

This section makes it possible to configure extended QOS modes which are important for a specific traffic prioritization. The system uses four priority queues for each port where frames, with an assigned initial frame priority, an initial queue priority and an override queue priority, are mapped onto four output queues according to QPRI settings. A final frame queue priority is derived from the assigned initial queue or the override queue priority and it is used for deciding what queue will be used for frame buffering. The queue with a higher number is egressed with higher priority than the queues with lower numbers. The assigned initial frame priority is then used for replacing of frame's PRI bits in 802.3ac VLAN tag section, when the frame is egress tagged.

### C.6.2. Priority Abbreviations

- FPRI – initial frame priority 0 up to 7 (bits [2:0])
- QPRI – queue priority 0 up to 3 (bits [1:0])
- IQPRI – initial queue priority 0 up to 3 (bits [1:0])
- OQPRI – queue override priority 0 up to 3 (bits [2:1] from QOS PRI value)
- PRI\_T – PRI bits from 802.ac VLAN tag
- PRI\_IP – hex value of IP v4/6 frame's TOS/DiffServ/TC bits [7:2]

### C.6.3. Port Default Priority

- FPRI\_D – port default frame priority, defined with Port Priority value
- QPRI\_D – port default queue priority, defined with next mapping table:
  - QPRI\_D – 0 when FPRI\_D=0/1
  - QPRI\_D – 1 when FPRI\_D=2/3
  - QPRI\_D – 2 when FPRI\_D=4/5
  - QPRI\_D – 3 when FPRI\_D=6/7

### C.6.4. IEEE Tag Priority

- FPRI\_T – IEEE Tag frame priority, defined with value of PRI bits from VLAN tag
- QPRI\_T – IEEE Tag queue priority, defined with next mapping table:
  - QPRI\_T – 0 when FPRI\_T=0/1
  - QPRI\_T – 1 when FPRI\_T=2/3
  - QPRI\_T – 2 when FPRI\_T=4/5
  - QPRI\_T – 3 when FPRI\_T=6/7

### C.6.5. IP v4/6 Priority

- FPRI\_IP – IPv4/6 frame priority, defined with following figure:
  - $FPRI\_IP = QPRI\_IP * 2 + FPRI\_D[0]$
  - or, defined in another way:
  - $FPRI\_IP[2:1] = QPRI\_IP[1:0]$
  - $FPRI\_IP[0] = FPRI\_D[0]$
  - QPRI\_IP – IPv4/6 queue priority, defined with next mapping table (hex values)
- QPRI\_IP – 0 when PRI\_IP=00/04/08/0c/10/14/18/1c/20/24/28/2c/30/34/38/3c:
  - QPRI\_IP – 1 when PRI\_IP=40/44/48/4c/50/54/58/5c/60/64/68/6c/70/74/78/7c
  - QPRI\_IP – 2 when PRI\_IP=80/84/88/8c/90/94/98/9c/a0/a4/a8/ac/b0/b4/b8/bc
  - QPRI\_IP – 3 when PRI\_IP=c0/c4/c8/cc/d0/d4/d8/dc/e0/e4/e8/ec/f0/f4/f8/fc

### C.6.6. Priority Policy

This setting in the Ports tab – ETH Advanced page (see Section 6.6.4) defines the initial ingress queue policy. It defines the initial rules for what output queue will be assigned to every ingress frame.

The following rules are in place for priority assignment (from the top to the bottom order):

#### 9. All:

- Tagged IPv4/6 frames:
  - IQPRI = QPRI\_T
  - FPRI = FPRI\_T
- Tagged non IPv4/6 frames:
  - IQPRI = QPRI\_T
  - FPRI = FPRI\_T
- Untagged IPv4/6 frames:
  - IQPRI = QPRI\_IP
  - FPRI = FPRI\_IP
- Untagged non IPv4/6 frames:
  - IQPRI = QPRI\_D
  - FPRI = FPRI\_D

#### 10. Port only:

- All frame types:
  - QPRI = QPRI\_D
  - FPRI = FPRI\_D

#### 11. Tagged only:

- tagged frames:
  - IQPRI = QPRI\_T
  - FPRI = FPRI\_T
- untagged frames:
  - QPRI = QPRI\_D
  - FPRI = FPRI\_D

#### 12. IPv4/6 only:

- IPv4/6 frames:
  - IQPRI = QPRI\_IP
  - FPRI = FPRI\_IP
- Non-IPv4/6 frames:
  - IQPRI = QPRI\_D
  - FPRI = FPRI\_D

### C.6.7. Firmware and License Upgrade

Firmware and license upgrade is available only when logged in as an ADMIN user. We recommend verification of the loaded version of firmware in the unit before upgrading or updating the license of microwave link. It is possible that the older firmware does not recognize the new designs, options or functions contained in new license key and will not run properly.

Both Firmware and License upgrade are available from the Maintenance Tab – Upgrade Page (Section 6.9.4) and use the same update process.

### C.6.8. License Upgrade

Proper license file must be selected and confirmed by OK button. Upgrade process is then monitored via the processing window. New license is active after one of next events:

- New license is checked by selection of the General/License page.
- New modulation is selected.
- When periodical license update loop is over (once per 6 hours).

### C.6.9. Firmware Upgrade

Firmware is divided into four sections dependent on their functions. For every firmware release it is not necessary to update all the parts, but only these ones that are different compared to the latest version. There is basic firmware parts description in the following text:

- hwbase.afw – software for internal HW parts
- oskernel.afw – operating system
- dev.afw – drivers for OS
- fwbase.afw – application software (Web, SNMP,

commands, etc.) Assistance packages are also contained in every firmware release:

- checkversions.afw – this package compares the firmware version in the unit with the newest version and prints the information about which parts are necessary to upload.
- fw\_all.afw – this package compares the current version of firmware in the unit with the newest version and then automatically uploads the different parts.



### C.6.11. Recommended Steps for Firmware Update

1. Login to the Web interface as an ADMIN user.
2. Save currently running configuration by selecting the Write Button, which is available on each Web interface page.
3. Compare currently running versions of each firmware parts (os\_kernel, os\_dev, hw\_base and fw\_base) with the newest version by one of two below given steps:
  - a. manually compare data shown in General Tab – Info Page with the new version of description file version.txt
  - b. go to Maintenance Tab – Upgrade Page, select package checkversions.afw and use the print-out for information, what parts should be upgraded.
4. Next choose one of the following steps.
  - c. select the file fw\_all.afw from the provided SW package. The entire file will be uploaded into the device, system compares the different versions and writes the different parts of the firmware into flash memory.

NOTE: This procedure is not suitable for slow access to management.

- d. Step by step select the files hwbase.afw, oskernel.afw, dev.afw and fwbase.afw in this order (if there is not necessary to upload any part, please continue with another file) and wait for the process completion.
5. After the last file is uploaded, restart the device by clicking the Reboot button, available from the Maintenance Tab – Advanced Page.

NOTE: During restart there is a data drop for about twenty seconds.

6. Login again as an ADMIN user and update start-up memory configuration with the new functional settings available in the new firmware. Save the new configuration with Write Button, which is available on each page.
7. Make a new initialization from the start-up memory by selecting Run\_W0 button found in the Maintenance Tab – Configuration Page.

NOTE: During initialization there is data drop of about five seconds.

## Appendix D Abbreviation List

Abbreviation	Description
AGC	Automatic Gain Control (on RF cable)
ANSI	American Standards Association
AIS	Continual sequence of ones on E1 data according to norm
ANEG	Auto-Negotiation – automatic speed and duplex set-up on LAN ports
ASI	<p>Asynchronous Serial Interface is a streaming data format that often carries an MPEG Transport Stream (MPEG-TS). An ASI signal can carry one or multiple SD, HD or audio programs that are already compressed, not like an uncompressed SD-SDI (270 Mbit/s) or HD-SDI (1.485 Gbit/s).</p> <p>An ASI signal can be set at varying transmission speeds and is dependent on the engineering requirements. For example, an ATSC (US digital standard for broadcasting) has a maximum bandwidth of 19.392658 Mbit/s. Generally, the ASI signal is the final product of video compression, either MPEG2 or MPEG4, ready for transmission to a transmitter or microwave system or other device. Sometimes it is also converted to fibre, RF or SMPTE310 for other types of transmission. There are two transmission formats commonly used by the ASI interface; the 188-byte format and the 204-byte format. The 188-byte format is the more common ASI transport stream. When optional Reed–Solomon error correction data are included, the packet can stretch an extra 16 bytes to 204 bytes total.</p>
ATPC	Automatic control of output power at RFU on the basis of Rx level at remote unit
ATU	Table of MAC addresses
BER	Bit Error Rate
DHPA	Digital High-Power Amp
EFS	Error Free Seconds
EMM	<p>External Multiplexer Module (or the Extension card IPLink-ASI-EXT), provides ASI extension for IPLink. The IPLink-ASI-EXT card enables multiplexing up to four ASI channels into compact stream that is directed over Fibre optic connection to/from IPLink. The multiplexer features a basic unit with 4 x ASI built-in ports (one BNC per ASI channel) and 2 x SFP 1000Base-SX ports.</p> <p>The compact, simple to configure, and easily scalable design enables cascading with other IPLink extension devices (e.g. IPLink-16E1/T1-EXT). Use the IPLink Web interface to configure cascading IPLink system.</p> <p>The real overall capacity for ASI is allocated in the PBPS based on true selected ASI ports in the Web interface of IPLink. Priority Base Packet System (PBPS) is proprietary multiplexer system.</p>
EMM alarm	This alarm state indicates that the indicated expansion module is disconnected or powered off.
ERS	Error seconds
ETSI	European Telecommunications Standards Institute
FER	Frame Error Rate (per minute)
HWADDR	MAC address of Ethernet interface
MDIX	Configuration for wires crossover on LAN ports

Abbreviation	Description
MSE	<p>Dispersion of dots from ideal location in I/Q diagram after demodulation. The sharper the dots of status diagram are the better (value should be in interval -40 to -32dB). MSE thresholds for each modulation with bandwidth 28MHz are:</p> <p>128QAM -24 dB  64QAM -21 dB  32QAM -18 dB  16QAM -15 dB  8PSK -13 dB  QPSK -9 dB</p>
MUX	Data multiplexer (aggregating of several parallel streams into one serial stream and back)
NAT	<p>Network Address Translation – translation of IP addresses (and ports). Network address translation (NAT) is a methodology of remapping one IP address space into another by modifying network address information in Internet Protocol (IP) datagram packet headers while they are in transit across a traffic routing device. The technique was originally used for ease of rerouting traffic in IP networks without renumbering every host. It has become a popular and essential tool in conserving global address space allocations in face of IPv4 address exhaustion.</p>
RFU	Radio Frequency Unit
PBPS	Packet Multiplexer
RFI	RF interface – interface towards PBPS
RSL	Received Signal Level in dBm
RSSI	Received Signal Strength Indication – received signal strength in mV, measured on BNC outdoor unit connector.
SDI	Serial Digital Interface
SFP	<p>A Small Form-factor Pluggable transceiver is a compact, hot-pluggable transceiver used for both telecommunication and data communications applications. The form factor and electrical interface are specified by a multi-source agreement (MSA). It interfaces a network device motherboard (for a switch, router, media converter or similar device) to a fibre optic or copper networking cable. SFP transceivers are designed to support SONET, gigabit Ethernet, Fibber Channel, and other communications standards.</p>
SNMP	Simple Network Management Protocol – protocol for remote system management
TBE	Time Between Errors
TDM	<p>Time-Division Multiplexing is a method of transmitting and receiving independent signals over a common signal path by means of synchronized switches at each end of the transmission line so that each signal appears on the line only a fraction of time in an alternating pattern.</p>
TLE	Time since Last Error occurrence
UART	<p>A Universal Asynchronous Receiver/Transmitter is a computer hardware device that translates data between parallel and serial forms. UARTs are commonly used in conjunction with communication standards such as TIA, RS-232, RS-422 or RS-485. The universal designation indicates that the data format and transmission speeds are configurable. The electric signalling levels and methods, such as differential signalling, etc., are handled by a driver circuit external to the UART.</p> <p>A UART is usually an individual (or part of an) integrated circuit used for serial communications over a computer or peripheral device serial port. UARTs are now commonly included in microcontrollers.</p>
VLAN	<p>Virtual Local Area Network – the possibility to create more logical networks on one physical medium. A virtual LAN is any broadcast domain that is partitioned and isolated in a computer network at the data link layer (OSI layer 2).</p>

Abbreviation	Description
	<p>To subdivide a network into virtual LANs, one configures a network switch or router. Simpler network devices can only partition per physical port (if at all), in which case each VLAN is connected with a dedicated network cable (and VLAN connectivity is limited by the number of hardware ports available). More sophisticated devices can mark packets through tagging, so that a single interconnect (trunk) may be used to transport data for multiple VLANs.</p> <p>Grouping hosts with a common set of requirements regardless of their physical location by VLAN can greatly simplify network design. A VLAN has the same attributes as a physical local area network but it allows for end stations to be grouped together more easily even if they are not on the same network switch. VLAN membership can be configured through software instead of physically relocating devices or connections. Most enterprise-level networks today use the concept of virtual LANs. Without VLANs, a switch considers all interfaces on the switch to be in the same broadcast domain. To physically replicate the functions of a VLAN would require a separate, parallel collection of network cables and equipment separate from the primary network. However, unlike physically separate networks, VLANs share bandwidth, so VLAN trunks require aggregated links and/or quality of service prioritization.</p>
VLAN ID	VLAN Identification
VTU	Table of rules for VLANs
W0-3	Names of memories in device (W0 is boot memory)

This page is intentionally unused.'