

Electro-Resales LLC

The Electro-Punk Console - APC

A Little Background

Early 2014 we sold a pre-built version of the well-known Forrest Mims III Atari punk console (APC) that incorporated some modifications and extras of our own devising. We discontinued this product in 2016 after making available an add-on LFO and a sequencer. Late in 2018 we decided to add more kits to our product line and to expand our audio offerings once more. To that end we are now offering this new version of the APC in kit form only. It incorporates the original 556 dual oscillator set up with an option to bring a Light Dependent Resistor (LDR) into circuit to produce a simple optical 'Theremin style' effect.

We have discarded the external control voltage circuitry, so further expansion by us is not envisaged, however, some notes are included at the end of this document on how to build onto and expand the basic design.

Design Notes or 'the why of our design'.

This version includes some features that we wish we had used in our previous design, for example the audio out connector is a full size $\frac{1}{4}$ " jack. We learned the hard way that a 3.5mm jack does not have the stamina to work long term in this design. Power for the unit is provided by a 9 volt battery that is fixed to the PCB using a battery holder. Previous designs relied on the user providing power to a screw terminal jack that again was not ideal solution. An on/off switch is included to allow the unit to be self-contained and reduces the chance of discharging the battery.

How does it work?

The APC design is simplicity itself, but the range of sound effects possible are wide and the scope for expansion of the design equally large.

The 556 timer chip is a dual 555 timer package, which means it has 2 x 555 timers built in to one package. This very versatile chip has many (many) applications and in this design the two timers are configured with one as an Astable multivibrator and the other as a Monostable multivibrator. The Astable unit is the main oscillator or noise maker, its output is used to trigger the monostable and the monostable acts as a pulse duration control or divider of the oscillator that means the resulting sounds are chopped or extended depending on the setting of the divider potentiometer, while the oscillator potentiometer defines the frequency of the Astable.

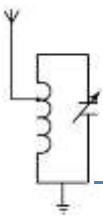

Electro-Resales LLC

Building the Kit

Our kit contains all the parts you will need to build the APC, including the PCB and hardware plus all the electronic components. Our step by step process guides you in assembling the kit. If you have already made some kits this one should take about 30 – 45 minutes, beginners may need a little longer, but it is suitable for all skill levels.

Start by reviewing the parts list against the supplied parts:

Parts List

Part Name		Quantity	Part Identification
R1	1 K Ohm Resistor	1	Brown Black Red bands OR Brown Black Black Brown Brown(5 band resistor)
R2	10 K Ohm Resistor	1	Brown Black Orange bands OR Brown Black Black Red Brown (5 band Resistor)
R3	4.7 K Ohm Resistor	1	Yellow Violet Red bands
C1	10uF Electrolytic Capacitor	1	Small black or red tubular capacitor
C2/C3	10 nF Ceramic Capacitor	2	Small yellow or brown capacitor marked 103
C4	100nF Ceramic capacitor	1	Small yellow or brown capacitor marked 104
VR1/VR2	500 K Ohm Potentiometer	2	PCB style vertical potentiometers
ICI	NE 556	1	14 Pin black plastic integrated circuit
JP1	2 Position Header + Shunt	1	2 silver or gold pins plus a red shunt
LDR	Light dependent resistor	1	Small oval disk with wires coming out bottom
JP2	¼" Jack socket	1	Large black socket with gold pins
S1	SPST Slide switch	1	Small black slide switch
Batt 1	9 Volt Battery holder	1	Black plastic tray or box
PCB	Double sided Circuit Board	1	Green PCB board – 4" x 3"

Once the parts list has been verified and parts sorted, take a look at the next photo, which shows the placement of all the parts on the PCB. Compare to the actual PCB to familiarize yourself with the layout.

Main components of the Electro-Punk Console are shown, with their position on the PCB arrowed, note that the three resistors and three capacitors have not been highlighted in this diagram. Take a moment to familiarize yourself with this diagram before starting construction.



When you see this symbol next to the text in this guide it indicates a tip to assist in making construction easier.

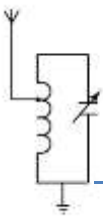

Electro-Resales LLC

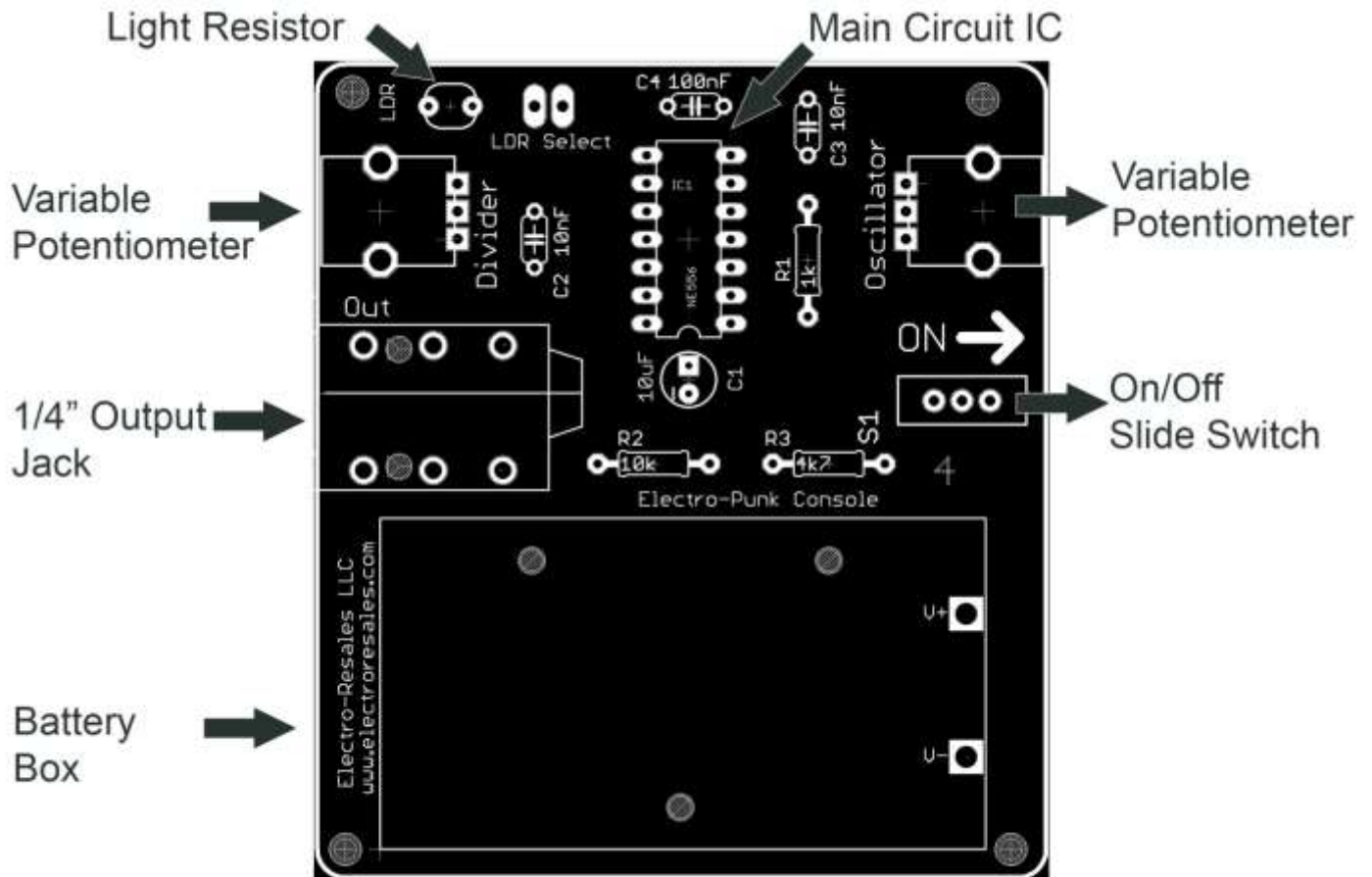

Starting Construction

The first step in building up the PCB is to install the LDR select header. This part is the two pronged part which fits in the pads marked LDR Select next to the LDR location at the top of the PCB.



To make sure the PCB looks good after you have completed it, it is good practice that the header is installed vertically at 90° to the PCB. This is best achieved by using a solderless breadboard as a support for the header during the soldering process. This helps keep the header vertical.

After installing the header locate the three resistors (R1, R2, and R3) and install them in the correct locations on the PCB, the photo shows this step completed.

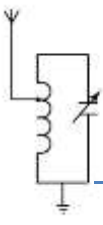

Electro-Resales LLC

Resistors located on the PCB

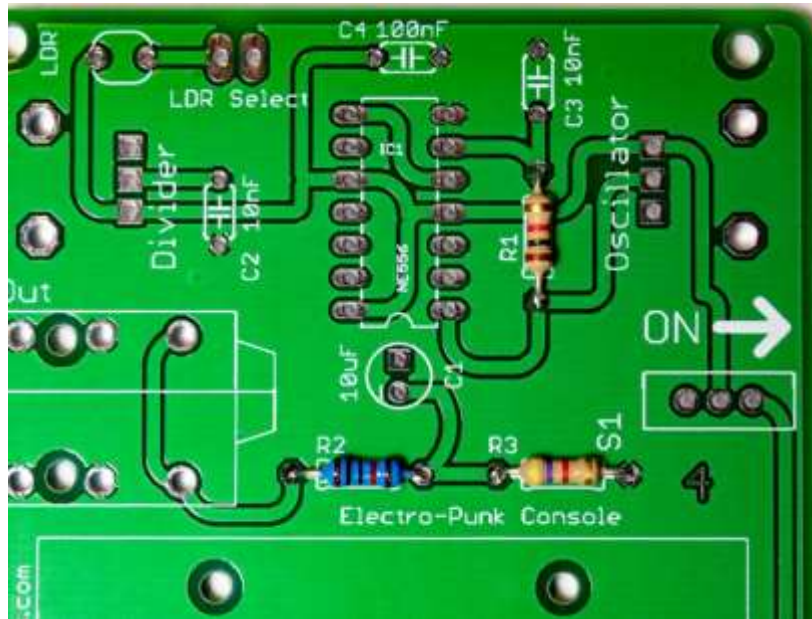

After installing the three resistors, next locate/identify the three capacitors C2, C3 and C4. We will install C1 later. Go ahead and install these three capacitors. The following picture shows this step finished.

Capacitors located on the PCB

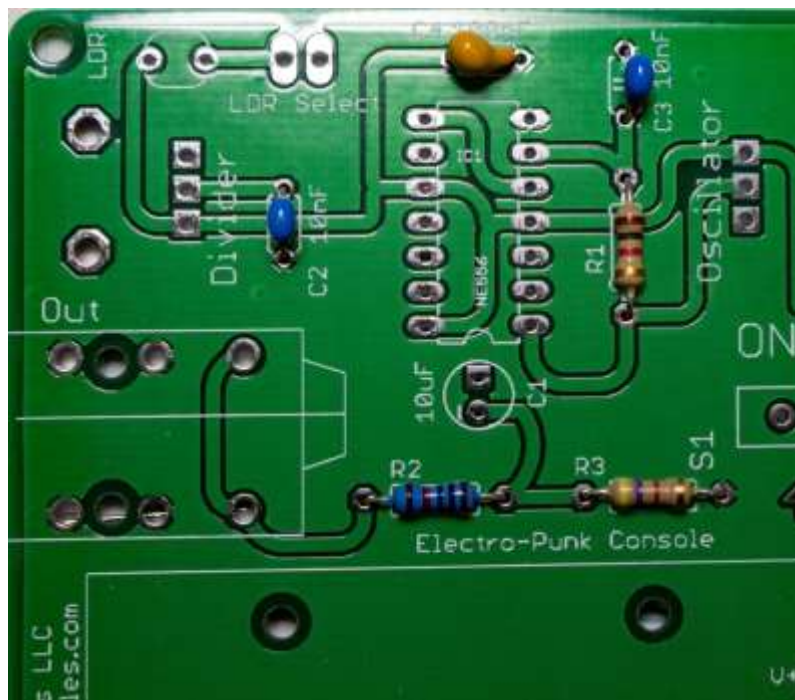

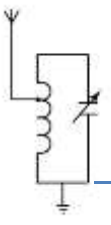

Electro-Resales LLC



Locate the 14 pin IC holder and insert the holder as shown in the picture below.

Note that the notch in the holder points towards C1. When soldering in multi-pin parts like this holder, start by tack soldering two opposite corner pins first and check the part is properly seated on the board before proceeding to solder the rest of the pins.

IC Socket installed - note location of notch on holder (Arrowed)

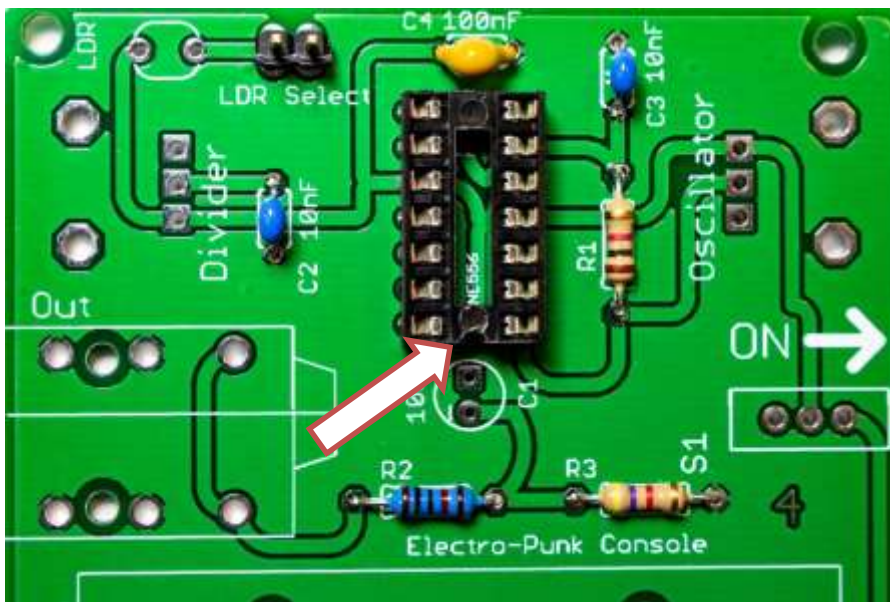

It is now time to add C1, the 10uF electrolytic capacitor; in the next photo it is ringed/arrowed.



Electrolytic capacitors are polarized and must be inserted correctly. Note the “-“symbol on the PCB legend for C1 and orient the capacitor so that the negative lead goes in this hole

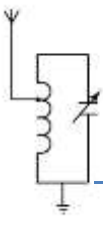

Electro-Resales LLC

Image for C1 location

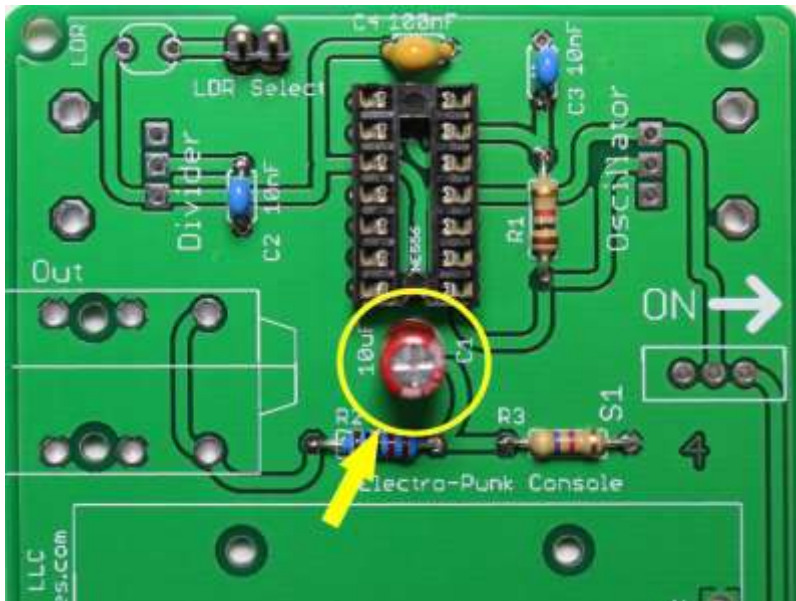

The next part to install is the on/off switch, this three leaved switch is soldered in to the position marked S1. Its orientation is not critical.

Image for switch install

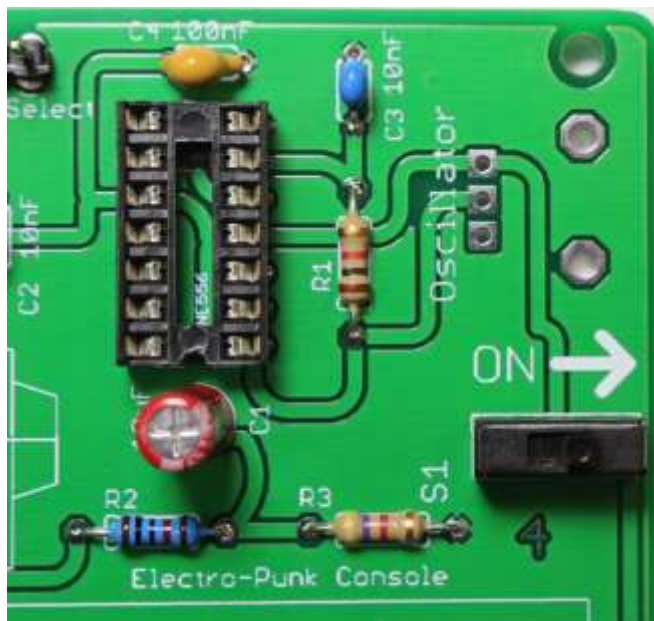

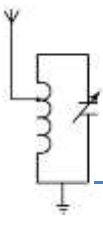

Electro-Resales LLC

Now the Light Dependent Resistor (LDR) is installed in the position marked LDR. The orientation of this part is not critical.

The image below show the part located close to the PCB, it is possible to orient this part so that it is angled at 90° to the PCB if desired.

Image for LDR insertion

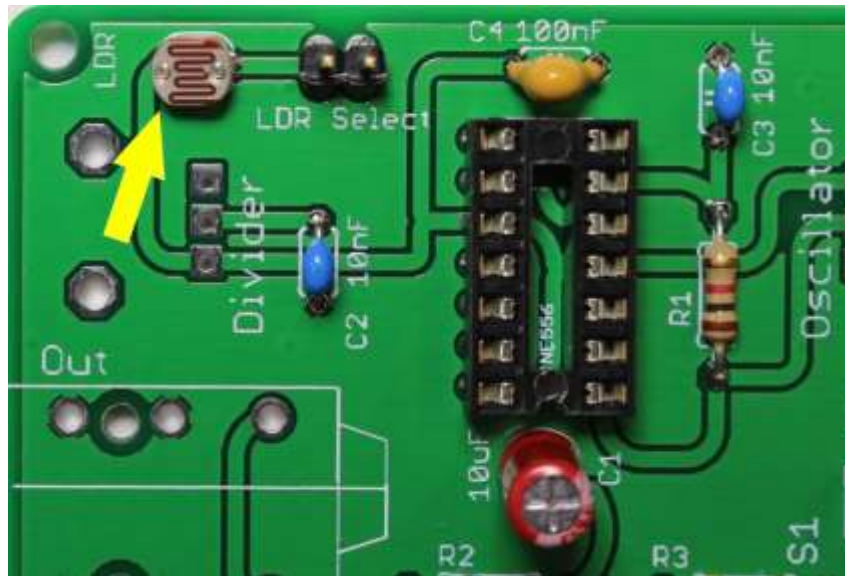

It's now time to install the ¼" output jack. This part only fits one way. Tack solder one lead and check after this tack soldering that the jack is flat on the PCB, then solder all remaining pins.

Jack Socket installed

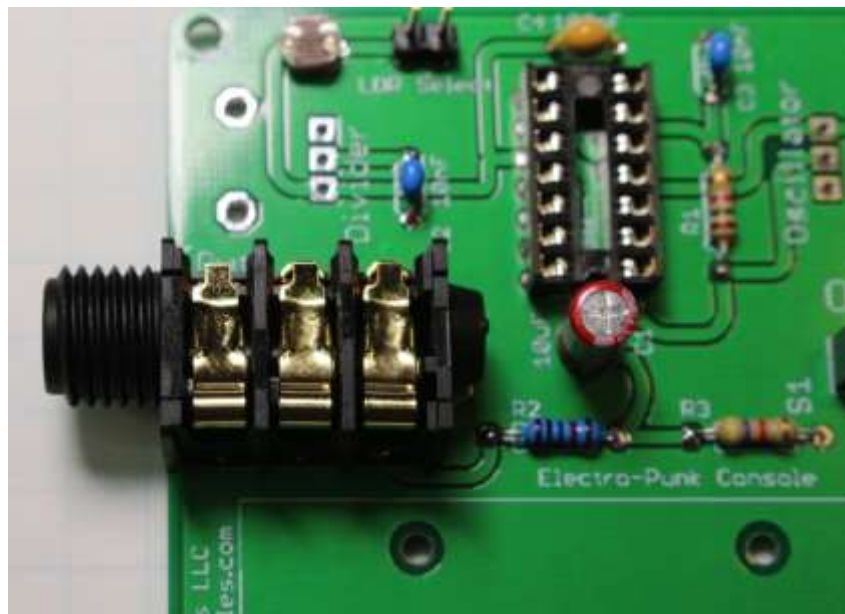

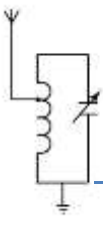

Electro-Resales LLC

Now install the two potentiometers marked Divider and Oscillator. These are both the same value so are interchangeable.



These parts will snap into the board, however, to make this easier, first gently squeeze the mounting lugs in a little using finger pressure. Then align the three connector pins with their mounting holes and then push the mounting lugs into their holes. Use gentle pressure to ensure correct fit. Before soldering make sure the parts are square to the PCB.

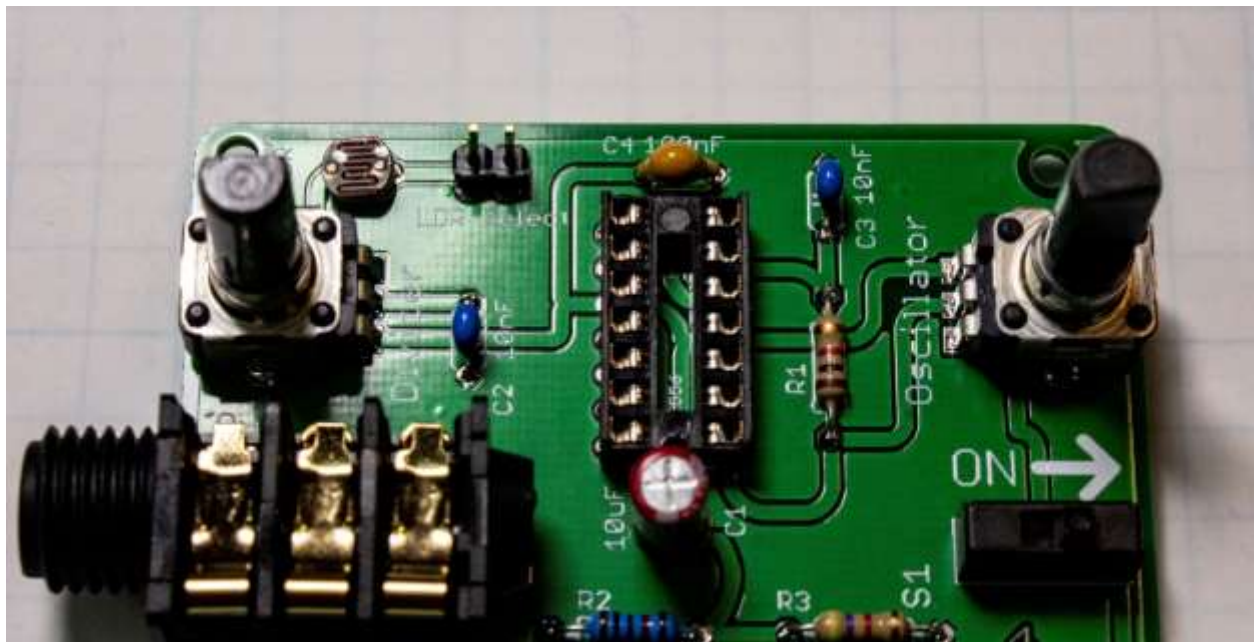

To complete construction add the battery box and solder the pins in place. To help keep the box in place hot glue or gel superglue can be used to assist in keeping the battery box from moving – Please see the note on page 10 about using alternate power sources if the battery box is not going to be used.

Finally insert the NE566 chip. This is the heart of the APC, has 14 Pins and needs to be mounted in the socket with the notch on the chip matching the notch on the socket. The chip pins will need to be compressed very slightly to ensure they fit in the socket. Do this one side at a time by pressing the chip on the bench so that all pins move at the same time.

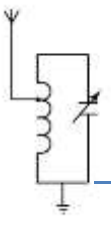

Electro-Resales LLC

Aligning the chip pins

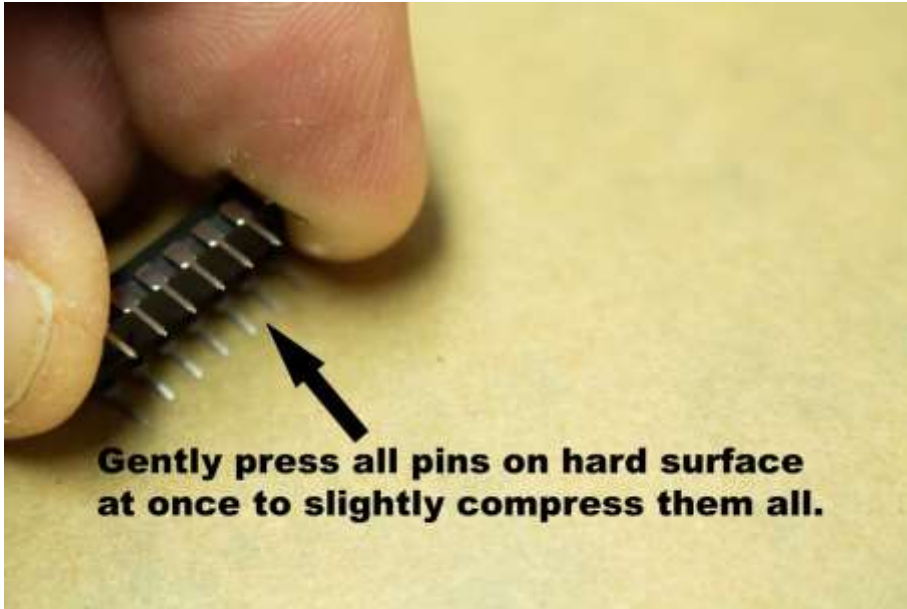

Insert the chip with notch aligned to the notch on socket

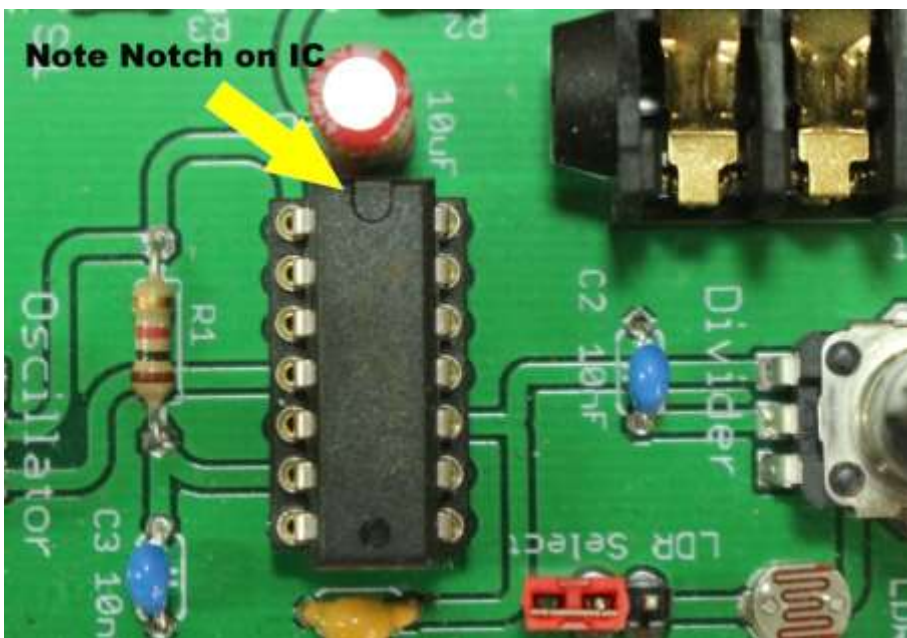

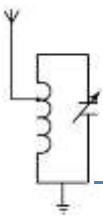

Electro-Resales LLC

Completion and initial tests.

The board is now complete and ready for use. Before inserting a battery though, carefully check the following points to ensure success.

1. Make sure all the resistors and capacitors are in the correct place.
2. Ensure the chip is in the socket the correct way round and all pins are inserted in their sockets.
3. Carefully check the solder side for solder splashes, shorts of solder or poorly soldered joints, use a magnifier, or have a second pair of eyes take a look. Remove shorts and rewet any joints that look poor.

When you are happy to continue, make sure the switch (S1) is in the off position , insert a new 9 volt battery into the holder, this may need the battery to be angled in slightly towards the snaps, before locking in to place.

Move both controls to their center position and initially do not have the header shunted.

Attach a cable with jack plugs to an amplifier, switch on the amp, and then the APC. You should hear something at this point, if not, move one or both controls to make sure the APC is working.

After testing the basic controls it's now time to test the LDR operation. Attach the header shorting block so it covers or shorts both of the pin header contacts. By blocking the amount of light getting to the LDR, maybe by moving your hand over the LDR, or shining light on to the LDR the pitch/tone and range of control over sounds produced increases.

If the board passes these tests it is ready for use. Experiment with how the controls affect the sound produced and also their interactions. Remember that the best or widest range of sounds is achieved by small or careful movement of the potentiometers.

A note about using alternate power sources

If you intend to use a power source other than the supplied battery box, please note that the battery terminal legend on the PCB is reversed. This means that the '+' mark is for the '-' or ground wire and the '-' is for the positive connection. If you intend to use the supplied battery box just install it as instructed in this guide and all will be good.

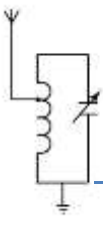

Electro-Resales LLC

Expansion possibilities

As mentioned at the start, while we don't intend to offer any options for the APC it is an open platform that is easily expanded. Some possibilities for expansion are outlined below.

1. Remove or do not install the LDR. The LDR position allows other inputs to be tested.
2. Another variable potentiometer can be connected to the LDR pads and used to change the overall sound produced. Try a 100K Ω value to start.
3. An additional oscillator can be input at the LDR position, a sine wave oscillator with a 3v peak can be added to increase the range of sounds considerably
4. A simple keyboard can be made up of resistors that can be switched in to the circuit. Connect the resistors in series and ground the connection between two resistors using a push switch will allow weird sounds to be achieved in a repeatable form.
5. The LDR position would also be suitable for introducing a sequencer output where a series of resistances are clocked to produce repeatable note sequences.

These are just a few ideas, we are sure you can come up with other, better, options. Experiment and good luck.

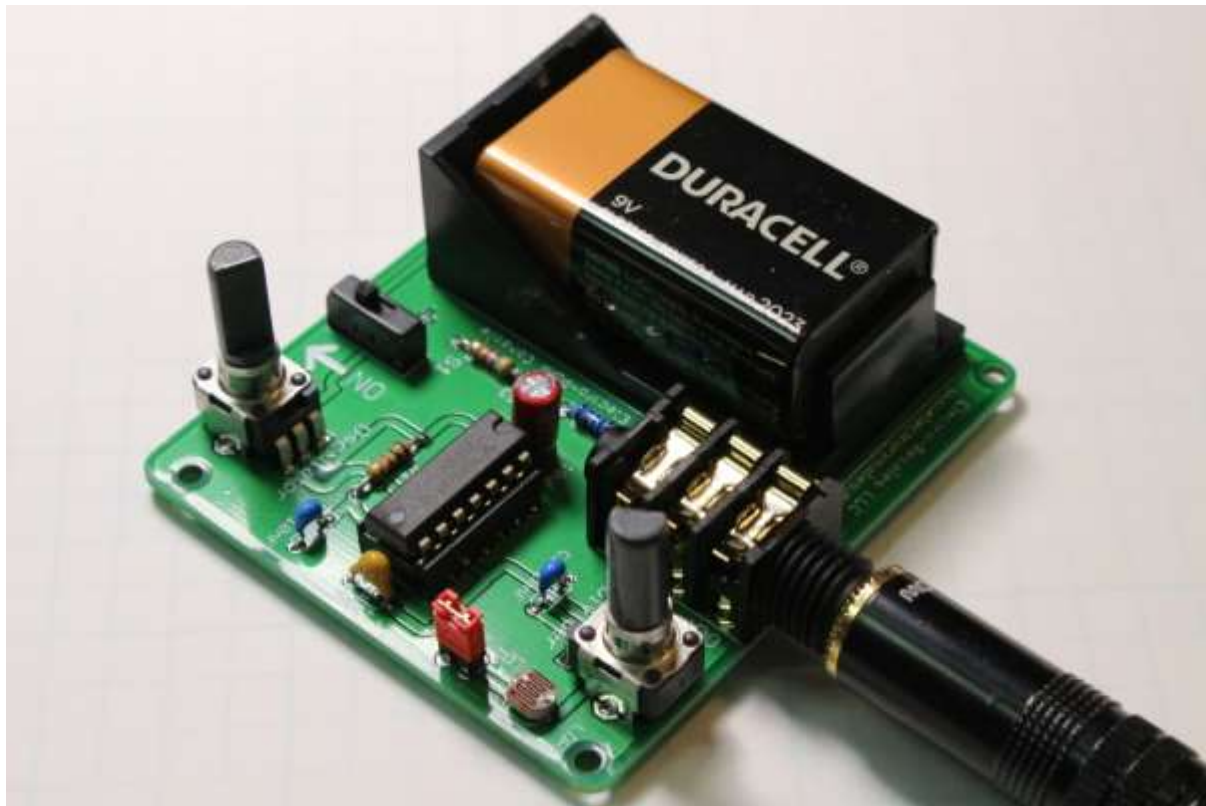

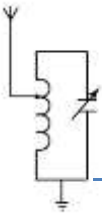

Electro-Resales LLC

The small Print

DISCLAIMER

Any person who constructs or works on electronic equipment may be exposed to hazards, including physical injury, the risk of electric shock or electrocution.. These hazards can result in health problems, injury, or death. Only qualified persons who understand and are willing to bear these risks themselves should attempt the construction of electronic equipment. By purchasing this item, the buyer acknowledges these risks.

There is a risk of electric shock, electrocution, burns, or fires that is inherent in the construction and use of electronic equipment. By purchasing this item, the buyer acknowledges these risks.

IN NO EVENT SHALL THE SELLER BE LIABLE FOR ANY SPECIAL, INCIDENTAL OR CONSEQUENTIAL DAMAGES OF ANY NATURE including, but not limited to, property damage, personal injury, death or legal expenses. Buyer's recovery from Seller for any claim shall not exceed the purchase price paid by Buyer for the goods, irrespective of the nature of the claim, whether in warrant, contract or otherwise.

By purchasing this item, BUYER AGREES TO INDEMNIFY, DEFEND AND HOLD SELLER HARMLESS FROM ANY CLAIMS BROUGHT BY ANY PARTY REGARDING ITEMS SUPPLIED BY SELLER AND INCORPORATED INTO THE BUYER'S PRODUCT.