

since 1939  
January 2, 2024

# ENGINEERING & CUSTOM WORK BROCHURE

## KPMI<sup>®</sup> ENGINEERING & MANUFACTURING VALVETRAIN FOR 80-YEARS & 2-GENERATIONS



KPMI<sup>®</sup>  
Designs and manufactures  
longevity into valvetrain

Our Primary Focus Is:  
Engineering product  
that exceeds expectations

At KPMI<sup>®</sup>  
There are no exceptions  
for quality

World  
Top Fuel Champion  
*Larry "Spiderman" McBride*

European  
SuperTwin Champion  
*Ton Pels*

European  
Top Fuel Champion  
*Ian King*

Valvetrain That The Top Champions of the World Rely On

# WWW.KPMI.US





# KPMI® ENGINEERING & MANUFACTURING VALVETRAIN FOR 80-YEARS & 2-GENERATIONS

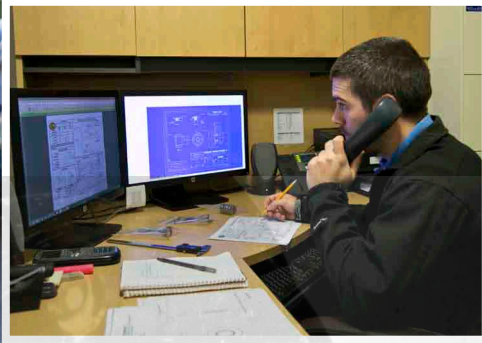

**KPMI®**  
Designs and manufactures longevity into valvetrain

**Our Primary**  
Engineering product that

## Company

Kibblewhite Precision Machining, Inc. (KPMI®) is a 80 year old valvetrain manufacturing company supplying the Motorsport Industry and select OEM's. We stock and distribute over 3,000 items to customers around the world. No other company in the world has our product coverage for the motorsport industry. You will not find any other company with such an extensive product line solely dedicated to the motorsport industry.

KPMI® not only manufactures ready-made parts, we also provide contract manufacturing for OEM and other parties. Our expert services include engineering, prototyping, and limited or full production runs.

## Legacy

Kibblewhite Precision Machining, Inc. was founded by James L. Kibblewhite in 1939. In 1989 the operation was taken over by William F. Kibblewhite, Jim's son. William Kibblewhite took the solid foundation created by his father and dramatically expanded the product line to provide the vast coverage that it offers today.

KPMI is known by its trademark and registered marks: Black Diamond™, White Diamond®, Tensilite®, Kibblewhite® and KPMI®. Know that when you purchase products under these brands you are purchasing product that has been engineered by a company that's been doing so for 80 years and 2 generations. This wealth of knowledge can be seen in the product detail, fitment, material choices, processes and the uniqueness in which all systems and components are expected to achieve the mechanical work they will be asked to do.

## Employees

Kibblewhite valvetrain and custom engineered components are second to none. KPMI® employs twenty six employees and fosters a work smart culture. The dedication of top notch employees (A-players) in Engineering and Customer Service is the reason why we are the industry leader in valvetrain development. Putting our customers first can be found in every element of product development and you will see that precision level of detail in every single package that is shipped out of our warehouses. This type of commitment is found in the class of employee, equipment, and investment in emerging technologies.



# MADE IN USA

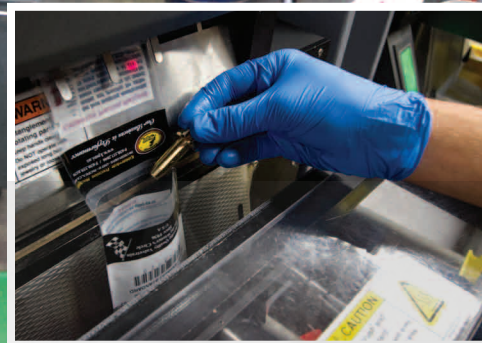

**Focus is :  
exceeds expectations**

**At KPMI®  
There are no exceptions for quality**

## Facility

Kibblewhite encompasses five locations and over 20,000 square feet of Machine Shop, Office, Engineering, and Warehouse space. KPMI® has spent the past five years aggressively updating our operations. Our complete facility has eleven of the latest model CNC lathes (2010 & later), CAD, CAM, and custom machining equipment. Our Engineering Department and machinists are ready and waiting to assist you with your custom requirements and drive our ongoing production of high performance valvetrain systems for 4-stroke engines.

## Quality Control

It is our sole intent to provide our customers with product that works right the first time and gives maximum value for the dollar in terms of reliability and performance. None of our product achieves final approval without first traveling through a grueling development flow process. Final reviews require three engineering signatures and a signature from production. What this means is that there are three independent reviews following each and every product through all phases of development before the final review and production signature can be granted. I am very proud of what we do and of every single employee that has been hand selected to contribute to the success of KPMI®.

We measure our success by our satisfied customers and for this we are truly grateful. Without our loyal customers and their continued demand for consistent, high quality valvetrain and engineering services, we would not be the company that we are today. Because of this we thank each and every one of our customers and future customers.

Sincerely  
William Kibblewhite



**FX: 650-359-8574**



**WWW.KPMI.US**



# VALVE DEVELOPMENT



## Experimental Engine Technology Valves

KPMI® has created this “Engineering Custom Work” brochure to give our customers a snapshot of our custom work capabilities here at KPMI®. Many know us for our extensive line of finished goods (valvetrain components) for the motorsport industry. However, many of our customers are unaware we have the capability to custom design and manufacture one-off prototypes or offer in-house full run production for a variety of motorsport and non-motorsport applications.

KPMI® has a full dedicated engineering department solely responsible for the development, fitment and review of custom designs. These designs can either be directly per the customer’s specifications or from specifications derived from KPMI® Engineering development team. KPMI® utilizes the latest in scientific and engineering software, including CAD/CAM technologies, Finite Element Analysis software, flow bench testing, rapid prototyping and computerized valvetrain dynamics simulation software.

However, we at KPMI® are not limited to valvetrain and have designed and manufactured elevator parts, generator parts, drone parts, window parts, airplane prototype parts, and pre-production to full production runs for accelerated testing.

We also offer private labeling for a nominal fee. KPMI® has invested thousands of dollars in state of the art label printer(s) and laser etching equipment just for the purpose of in-house private labeling. Some of our customers have KPMI® develop, manufacture, inspect, and package, so product can be delivered complete, finished and ready for sale.

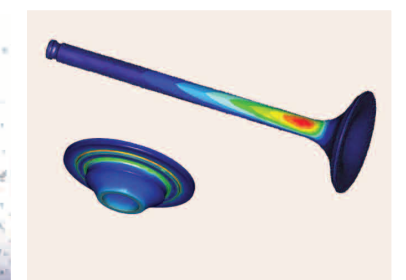
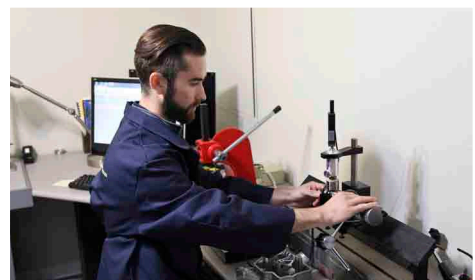

# VALVE DEVELOPMENT



## 1958 Ferrari 412 MI Valves

The KPMI® Custom Work Department has produced replacement valves for the prestigious Ferrari 412 MI. By obtaining valve samples and the mating tappet adjusters, KPMI's Engineering Team was able to create an improved set of stainless steel replacement valves. This all through the use of our leading edge measurement techniques and SolidWorks® modeling software. The photo above displays the final work of our engineers: forged and machined stainless steel valves with special thread and groove features to mate with the original tappet adjusters.

*KPMI® is eager to earn your next custom work project and invites you to contact our engineering department for whatever your needs may be.*

**Mike Perry, Dir. R&D**

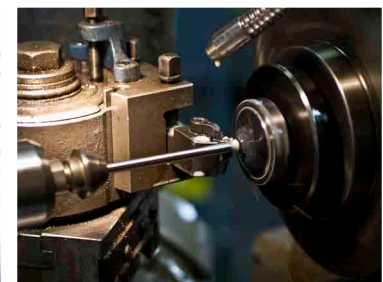

**FX: 650-359-8574**



**WWW.KPMI.US**



# GUIDE DEVELOPMENT



## 1964 Ferrari BRM Valve Guide

One of our customers sent us a used 1964 Ferrari BRM valve guide. The KPMI® Custom Work Department provided the sample guide to the KPMI® Engineering department for reverse engineering. Engineering sourced the O-ring and completed the RE... (Reverse Engineering) of the sample. By using one of two Mitutoyo PH-A14 Optical Comparators, suited with fiber-Optic edge sensing, KPMI's Mechanical Engineers were able to very accurately pull dimensions from the sample. Using the information gathered from the RE, a PRO/E drawing was created for the customer's review. The photo above is the finished product machined from solid C630 / NiAlBrnz.

***KPMI® is eager to earn your next custom work project and invites you to contact our engineering department for whatever your needs may be.***



**Jacob Harrington, Engineer**

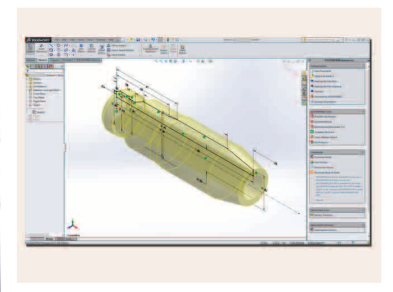

# RETAINER DEVELOPMENT

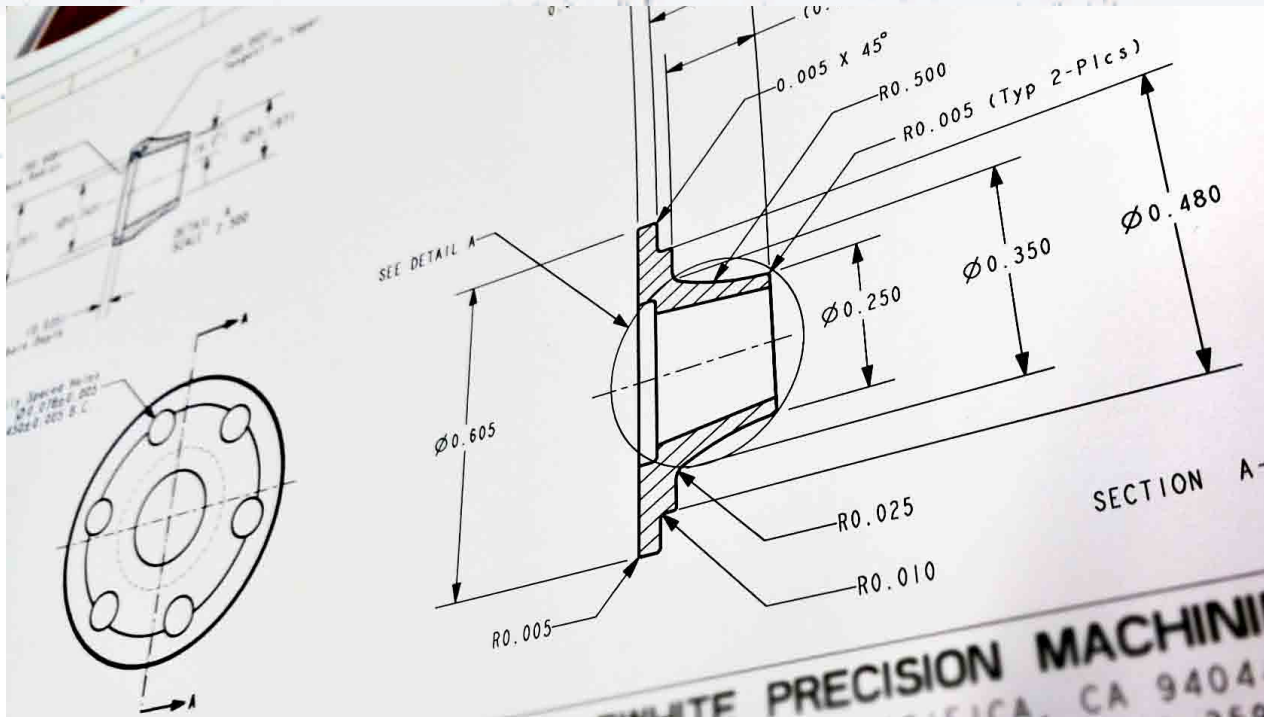

Utilizing the advances in power, speed, and user interface of modern software, KPMI® employs an arsenal of software programs to plan, design, simulate, fabricate and test all aspects of development and production.

- **3D Modeling/FEA:** Every KPMI® component is designed using the latest in 3D modeling technologies, allowing KPMI® engineers to assemble entire valvetrain systems virtually to verify fitment and clearances. Once assembled, each system is subject to a rigorous Finite Element Analysis (FEA) that allows KPMI® engineers to validate designs and isolate areas of stress concentration. This FEA analysis ensures that KPMI® parts are both light and strong enough to stand up to the rigorous environment inside a modern racing engine.
- **Valvetrain Simulation:** Once a KPMI design has been modeled and refined the entire system is simulated using valvetrain simulation software. This allows KPMI® engineers to “tune” each system to ensure that it will work harmoniously in the engine.
- **Spring Design:** Each of KPMI’s valve springs are designed using advanced spring design software that allow KPMI® engineers to balance designs for the perfect blend of performance and longevity.

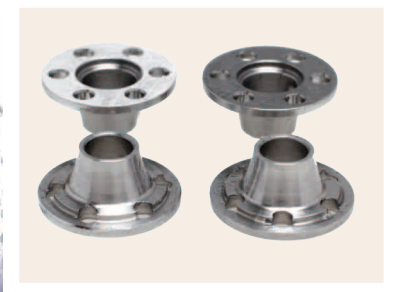



# RETAINER DEVELOPMENT

## SPRING KITS **LARGEST SELECTION** IN THE WORLD



- Race & Direct O. E. M. Replacement
- Super Clean CrSi Wire
- Complete F. E. A. Design
- 100% Quality Controlled
- Manufactured in the USA

All KPMI® valve springs are designed in house using sophisticated, proprietary design and simulation software programs. Our engineers, software, and 80 years of experience enable us to determine critical characteristics including stress, natural frequency, system harmonics, required spring force, and fatigue life. Our spring manufacturing partners are U.S based companies that are ISO certified. The Super-Clean Chrome-Silicon valve spring wire we use is traceable back to Kobe Japan where some of the best spring wire in the world is manufactured.

Each spring goes through a rigidly controlled heat treatment, stress relief, and shot peening process. Combining our design, simulation, and manufacturing protocols with this premium quality valve spring wire allows KPMI® to supply you with the best possible valve springs period!

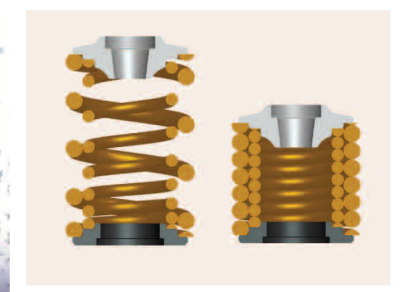
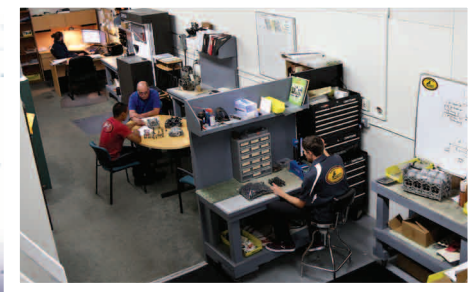
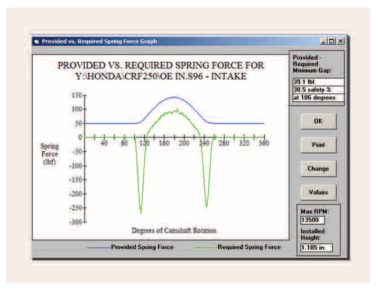
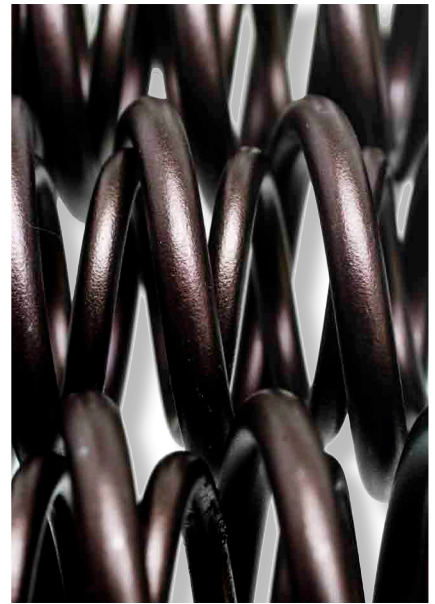



# KPMI® CUSTOM VALVE ORDER FORM



## KPMI Custom Valve Order Form

<b>Part Number</b>	
<b>Engr. Approval / Date</b>	

<b>Additional Specifications</b>	
Rocker Arm	YES <input type="checkbox"/>
Rocker Arm (w/ Elephant Foot)	YES <input type="checkbox"/>
Cam Follower (Shim & Bucket)	YES <input type="checkbox"/>
Using Lash Cap	YES <input type="checkbox"/>
Intake Valve	YES <input type="checkbox"/>
Exhaust Valve	YES <input type="checkbox"/>

<b>Customer Information</b>	
Contact:	
Company:	
Phone:	Fax:
E-Mail:	Date:
Make:	Disp:
Model:	Years:
Material:	<input type="checkbox"/> S.S. <input type="checkbox"/> Ti. <input type="checkbox"/> Other:
Blank Part #:	
Notes:	

	Groove Dimensions		
	Radius Groove	Square Groove	Triple Groove
Groove Location:			
Groove Minor Ø:			
Groove Width:			
Groove Radius:	N/A		
Groove Spacing:	N/A		

Groove Location is measured from the tip of the valve to the center of the radius or to the top of the square groove (for the triple groove it is measured from the tip of the valve to the center of the middle radius)

Reduced Dia. Groove Detail (if applicable)	
-A- Undercut Ø:	
-B- Undercut Length:	
-C- Groove Location:	
-D- Groove Ø:	
-E- Groove Width: $E = \sqrt{E^2 + (A-D)^2 + (A-D)^2}$	
-F- Groove Radius:	

Dish Dimensions	
<b>Radius Dish</b>	
-A- Dish Radius:	
-B- Dish Depth:	
-C- Dish Width:	
<b>Angle Dish</b>	
-D- Dish Depth:	
-E- Dish Width:	
-F- Dish Angle:	

KIBBLEWHITE PRECISION MACHINING, INC. 580H Crespi Dr. Pacifica, CA 94044 PH: 650-557-2046 FX: 650-359-8574

[www.kpmi.us](http://www.kpmi.us)





# KPMI<sup>®</sup> CUSTOM GUIDE ORDER FORM

## KPMI Custom Guide Order Form

Part Number	
Engr. Approval / Date	
Customer Information	
Company:	
Contact:	
Phone:	
Fax:	Date:
E-mail:	
Material:	<input type="checkbox"/> Cast Iron <input type="checkbox"/> Ni Al Bronze <input type="checkbox"/> Manganese <input type="checkbox"/>
Notes:	

Shouldered Guide	Snap Ring Guide	Stepped Shoulder Guide

Make:	Model:	Disp:	Years:
-------	--------	-------	--------

KIBBLEWHITE<sup>™</sup> PRECISION MACHINING, INC. 580H Crespi Dr. Pacifica, CA 94044 PH: 650-557-2046 FX: 650-359-8574

[www.kpmi.us](http://www.kpmi.us)



# KPMI® CUSTOM PUSHROD ORDER FORM



<h2 style="color: yellow;">Custom Pushrod Order Form</h2>	Part Number: <input style="width: 90%;" type="text"/>
	Date: <input style="width: 90%;" type="text"/>

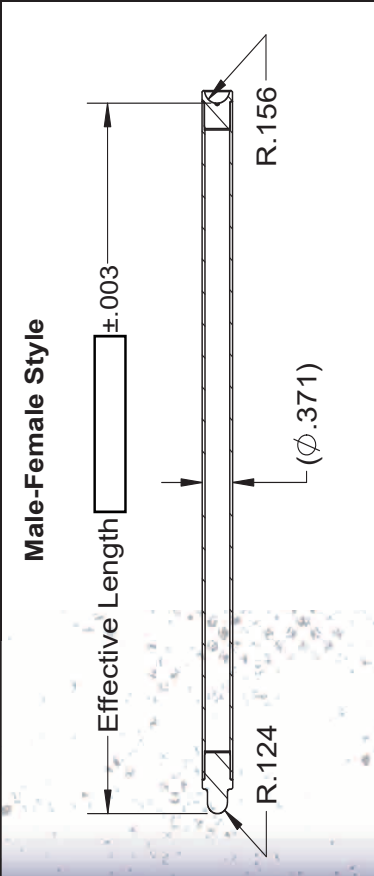
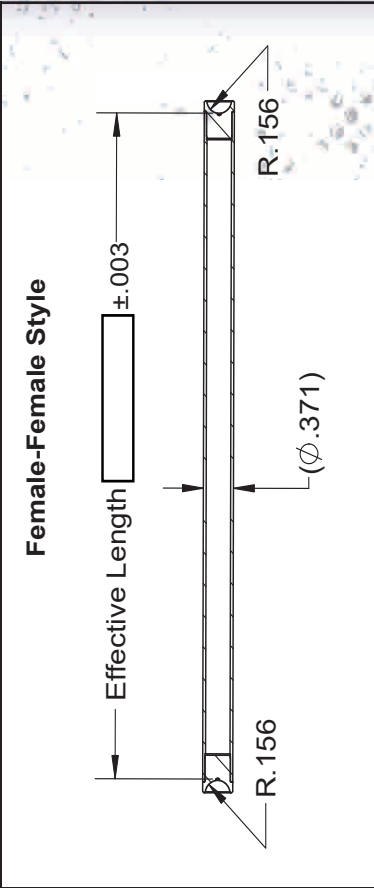

KPMI P/N	Kit Includes	Model	Material	Retail Pricing
90512-2	2 Female Ended Pushrods / 2 Loose Female Endpieces			
90502-4	4 Female Ended Pushrods / 4 Loose Male Endpieces	Various	•Thin Wall Chrome Moly Tube •H.T. Steel Tips	\$126.13
90512-4	4 Female Ended Pushrods / 4 Loose Female Endpieces			

<b>Machining Information:</b>	<p>                 A: <math>\phi .371</math> OD                  B: 9.120 Overall Length                  C: <math>\phi .305</math> ID Before Machining                  D: R.124    E: 0.675                  F: 0.375    G: 0.310                  Break D edge only at .015" x 45°             </p>
-------------------------------	---

Pushrod Information	
KPMI Blank P/N:	Male-Female 90502-2 QTY: <input style="width: 50px;" type="text"/> 90502-4 QTY: <input style="width: 50px;" type="text"/>
KPMI Blank P/N:	Female-Female 90512-2 QTY: <input style="width: 50px;" type="text"/> 90512-4 QTY: <input style="width: 50px;" type="text"/>
Custom Work Pricing:	KPMI® will custom machine and finish 2 or 4 pushrods for a flat fee of \$120.00.
Notes:	Please visit <a href="http://www.kpmi.us">www.kpmi.us</a> for our complete lineup of pushrods and more.

Customer Information			
Contact Name:	<input style="width: 95%;" type="text"/>		
Company Name:	<input style="width: 95%;" type="text"/>		
Phone:	<input style="width: 20px;" type="text"/>	<input style="width: 20px;" type="text"/>	<input style="width: 20px;" type="text"/>
E-mail:	<input style="width: 95%;" type="text"/>		
Make:	Model: <input style="width: 50px;" type="text"/>	Disp: <input style="width: 50px;" type="text"/>	Years: <input style="width: 50px;" type="text"/>

Customer Approval: <input style="width: 95%;" type="text"/>	Date: <input style="width: 95%;" type="text"/>
---	--

KIBBLEWHITE PRECISION MACHINING, INC. 580H Crespi Dr. Pacifica, CA 94044 PH: 650-557-2046

[www.kpmi.us](http://www.kpmi.us)





# KPMI<sup>®</sup> CUSTOM SEAT ORDER FORM

## KPMI Custom Seat Order Form



Part Number:

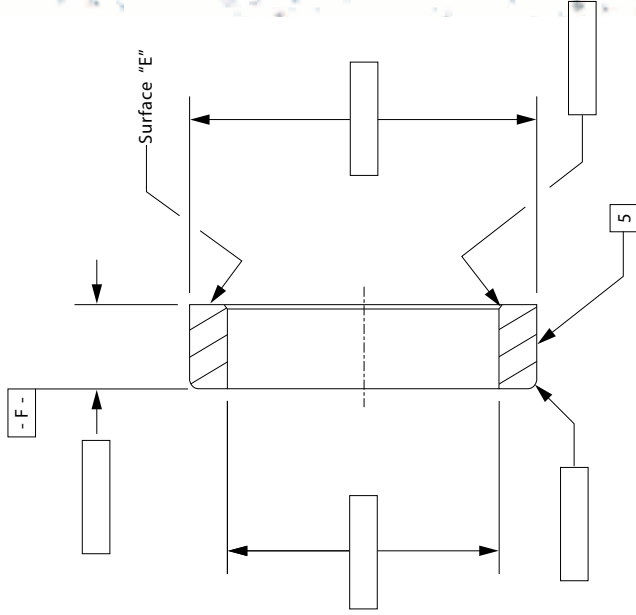
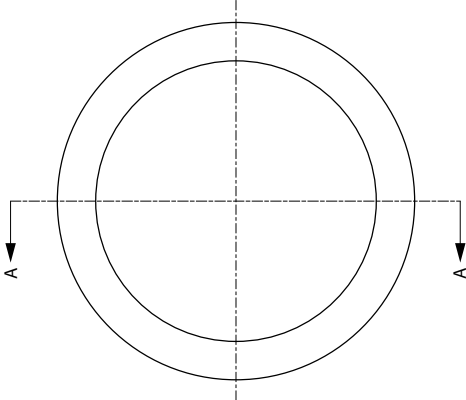

Contact Name:			
Company Name:			
Phone:		Date:	
Make:		Model:	
Disp:		Years:	
Customer Approval:		Date:	

Additional Notes:			
KPMI Blank P/N:			
Material:		<input type="checkbox"/> SAE 630	<input type="checkbox"/> G2 Cast Iron
Total Cost Per Seat:			Qty.
(KPMI use only)			
Total Cost:			
(KPMI use only)			

NOTES:

1. Break and deburr all sharp edges 0.010" X 45°
2. Finish O.D. to RMS-16 parallel and round within 0.0004"  
(For wall thickness less than 0.120", parallel and round within 0.0008")
3. Surface "E" parallel to Datum F within 0.002"
4. I.D. and O.D. must be concentric within 0.010" TIR
5. I.D. and O.D. must be parallel within 0.002"
6. O.D. must be perpendicular to Datum F within 0.002"
7. (U.O.S.) Unless Otherwise Specified

KIBBLEWHITE<sup>™</sup> PRECISION MACHINING, INC. 580H Crespi Dr. Pacifica, CA 94044 PH: 650-557-2046 FX: 650-359-8574

[www.kpmi.us](http://www.kpmi.us)



# KPMI® LEGAL NOTES



Since 1939, Kibblewhite® Precision Machining, Inc. (KPMI®), an independent company, has been committed to serving the valvetrain component needs of the powersport industry.

## IMPORTANT TRADEMARK NOTICES

Harley, Harley-Davidson, Knucklehead, V-Twin, Panhead, Big Twin, Evolution, Shovelhead and Sportster are registered trademarks of Harley-Davidson, Inc., Milwaukee, Wisconsin, U.S.A. Any model designations for Harley-Davidson motorcycles used in this catalog is for reference only. No parts appearing in this catalog are licensed, manufactured, sponsored or endorsed by Harley-Davidson, Inc. Use of the word Harley-Davidson, various model names and designations, and O.E.M. part numbers are provided solely for reference and fitment information, and there is no affiliation between Harley-Davidson Inc. and Kibblewhite® Precision Machining, Inc. Black Diamond™, Tensilite® and White Diamond® are registered trademarks of Kibblewhite® Precision Machining, Inc., Pacifica, California, U.S.A. All other brand names or trademarks or registered trademarks used in this catalog are the property of their respective holders.

## TERMS AND POLICIES

**PAYMENTS** - All Dealer/ Distributor orders will be shipped C.O.D., certified check / money order or prepaid by Visa®, MasterCard®, American Express® or bank wire transfer. Company checks will be accepted from Dealers or Distributors after completing a KPMI® Survey/ Application and histories warrant. All international orders should be prepaid in U.S. funds to avoid delays. Proforma invoices are available upon request. Terms are granted by arrangement only.

**DISCOUNTS** - Bank cleared advanced co-check, money order, certified check = \$15.00 discount. Proforma invoices are available upon request.

**HANDLING FEES** - Handling fees apply to all shipments and / or credit card transactions. Additionally: Drop-ship \$15.00 / Wire transfer \$20.00 / Parcel post \$15.00.

**DEALERS** - Becoming a KPMI® Dealer requires completing a Dealer Application / Survey. After a successful survey review a Dealer must initiate and maintain KPMI® Dealer status based on the following policies: 400 USD Initial Order (Pre-Paid only), 100 USD minimum orders thereafter, purchase a minimum of 1,200 USD of product per calendar year.

**DISTRIBUTORS** - Becoming a KPMI® distributor requires contacting KPMI® directly, and requesting a Distributor Application / Survey. Please allow a reasonable amount of time for processing.

**WARRANTY** - All merchandise and services offered by KPMI® are for racing use only. KPMI® warrants to the original purchaser the racing components listed in this catalog as manufactured by us to be free from defects in material and workmanship under normal use and service.

Our obligation under this warranty shall be limited to the repair or exchange of any part(s) which may thus prove defective under normal use and service within 30 days from date of installation by the original purchaser, and which our examination shall

disclose to our satisfaction to be thus defective. This Warranty is expressly in lieu of all other warranties expressed or implied including the warranties of merchantability and fitness for use and all other obligations or liabilities on our part, and we neither assume, nor authorize any person to assume for us, any other liability in connection with the sale of these components. This warranty shall not apply to components or any part thereof which has been subjected to an accident, negligence, alteration, abuse or misuse. We make no warranty whatsoever with regard to accessories or parts not supplied by us. The term "original purchaser," as used in this warranty, shall be deemed to mean that person to whom the components were originally delivered. This warranty shall apply only within the continental United States. Seller makes no warranties which extend beyond that set forth in the preceding paragraph. Subject to applicable State laws.

**SHIPPING** - We ship by Federal Express (FedEx), United Parcel Service (UPS), USPS (upon request) and DHL Express. Shipping charges are added to invoice total.

**BACK ORDERS** - We do not cancel back orders unless requested to do so.

**RETURNS** - We will not accept any returned merchandise without prior consent. All items will be inspected upon receipt. Returns due to shipping error or manufacturing defects will be replaced immediately. No returns after 30 days from invoice date. Parts returned for any other reason will be subject to a 20% or \$15.00 minimum restocking charge. Absolutely no returns on custom manufactured parts.

**MACHINE WORK** - Anything sent to Kibblewhite® Precision Machining to be machined must be accompanied with complete instructions and return address. Please be sure to include a packing list of the parts being sent to us. Any discrepancy that is not accounted for with the package(s) received will be the responsibility of the sender. Any damage to merchandise at the time of receipt will need to be handled by the sender with the carrier.

**CLAIMS** - If damage occurs to any item during transit; it is the responsibility of the freight carrier. Responsibility for the goods is passed from the shipper to carrier when the carrier leaves the point of pick-up. All claims must be made with the carrier. We will, however, help you with the claim in any way we can.

**PHONE CALLS** - We cannot accept collect calls. Our Order and Tech Line phone number is (650) 557-2046. After hours & weekends, please leave a message. Our FAX line operates 24-hours a day; the number is (650) 359-8574.

**HOURS** - Monday through Friday 8:30 a.m. – 5 p.m. (Pacific Time). After hours or weekends, please leave a message or send a FAX.

**COPYRIGHTS** - The entire contents of this catalog are copyrighted by KPMI®. All rights are reserved. Trademarks and logos represented in this catalog are the sole property of their owners. Call your dealer or account representative for verification of the latest model year applications.

© Copyright 2024 Kibblewhite Precision Machining, Inc. All rights reserved.

Copies distributed for personal internal use only. Any other use, reproduction, modification, public display, distribution or transmission of this catalog or its contents without the prior written consent of Kibblewhite Precision Machining, Inc. is strictly prohibited.

## WARRANTY & LIABILITY LIMITATIONS

Except as may be expressly set forth in the product invoice, KPMI® makes no representations or warranties as to any of its products, express or implied, including, without limitation, any warranties of merchantability or fitness for a particular purpose, under Section 2314 or 2315 of the California Uniform Commercial Code or otherwise. Motorcycles can be dangerous. KPMI® has no control over the usage of any part. KPMI® expects the Dealer and the Dealer's customers to exercise good judgment as to the proper selection, installation, use, and maintenance of any parts. KPMI® assumes no responsibility for damage or injury of any kind because of the misuse or the improper application or installation of any parts in any way by the Dealer, the Dealer's customers or any other person. KPMI® shall not be liable for any indirect or consequential damages whatsoever. All matters shall be interpreted under California law.

## CURRENT FITMENT INFORMATION

To the best of our knowledge, all the pictures and application information contained herein are accurate as of the date this catalog was approved for printing (November 2023). Because some models had not yet been released at the time, it was not possible to provide application information for these vehicles. Therefore, whenever a part is listed as fitting "to present" this would apply to models that had been able to verify application for by catalog press date ONLY. Please check with your KPMI® dealer or account representative for verification of the latest 2023 model year applications.

## NOTICES

All KPMI® valve guides, standard valves, and spring kits are intended for use as OEM replacement parts, exceeding OEM specifications in terms of durability and or expected cyclical life. Oversize valves are intended for racing vehicles with planned use on closed courses.

### KIBBLEWHITE® PRECISION MACHINING, INC.

**Billing:** 4320 Coast Hwy 1  
Pacifica, CA 94044

**Shipping:** 371 Princeton Ave  
Half Moon Bay, CA 94019

**Machine Shop:** 580-H Crespi Dr  
Pacifica, CA 94044

**Phone:** (650) 557-2046 **Fax:** (650) 359-8574

[www.kpmi.us](http://www.kpmi.us)

[www.facebook.com/kpmusa](http://www.facebook.com/kpmusa)

**FX: 650-359-8574**



**WWW.KPMI.US**



# OUR BUSINESS IS PERFORMANCE

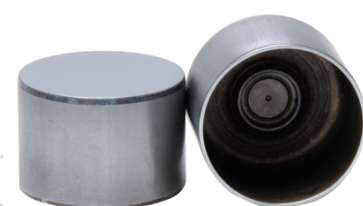
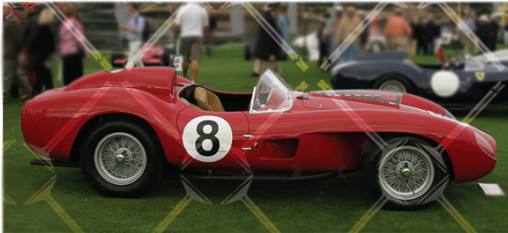
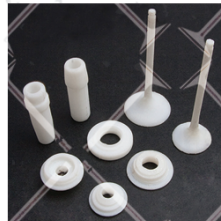

## KIBBLEWHITE PRECISION MACHINING INC.

**BILLING:** 4320 COAST HWY 1 ~ PACIFICA, CA 94044

**SHIPPING:** 371 PRINCETON AVE ~ HALF MOON BAY, CA 94019

**MACHINE SHOP:** 580-H CRESPI DR ~ PACIFICA, CA 94044

**PH:** 650-557-2046 - [SALES@KPMI.US](mailto:SALES@KPMI.US)

**WWW.KPMI.US - [FACEBOOK.COM/KPMUSA](https://www.facebook.com/kpmusa)**