



CAM LOCK FITTINGS



- Stainless steel rings, arms & pins.
- Most complete line of polypropylene couplings available.
- Versatile — interchangeable with all types of cam lever couplers.
- Precision molded insures a uniform and accurate fit.
- Durable- Polypropylene is glass reinforced for rugged strength and durability.
- Smooth operating finger rings are designed for easy opening of cam levers.
- Complete series of 1/2", 3/4", 1", 1 1/4", 1 1/2", 2", 3" and 4" NPT thread. • BSP threads available 1" - 3" sizes (excluding 1 1/4").
- Economical and superior in performance.
- Standard with EPDM gaskets. Buna "N", and FKM (viton) also available.

PART	A	B	C	D	E	F	GASKET	PLUG	CAP
1 1/2"	\$ 3.95	\$ 10.00	\$ 10.00	\$ 10.00	\$ 3.95	\$ 3.95	\$ 1.00	\$ 3.95	\$ 10.00
2"	\$ 4.50	\$ 12.50	\$ 12.50	\$ 12.50	\$ 5.25	\$ 5.25	\$ 1.50	\$ 5.25	\$ 12.50
3"	\$ 11.00	\$ 21.00	\$ 21.00	\$ 21.00	\$ 14.00	\$ 13.75	\$ 2.00	\$ 10.95	\$ 21.00
4"	\$ 16.25	\$ 41.00	\$ 41.00	\$ 41.00	\$ 16.25	\$ 16.25	\$ 2.95	\$ 10.75	\$ 29.75

Poly Cam Locks 3/4" to 4" are stocked for pipe thread or hose barb applications. We also carry a wide selection of regular sprayer fittings, clamps and valves.

FLANGE FITTINGS



SIZE	PART A	PART D	COUP	ELBOW	TEE	BARB T	CROSS	CLAMP	MPT	FMPT	HB	90 HB	GASK
1"	\$ 3.95	----	\$ 3.25	\$ 4.35	\$ 4.00	\$ 4.95	\$ 11.75	\$ 6.35	\$ 1.35	\$ 2.60	\$1.20	\$1.40	\$1.50
2"	\$ 5.10	----	\$ 8.25	\$ 7.25	\$ 8.40	----	\$ 21.00	\$ 7.25	\$ 7.95	\$ 7.95	\$3.25	\$5.75	\$1.00
220	\$ 5.75	\$14.00	\$ 9.25	\$ 7.35	\$ 8.45	\$ 9.25	\$ 21.00	\$ 8.00	\$14.10	\$14.10	\$3.25	\$5.75	\$1.00
3"	\$11.80	\$26.95	\$10.95	\$34.50	\$39.50	\$20.00	\$ 46.50	\$ 11.00	\$22.70	\$ 22.75	\$9.50	\$25.50	\$1.50



BANJO PUMPS AND SEAL KITS

PART #	MODEL#	DESCRIPTION	PRICE
200P6PRO	200P6PRO	2" POLY PUMP INTEK 6.5 HP BRIGGS	\$ 350.00 SALE
222I6PRO	222I6PRO	2" CAST PUMP 5.9HP INTEK BRIGGS	\$ 575.00 SALE
12000A	200P6PRO	IMPELLER/SEAL KIT	\$ 66.95 SALE
12999A	200P6PRO	SEAL KIT	\$ 47.95 SALE
15999	222I6PRO	SEAL KIT	\$ 42.95 SALE



GIVE US A CALL FOR ALL YOUR SPRAYER AND TRANFER FITTING NEEDS!



AG SPRAY HOSE EPDM



SIZE	PRESSURE RATING	PRICE PER FOOT
1/4"	200 (AG 200)	\$.45
3/8"	300 (AG 300)	\$.65
1/2"	300 (AG 300)	\$.85
5/8"	300 (AG 300)	\$.85
3/4"	300 (AG 300)	\$ 1.20
1"	300 (AG 300)	\$ 1.30
1 1/4"	200 (AG 200)	\$ 2.80
1 1/2"	200 (AG 200)	\$ 3.65
2"	200 (AG 200)	\$ 4.65
3/8"	EVA TUBING (NH3)	\$.32
1/2"	EVA TUBING (NH3)	\$.40



Apache hose products are made to withstand the toughest challenges. We source our products from the industry's top suppliers so we're able to deliver the highest quality products, customized to your particular application.

FERTILIZER TRANSFER HOSE

YELLOW REG.

Light weight, flexible, rugged suction/discharge hose which has good chemical resistance and is excellent for transferring fertilizer solutions, septic solutions, pesticides, and is Lasso® resistant. Its corrugated polyethylene helix serves as a scuff strip, making it durable and easy to handle.

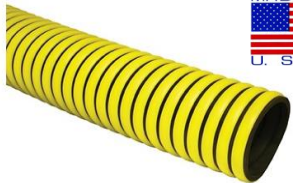

SIZE	PSI	DESCRIPTION	PRICE PER FT	50' ROLL
1"	80	YELLOW REG.	\$ 1.55	\$ 70.00
1 1/4"	70	YELLOW REG.	\$ 1.80	\$ 82.50
1 1/2"	60	YELLOW REG.	\$ 2.10	\$ 97.50
1 1/2"	100	ENFORCER HD	\$ 2.95	\$ 135.00
2"	60	YELLOW REG.	\$ 2.70	\$ 122.50
2"	100	ENFORCER HD	\$ 3.75	\$ 170.00
3"	50	YELLOW REG.	\$ 5.85	\$ 265.00
3"	85	ENFORCER HD	\$ 6.60	\$ 300.00
4"	70	ENFORCER HD	\$ 15.00	\$ 682.50

ENFORCER HD

Hose is Stronger and more dimensionally stable than Fertilizer Solution hose due to its polyester braided reinforcement. The EPDM tube has good chemical resistance, and is excellent for transferring fertilizer solutions, septic solutions and pesticide. Its corrugated polyethylene helix serves as a scuff strip, making it durable and easy to handle.



We offer this hose by the foot, 50' and 100' lengths. Call us for the bulk discounted price for 50' or more!



HOSE CLAMPS



Standard clamps have 9/16" band and housing are made of 300 series stainless steel. A 5/16" hex head screw is 300 series stainless steel. The 9/16" band width offers greater sealing area. One-piece, spot weld free housing.

SIZE	WORM STYLE	T BAND
1/4"	\$.70 EA.	-----
3/8"	\$.80 EA.	-----
1/2"	\$.80 EA.	-----
5/8"	\$.90 EA.	-----
3/4"	\$.90 EA.	-----
1"	\$ 1.10 EA.	-----
1 1/4"	\$ 1.25 EA.	(TC162)- \$ 5.45 EA. SALE
1 1/2"	\$ 1.25 EA.	(TC193)- \$ 5.50 EA. SALE
2"	\$ 1.30 EA.	(TC231)- \$ 5.75 EA. SALE
3"	\$ 1.75 EA.	(TC343)- \$ 6.00 EA. SALE
4"	\$ 1.95 EA.	(TC438)- \$ 11.90 EA. SALE
5"	\$ 3.50 EA.	-----
6"	\$ 3.75 EA.	-----



- * 304 Stainless steel construction.
- 304 Stainless steel bolt with silver plated nut to prevent seizing.
- 360° sealing surface.
- Ideal for high torque applications.
- Strong, positive connections where ordinary hose clamps fail.
- Nylon lock nut feature.
- T-bolt design.
- 3 spot welds for extra strength.



ACE SPRAYER PUMPS



MODEL	SPECIFICATION	PORT SIZE NPT	TYPE	PRICE
FMC-HYD-204	MAX FLOW 85GPM / MAX 100 PSI	1 1/4" IN / 1" OUT	HYD (4GPM)	\$ 680 SALE
FMC-HYD-206	MAX FLOW 135GPM/ MAX 120 PSI	1 1/2" IN / 1 1/4" OUT	HYD (7GPM)	\$ 695 SALE
FMC-200-HYD-210	MAX FLOW 180GPM / MAX 80 PSI	2" IN / 1 1/2" OUT	HYD(10GPM)	\$ 820 SALE
FMC-200F-HYD-304 FLANGE	MAX FLOW 240GPM / MAX 120 PSI	M300F IN / M220F OUT	HYD(13GPM)	\$ 890 SALE
FMCS-205F-HYD-304 FLANGE	MAX FLOW 240GPM / MAX 120 PSI	M300F IN / M220F OUT	HYD(13GPM)	\$ 945 SALE
GE-660-HONDA	MAX FLOW 110GPM / MAX 120PSI	1 1/2" IN / 1 1/4" OUT	GAS MOTOR	\$ 1275 SALE

CALL US FOR ALL YOUR PUMP PART NEEDS!



HYPRO SPRAYER PUMPS



MODEL	SPECIFICATION	PORT SIZE NPT	TYPE	PRICE
6500C (NON-GLY)	6 ROLLER MAX 21GPM / MAX 300 PSI	3/4" IN/OUT	ROLLER/PTO	\$ 139 SALE
6500XL (GLYPHOSATE)	6 ROLLER MAX 21GPM / MAX 300 PSI	3/4" IN/OUT	ROLLER/PTO	\$ 415 SALE
7560C (NON-GLY)	8 ROLLER MAX 22GPM / MAX 300PSI	3/4" IN/OUT	ROLLER/PTO	\$ 175 SALE
7560XL (GLYPHOSATE)	8 ROLLER MAX 22GPM / MAX 300PSI	3/4" IN/OUT	ROLLER/PTO	\$ 495 SALE
7700C (NON-GLY)	7 ROLLER MAX 22GPM / 200PSI	3/4" IN/OUT	ROLLER/PTO	\$ 179 SALE
7700XL (NON-GLY)	7 ROLLER MAX 22GPM / 200PSI	3/4" IN/OUT	ROLLER/PTO	\$ 505 SALE
9303C-HM1C	MAX 114 GPM / MAX 130 PSI	1 1/2" IN / 1 1/4" OUT	HYD(13GPM)	\$ 700 SALE
9305C-HM3C	MAX 173 GPM / MAX 120 PSI	2" IN / 1 1/2" OUT	HYD(19GPM)	\$ 1190 SALE
9306C-HM1C-3U	MAX 283 GPM / MAX 125 PSI	M300F IN / M220F OUT	HYD(13GPM)	\$ 920 SALE
9306C-HM3C-3U	MAX 322 GPM / MAX 125 PSI	M300F IN / M220F OUT	HYD(24GPM)	\$ 965 SALE



12 VOLT ELECTRIC DIAPHRAM PUMPS



PART #	GPM / AMPS	IN/OUT SIZE	PRICE EA.
8009541236D	1.0 / (6)	3/8" FMPT	\$ 80.00
8000543250ND	1.8 / (7)	3/8" FMPT	\$ 129.00
2088343500ND	3.3 / (10)	1/2" MPT	\$ 119.00
55372F163AND	5.3 / (25)	1/2" FMPT	\$ 190.00

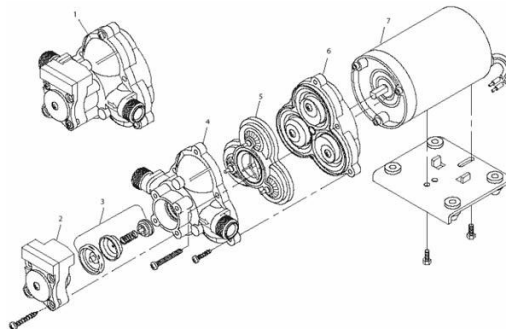



PACER TRANSFER PUMPS

PART#	SIZE	DESCRIPTION	PRICE
SE2PLE550	2"	2" POLY PUMP W/ 550 BRIGGS ENGINE	\$ 239 SALE
SE2ULE950	2"	2" POLY PUMP W/ 950 OHV BRIGGS ENGINE	\$ 289 SALE
SE2RLE5HC	2"	2" POLY PUMP W/ HONDA GX160 ENGINE	\$ 560 SALE
SE3SLE6VCP	3"	3" POLY PUMP W/ 6.5HP BRIGGS ENGINE	\$ 420 SALE
SE3SLE6HCP	3"	3" POLY PUMP W/ HONDA GX200 ENGINE	\$ 589 SALE
P-58-0704 12	ALL	SEAL KIT W/ O-RING	\$ 25.95 SALE
P-58-0704 30	2"	3 VANE IMPELLER	\$ 23.95 SALE
P-58-0706 30	2"	5 VANE IMPELLER	\$ 23.95 SALE
P-58-0975 30	3"	4 VANE IMPELLER	\$ 23.95 SALE

We Have Many Other Pumps And Parts In Stock!

Pacer Pumps are well suited for transferring water, fertilizer and most other agricultural chemicals. Their most popular uses are for irrigation, transfer, spraying, feeding of livestock and for use on nurse tanks.

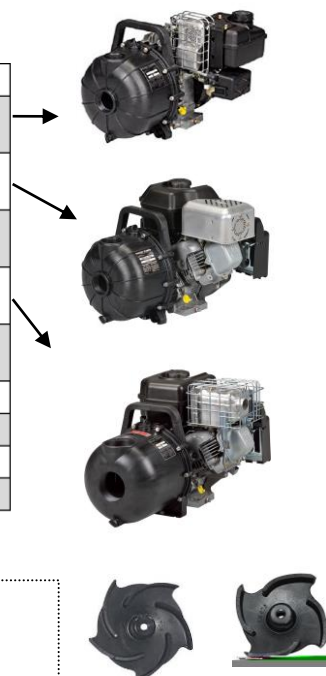

CHEMICAL ENDUCTION SYSTEM

PART #	TANK SIZE	VALVE	PRICE
337816402BYP	40 GALLON	2"	\$ 1,250 SALE
337816403BYP	40 GALLON	3"	\$ 1,300 SALE
337816602BYP	60 GALLON	2"	\$ 1,325 SALE
337816603BYP	60 GALLON	3"	\$ 1,435 SALE

*2" or 3" bypass educator plumbing system allows for direct filling of sprayer tank when not educating chemicals

*CycloRinse and ProClean bottle rinse prevent cross contamination of chemicals

*40 or 60 gallon , full draining, cone-bottomed tank for a 20:1 ratio with 800 or 1200 gallon sprayers



BANJO MANIFOLD INDUCTOR SYSTEM

MIS220	2" FULL PORT IN/OUT ASSEMBLED	\$ 315 SALE
MIS300	3" FULL PORT IN/OUT ASSEMBLED	\$ 595 SALE

*VALVE AND FITTING FROM TANK NOT INCLUDED

- Installed After Pump; Suction Completely Empties Inductor Tank.
- Keeps Tank Free Of Chemical Residue.
- Easily Assembles With Manifold Connections.



SEE PAGES 22-23 FOR A LIST OF CAMLOCKS AND HOSE FOR YOUR SPRAYER RIG!



QJ SPRAYER DROPS

PART #	LENGTH	DESCRIPTION	PRICE EA.
21353-6-15-NYB	15"	15" DROP QJ 1/4"NPT	\$ 7.55 SALE
21353-6-24-NYB	24"	24" DROP QJ 1/4"NPT	\$ 7.65 SALE
QJ1/4T-NYB	1/4" FMPT	QJ ADAPTER SINGLE	\$ 1.90 SALE
QJ8600-1/4-NYB	1/4"FMPT X QJ	1/4" FMPT SINGLE SWIVEL	\$ 4.65 SALE
QJ8600-2-1/4-NYB	1/4"FMPT X QJ	1/4" FMPT DOUBLE SWIVEL	\$ 5.60 SALE





SPRAYER NOZZLES



Tee Jet EXTENDED RANGE

PART #	PRICE EACH
XR8003VS	\$ 4.45 SALE
XR8004VS	\$ 4.45 SALE
XR8005VS	\$ 4.45 SALE
XR8006VS	\$ 4.45 SALE
XR8008VS	\$ 4.45 SALE
XR11002VS	\$ 4.45 SALE
XR11003VS	\$ 4.45 SALE
XR11004VS	\$ 4.45 SALE
XR11005VS	\$ 4.45 SALE
XR11006VS	\$ 4.45 SALE
XR11008VS	\$ 4.45 SALE
XR11010VS	\$ 5.50 SALE

-Excellent spray distribution over a wide range of pressures: 15-60 psi.

-Ideal for rigs equipped with sprayer controllers.

-Reduces drift at lower pressures, better coverage at higher pressures.



HYPRO "LOW DRIFT"

PART #	PRICE EACH
LD110-02	\$ 3.75 SALE
LD110-025	\$ 3.75 SALE
LD110-03	\$ 3.75 SALE
LD110-04	\$ 3.75 SALE
LD110-05	\$ 3.75 SALE
LD110-06	\$ 3.75 SALE
LD110-08	\$ 3.75 SALE

- Significantly reduces spray drift, widening the operational window.
- Has a balanced droplet size for effective, on-target spraying.



TURBO "TWIN JET" Tee Jet

Dual outlet design produces two 110° flat fan spray patterns using the patented technology from the Turbo TeeJet nozzle. The angle between each spray pattern is 60° forward and back.

Best suited for broadcast spraying where superior leaf coverage and canopy penetration is important.

PART #	PRICE EACH
TTJ60-11002VP	\$ 5.00 SALE
TTJ60-110025VP	\$ 5.00 SALE
TTJ60-11003VP	\$ 5.00 SALE
TTJ60-11004VP	\$ 5.00 SALE
TTJ60-11005VP	\$ 5.00 SALE
TTJ60-11006VP	\$ 5.00 SALE
TTJ60-11008VP	\$ 5.00 SALE



NOZZLE SCREENS



PART #	MESH	PRICE EACH
8079 PP 50	50 (RED)	\$.85 SALE
8079 PP 80	80 (BLUE)	\$.90 SALE
8079 PP 100	100 (GREEN)	\$.85 SALE

NOZZLE CAPS

PART #	TIP APPL.	PRICE EACH
25610-NYR	XR, LD, TT	\$.80 SALE
25597-NYR	AI, TJ60, TJ	\$.80 SALE
QJ4676-1/4	1/4" FPT	\$ 1.60 SALE
19843 NYR	BLANK	\$ 1.60 SALE
19438 EPR	GASKET	\$.55 SALE



AVAILABLE COLORS: BLACK, WHITE, RED, BLUE, GREEN, YELLOW AND BROWN. COLORS MAY VARY IN STOCK.

TURBO Tee Jet

- Tapered edge wide angle flat pattern for uniform coverage.
- Large, round free passages to minimize clogging.
- Excellent corrosive resistance.
- Larger droplets for less drift.

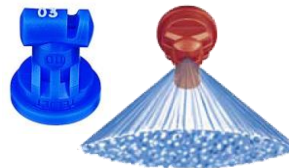

PART #	PRICE EACH
TT11002VP	\$ 4.25 SALE
TT110025VP	\$ 4.25 SALE
TT11003VP	\$ 4.25 SALE
TT11004VP	\$ 4.25 SALE
TT11005VP	\$ 4.25 SALE
TT11006VP	\$ 4.25 SALE
TT11008VP	\$ 4.25 SALE

Tee Jet AI "XR"

- A perfect balance of drift control and coverage
- Wide operating pressure range of 15-90 PSI
- Air-induction design enhances coverage of larger droplets through air inclusion
- Compact design avoids damage
- Easy to remove pre-orifice for quick maintenance
- AI XR tips fit all Quick TeeJet® standard flat spray caps



PART #	PRICE EACH
AIXR110002VP	\$ 4.70 SALE
AIXR1100025VP	\$ 4.70 SALE
AIXR11003VP	\$ 4.70 SALE
AIXR11004VP	\$ 4.70 SALE
AIXR11005VP	\$ 4.70 SALE
AIXR11006VP	\$ 4.70 SALE

Tee Jet "TURBO" T INDUCTION TIP

- All acetal construction for excellent chemical and wear resistance
- Tapered flat 110° spray pattern.
- Large droplets are produced through a venture air aspirator resulting in less drift.
- Pressure Range: 15-100 PSI.
- Use CP25597 Quick TeeJet® cap.

Required For Use With Dicamba Resistant Beans!



PART #	PRICE EACH
TT111002VP	\$ 7.20 SALE
TT1110025VP	\$ 7.20 SALE
TT111003VP	\$ 7.20 SALE
TT111004VP	\$ 7.20 SALE
TT111005VP	\$ 7.20 SALE
TT111006VP	\$ 7.20 SALE
TT111008VP	\$ 8.20 SALE
TT111010VP	\$ 8.20 SALE

Hypro "GUARDIAN AIR"

*Optimized for performance and high productivity, especially for application rates around 10 GPA

*Provides better coverage with more drops per gallon compared to other common

PART #	PRICE EACH
GA110-015	\$ 6.20 SALE
GA110-02	\$ 6.20 SALE
GA100-025	\$ 6.20 SALE
GA110-03	\$ 6.20 SALE
GA110-035	\$ 6.20 SALE
GA110-04	\$ 6.20 SALE
GA110-05	\$ 6.20 SALE























*ALL NOZZLES ARE PRICED WITH OUT CAPS!



SPRAYER BOOM BODIES



	PART #	DIAM.	BRAND	TYPE	# NOZZLES	PRICE EA.	
	311 375 NYB	3/8"	TJ	SINGLE	1	\$ 5.60 SALE	
	312 375 NYB	3/8"	TJ	DOUBLE	1	\$ 5.60 SALE	
	311 500 NYB	1/2"	TJ	SINGLE	1	\$ 5.60 SALE	
	312 500 NYB	1/2"	TJ	DOUBLE	1	\$ 5.60 SALE	
	311 750 NYB	3/4"	TJ	SINGLE	1	\$ 5.60 SALE	
	312 750 NYB	3/4"	TJ	DOUBLE	1	\$ 5.60 SALE	
	24230 1 785 NYB	3/4"	TJ	90 TURRET	3	\$ 14.50 SALE	
	24230 2 785 NYB	3/4"	TJ	T TURRET	3	\$ 14.50 SALE	
	QJ363 750 1 NYB	3/4"	TJ	SINGLE	3	\$ 13.25 SALE	
	QJ363 750-2-NYB	3/4"	TJ	DOUBLE	3	\$ 13.25 SALE	
	QJ363 1000 1 NYB	1"	TJ	SINGLE	3	\$ 13.25 SALE	
	QJ363 1000-2- NYB	1"	TJ	DOUBLE	3	\$ 13.25 SALE	
	QJ364 750 1 NYB	3/4"	TJ	SINGLE	4	\$ 13.25 SALE	
	QJ364 750-2-NYB	3/4"	TJ	DOUBLE	4	\$ 13.25 SALE	
	QJ364 1000 1 NYB	1"	TJ	SINGLE	4	\$ 13.25 SALE	
	QJ364 1000-2-NYB	1"	TJ	DOUBLE	4	\$ 13.25 SALE	
	QJ365 750 1 NYB	3/4"	TJ	SINGLE	5	\$ 13.25 SALE	
	QJ365 750-2-NYB	3/4"	TJ	DOUBLE	5	\$ 13.25 SALE	
	QJ365 1000 1 NYB	1"	TJ	SINGLE	5	\$ 13.25 SALE	
	QJ365 1000-2-NYB	1"	TJ	DOUBLE	5	\$ 13.25 SALE	
	QJ363 3/4 NYB	3/4"	TJ	3/4" PIPE	3	\$ 10.65 SALE	
	QJ363 1 NYB	1"	TJ	1" PIPE	3	\$ 10.65 SALE	
	QJ363F-1-NYB	1"	TJ	1" PIPE	3	\$ 15.80 SALE	
	QJ17560 3/4 NYB	3/4"	TJ	3/4" PIPE	1	\$ 3.50 SALE	
	QJ17560 1 NYB	1"	TJ	1" PIPE	1	\$ 3.50 SALE	
	21953-EPR	ALL	TJ	DIAPHRAM	EPDM	\$.40 SALE	
	4620 VI	ALL	TJ	DIAPHRAM	VITON	\$ 1.00 SALE	
	21950 2 NYB	ALL	TJ	2# CHECK	CAP	\$ 2.50 SALE	
	21950 5 NYB	ALL	TJ	5# CHECK	CAP	\$ 2.50 SALE	
	21950 10 NYB	ALL	TJ	10# CHECK	CAP	\$ 2.50 SALE	
	4200-0010	ALL	HYPRO	4# CHECK	CAP	\$ 2.25 SALE	
	4200-0020	ALL	HYPRO	8# CHECK	CAP	\$ 2.25 SALE	
	4200-0004E	ALL	HYPRO	DIAPHRAM	EPDM	\$.50 SALE	
	4200-0040V	ALL	HYPRO	DIAPHRAM	VITON	\$ 1.45 SALE	
	4221N-B123V-00	3/4"	HYPRO	3/4" PIPE	1	\$ 4.50 SALE	
	4221N-B124-00	1"	HYPRO	1" PIPE	1	\$ 3.00 SALE	
	4223N-B324-00	1"	HYPRO	1" PIPE	3	\$ 10.00 SALE	
	4223N-B524-00	1"	HYPRO	1" PIPE	5	\$ 10.00 SALE	
	QJ111 3/4	3/4"	TJ	CLAMP	RND	\$ 3.05 SALE	
	QJ111SQ 3/4	3/4"	TJ	CLAMP	SQUARE	\$ 3.50 SALE	
	QJ111SQ 1	1"	TJ	CLAMP	SQUARE	\$ 3.75 SALE	
	QJ111SQ 1 1/4	1 1/4"	TJ	CLAMP	SQUARE	\$ 5.25 SALE	
	QJ111SQ 1 1/2	1 1/2"	TJ	CLAMP	SQUARE	\$ 6.25 SALE	

***PLEASE SPECIFY CHECK VALVE PRESSURE WHEN ORDERING.**

EXAMPLE: TEE JET YELLOW= 2# / BLACK= 5# OR 10#

HYPRO RED= 7# / ORANGE= 4#

***PRICES SUBJECT TO CHANGE WITHOUT NOTICE.**

CHEMICAL GLOVES
-15 MIL NITRILE
-LARGE
\$ 2.95 PER PAIR



SPRAY TANK CLEANER / RINSING AGENT

Spray tank equipment flush for agriculture chemical use.
Flushes all working parts.
32 OZ.

\$ 9.95 EACH



CALIBRATION CONTAINER
-100 OZ.
\$ 16.95 EA. SALE



SPRAYER CONTROL KITS AND VALVES

PART #	BRAND	DESCRIPTION	PRICE EACH
144A 1	TEEJET	3/4" DIRECTO VALVE	\$ 105.00 SALE
144P 1	TEEJET	3/4" DIRECTO VALVE HD	\$ 145.00 SALE
145H 1	TEEJET	1" DIRECTO VALVE	\$ 239.00 SALE
PKAB144 1 KIT	TEEJET	REPAIR KIT EPDM	\$ 19.95 SALE
PKAB144P 1 KIT	TEEJET	REPAIR KIT EPDM (P)	\$ 28.95 SALE
PKAB145H KIT	TEEJET	REPAIR KIT EPDM (H)	\$ 34.95 SALE
15163 NYB	TEEJET	144A1 COIL ONLY	\$ 35.50 SALE
45632	TEEJET	144P COIL ONLY	\$ 99.00 SALE
18605	TEEJET	145H COIL ONLY	\$ 78.00 SALE
144A-1-3	TEEJET	3/4" CONSTANT FLOW	\$ 145.00 SALE
PKAB14413 KIT	TEEJET	144A-1-3 REPAIR KIT	\$ 23.50 SALE
344BEC 23C	TEEJET	3/4NPT ELEC. BALL VALVE	\$ 209.00 SALE
344BEC 24C	TEEJET	1NPT ELEC. BALL VALVE	\$ 209.00 SALE
344BEC 33C	TEEJET	3/4" NPT 2 DIRECTION BALL	\$ 259.00 SALE
344BEC 34C	TEEJET	1" NPT 2 DIRECTION BALL	\$ 259.00 SALE
344BEC 2FC	TEEJET	1" FLANGE ELEC. BALL	\$ 259.00 SALE
35-50049 (244C)	TEEJET	3/4 REMOTE REG. VALVE	\$ 115.00 SALE
EV075	BANJO	3/4"NPT ELC. BALL VALVE	\$ 249.00 SALE
EV100	BANJO	1"NPT ELEC. BALL VALVE	\$ 249.00 SALE
EV125	BANJO	1 1/4" ELC. BALL VALVE	\$ 249.00 SALE
EV150	BANJO	1 1/2" ELC. BALL VALVE	\$ 365.00 SALE
EV204FP	BANJO	2" ELEC. BALL VALVE	\$ 385.00 SALE
453BEC2NFC	TEEJET	1" DIRECTO MANIFOLD BANK 3	\$ 660.00 SALE
453BEC2N4C	TEEJET	1"NPT MANIFOLD BANK 3	\$ 660.00 SALE
2380	TIR	3 SECT. SPRAY KIT COMPLETE 3/4"	\$ 449.00 SALE
2040LWP3	TIR	3 SECT. SPRAY KIT COMPLETE 1"	\$ 549.00 SALE
2500B	TIR	12 VOLT 3/4" SOLENOID VALVE	\$ 79.50 SALE
1999A.1	TIR	12 VOLT 1" SOLENOID VALVE	\$ 119.00 SALE
1506A	TIR	PRESSURE ADJ. VALVE	\$ 89.50 SALE
2202A	TIR	1/4" ELEC. SOLENOID VALVE	\$ 69.50 SALE
2204A	TIR	1/4" 3 WAY ELEC. SOLENOID VALVE	\$ 79.50 SALE



PLEASE CALL FOR SPECIFICATIONS!



BALL VALVES

PART #	SIZE	DESC.	PRICE EA.
UV050	1/2"	1/2"FMPT UNION VALVE	\$ 12.75 SALE
V050	1/2"	1/2"FMPT 4 BOLT VALVE	\$ 24.75 SALE
UV075	3/4"	3/4"FMPT UNION VALVE	\$ 12.75 SALE
V075	3/4"	3/4"FMPT 4 BOLT VALVE	\$ 24.75 SALE
UV100FP	1"	1"FMPT UNION VALVE	\$ 15.95 SALE
V100FP	1"	1"FMPT 4 BOLT VALVE	\$ 27.50 SALE
UV125FP	1 1/4"	1 1/4" FMPT UNION VALVE	\$ 27.50 SALE
V125FP	1 1/4"	1 1/4"FMPT 4 BOLT VALVE	\$ 35.00 SALE
UV150FP	1 1/2"	1 1/2"FMPT UNION VALVE	\$ 27.00 SALE
V150	1 1/2"	1 1/2"FMPT 4 BOLT VALVE	\$ 35.00 SALE
UV200FP	2"	2"FMPT UNION VALVE	\$ 35.00 SALE
V200FP	2"	2"FMPT 6 BOLT VALVE	\$ 49.50 SALE
V300FP	3"	3"FMPT 6 BOLT VALVE	\$ 110.00 SALE
V400	4"	4"FMPT 6 BOLT VALVE	\$ 259.00 SALE

FILTER ASSEMBLIES

PART #	SIZE	DESC.	PRICE EA.
LSTM050-50	1/2"	1/2" T STRAINER 50 MESH	\$ 13.50 SALE
LS050-60	1/2"	1/2" Y STRAINER 60 MESH	\$ 22.50 SALE
LST075-50	3/4"	3/4" T STRAINER 50 MESH	\$ 23.95 SALE
LS075-60	3/4"	3/4" Y STRAINER 60 MESH	\$ 22.55 SALE
LST100-50	1"	1" T STRAINER 50 MESH	\$ 23.95 SALE
LS100-40	1"	1" Y STRAINER 40 MESH	\$ 22.55 SALE
LST125-50	1 1/4"	1 1/4" T STRAINER 50 M	\$ 48.00 SALE
LS125-40	1 1/4"	1 1/4" Y STRAINER 40 M	\$ 22.55 SALE
LST150-50	1 1/2"	1 1/2" T STRAINER 50 M	\$ 48.00 SALE
LS150-50	1 1/2"	1 1/2" Y STRAINER 50M	\$ 50.00 SALE
MLS222-50	2"	FLANGE Y STRAINER	\$ 85.50 SALE
LS200-50	2"	2" Y STRAINER 50 MESH	\$ 50.00 SALE
MLS300-50	3"	3" FLANGE Y STRAINER	\$ 315.00 SALE
LMS300-50	3"	3" Y STRAINER 50 MESH	\$ 330.00 SALE

