

## AGCO CORN HEAD PARTS

PART #	MODEL	DESCRIPTION	PRICE EA.
ADA400	1977-89 BLACK HEAD	GATHERING CHAIN	\$ 84.00
ADA500	HUGGER / 3000 SER.	GATHERING CHAIN	\$ 76.00 SALE
A71359125	HUGGER / 3000 SER.	LOWER IDLER 8T	\$ 19.50
A70595084	1977-89 BLACK HEAD	LOWER IDLER 8T	\$ 16.95
AP71432138	HUGGER / 3000 SER.	UPPER DRIVE SPROCKET	\$ 21.50
AP70577247	1977-89 BLACK HEAD	UPPER DRIVE SPROCKET	\$ 29.50
70586591	AC 1972-89 BLACK HEAD	ROLL FLUTE (SET OF 4) 2H	\$ 62.00
KHC110	HUGGER / 3000 SER.	ROLL FLUTE (3 USED PER ROLL) 3H	\$ 22.00

## DRAGO GATHERING CHAINS

PART #	MODEL	DESCRIPTION	PRICE EA.
<b>WN-DR10120</b>	LEGACY, SERIES I & II, DG9060, DG9340, DG11030, GT SERIES	56 LINKS / 7 LUGS / CHROME PINS (NOT 20")	\$ 76.95 SALE
<b>WN-DR10010</b>		11 TOOTH LOWER IDLER SPROCKET (LESS BEARING)	\$ 69.95
<b>A-DR8250</b>		8 TOOTH UPPER DRIVE SPROCKET	\$ 69.95
<b>WN-DR11030</b>	LEGACY, SERIES I & II, DG9060, DG9340, DG11030, GT SERIES	ROLL KNIFE (USA) 4 PER ROLL	\$ 41.00 SALE

## GERINGHOFF CORN HEAD PARTS

PART #	MODELS	DESCRIPTION	PRICE EA.
AGH100	ROTO DISC 30" / NORTH STAR 30" / MS CORNSTAR 30"	CHAIN 76 LINK 6 LUG	\$ 87.95
AGH200	ROTO DISC 30" / NORTH STAR 30" / MS CORNSTAR 30"	CHAIN 76 LINK 9 LUG	\$ 87.95
AGH400	ROTO DISC 20" / NORTH STAR 20" / MS CORNSTAR 20"	CHAIN 72 LINK 9 LUG	\$ 87.95
C501217	ALL	POLY WEAR BLOCK (2 PER ROW)	\$ 3.40
AO32033	ALL 20" HEADS	13 TOOTHLOWER IDLER SPROCKET	\$ 41.00
A032012GH	ALL 30" HEADS	17 TOOTHLOWER IDLER SPROCKET	\$ 41.00
K501060	ROTA DISC HEADS	CUTTING DISC (15 PER SHAFT)	\$ 33.50
K502351	NORTH STAR	ROLL KNIFE (HEAT TREATED TUNGSTEN) USA	\$ 35.95 SALE
K502300	NORTHSTAR	ROLL KNIFE BOLT KIT (6 PER ROLL)	\$ 2.20
K501251	ROTA DISC HEADS	ROTOR KNIFE W/ TUNGSTEN EDGE	\$ 22.95
K501839	ROTA DISC HEADS	STUBBLE CUTTER	\$ 37.95

## YETTER STALK DEVISTATOR

Today's hybrids develop tough stalks that can destroy expensive tires and tracks on equipment. The 5000 Stalk Devastator™ saves tires and tracks by knocking over, stomping, and crushing stalks while leaving them attached, speeding up the cornstalk breakdown process and improving field conditions for spring planting.

### Features

- Prevents damage to tires, tracks, wires, and hydraulic hoses on combines, trucks, tractors, and implements
- Knocks over and crushes stalks for faster decomposition and microbial breakdown of residue
- Preserves residue cover, reducing soil erosion and keeping stalks in place in windy conditions
- Quick and easy to install with mounting kits for most corn head models
- Features spring-loaded, adjustable down pressure
- Solid steel construction ensures reliability and durability
- Will not interfere with most head cart trailers
- Rollers can be locked up for transport of head or when not in use.

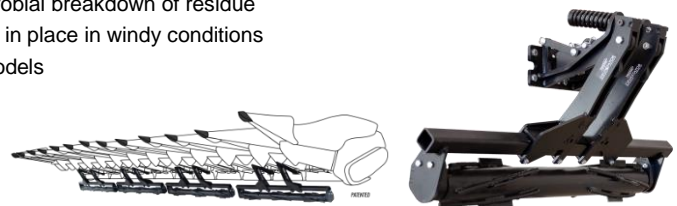

PART #	MODEL / ROW # / LIST PRICE	PRICE EA.
5000-025	JD 643/693/606C / 6 ROW 30" (\$4300 LIST)	CALL FOR DISCOUNT PRICING
5000-026	JD 893, 608C / 8 ROW 30" (\$5700 LIST)	CALL FOR DISCOUNT PRICING
5000-027	JD 612C / 12 ROW 30" (\$8500 LIST)	CALL FOR DISCOUNT PRICING
5000-006	CIH 3208,3408 / 8 ROW 30" (\$5700 LIST)	CALL FOR DISCOUNT PRICING
5000-017	DRAGO 830/ 8 ROW 30" / (\$5700 LIST)	CALL FOR DISCOUNT PRICING
WP209PPB5	BEARING	\$ 26.50 EA.

Please Call For Availability.  
PRICES SUBJECT TO CHANGE WITHOUT NOTICE!

# CASE IH CORN HEAD PARTS

## 800 SERIES



PART #	DESCRIPTION	PRICE EA.
WN-AN102009	GATHERING CHAIN IMP. (BLACK PIN)	\$ 39.95
WN-AN102448	LOWER IDLER SPROCKET	\$ 14.95
KBP199497	UPPER DRIVE SPROCKET (800 ONLY)	\$ 18.95
A-176291C91	DECK PLATE LH	\$ 27.95
A-176292C91	DECK PLATE RH	\$ 27.95
A-176304C2	ROLL KNIFE (4 PER SHAFT REQUIRED)	\$ 19.50



## 900-1000 SERIES



PART #	DESCRIPTION	PRICE EA.
WN-176301C1	ROLL SHAFT COUPLER(1000,3200,3400)	\$ 22.00
WN-199371C5	RH ALUMINUM SUPPORT	\$ 139.00
WN-199372C5	LH ALUMINUM SUPPORT	\$ 139.00
CF176286	IDLER SUPPORT LH	\$ 41.95
CF176287	IDLER SUPPORT RH	\$ 41.95
A-1306207C1	WEED KNIFE (WELD ON)	\$ 4.50
WN-352552A1	LH STALK ROLL AUGER W/ BEARING	\$ 100.00
WN-352551A1	RH STALK ROLL AUGER W/ BEARING	\$ 100.00
WN-327913A2	BEARING SHIELD	\$ 6.75
WN-1989222C2	STALK ROLL BEARING	\$ 22.50
WN-199293C5	STALK ROLL SHAFT	\$ 88.95
S176307H	STALK ROLL PIN	\$ 4.50 SALE
WN-1327205C1	RH ROLL SHAFT SUPPORT	\$ 51.95
WN-1327204C1	LH ROLL SHAFT SUPPORT	\$ 51.95
CS1306150	IDLER TENSION SPRING	\$ 6.50
A-199097C3	EAR SAVER (RUBBER) 800/900/1000/GVL	\$ 5.00
WN-AN102009	GATHERING CHAIN IMP.	\$ 39.95
WN-AH136671	GATHERING CHAIN CHROME PIN	\$ 58.00
WN-AN102448	LOWER IDLER SPROCKET	\$ 15.95
WN-199497C1	UPPER DRIVE SPROCKET	\$ 19.95
WN-1347176C1	CHAIN GUIDE	\$ 20.00
A-199382C1	RH DECK PLATE	\$ 26.00
A-199381C1	LH DECK PLATE	\$ 26.00
K900	STALK ROLL KNIFE TUNGSTON (4 NEEDED PER SHAFT)USA	\$ 16.95
IH1000SRKVH	1000 SER. ROW UNIT KIT	\$ 585 SALE

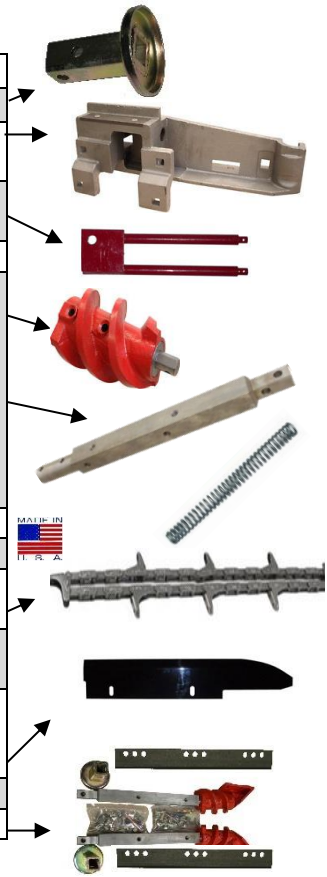

## 2200/3400 SERIES



PART #	DESCRIPTION	PRICE EA.
WN-86977538	2000 SER. ROLL KNIFE PLATE (2 PER ROLL)	\$ 46.00
K87598741	3000 SER. ROLL KNIFE (4 PER ROLL) USA	\$ 25.95
C-A84635	LOWER IDLER SPROCKET 3200-3400	\$ 17.95
AP86837081	2200, 2400, 3200 SN <YCS023090, 3400 SN<YCS039041 DRIVE SPROCKET	\$ 21.95
WN-AN102009	EARLY 2200-3400 GATHERING CHAIN	\$ 39.95
WN-86979313	2200, 2400, 3200, 3400 (< 2010)	\$ 43.95
AIH400	6 LUG GATHERING CHAIN 3200, 3400 (2011>)	\$ 69.00
CF86369	LOWER IDLER SUPPORT 2200-3400	\$ 40.95
A-87029139	LOWER IDLER STRAP 2200-3400	\$ 34.00
A-86583948	TENSIONER SPRING	\$ 8.00
P86526475	EAR SAVER (RUBBER)	\$ 7.95

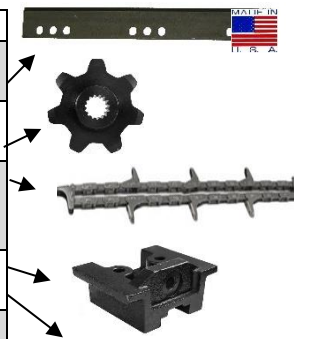

## 2600/4200/4400



PART #	DESCRIPTION	PRICE EA.
K84499693	ROLL KNIFE USA (4 PER SHAFT)	\$ 33.95
AIH500	CHROME PIN GATHERING CHAIN	\$ 74.95



Please Call For Availability.  
PRICES SUBJECT TO CHANGE WITHOUT NOTICE!

# JOHN DEERE CORN HEAD PARTS

## 40-90 SERIES

PART #	DESCRIPTION	PRICE EA.
P144503	LATE 40 / 90 IDLER STRAP	\$ 22.00
WN-H84479	40 SER. IDLER SUPPORT	\$ 19.95
CH153898	90 SER. IDLER SUPPORT	\$ 27.50
P104096	ADJUSTMENT SLEEVE	\$ 5.95
CN61703	IDLER TENSION SPRING	\$ 5.50
PO8H4219	IDLER TENSION BOLT 5/8 X 10.5"	\$ 6.50
WN-AN102448	LOWER IDLER (NON GREASABLE)	\$ 15.95
A-H118945	STEEL CHAIN GUIDE	\$ 18.50
CH151211	CAST CHAIN GUIDE	\$ 31.00
P104090R	RH TAPERED FLUTE STALK ROLL	\$ 89.50 SALE
P104091L	LH TAPERED FLUTE STALK ROLL	\$ 89.50 SALE
TFHWKIT	5/16 X 2 & 1/2 X 2 ROLL PIN SET (1 PER ROLL)	\$ 1.10
A150138 USA	RH STRAIGHT FLUTE STALK ROLL	\$ 130.00 SALE
A150139 USA	LH STRAIGHT FLUTE STALK ROLL	\$ 130.00 SALE
TFHWKIT	5/16 X 2 & 1/2 X 2 ROLL PIN SET (2 PER ROLL)	\$ 1.05
CF150690	RH KNIFE ROLL SEGMENT (2 PER ROLL)	\$ 100.00
CF150691	LH KNIFE ROLL SEGMENT (2 PER ROLL)	\$ 100.00
WN-AH136671	GATHERING CHAIN CHROME PIN	\$ 58.00
WN-AN102009	GATHERING CHAIN IMP	\$ 39.95
P148320R	RH KNIFE ROLL SHAFT	\$ 99.00
P148321L	LH KNIFE ROLL SHAFT	\$ 99.00
KRK90C	COMPLETE KNIFE ROLL KIT	\$ 695 PER ROW SALE
P148223	90 SER. INNER EAR SAVER (SN<676000)	\$ 4.25
P166582	40 SER. / 90 SER. EAR SAVER (SN 676001>)	\$ 4.25
WN-AH209794	ROW UNIT GEAR BOX ASSEMBLY	\$ 1400.00
WN-H85252	UPPER DRIVE SPROCKET	\$ 18.95
A-AH204016	LATE IDLER GREASE CAP	\$ 7.25
CAH101219	LATE 40/ 90 GREASABLE IDLER SPROCKET	\$ 14.95
A-N102068 JD	40 SER. RH DECK PLATE (SN <466450)	\$ 25.00
A-N102069 JD	40 SER. LH DECK PLATE (SN <466450)	\$ 25.00
WN-H94952	LATE 40 SER. DECK PLATE (SN 466451>)	\$ 20.95
CH773	90 SER. HYD DECK PLATE HF	\$ 92.50
CH270	90 SER. STATIONARY HF (NON-HYD)	\$ 35.00
CH140825	COVER FOR HYD DECK PLATE	\$ 69.00

## JD 600 SERIES

WN-AH234578	606-618C (SN 745101>) GATHERING CHAIN (6 TOOTH)	\$ 69.95
WN-AH208978	606-618C (SN <745100) GATHERING CHAIN (8 TOOTH)	\$ 69.95
AP233287	606-618C (SN <745100) UPPER DRIVE SPROCKET	\$ 39.95
AP231386	606-618C (SN <745100) LOWER IDLER SPROCKET	\$ 39.50
AP10258	606-618C (SN 745101>) UPPER DRIVE SPROCKET	\$ 33.95
AH18770	606-618C (SN 745101>)) LOWER IDLER SPROCKET	\$ 24.95
B6203RL	BEARING ONLY FOR AP231386	\$ 5.50
CH24566	606-618C (SN <745100) RH BEVELED DECK PLATE	\$ 36.00
CH17618	606-618C (SN <745100) LH BEVELED ADJ. DECK PLATE	\$ 59.00
CH237437	606-618C, 708-718C (SN 745101>) RH DECK PLATE	\$ 55.50
CH234656	606-618C, 708-718C (SN 745101>) LH ADJ. DECK PLATE	\$ 76.50
CH235031	LH POLY CHAIN GUIDE 606-618C,(SN 745101>)	\$ 34.95
CH235033	RH POLY CHAIN GUIDE 606-618C,(SN 745101>)	\$ 34.95
CN61703	IDLER TENSION SPRING	\$ 4.95
CH215634	606-618C (SN <745100) IDLER SUPPORT	\$ 29.95
A-H237885	LH CAST IDLER SUPPORT (SN 745101>)	\$ 34.00
A-H237841	RH CAST IDLER SUPPORT (SN 745101>)	\$ 34.00
G228917	606-618C SNOUT WEAR STRIP (4 PER SNOUT)	\$ 3.95
CFJDP	POLY DIVIDER PATCH KIT	\$ 27.00
CF326324	600C / 700C EAR SAVER INNER (5/16" THICK)	\$ 12.50
CF326325	600C / 700C EAR SAVER OUTER (5/16" THICK)	\$ 12.50
H148121	CAST SNOUT TIP	\$ 26.95
K15470	600C STALK ROLL LH (SN:745101>)	\$ 379 SALE
K15471	600C STALK ROLL RH (SN:745101>)	\$ 379 SALE

Please Call For Availability.  
PRICES SUBJECT TO CHANGE WITHOUT NOTICE!

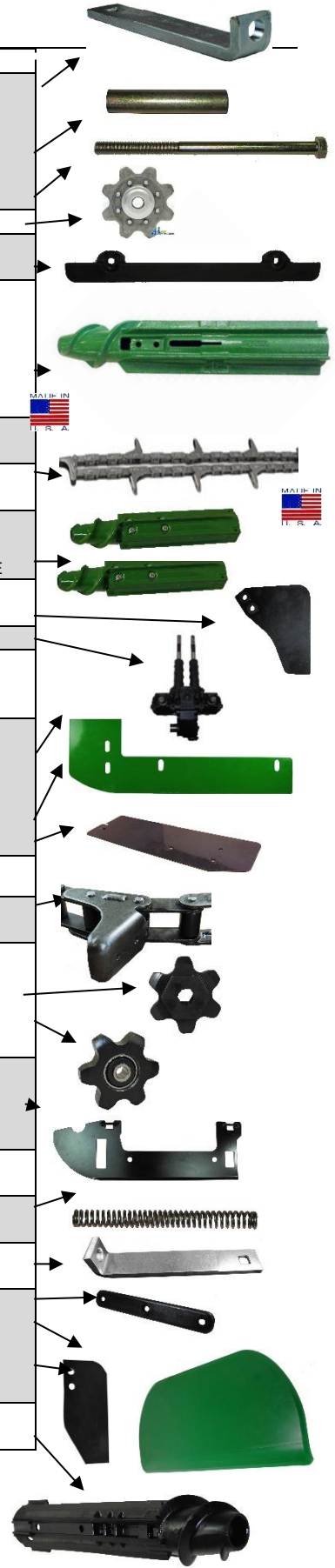
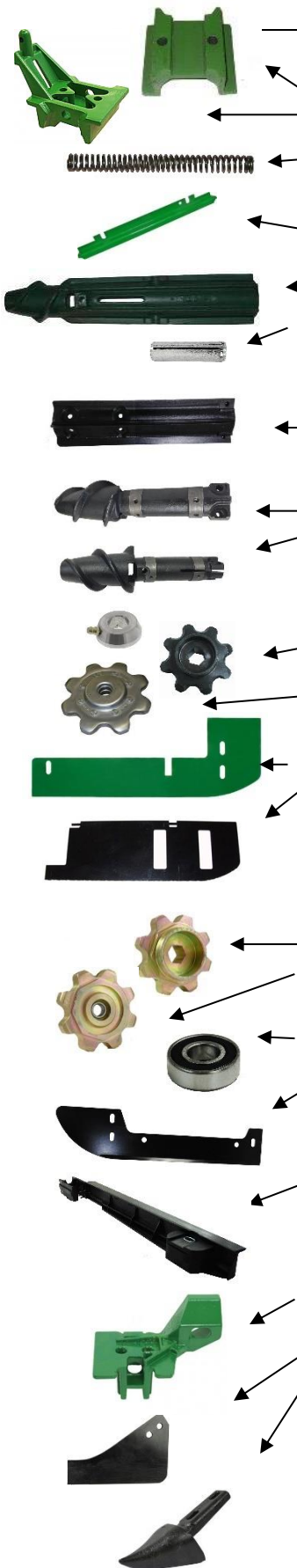

## NEW HOLLAND CORN HEAD PARTS



PART #	MODEL	DESCRIPTION	PRICE EA.
WN-102009	974, 996, 96C, 98C, 98D (<2010)	GATHERING CHAIN	\$ 39.95
AIH500	99C, 980CF, 980CR	GATHERING CHAIN (CHROME PIN)	\$ 74.95
AN102448	974, 996, 96C, 98C,	LOWER IDLER NON GREASABLE (USA)	\$ 15.95
A84635	98D	LOWER IDLER NON GREASABLE	\$ 17.95
AP86837081	98D (<2013)	SPLINED DRIVE SPROCKET (7 TOOTH)	\$ 22.95
A-84347361	98D (2013>)	ROUND BORE DRIVE SPROCKET (7 TOOTH)	\$ 38.00
K84499693	99C, 980CF, 980CR	ROLL KNIFE (4 PER SHAFT) USA	\$ 33.95
K87598741	98D	ROLL KNIFE (4 PER SHAFT)	\$ 25.95
CF86369	974 (SN <536454), 96C, 98C, 98D, 996	LOWER IDLER SUPPORT	\$ 39.95

## STALK STOMPERS FOR CORN HEADS



PART #	MODEL TO FIT:	DESCRIPTION	PRICE PER ROW
NDYSA- //	CNH, JD, GERINGHOFF	SINGLE ASSEMBLY COMPLETE	\$ 329 SALE
NDYSA-DR	DRAGO	6 ROWS OR MORE W/ MOUNTS	\$ 329.- \$400 SALE
NDYSA-DR1	DRAGO SER. 1 & 2	SINGLE ASSEMBLY COMPLETE	\$ 329.00 SALE
99203	ALL	TORSION SPRING	\$ 17.00 SALE
99216	ALL	SPRING LOADED PULL PIN	\$ 10.00 SALE

**\*FREIGHT CHARGES MAY BE APPLIED TO NON-STOCKED STOMPER KITS!**

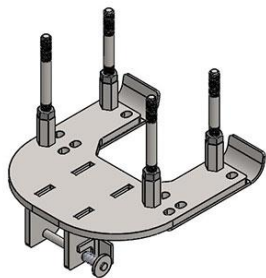

GERINGHOFF

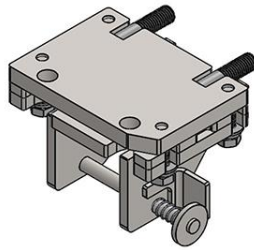

JD 40/90 SERIES

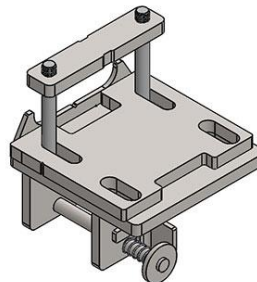

JD 600 SERIES

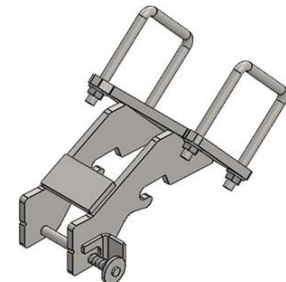

CNH 4000 SERIES

- One pin quick release
- Standard three position mount
- Case hardened inner and outer bushings
- Mounts using existing gearbox bolts
- Optional storage mounts
- Black or yellow poly option
- 14" twin row shoes available



Please Call For Availability.  
PRICES SUBJECT TO CHANGE WITHOUT NOTICE!