

CMOS Active Filter for Dual Purpose like Low Pass and High Pass Filter for Biomedical System

Raj Kumar Tiwari¹, Shiksha Jain²

*Physics and Electronics Department, Dr. R.L.A. University, Ayodhya, U.P, India¹
Institute of Engineering and Technology, Dr. R.L.A. University, Ayodhya, U.P, India²*

Abstract - This paper shows the new illustration for low power low noise dual purpose active filter. It is necessary to design the advanced monitoring products used in biomedical system. The demand of biomedical monitoring product is increasing day to day in Bio-Health Organization. Low power and low noise and high bandwidth are the necessary factors that play the major role in biomedical system. The proposed structure of active filter is designed for dual purpose as a Low Pass Filter and Band Pass Filter with the help of complementary compound CMOS pair. It behaves as an active element to enhance the band of the filter in the range of μHz to KHz with very low power consumption of 199.81pW. It is simulated on 180nm Cadence Virtuoso too.

Key words- Complementary Compound CMOS Pair; Low power consumption; High low frequency bandwidth.

I. INTRODUCTION

Major challenges in health monitoring of human is increasing day to day rapidly. Because the life style of human is totally depended on the natural and non natural artificial products like: food, cosmetic items, etc. Health monitoring product plays the major role to recognize and reduce the health problem of human. These products work on biomedical frequency with low power low noise. Biomedical signals have very low frequency signals used in biomedical applications [1] [2]. In the biomedical applications, low pass filter and band pass filter play the most important role to detect the biomedical signals like:

ERG (Electro Retinography) signals, ECG (Electro Cardiography) signals, EEG (Electro Encephalography) signals and EMG (Electro Myography) signals etc. shown in following “fig-1”.

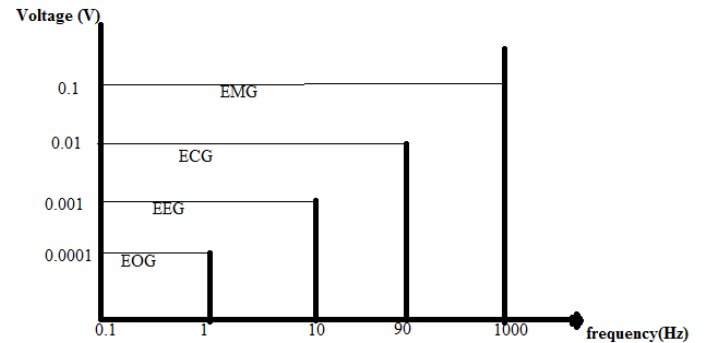

Fig-1 Frequency Range for Biomedical Signals

Mostly, biomedical monitoring systems are based on analog signal processing due to continuous signal. It consists of the two major blocks like preamplifier and filter. The type of filter may be low pass filter or band pass filter or both depend on the measuring product. The general diagram of biomedical system is shown in “fig-2”.

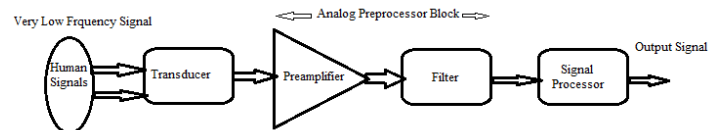

Fig-2 General Diagram of Biomedical System

In all biomedical systems, preamplifier is a major part to amplifying the weak input signal with negligible noise and low distortion. For example in electrocardiograph (ECG) measurement, the amplitude of preamplifier signals has to be processed approximately 100mV by a low pass filter [3] [4]. Filters employed in biomedical system are used for sensing bioelectrical signal.

In recent years, CMOS nanotechnology is very popular to design and implementation of high gain active filters and passive filters used in various applications for biomedical field. Now till various different techniques have been used to design active filters (low pass filter, high pass filter, band pass filter, band stop filter) with specific characteristics for biomedical portable devices. These techniques include switched-capacitor-based technique, gm-c transconductance techniques, Offset reduction techniques for full swing output, OTA using miller compensation techniques and multi tanh doublet technique etc. define in following references [5]-[9]. In 2017, M.Renuka has studied the circuit designing of active low pass filter for biomedical applications using OTA. This filter is based on fourth order cross coupled input structure. It provides 25dB gain with low power consumption of 600nW at 100Hz frequency. While, Puneet Kaushik propose the designing of CMOS low pass filter using OTA with the help of multi tanh doublet technique in 2018. It provide ECG frequency of 250Hz at 13.43nW low power consumption and EEG frequency of 200Hz at 9.4nW power consumption. The portable sensors used in biomedical system are mostly battery operated so it works on ultra low power and low noise. In this paper, we proposed the designing of filter using active component for low power, low noise with high frequency band. This proposed filter is based on complementary compound CMOS pair as an active component with RC network.

A. Complementary Compound CMOS Transistor

This transistor is innovative and design by my supervisor Professor Raj kumar Tiwari. It consists of two NMOS and PMOS transistor as a two CMOS inverter connect in the form of Darlington Pair. This type of transistor is very useful to enhance the bandwidth of the filter (for low frequency and high frequency both) with high gain and low power consumption. The source of 1st inverter is becomes the gate of 2nd inverter. Hence, 1st inverter is connected as a source follower and 2nd inverter act as a common source amplifier shown in “fig-3”. It has various advantages as compare the others [10][11][12][13].

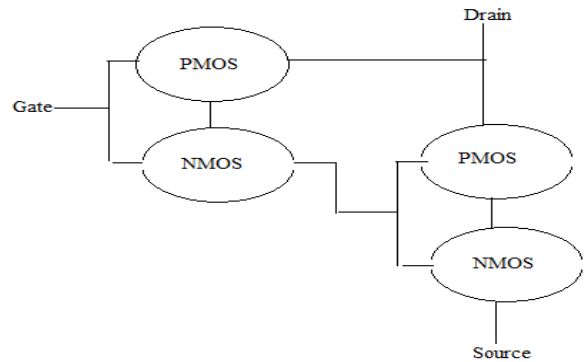

Fig-3 Model of Complementary Compound Pair

B. Importance of Filters

An ideal filter has some major characteristics like:

At fixed gain - amplitude response has unity.

Pass band - transition of frequency from low to high and high to low or pass all frequencies in this transition period.

Stop band - transition of frequency from high to low and low to high or stop all frequencies in this transition period.

Cut of frequency - at which the frequency response changes from pass-band to stop-band

Filters can be divided in four categories based on their operation. First category is Low pass filter (LPF) to pass the band of low frequency signals and stop the high frequency signals. Second Category is High pass filter (HPF) to pass the band of high frequency signals and stop the low frequency signals. Third category is Band pass filter (BPF) that allows passing the certain frequency range signals and stopping the other low frequency and high frequency signals. And last category is Band stop filter (BSF) that stops the certain frequency range signals and pass the other low frequency and high frequency signals. The frequency response of all separate operations is shown in “fig-4”.

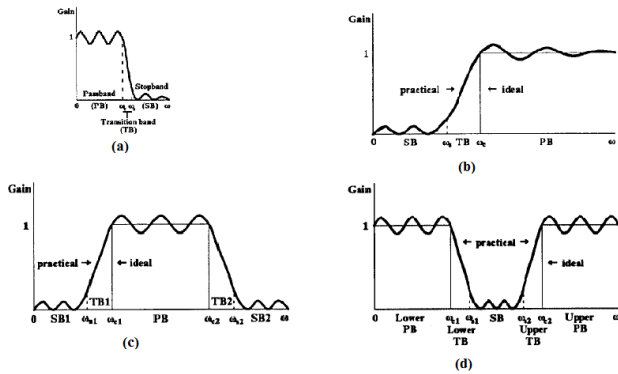

Fig-4 Standard Frequency Response of Active Filter

Filters have played the dominant role in all communication system to consider the wanted or required signal and reject or avoid the unwanted signal. It has many practical applications. A simple, single pole, low-pass filter (the integrator) or band pass filter is often used to stabilize amplifiers by rolling off the gain at higher frequencies where excessive phase shift may cause oscillations. In this paper, we have used complementary compound CMOS pair using amplifier as an active element to increase the band of frequency and reduce the power consumption of the filter.

II. PROPOSED DESIGN OF DUAL PURPOSE CMOS ACTIVE FILTER

This proposed design of active filter is applicable for the low frequency operations of band pass filter and low pass filter for biomedical application. It is based on CMOS nanotechnology and simulate on 180nm cadence virtuoso tool. The filter designing consist of two complementary compound CMOS pair, simple current mirror, and two RC networks. Complementary compound CMOS pair (RKTG Pair) are connected in parallel behave as a cascaded CMOS amplifier. The output of second complementary compound pair is the input of first complementary compound pair with RC network. The whole circuit has connected to the simple current mirror, which provides high current gain. Simple current mirror can be replaced by the advanced CMOS current mirror. The circuit diagram of proposed low power low noise dual purpose CMOS active filter is shown in “fig-5”. This type of CMOS amplifier using RKTG Pair applied in any type of filter is suitable to enhance the size of bandwidth, voltage amplification, signal isolation, low power consumption etc.

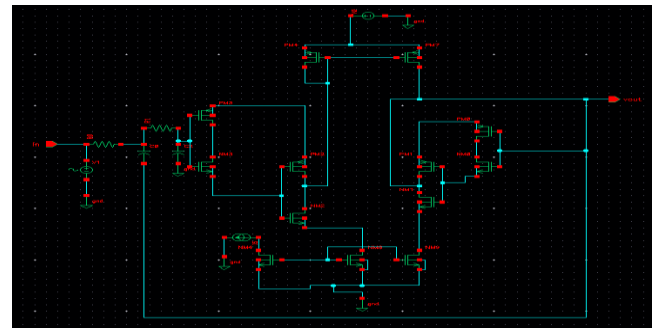

Fig-5 Proposed Designing of Dual Purpose CMOS Active Filter

The proposed dual purpose active filter can be used as a low pass filter as well as band pass active filter for low frequency applications such as Digital signal processing, Analog signal processing and Biomedical signal processing etc. by decreasing the value of capacitor up to μF at very low input supply 1mV shown in following table-1.

Table-1

Input Supply = 1mV 50Hz

S.No.	R1/R2	C1/C2	Low Cut off frequency (f_1)	High Cut off frequency (f_2)
1	1K Ω	10nF	584.27 μHz	11.44KHz
2	1K Ω	100nF	57.03 μHz	116.62Hz
3	1K Ω	500nF	11.67 μHz	23.45Hz
4	1K Ω	1 μF	5.97 μHz	11.68Hz

This type of designed filter behaves as a highest band of low frequency up to μHz to Hz at the low value of capacitor. In this period, second order low pass filter behave as a band pass filter to pass the band of low frequency. Hence, it can be valuable to design biomedical portable devices for biomedical applications. This type of CMOS active filter can be designed as a high pass filter and band stop filter with the help of changing the value of passive components used in filter. This proposed second order low pass filter is simulated on 180nm cadence virtuoso tool and show in next section with simulation results.

III. SIMULATION RESULT DISCUSSION

The proposed design circuit is simulated on 180nm Cadence Virtuoso Tool for the implementation. To measure the specification of the proposed filter, we consider the transient analysis, AC analysis, Noise analysis and power measurement

etc. “Fig-6” and “fig-7” show the low cut off frequency of 57.08μHz and high cut off frequency of 116.62Hz at the value of capacitor is 100nF and the value of resistor is 1KΩ. This frequency range is very higher for low frequency signals processing like biomedical signal processing with high amplification up to 4.84V at 1mV input supply.

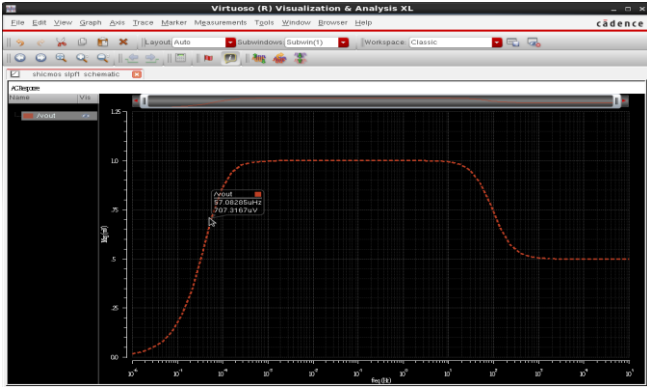

Fig-6 Transients Response for Lower Cut off Frequency (57.08μHz)

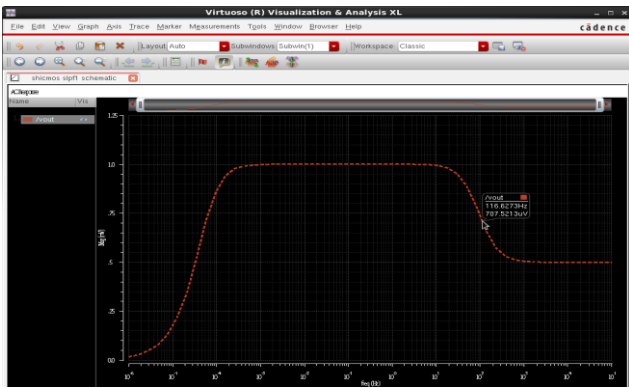

Fig-7 Transients Response for Higher Cut off Frequency (116.62Hz)

The proposed dual purpose active filter is having a low noise. It is measured by the noise analysis (Output noise analysis, Input noise analysis, and transfer noise analysis) through the simulation process shown in “fig-8”, “fig-9” and “fig-10”. Its represent the 119.19mV/sqrt output noise, 174.42mV/sqrt input noise at the low cut off frequency 57.08μHz.

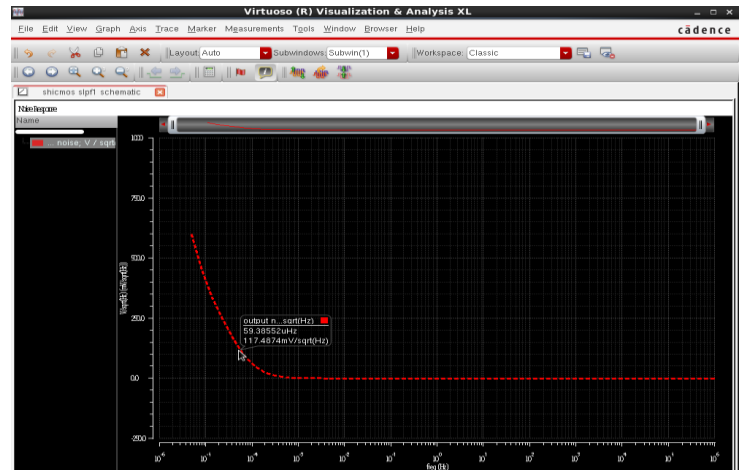

Fig-8 Output Noise Analysis of Dual Purpose Active Filter Using CADENCE TOOL

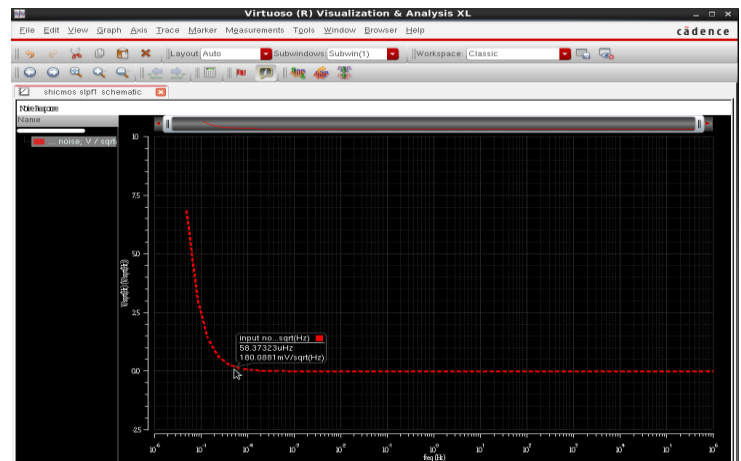

Fig-9 Input Noise Analysis of Dual Purpose Active Filter Using CADENCE TOOL

The frequency of the biomedical signal is specific for every health monitoring system such as ECG monitoring system operates on 250 Hz, EEG monitoring system operates on 200 Hz. In this filter design, the CCA (Complementary Compound Pair using Amplifier) is the basic building of the dual purpose active filter for biomedical portable devices. CCA is useful to enhance the bandwidth of the filter with ultra low power consumption in 199.9pW shown in “fig-11”. It is very low power consumption at the low frequency bio signal.

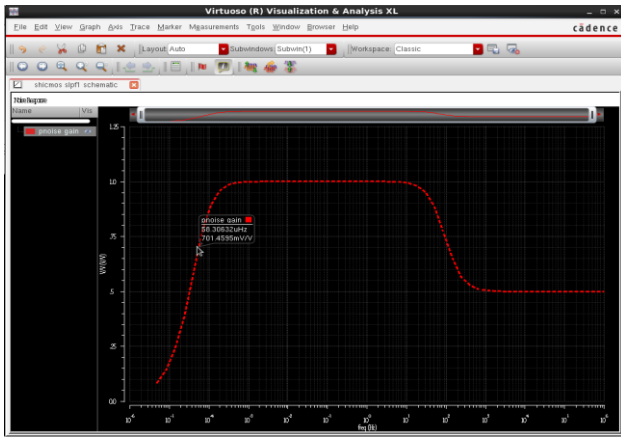

Fig-10 Transfer Noise Analysis of Dual Purpose Active Filter Using CADENCE TOOL

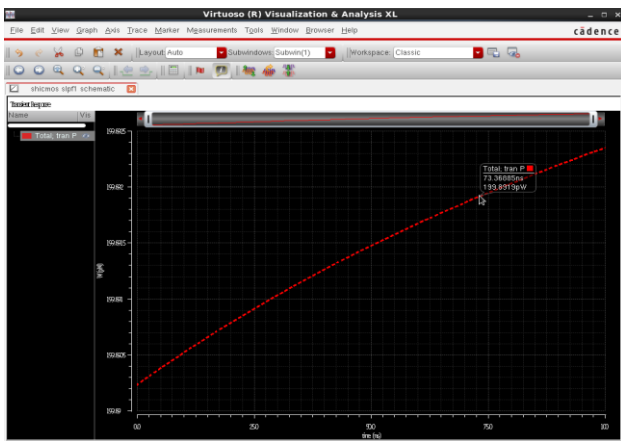

Fig-11 Power Analysis of Dual Purpose Active Filter Using CADENCE TOOL

IV. CONCLUSIONS

In this design, the low power low noise Complementary Compound amplifier using complementary compound pair is used to design dual purpose active filter for biomedical applications such as EEG and ECG. The simulation results provide less than 200Hz cut off frequency for the low pass filter at capacitor value of 100nH and resistor value of 1KΩ. While at the same value of RC network, this filter behave as a band pass filter (low cut off frequency = 57.08μHz and high cut off frequency = 116.62Hz). The power consumption by whole designed filter is very low means 199.9pF. Comparison study with others is shown in following “table-2”.

Table-2

S.No	Technique	Gain	Frequency	Power Consumption
1	Operational Transconductance Amplifier [6]	0dB-3dB	Less than 10Hz	Very low
2	Cross Coupled Input Structure [7]	25dB	100Hz	600nW
3	Regenerative Feedback and Offset Reduction Technique [8]	20KHz Unity Gain Bandwidth	17Hz	249.7nW
4	Multi Tanh Doublet Technique[9]	-	250Hz 200Hz	13.43nW (ECG) 9.4nW (EEG)

V. ACKNOWLEDGE

The authors are thankful to University Grant Commission (U.G.C.), New Delhi to provide experimental facility 180nm cadence tools established in the Department of Physics and Electronics in VLSI lab provided under the Major Research Project No. (Project ID. MRP-MAJOR-ELEC-2013-31956).

REFERENCES

[1] Andras Timar and Marta Rencz , “Design issues of a low frequency low pass filter for medical applications using CMOS technology,”.

[2] Chun-Lung Hsu, Mean-Hom Ho, Yu-Kuan Wu and Ting-Hsuan hen, “Design of Low-Frequency Low-Pass Filters for Biomedical Applications,” IEEE, Circuits and Systems, pp. 690-695, December 2006.

[3] Edwin Cheng Mu Lim, Xiaodan Zou, Yuanjin Zheng, and Jun Tan, “Design of Low Power Low Voltage Biomedical Amplifier for Electrocardiogram Signal Recording,” IEEE Xplore, pp.191-194, 2007.

[4] Tan-Tan Zhang, Pui-In Mak, Mang-I Vai, Peng-Un Mak, Feng Wan and R. P. Martins, “An Ultra-Low-Power Filtering Technique

for Biomedical Applications,” IEEE, EMBS pp.1859-1862, August 30- September 3, 2011.

[5] Haidong Liu, Xiaohong Peng and Wuchen Wu, “Design of a Gm-C Low Pass Filter with Low Cut Off Frequency,” IEEE Microelectronics & Electronics, pp. 125-128, January 2009.

[6] Preeti R. Lawhale and Mayuri M.Soni, “Design of CMOS Based Low Pass Filter,” International Conference on Science and Technology for Sustainable Development, Kuala Lumpur, MALAYSIA, May 24-26, 2016.

[7] M. Renuka, B. Divya and B. Preethi, “ACTIVE LOW PASS FILTER FOR BIOMEDICAL APPLICATIONS,” INTERNATIONAL JOURNAL OF ENGINEERING SCIENCES & RESEARCH TECHNOLOGY, ISSN: 2277-9655, Impact Factor: 4.116, December 2017.

[8] K. Hari Priya, and Y.Mythreya, “Design of an Ultra-Low Power Band Pass Filter for Bio Medical Applications,” International Journal of Pure and Applied Mathematics, Vol. 118, No. 20, 2018, 2793-2798 ISSN: 1314-3395.

[9] Puneet Kaushik, and Mohit Jain, “DESIGN OF LOW POWER CMOS LOW PASS FILTER FOR BIOMEDICAL APPLICATION,” International Journal of Electrical Engineering & Technology (IJEET), Volume 9, Issue 5, September-October 2018,

[10] Raj Kumar Tiwari, Gaya Prasad, “CMOS Compound Pair Wide Band Bio-Amplifier,” Published in International Journal of Computational Engineering Research (IJCER), Vol.04, Issue 6, June-2014, pp. 57-62 ISSN (e): 2250-3005. Impact Factor: 1.145, (Computed by African Quality Centre for Journals).

[11] Gaya Prasad, Raj Kumar Tiwari, Shiksha Jain and Ganga Ram Mishra, “Simulation Study of CMOS Compound Pair Amplifier,” International Journal of Advance Research in Science and Engineering, Vol. 07, Special Issue No. 01, April 2018, Impact Factor (2018): 2.83. ISSN No.(o) 2319-8354, (P) 2319-8346.

[12] Raj Kumar Tiwari, Shiksha Jain, and Gaya Prasad, “Complementary Compound Push Pull Power amplifier for Wide Frequency Band Applications Using CMOS Nanotechnology,” International Conference on Electrical and Electronics Engineering (ICEE-2020), 978-1-7281-4/20/\$31.00©2020 IEEE.

[13] Shiksha Jain, “A Review: Performance Analysis of Voltage Controlled Differential Ring Oscillators Based On Delay Cell Using CMOS Nanotechnology,” International Journal of Research and Analytical Reviews (IJRAR- 2020), Vol. 7, Issue 1, February 2020, <http://doi.org/10.1729/Journal.23159>.



Professor Raj Kumar Tiwari was born in Faizabad (UP), India in 1960. He received B.Sc and M.Sc degree with scoring highest marks and awarded by Gold Medal in Allahabad University. He qualified JRF (CSIR) and also

obtained SRF (CSIR) in 1984. He obtained P.hd degree from Dr. RML Awadh University in Physics. He has placed on high positions like Former Director of I.E.T, Ex. Dean Faculty of Science, Ex. HOD in Department Of Physics and Electronics of Dr. R.L.A University Ayodhya. He has published more than 86 Research Papers in Journal and International/National Conferences. 13 Ph.D research scholar has awarded under his supervision. Currently he is working as a Professor in Physics and Electronics Department and Dean Student Welfare of Dr. Rammanohar Lohia Awadh University Ayodhya.



Shiksha Jain was born in Aligarh (UP), India in 1984. She received the B.Tech degree in Electronics & Communication Engineering from UP Technical University, Lucknow, U.P. India in 2005, M.Tech degree in Digital

Electronics from Gautam Budh Technical University, Lucknow, U.P. India in 2011, pursuing Ph.D in Electronics from Dr. Rammanohar Lohia Awadh University, U.P. India from 2018. Currently she is an assistant professor and head of the department of Electronics & Communication Engineering, Institute of Engineering and Technology, Dr. Rammanohar Lohia Awadh University, India. His research interest includes microprocessor, VLSI Design, Digital system and Electronics Circuit.