

Super Complete

U. S. Suggested Retail Price List
Jan-18

Phone: 260-665-2769

Fax: 260-665-3047

Email: iim@mobility-usa.com

www.mobility-usa.com

Quote: _____

P.O. _____

Bill To

Dealer: _____ Contact: _____

Address: _____

City: _____ State: _____ Zip: _____

Phone: _____ Fax: _____

Email: _____ Mark For: _____

Ship To Same as Bill To _____

Dealer: _____ Contact: _____

Address: _____

City: _____ State: _____ Zip: _____

Phone: _____ Fax: _____

Email: _____ Mark For: _____

Juditta Features and Specifications

- **Frame** - steel, grey painted with non-toxic epoxy powder paint
- **Upholstery** - breathable, fire-retardant, attaches to the seat with buttons, easily removable, and machine washable or wipeable
- **Headrest** - adjustable in height, angle, depth, and side to side; provides stability to the user without obstructing the lateral movement of the head; insuring proper alignment between head and trunk. Made out of a special anti-bacterial closed cell, highly resistant to external chemical agents.
- **Backrest** - gives a proper alignment to the trunk and doesn't generate any pressure on the spine; height adj; tilt 13°-38°
- **Armrest** - flip open to be positioned behind the backrest for easy transfer
- **Seat Bottom** - adjustable inclination of 10° to 35° due to gas springs, inclined by 10° to prevent user from sliding forward
- **Legrests** - corner protectors padded for knee, swing away leg support adjustable in height and angle to help the user to get close for transitioning
- **Footplates** - flip up and height adjustable, easy access to elevators and small rooms
- **Wheels** - 6.7" swivelling solid front and 12" or 22" solid rear, drum brakes are engageable with single control pedal, 3" anti-tip wheels



JUDIB30



JUDIB60

Super Ccomplete Options select one

Quantity	Part Number	Description	Price
		Juditta SC - includes frame, upholstery, legrests, calf pads & hardware, 3" armpads, headrest	
_____	JUDIB30-16	Juditta 16" seat with 12" rear wheels	\$3,835.00
_____	JUDIB30-18	Juditta 18" seat with 12" rear wheels	\$3,935.00
_____	JUDIB30-20	Juditta 20" seat with 12" rear wheels	\$4,035.00
_____	JUDIB60-16	Juditta 16" seat with 22" rear wheels	\$4,235.00
_____	JUDIB60-18	Juditta 18" seat with 22" rear wheels	\$4,335.00
_____	JUDIB60-20	Juditta 20" seat with 22" rear wheels	\$4,435.00

Upholstery select one

Part Number	Description	Price
_____ 171491	Breathable Upholstery 16"	N/C
_____ 171425	Breathable Upholstery 18"	N/C
_____ 171426	Breathable Upholstery 20"	N/C
_____ 100496	Wipeable Upholstery 16"	N/C
_____ 100497	Wipeable Upholstery 18"	N/C
_____ 100498	Wipeable Upholstery 20"	N/C

Positioning Options







Part Number	Description	Price
_____ G828	Abdominal Belt	\$85.00
_____ G834	Abduction Block	\$165.00

**Accessories**

Part Number	Description	Price
_____ G916-40	Padded Calf Strap alternative to calf pads 16"	\$245.00
_____ G916-45	Padded Calf Strap alternative to calf pads 18"	\$255.00
_____ G916-50	Padded Calf Strap alternative to calf pads 20"	\$265.00
_____ G824-R40	Reclinable Tray adj in tilt and depth 16"	\$355.00
_____ G824-R45	Reclinable Tray adj in tilt and depth 18"	\$355.00
_____ G824-R50	Reclinable Tray adj in tilt and depth 20"	\$355.00
_____ G896-40	Padded Removable Tray Covering 16"	\$105.00
_____ G896-45	Padded Removable Tray Covering 18"	\$105.00
_____ G896-50	Padded Removable Tray Covering 20"	\$105.00



Accessories Continued

Part Number	Description	Price	
<u> </u> G933	IV Pole	\$260.00	
<u> </u> J914	Footrest Lock	\$225.00	
<u> </u> J905	Hand Brakes - set for rear wheel lock	\$260.00	
<u> </u> G892-40	Removable Footplate Covering 16"	\$160.00	
<u> </u> G892-45	Removable Footplate Covering 18"	\$160.00	
<u> </u> G892-50	Removable Footplate Covering 20"	\$160.00	
<u> </u> J891	Tie Down Hooks Intended for forward-facing transport of the chair in a motor vehicle. Conforms with ISO 7176/19 and ANSI RESNA WC/19	N/C	
<u> </u> 171491	Extra Set of Breathable Upholstery 16"	\$550.00	
<u> </u> 171425	Extra Set of Breathable Upholstery 18"	\$550.00	
<u> </u> 171426	Extra Set of Breathable Upholstery 20"	\$550.00	
<u> </u> 100496	Extra Set of Wipeable Upholstery 16"	\$550.00	
<u> </u> 100497	Extra Set of Wipeable Upholstery 18"	\$550.00	
<u> </u> 100498	Extra Set of Wipeable Upholstery 20"	\$550.00	
<u> </u> LGSVC	Lift Gate Service For facilities without a loading dock	\$105.00*	

*Discounts do not apply

Client Measurements

A Back height: _____ F Lower leg length: _____
 B Chest depth: _____ G Head height: _____
 C Chest width: _____ H Arm height: _____
 D Seat depth: _____ Age: _____
 E Seat width: _____ Weight: _____

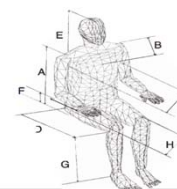

Dimensions

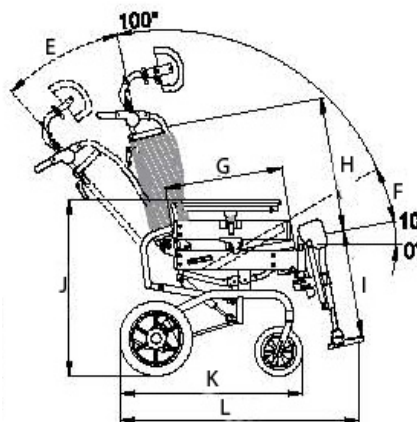
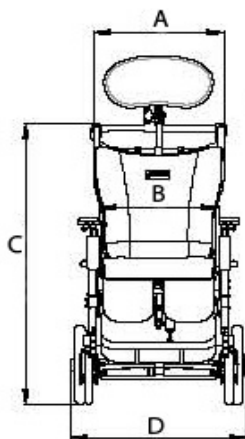

Measurements in Inches

Juditta	Size 16	Size 18	Size 20
Max Capacity	264.5 lbs	286.5 lbs	308.5 lbs
Unit Weight B30	84 lbs	86 lbs	88 lbs
Unit Weight B60	90 lbs	92.5 lbs	95 lbs
A	18.5	20.5	22.5
B	16	18	20
C	40.5 - 43	40.5 - 43	40.5 - 43
D B30	24.5	26	28
D B60	27	29	31
E	13° - 38°	13° - 38°	13° - 38°
F	10° - 35°	10° - 35°	10° - 35°
G	16,17,18,19	16,17,18,19	16,17,18,19
H	22 - 24.5	22 - 24.5	22 - 24.5
I	14.5 - 19	14.5 - 19	14.5 - 19
J	28 - 31.5	28 - 31.5	28 - 31.5
K	30.5	30.5	30.5
L	39.5	39.5	39.5
M B30	31	31	31
M B60	34	34	34
N	31	31	31

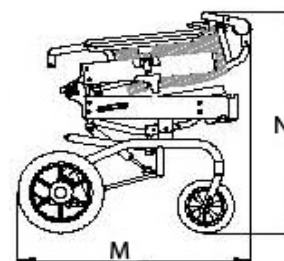

Note: All specification and prices are subject to change without notice. Prices listed are only valid if ordering with a chair.

For coverage information, verify the policy of the appropriate payer. It is recommended to contact Innovation In Motion with any questions regarding proper ordering of the chair at 1-260-665-2769.