

**SECTION  
K  
TECHNICAL  
STANDARDS**

**IMPBA OFFICIAL RULE BOOK**

## TECHNICAL STANDARDS

I - ENGINE, MOTOR & HULL CLASSIFICATIONS .....	K - 1
II - ENGINE/MOTOR DEFINITIONS & CLASSIFICATIONS .....	K - 1
Noise Rule.....	K - 1
III - HULL CLASSIFICATIONS.....	K - 2
Maximum weight and length rule.....	K - 2
Mono Hulls .....	K - 2
Hydro Hull .....	K - 4
IV - PROTESTS .....	K - 5
V - IMPBA APPROVED COURSES .....	K - 6
General.....	K - 6
1/4 Mile Oval Approved Course.....	K - 7
1/3 Mile Oval Approved Course.....	K - 7
1/16 Mile Approved Straightaway.....	K - 7
1/5 Mile Oval Electric Approved Course .....	K - 7
VI -SETTING UP IMPBA APPROVED COURSES .....	K - 8
Base Reference Points .....	K - 8
Buoy Locators .....	K - 8
Three Methods of Buoy Anchoring.....	K - 9
Course Dimensional Tolerances .....	K - 9
Documentation.....	K - 9
Sensor Location .....	K - 10
Timing Equipment.....	K - 10
Course Layout Figures.....	K - 11
Buoy Anchor Method Figures .....	K - 12
Transmitter Mounts Figure .....	K - 13
VII - RACE STARTING CLOCK OPERATIONS.....	K - 14
General Specifications .....	K - 14
Circular Clocks .....	K - 14
Digital Clock.....	K - 15

# TECHNICAL STANDARDS

## I - ENGINE, MOTOR and HULL CLASSIFICATIONS

The IMPBA will herein clearly define both engine and motor classes. Any changes to either will require approval twelve (12) months prior to January 1 they are to become effective. The only exception to this is if engine classes are so realigned that a currently legal size engine or plant becomes illegal. In this case, the change will require approval three (3) years prior to the January 1 it becomes effective.

## II - ENGINE/MOTOR DEFINITIONS and CLASSIFICATIONS

### A. Displacement

The cubic inch displacement of a power plant shall be the sum total of the displacement of all cylinders in the power plant. The cubic inch displacement of multi-cylinder engines, two or more engines driving attached together and two or more engines driving separate propellers will be added together to determine the total displacement and thus the class the power will run in. To determine engine class, read calculated engine displacement to three decimal places, drop all remaining figures.

### B. Internal Combustion Nitro Engine Classes

<u>Class</u>	<u>Cubic Inch Displacement</u>	<u>Metric Class</u>
A	0.000 thru 0.129	2.1 CC
B	0.130 thru 0.219	3.5 CC
C	0.220 thru 0.300	4.9 CC
D	0.301 thru 0.458	7.5 CC
E	0.459 thru 0.670	11.0 CC
F	0.671 thru 1.830	30.0 CC

Formulas:  $CC \times .061 = CID$ ,  $CID \text{ divided by } .061 = CC$

These classes will be Auto Ignition (Glow Plug / Diesel )  
and Alternate Fuels (Methanol / Nitro Methane)

Note: For Large Scale Gasoline engine classes see section "I", Large Scale Gasoline.

### C. Steam Engine Classes

Class H - .000 thru 1.8308 Cu. In. - Up to 30.0 CC

### D. Electric Powered Classes

Refer to section J, Fast Electric, for Classes.

### E. Fuel restrictions

The use of Tetra Nitro Methane or Hydrazine is illegal in all phases of model boating controlled by IMPBA. Any member found using these would be banned from IMPBA for one year. In addition, he will have to reimburse to IMPBA the entire fuel analyzing costs prior to being allowed to rejoin this organization.

### F. Noise Rule

At all IMPBA sanctioned events all boats MUST meet the following conditions, and boat operators accept the included mandates.

1. A commercially available noise measurement device (Radio Shack or equivalent) must be used. The noise measurement device will be set to the "A" weighted measuring scale, fast response.
2. **The maximum allowed dB level for IMPBA Sanctioned events will be 92 dB.**
3. Measurements must be made from the shoreline area, between buoy #6 and the starting line. The measuring device will be set at a minimum height of 4' to 6' above the ground, with the device pointed approximately 90 degrees to the running path of the boats 25 feet back from the waters edge\*. Stable mounting such as a tripod is strongly recommended. Care should be taken to assure the operator of the measuring device is in a safe location.

4. If more than one measurement is made, the highest reading will be used. At the discretion of the CD, a participant may be required to make a solo run to determine a dB reading. If a participant refuses to make a solo run, they will be disqualified from the event.
5. Measurements will only be made on boats that are on the race course, and are well under way (i.e., not getting on plane or being launched or in the pits). The boat should be traveling approximately perpendicular to the direction the measuring device is pointed, and the boat should be located approximately in front of the measurement device in one of the racing lanes on the front straightaway.
6. Measurement of the noise level should ideally be performed by the CD, but he/she may be assisted by others appointed by the CD if this is not practical.
7. A competitor must be warned promptly after the CD determines that their boat exceeds the dB limit. If during the subsequent round the boat still exceeds the dB limit, the boat will be disqualified from competition. All points earned during the previous rounds will be valid.
8. The host club shall provide the measuring device.

### **III - HULL CLASSIFICATIONS**

- A. It is the intent of IMPBA to separate hulls into two (2) distinct classifications: Monoplanes (Mono), and Hydroplanes (Hydro). Both hull types are defined in detail below.
- B. Hulls can compete in only one hull class. No non-permanent modifications can be made to a hull to change its basic classification.
- C. The bow is the forward part of the boat's structure, not including any wings or air dams.
- D. All hulls shall have a maximum hull length of 60 inches, bow to stern, and a maximum gross weight of 30 pounds, including fuel (race ready).

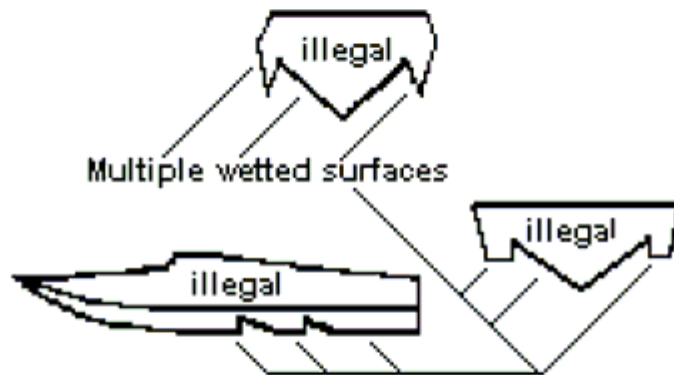
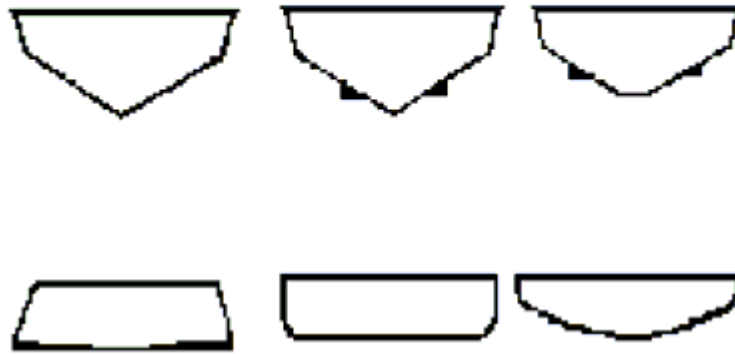
#### **1. Mono Hull Definitions and Restrictions**

“Mono” is a hull that has a continuous wetted surface when operating at racing speed. Mono must incorporate the following design characteristics and not exceed any of the dimensional restrictions.

- a. A hull that has no discontinuities between or steps in the wetted surface running at more than a 15-degree angle with keel, in plane view (bottom view).
- b. No point on a hull cross section shall be deeper in the water than the center keel (skid fins, trim tabs, and cavitation plates excepted).
- c. A lap straked hull is defined as a single wetted surface hull, with at least one strake on each side of keel. Any number of strakes may be used.
  - i. A strake is a strip of wood, metal, fiberglass or other material that is permanently attached to the hull bottom or used in an overlapping "weatherboard" hull construction.
  - ii. If strakes are used between mid-point of the hull length and transom, they must be parallel with the keel.
  - iii. Strakes terminating before the transom cannot have squared ends creating a step; they must be faired.
  - iv. Strakes must not be as low as keel.
  - v. Strakes shall be no more than 3/4 of an inch wide and 5/16 of an inch deep.
- d. Cathedral type hulls and other multiple wetted surface hulls are not legal in the Mono hull classes.
- e. Wings are illegal on a Mono.
- f. Examples: See Appendix 1 - Mono Hulls.

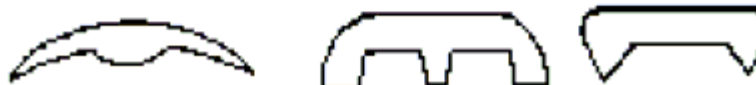
Appendix 1 – Mono Hulls

Hull examples for Monos - OK (with or without strakes)



Multiple wetted surfaces

Hydros - Tunnels



## 2. Hydro Hull Definitions and Restrictions

A Hydro is a hull that has several wetted surfaces when operating at racing speed. A Hydro can fall in any of the following classifications and for all of these the propeller(s) will not be considered a suspension point.

In addition, any hull with added appendage, with air lifting characteristics capable of lifting the hull free of water while maintaining stability, will also be classified as a HYDRO. Refer to individual class rules for specific Hydro restrictions.

- a. 3-Point Suspension Hull: Will have two individual steps separated by a continuous "hull". These steps shall terminate at or before "hull" midpoint. The hull must be continuous with no steps or extra planning surfaces aft of hull midpoint. Air trap devices shall be a maximum of .125" across the bottom surface for engine class B or larger with no restriction on depth. Airfoils, wings, air dams, ground effects devices, etc., shall have no limitation, considering no hydrodynamic support is gained from the device. See Nitro Special Classes, "Sportsman Hydro" for Additional Specialized class boat specifications.
- b. 4-Point Suspension Hull: A typical 4-point suspension hull will have a water planning surface at each corner of the hull or in each quadrant of the hull.
- c. Multi-Suspension Hull: A hull may have more than 4 suspension points that are water planning surfaces and the number and configuration may be limited only to the designer's imagination.
- d. Single Step Hulls: A typical single step hull will resemble a basic monoplane hull with a step usually ending forward to the hull's midpoint with the steps trailing edge running perpendicular to the hull's keel or length. The single step hull may also be considered as a two-point suspension hull.
- e. Multiple Step Hulls: This hull will conform to the single step hull definition with additional steps employed.
- f. Hydrofoil Suspension Hulls: Hydrofoil suspension hulls will have a hull which may be, but is not restricted to, a monoplane style that is lifted free of the water when operated at speed by skis or foils which are secured to the hull with struts.
- g. Tunnel Hulls: The tunnel hull will have two continuous keels or "sponsons", thus creating a tunnel or air trap along the length of the hull.
- h. Catamaran Hulls: Catamarans will be defined as "Tunnel Hulls" with extended free board that resemble full-sized offshore racing hulls.
- i. Cunard Hulls: Cunard will be defined as having two main rear sponsons and a single forward sponson.

### E. Official IMPBA Hull Classification Technical Committee. (See list of Officers Constitution)

The Executive Board will appoint the IMPBA Technical Committee. This committee will grant an Official IMPBA Hull Classification as follows:

1. Commercially manufactured hulls  
Classification cost: \$10.00 per hull

Manufacturers will supply, at their cost, either a detailed set of plans or a bare hull.

An official letter defining classification (Mono, Hydro or undefined) will be sent to the manufacturer. This letter will be the manufacturer's authorization to use the IMPBA classification in any advertising or other commercial purpose.

2. Individual Members Original Design Hulls

If an IMPBA member wishes to have a design officially classified, he may submit drawings or sketches to the Technical Committee. If the information is sufficient, the hull will be officially classified. A letter showing hull class will be returned to the individual member.

## **IV - PROTESTS**

The contestant, by entering a contest or Record Trial, automatically grants the right of inspection by Protest Procedure. Should a contestant refuse inspection, the Protest will be judged valid and penalties will be issued as outlined in "Protest Fees and Illegal Equipment Fines", this section.

### **A. If an engine or hull is protested during or after a contest, it will be handled as follows:**

#### **1. During a contest**

- a. The equipment will be allowed to run only until the Protest can be evaluated.
- b. The equipment will be immediately measured and reviewed by a Committee made up of the Contest Director, IMPBA District Director (if available), and two disinterested IMPBA members.
- c. All reviewing and measuring will be done in conjunction with the "IMPBA Engine Rules" as written. These rules are the law and the only grounds for Protest.
- d. Protestor and owner or proxy must be notified, and can be present during the review.
- e. If the Protest is upheld, and the equipment judged illegal, a written report outlining the infraction ruling must be forwarded to the District Director and President within two days of the Protest. Contest Director plus two Committee members must sign the report.
- f. If for some reason the Committee cannot make a ruling, a written report, complete with sketches, if necessary, will be forwarded to the IMPBA President who will distribute copies to the Technical Committee for final judgment.

#### **2. Protests After a Contest or Record Run**

If for some reason information becomes available after a contest or Record Trial that would have grounds for a Protest:

- a. The person or persons processing this information are duty bound to forward in writing all the details to their District Director and the President no later than 30 days after publication of that record in the quarterly report.
- b. The letter must contain the signature and IMPBA number of the writer.
- c. Copies will be forwarded to the Technical Committee and the owner concerned.
- d. The District Director will conduct an investigation and forward all findings to the Technical Committee.
- e. The ruling by the Technical Committee will be final.

### **B. Protest Fees and Illegal Equipment Fines**

1. The Protestor shall pay a \$5.00 Protest Fee.
2. If the Protest is denied, the fee will be retained by the host club to defray expenses.
3. If the Protest is upheld, and the equipment declared illegal, the Protestor will receive his Protest fee back.
4. Fines for running illegal engines and hulls:
  - a. Offenses are cumulative in a calendar year and are chargeable to the owner.
    - 1st offense \$25.00
    - 2nd offense \$50.00 and suspension from competition for 1 year
    - 3rd offense expulsion from organization
  - b. IMPBA General Office will record offenses and send a registered letter to the owner requesting payment of fine.
  - c. Fine must be paid within 20 days of notification.
  - d. Non-payment will result in cancellation of all IMPBA privileges for the succeeding twelve (12) months.

## V - IMPBA APPROVED COURSES

### General

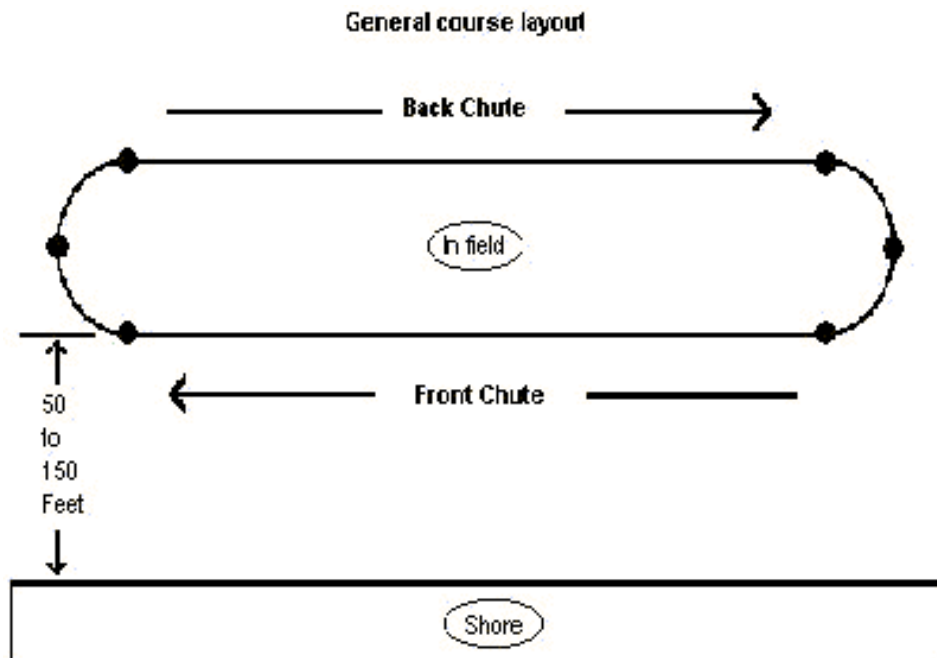
- A. The area between the turns shall be referred to as the front and back "straights" or "chutes" respectively.
- B. The section with the course marker buoys is referred to as "within the course" or as the "infield".
- C. The buoys at the far end of the chutes are referred to as the "Entrance Buoys" to the turns. The buoys at the head or start of the chutes are referred to as the "Exit Buoys" for the turns.
- D. For scoring and course reference purposes, all marker buoys shall be numbered consecutively in the direction of the course starting with the first buoy to the left of the Start/Finish buoy and ending with the buoy immediately to the right of the Start/Finish buoy.

The Start/Finish buoy shall carry no number identification.

Straightaway buoys will be added to the 1/3-mile oval course only. The front straightaway buoy will be located halfway between the start/finish line (center of course) and buoy one; the back straightaway buoy will be located halfway between the center of course and buoy four.

The optional Radius Buoys will be added to the 1/3-mile oval course only. The Radius buoys shall carry no number identification. The Radius buoys will be placed in between buoys 1&2, 2&3, 4&5, and 5&6.

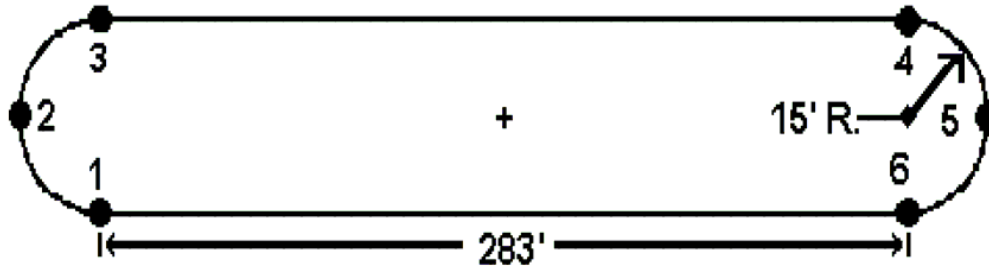
- E. For ease of driving, it is imperative that the course be laid out as nearly parallel to the shore being run from as possible.
  - 1. It is strongly recommended that the front chute (between buoys 1 & 6) be no closer than fifty (50) feet to shore for safety reasons.
  - 2. Under no circumstances can the front chute be more than one hundred and fifty (150) feet from shore.
- F. To establish IMPBA records, the course must be set up exactly as shown. Straightaway buoys are not required for records.





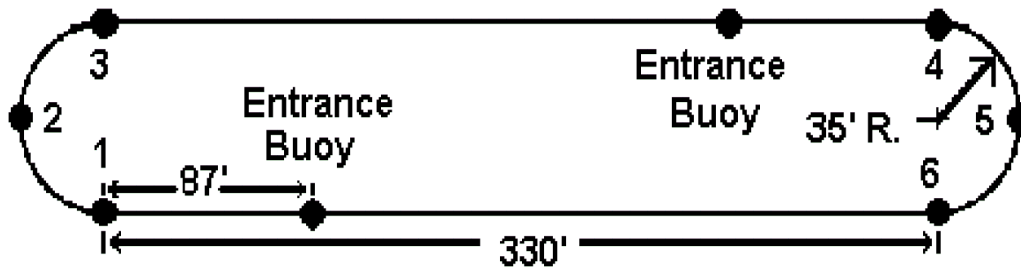
**1/4-Mile Oval Approved Course Layout**

- A. Total distance around 1/8 mile - 660 feet.
- B. Turn radius both ends - 15 feet.
- C. Straightaway (chute) length, front and back - 282.87 feet



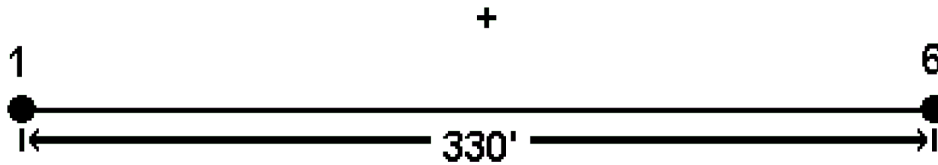
**1/3-Mile Oval Approved Course Layout**

- A. Total distance around 1/6 mile - 880 feet.
- B. Turn radius both ends - 35 feet.
- C. (chute) length, front and back - 330.05 feet



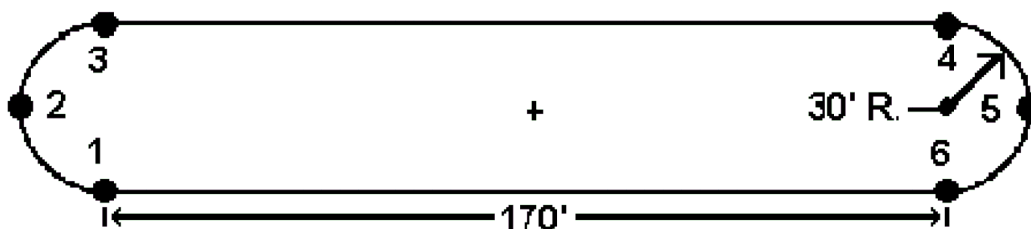
**1/16-Mile Approved Straightaway Layout**

- A. Straightaway length 1/16 mile - 330 feet
- B. The 1/16 and 1/3 mile oval, straightaway may be used interchangeable as the difference is only 0.05 feet or six tenths (0.6) of an inch.



**1/5-Mile Oval Electric Approved Course Layout**

- A. Total distance around 1/10 mile - 528.5 feet.
- B. Turn radius both ends - 30 feet.
- C. Straightaway (chute) length, front and back - 170 feet



## **VI - SETTING UP IMPBA APPROVED COURSES**

The purpose of this section is to establish precise methods of setting up IMPBA approved courses and the documentation required to be filed with IMPBA prior to issuance of any record trial sanctions.

### **A. Base Reference Points**

Points A&B (Base Points) and C & D (Target Points) must be set in concrete to assure accuracy and permanence. The following procedure to establish points will be used:

1. Point A is established approximately 25 feet in from shore at the left end of the proposed course. This point is then set in concrete. It is suggested that a 2 to 2-½ inch pipe with a union to be set in the concrete to be used later for locating buoy positions.
2. A transit is then located and leveled directly over Point A and aimed toward Point B on a line parallel with the front straightaway you intend to establish. A survey chain or 100 foot steel tape is then used to measure out 330 feet, 220 feet or 170 feet for the course required. The transit must be used to assure that each move of the tape is dead on line.
3. With the required distance measured off, Point B is established and set in concrete including the pipe and union.
4. Rotate transit exactly 90 degrees counterclockwise. This will establish line A-C. Set a pipe and union in concrete for point C.
5. Move transit so it is leveled directly over Point B. Sight back to Point A using a section of pipe screwed into union at point A to sight on. Rotate transit clockwise 90 degrees and establish Point D. Set a pipe and union in concrete for point D. See Figure 1.

### **B. Buoy Locators**

Buoy locators must be set to dimensions shown in "Approved Courses Layouts" for the 1/4, 1/3 and 1/5 mile oval courses, and must be permanent in nature so the course may be checked at any time. See figures 3, 4 & 5 for buoy anchoring methods. Three methods of locating buoy positions are permitted and all must establish the course within the dimensional tolerances given in "Course Dimensional Tolerances", this section.

1. Using full trigonometric survey procedures.
2. In shallow to medium depth ponds, buoys may be located using a steel surveyor's tape and sighting with a transit on lines A-C and B-D. This will locate buoys 1, 3, 4 and 6. The course should be laid out parallel to shore. Buoys 2 and 5 will be located by using two steel tapes, one on an entrance buoy location done at an exit buoy location and intersecting at equal distances as follows:
  - 1/3rd Oval 49.50 feet or 49 feet 6 inches
  - 1/4th Oval 21.21 feet or 21 feet 2 1/2 inches
  - 1/5th Oval 42.43 feet or 42 feet 5 inches
3. A cable or rope may be marked for buoy locations and stretched taut between points A & C, then B & D, and used to established buoy locations. Aircraft cable or polypropylene ski rope is preferred to minimize stretching, as this will tend to make the course longer. See Figure 2.
4. In colder climates where ponds freeze over, buoy locations may be laid out on the ice and holes cut through the ice to establish the course points.

### C. Three Methods of Buoy Anchoring

Three methods of buoy anchoring are permitted, with the "hard to pond bottom" method preferred. Should any buoy position be lost or moved prior to, or during, a record trial event, it is the responsibility of the contest officials to properly re-establish this buoy position in order to maintain the validity of the IMPBA sanction and any IMPBA World Records which may be set.

#### 1. Hard to Pond Bottom Method

Pipes driver, in or auger ends screwed hard into the pond bottom are required. This is the preferred method of buoy anchoring in shallow to medium depth ponds. See Figure 3.

#### 2. Spaced Frame Method

This method is similar to the "weighted buoy method" except a spaced frame is used to locate buoys 2 & 5. The frame may be made of any light, rigid material such as aluminum tubing, PVC pipe, etc. Anchors must be of sufficient weight to prevent frame movement if a buoy is struck. This is the preferred method of buoy anchoring for deeper ponds and lakes. See Figure 4.

#### 3. Weighted Buoy Method

This method may also be used in deeper ponds; however, accurately measuring distances for locating buoys 2 & 5 may be difficult. Anchors must be of sufficient weight to prevent buoy movement if struck, and a written description or drawing of these anchors and their weights is required. It is suggested that anchors weighing 50 lb. or more be used. See Figure 5.

### D. Course Dimensional Tolerances - (1/3, 1/4, 1/5)

Length Dimensions

330, 220, 170 foot + 2 feet - 6 inches

Radial Dimensions

35 foot & 30 foot radius + 1 foot - 3 inches

15 foot radius + 1 foot - 0 inches

Any course found to exceed those tolerances would be considered illegal. Future sanctions will be revoked and recent records set at the course reviewed.

### E. Documentation

1. A licensed commercial surveyor or graduate civil engineer must witness and approve all dimensional requirements of the 1/16 straight or oval course installation. A statement indicating the method used and approved must be signed including a seal or stamp from the commercial surveyor or signature, college or university, and year degree was received by the graduate civil engineer.
2. A map or layout of the pond or lake showing course location, base and target points, and method used for buoy location and anchoring must be furnished.
3. If the site requires the use of sensor transmitter stands, or mounts, as described below, a written description or drawing of these mounts shall be provided.
4. Sanctions will not be issued for record trials unless the above documentation accompanies sanction applications or has been previously filed with IMPBA.

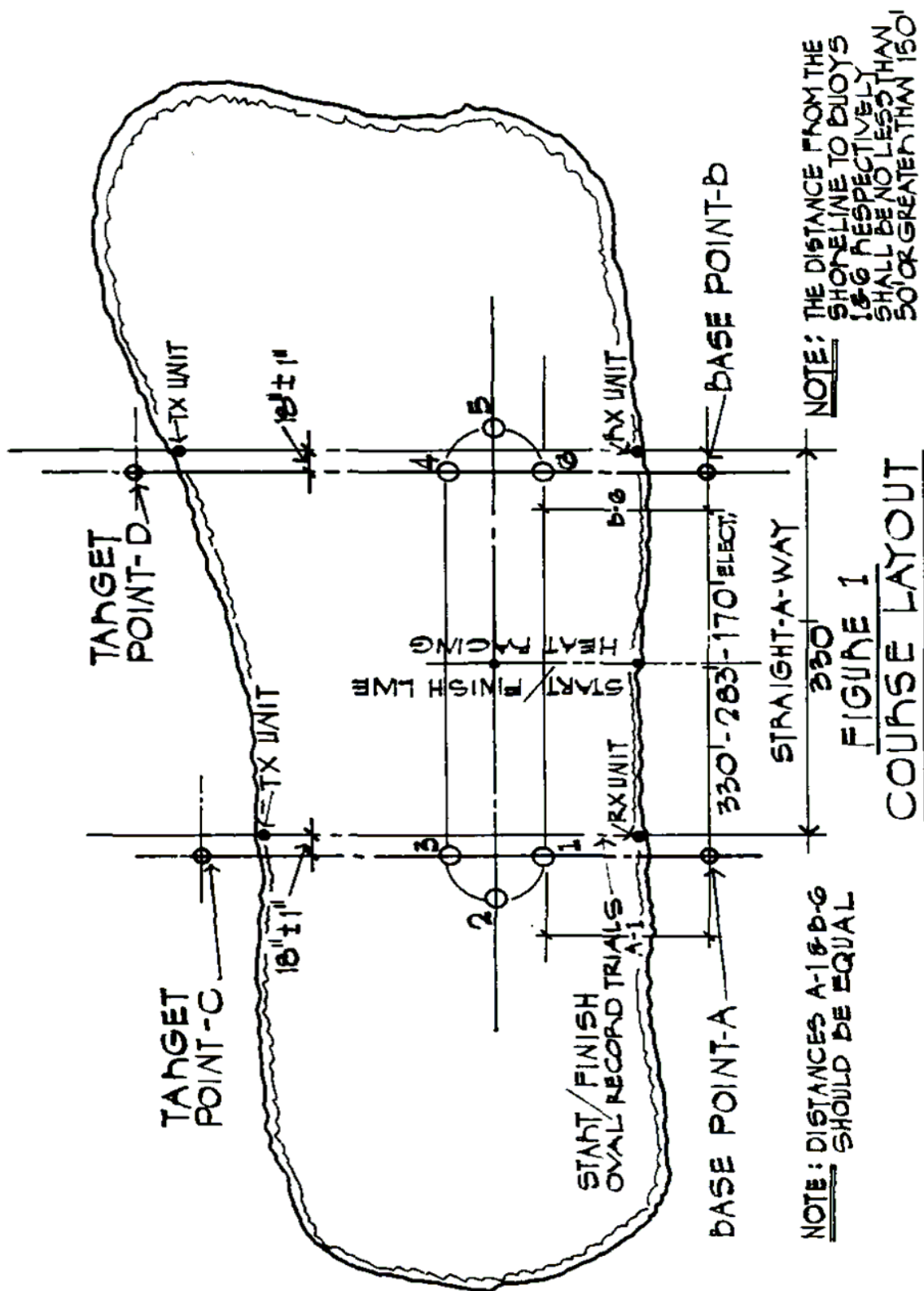
#### **F. Sensor Location**

To establish mounting points for the IMPBA Electronic Timing Equipment, the infrared beams must be offset parallel to the buoy lines A-C and B-D. The sensors shall be placed so that the beams are offset 18 inches +/- 1 inch to the right of the buoy lines. See Figure 1. To establish the offset distance, a line may be stretched between points A & C and B & D, or a transit used to sight between the points, then the offset distance may be measured at 90 degrees to the buoy line. It is the responsibility of the contest officials to ensure that the electronic sensors are properly located in relation to the surveyed course. Any deviation in their location will void the record trial sanctioned any IMPBA World Records which may have been set.

#### **G. Timing Equipment**

Timing equipment must be IMPBA approved electronic timing equipment.

The electronic timing equipment supplied by IMPBA is furnished with mounting brackets to fit tubing or rod with a maximum diameter of 1-3/8 inches. One-inch 'schedule 40' black or galvanized water pipe is readily available and fits the brackets perfectly. This pipe should be driven deep enough into the ground to provide a steady platform for the equipment (2 – 3 feet is ideal), leaving approximately 18 to 24 inches above the water level. See Sensor Location section above for proper sensor locating. The practical maximum range of the infrared beams is approximately 600 feet, with a manufacturer's theoretical maximum range of 900 feet. For wider ponds and lakes, the transmitting units (far side) must be mounted in the middle of the lake on stands or permanent mounts and aligned. See Figure 6.

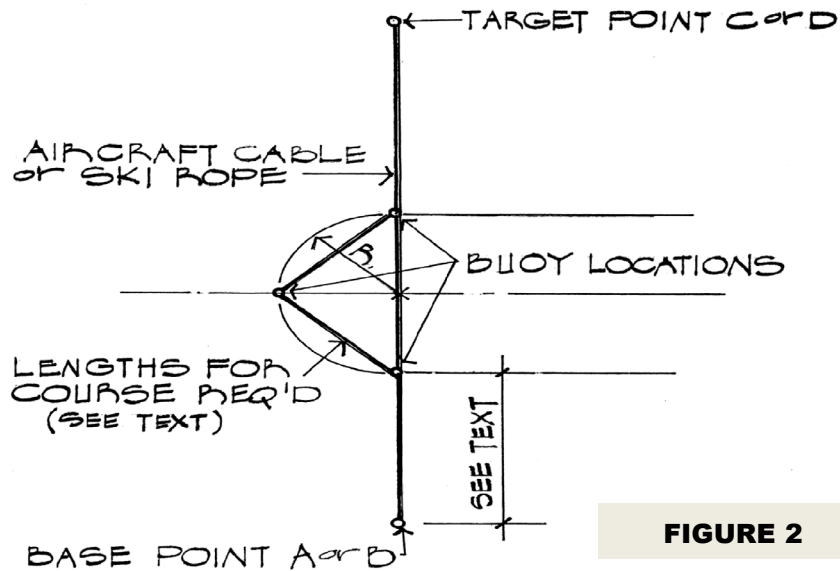


NOTE: THE DISTANCE FROM THE SHORLINE TO BUOYS 1&6 RESPECTIVELY SHALL BE NO LESS THAN 50' OR GREATER THAN 150'

NOTE: DISTANCES A-1&B-G SHOULD BE EQUAL

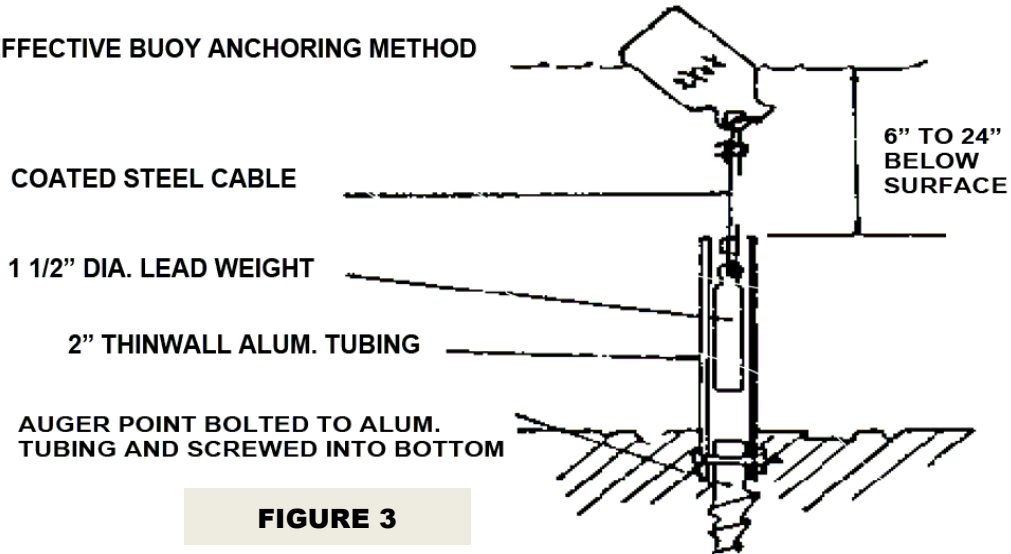
STRAIGHT-A-WAY 330' - 263 - 170' ELECT

FIGURE 1  
COURSE LAYOUT

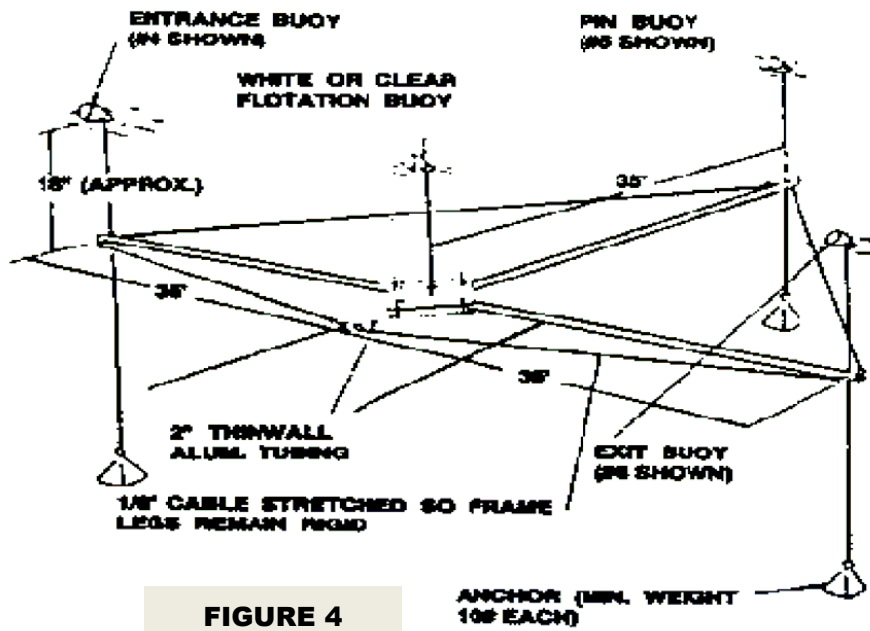


**FIGURE 2**

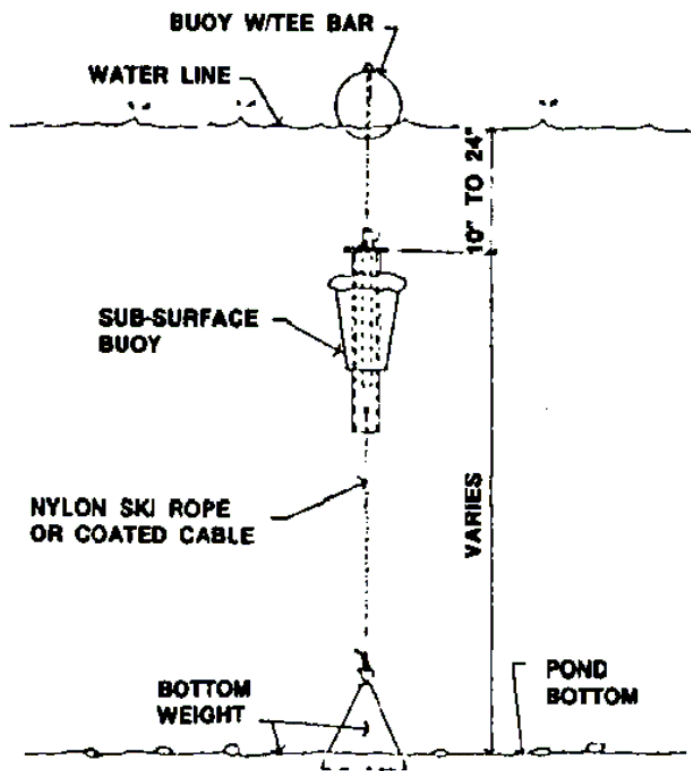
**EFFECTIVE BUOY ANCHORING METHOD**



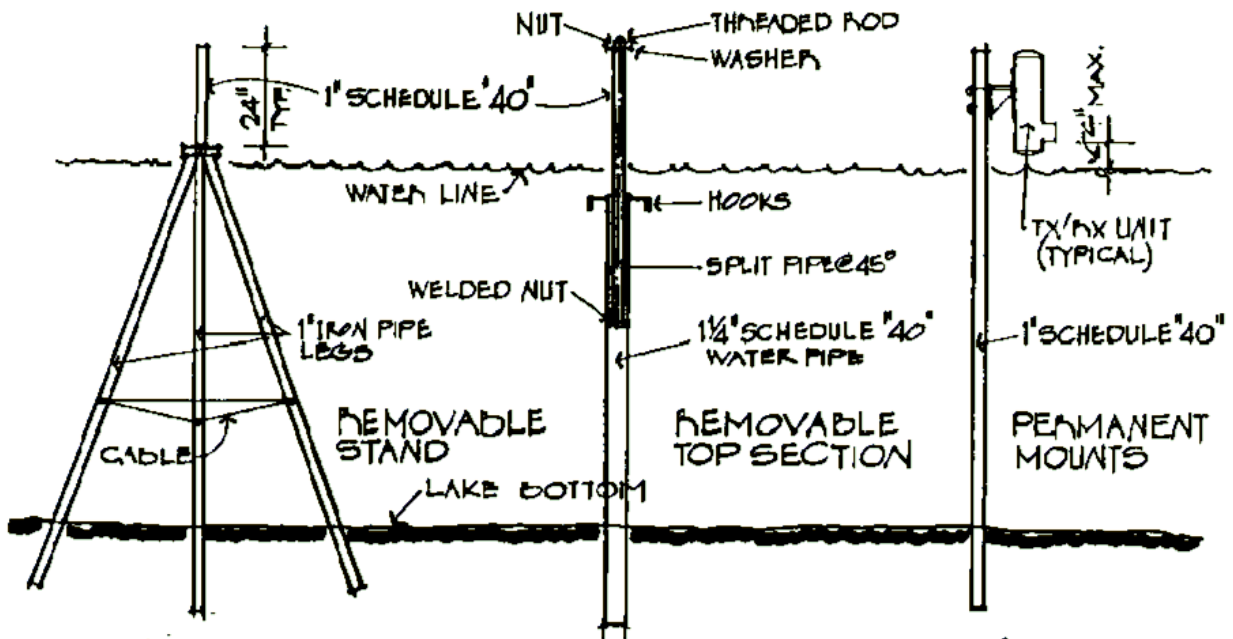
**FIGURE 3**



**FIGURE 4**



**FIGURE 5**



**FIGURE 6**  
**TRANSMITTER MOUNTS**

## VII - RACE STARTING CLOCK OPERATIONS

### A. General Specifications

The following specifications are applicable to all new clocks built after January 1, 1976 and clocks used at the International Regatta and other major events after that date. It is not mandatory to change existing clocks prior to January 1, 1979, except for the following two mandatory requirements:

#### 1. Locations

All clocks must be in the water inside the course at approximate center of straightaway. Floatation must be styrofoam blocks. Note: In-water location not required for 1/4-mile oval course with 15-foot radius Turns.

#### 2. Second Hand (Circular Clocks)

Must swing continuously in 30 second plus or minus 1-second revolutions from start of pit time to start of race.

### B. Circular Clocks (see Appendix IV, this section)

The following specifications have been developed with the driver's interest in mind. He must drive by the hand position, as this is his only form of reference. Therefore, any other indications of official start must coincide precisely with hand position. Any variations between top dead center hand position and indication of start by a strobe or continuous light will not be permitted.

#### 1. Accuracy

Plus or minus 1 second per revolution

Maximum variation of second hand from 1st half of rotation (down) and second half of rotation (up) 1 second.

#### 2. Diameter of Clock Face

32" to 40"

#### 3. Colors

Face Color - White or Day Glow Orange

Hand(s) Color - Black

Face Markings - Black

#### 4. Type of Operation

a. **Option 1 - Two Hands:** one 30 sec. Sweep & one 3 Minute Sweep. In using this option, clock face must have the following identification points:

- i. 30-Sec. Sweep Hand, 15-Sec., 7.5-Sec., & 5,4,3,2, and 1-Sec.
- ii. 3 Min. Sweep - 2 Min., 1 Min. and 30 Sec.
- iii. 5 Sec. segment to be identified by a contrasting color pie section.

b. **Option 2 - One Hand and Light(s)**

- i. 1 Hand, 30 Second Sweep. Face must have the following identification points: 15 Second, 7.5 Second, and 5, 4, 3, 2, 1 Second. Five second segment to be identified by contrasting color pie section.
- ii. Lights - 5 Red indicating 5-30 Sec. Intervals from 3 Min. down to 30 Sec. All 5 to be on at start of pit time. One light shuts off with each revolution of 30 seconds (no launch) period before start of race. Strobe or continuous light may indicate start. See sketch- Option 1.

c. **Option 3 - A combination of 2 hand Clock & Lights** indicating 30 second (no launch) period & start. Face markings and light colors to correspond to Options 1 and 2.



5. **Time span - 3 Minutes or 2 1/2 Minutes**

To prevent driver confusion only the 3 minute or 2 1/2 minute clock was approved for 1980. If desired, clock may continue running after start of race to denote maximum 5- minute period to prevent delays.

6. **Official Start Device**

Official start is indicated by the top dead center of 30-second hand. It is strongly recommended that a strobe light triggered by a micro switch type device adjusted to coincide precisely with Top Dead Center (TDC), be incorporated in all clocks whether they be of 1 or 2 hand design. This allows the starting judge to focus on the boats instead of trying to focus on both the boats and the hands of the clock. The flash of a strobe is far more effective than turning on a continuous light.

**C. Digital Clock**

Digital clock designs will have numerical digits as valid indicators of time remaining before the start of the event. Digital Clocks certified by IMPBA after January 1, 2005, which include the Timed Event option will be considered official for use in all IMPBA Timed Events including the yearly Regatta. These Digital clocks must have an attached IMPBA certification plate. These clocks or components thereof will be re-certified at the direction of IMPBA Technical Review, and sent/returned from the official certification personnel at the owner's expense.

1. **Specifications**

a. **Accuracy**

Plus or minus 1 second from start of pit time to start of race.

b. **Time Indicator**

Three numerical digits arranged horizontally, left digit to indicate full minutes, center and right digit to indicate portion of minutes remaining. Digits will appear, as a number comprised of seven segments with four vertical segments and three horizontal segments. Each digit's arrangement will emulate the number 8 when fully activated. Segments will be electronically activated to appear and represent the numbers one through zero.

c. **Physical Requirements**

Each seven segment digit will have height from 8 inches to 24 inches and its width will be two-thirds the height. Overall enclosure dimensions will be sized to accommodate the digit section. Front face will have a high contrast ratio to the seven segment digits. A colon will be placed between the left most and center digit to identify the display as counting in minutes (colon is on), or the display counting in seconds (colon is off). The enclosure bottom will locate above the water line by six to eighteen inches.

d. **Colors**

Enclosure face will be black. Enclosure remains will be white. Digit segments will be high contrast white or Day Glow colors when activated, and will appear black when inactive. Optional: Digits could be comprised of rows of lights.

e. **Type of Operation**

Digits will count down in one-second increments until display is blank. All Leading zeros will be suppressed to aid in ease of reading time remaining. Example:

When clock counts down from 1:00 (1 minute) to 59 seconds the display will show:

1:00

59 Note that the leading zeros and the colon are suppressed.

As the countdown continues from ten seconds to nine seconds the display will show:

10

9

As time expires from 1 second to zero the display will show:

1

"blank" or optional start of the 5:00 minutes of race time and continue counting.

**Optional:**

The clock may produce an audio "beep" from the 5-second time remaining to expiration of time being displayed. The clock may also be used to count down the 5 minutes of race time. Accuracy of the 5 minute "Race Time" will be plus or minus 1 second from start to the expiration of run time.

f. **Time Span**

Initial count time will depend on type of race being run. This will be three minutes or 2-1/2 minutes for Nitro/Gas events, 60 seconds for Fast Electric Oval, and 5 seconds for Fast Electric Enduro. This clock using the 2 1/2 minutes as Pit Time and the 5 minutes as Run Time may time other timed events such as Time Trials.

g. **Official Start Device**

Official race start is indicated by a "blank" display or by switching to the 5:00 minutes of race time and the triggering of a strobe light. Optional additions, the clock may produce audio wobbling sound, trigger a horn, or vocalize with the words "Race-Race-Race".

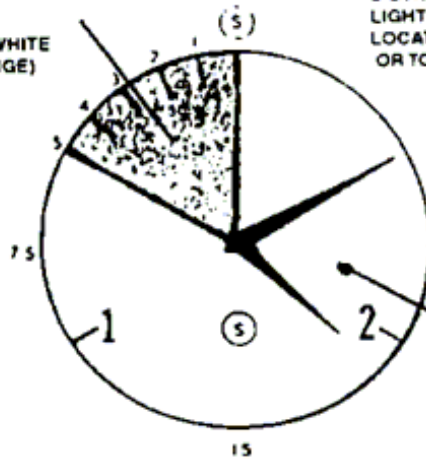
2. **Other Optional Uses**

The clock may be used to display the Heat Number that is to be run. This heat number display will only appear after the completion of a timed event. The clock may be used as an official timekeeper for Record/Trophy Trials timing (for 5 minute clock) only after the timing equipment has been tested, certified, and approved by the Technical Committee and IMPBA Board of Directors.

# APPENDIX IV

5 SECOND START AND 30 SECOND (NO LAUNCH) SEGMENT  
 COLOR-OPPOSITE OF FACE COLOR (WHITE OR DAY GLO ORANGE)

S STROBE OR START LIGHT OPTIONAL  
 LOCATION IN FACE OR TOP DEAD CENTER



**TWO HAND CLOCK**

COLOR FACE-  
 WHITE OR DAY GLO ORANGE  
 HANDS AND FACE  
 MARKINGS BLACK

5 SECOND START AND 30 SECOND (NO LAUNCH) SEGMENT  
 COLOR-OPPOSITE OF FACE COLOR (WHITE OR DAY GLO ORANGE)

R-RED LIGHTS 930 SEC. EACH)

A- AMBER LIGHTS OPTIONAL  
 LOCATION FACE OR AFTER LAST RED

COUNT DOWN



S-STROBE OR START LIGHT, OPTIONAL  
 LOCATION IN FACE OR TOP DEAD CENTER

NOTE: RED LIGHTS MAY BE ACROSS  
 TOP OR DOWN RIGHT HAND SIDE

**LIGHTS AND SINGLE  
 HAND CLOCK**

COLOR FACE-  
 WHITE OR DAY GLO ORANGE  
 HANDS AND FACE  
 MARKINGS BLACK

**DIGITAL CLOCK**

EACH 7-SEGMENT DIGIT WILL  
 HAVE A HEIGHT FROM  
 8 TO 24 INCHES  
 ITS WIDTH WILL BE 2/3 THE HEIGHT



ENCLOSURE FACE WILL BE BLACK.  
 ENCLOSURE REMAINS WILL BE WHITE.  
 DIGIT SEGMENTS WILL BE  
 CONTRAST WHITE OR DAY GLO COLORS  
 WHEN ACTIVATED, AND WILL APPEAR  
 BLACK WHEN INACTIVE.

DIGITS WILL COUNT DOWN IN  
 ONE SECOND INCREMENTS UNTIL  
 DISPLAY IS BLANK.