

# AMCO ALUMINUM DIE-CAST MERCURY REFLECTOR

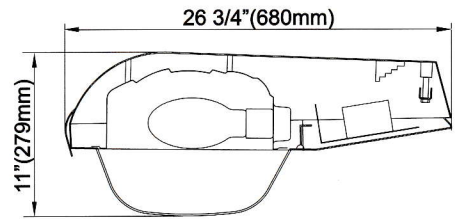

MERCURY BULB

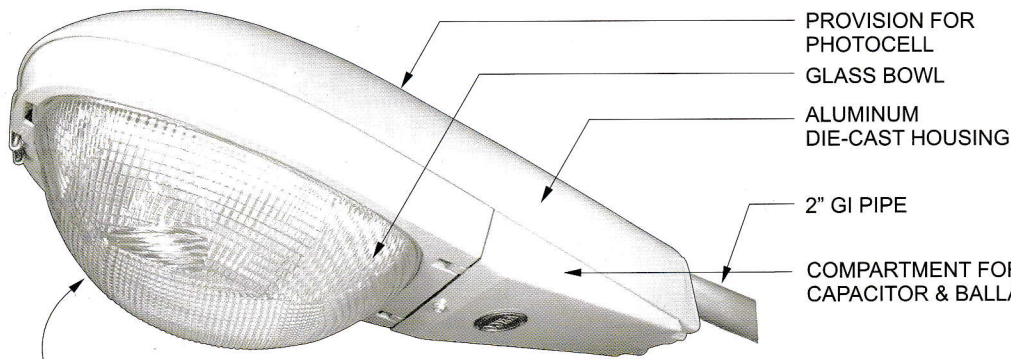
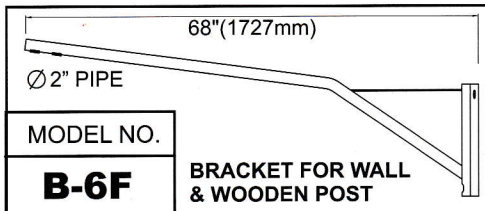

MODEL NO.	ACCOMMODATE
<b>D7-AL</b>	Max. 250W - w/ Ballast Max. 250W - w/o Ballast

MODEL NO.	BRACKET FOR WALL & WOODEN POST
<b>B-6F</b>	

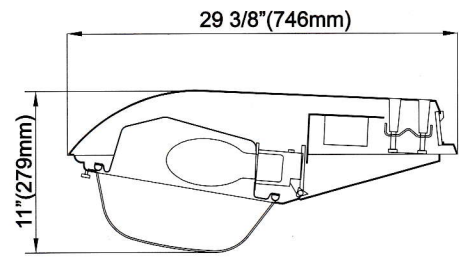
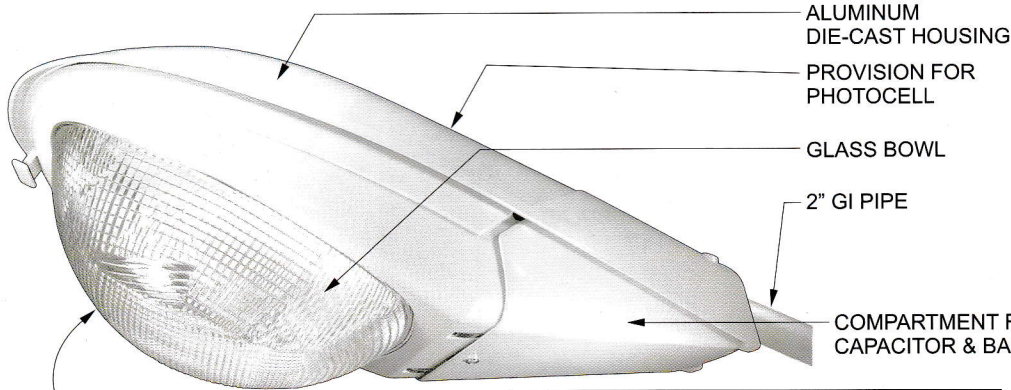
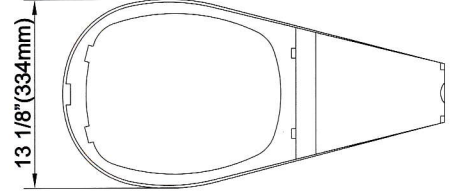

MERCURY, METAL HALIDE  
OR SODIUM BULB

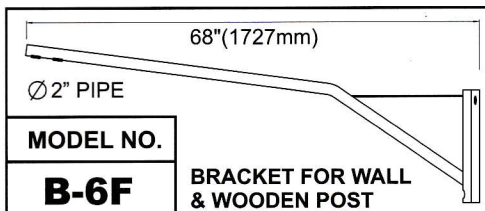

MODEL NO.	ACCOMMODATE
<b>D7-BL</b>	Max. 400W - w/ Ballast Max. 500W - w/o Ballast

MODEL NO.	BRACKET FOR WALL & WOODEN POST
<b>B-6F</b>	

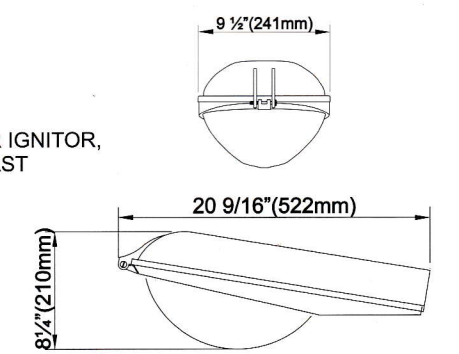
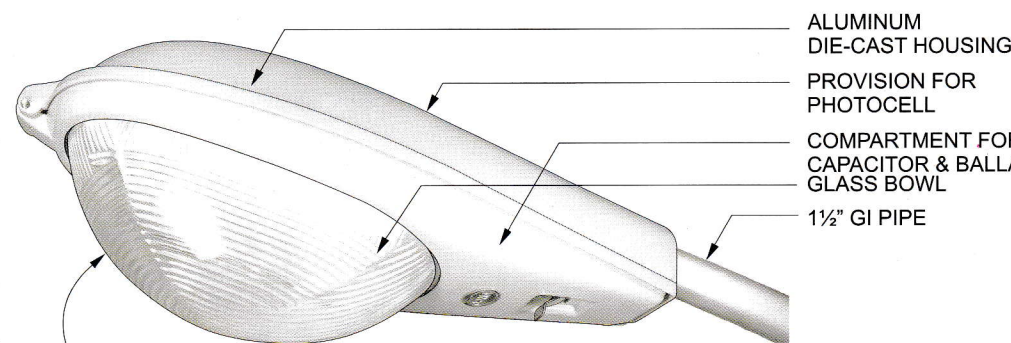
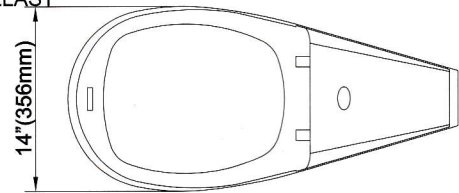

MERCURY, METAL HALIDE  
OR SODIUM BULB

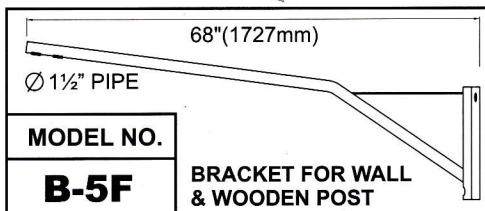

MODEL NO.	ACCOMMODATE
<b>D3-AL</b>	Max. 125W - w/ Ballast Max. 250W - w/o Ballast

MODEL NO.	BRACKET FOR WALL & WOODEN POST
<b>B-5F</b>	

