

Swing to Archery

for the Fun of it!

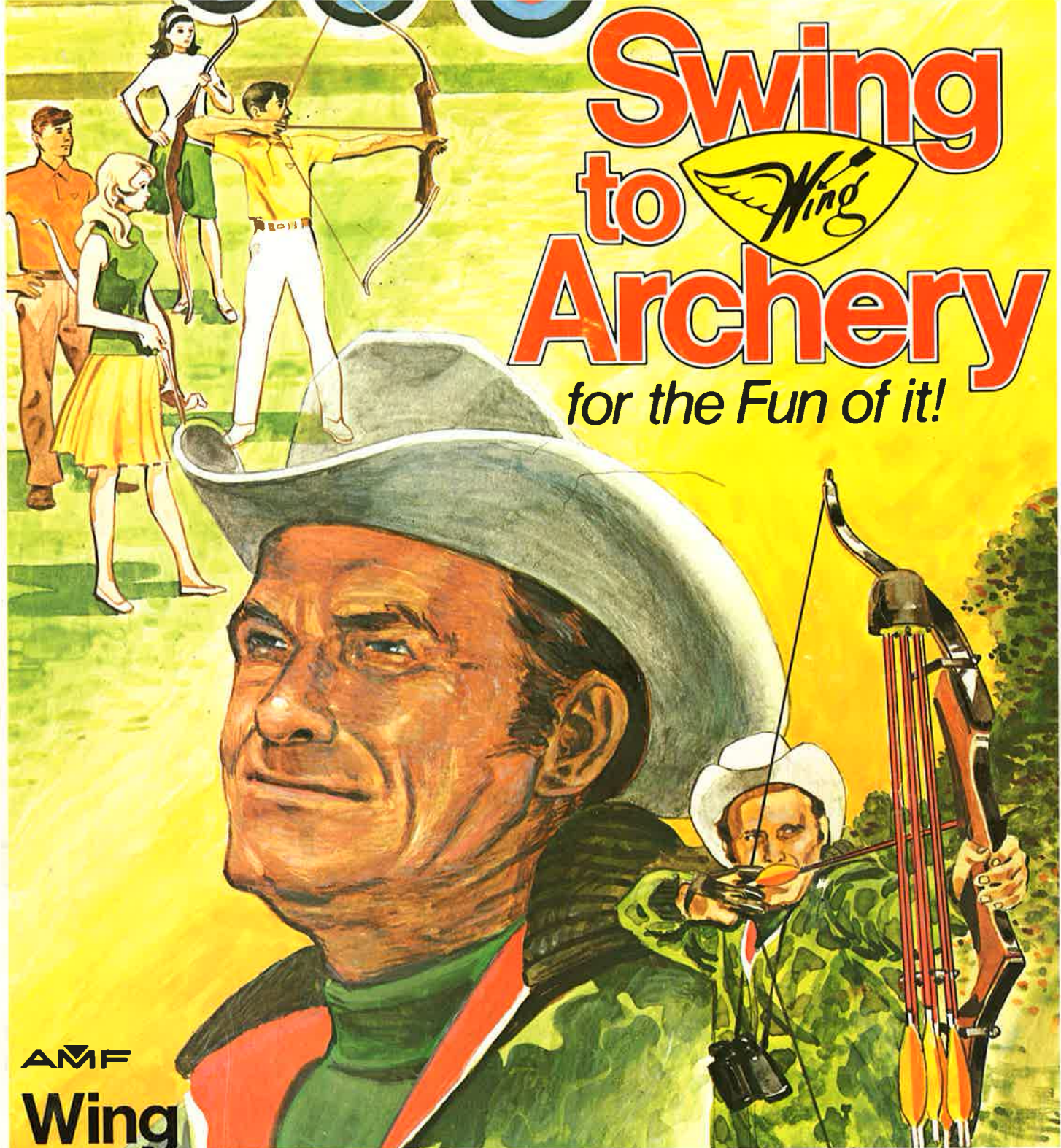

AMF

Wing

**Archery Equipment
1974**

INDEX: Page

Armguards	19
Arrow-making Materials and Tools	16-17
Arrow Nocks	17
Arrow Rests	21
Arrows	
Aluminum	8-9
Fiberglass	8-9
"Switch-A-Point"	8-9
Wood	8-9
Books, Instructional	24
Bow Cases	18
Bowfishing	20
Bow Quiver	14
Bow Sights	22-23
Bow Square	21
Bow Stringer	21
Bowstrings	21
Bowstring Wax	21
Bows	
Hunting	4-5
Target	2-3
Utility	6-7
Compound	12-13
Brush Buttons	15
Buck Lure	15
Camouflage Items	15
Cements	17
Clickers	21
Cushion Plunger	21
Dealer Aids	23
Films	24
Gloves	19
Hunting Accessories	15
Hunting Points	15
Kisser Button	21
Leather Goods	18-19
Nocking Points	21
Peepsight	22
Quiver	14, 18
Sets (Packaged)	6-7, 14
Shirts, Wing Official	23
Shirt and Blouse Protector	19
Sling	19
Stabilizers	13, 22
String Server	21
String Silencers	15
Tabs	19
Target Faces	24
Tip Protectors	21



A MESSAGE FROM BOB LEE

Archery has probably fascinated men longer than any other sport, and it continues to grow in popularity—for the fun of it! Whether you are a beginner, a serious amateur, a target-shooting champion, or an experienced bow hunter, archery—the oldest sport—is always new. And Wing Archery always has the equipment you need.

For 22 years Wing has been making fine archery equipment, building a reputation of excellence on the design of our equipment, the precision of our manufacturing techniques, and the uncompromising rigidity of our quality-control procedures.

This year I am pleased to welcome two champions to Wing: John Williams, 1972 Olympic Gold Medalist, is our new Chief Advisor, specializing in target-shooting equipment. You will find John's signature on some of our new and re-designed bows for 1974, and in others you will discover improvements inspired by the expertise of this young champion. And 1970 National Field Archery Champion Frank Ketchum has made design improvements in the compound bow* and will supervise its manufacture for Wing. The *Wing Compound Bow by Ketchum* is offered for the first time in this catalogue.

All of us at Wing Archery are excited by the innovations that you will find in our equipment for 1974. We think you will be, too, when you see and handle Wing equipment at your sporting goods store.

Good shooting!

Bob Lee

President
AMF WING ARCHERY DIVISION

Bob Lee

Denton Hill

"98"

Charlotte Lee
'98

*Licensed under Allen pat. #3486495.

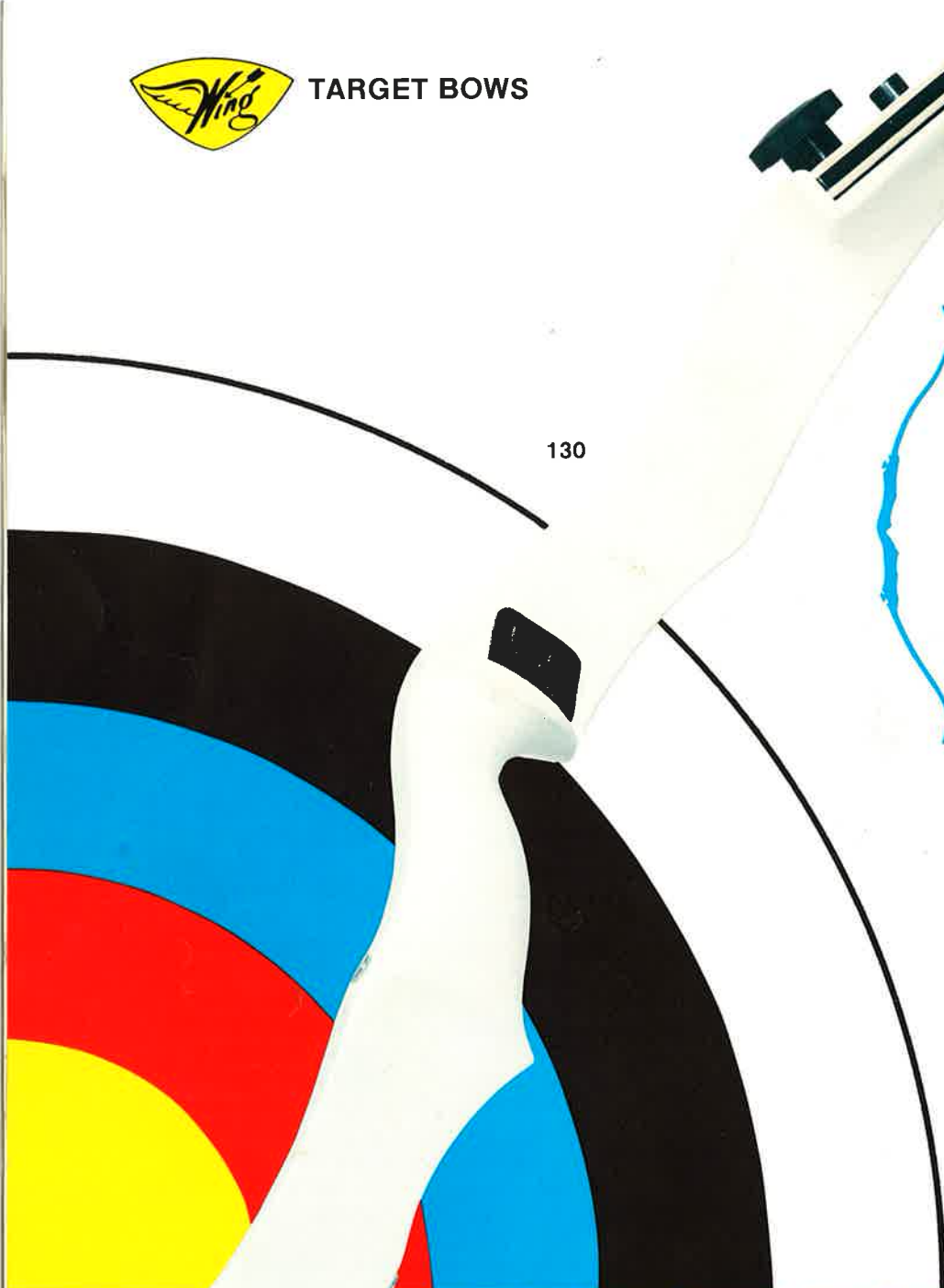

130

JOHN WILLIAMS TAKEDOWN BOW

New, exciting takedown bow designed by Olympic Champion John Williams.

Wing officials have felt the need for a bow with the takedown features of the most expensive professional models but at a lower cost for archery enthusiasts who want moderately priced equipment. Now with John Williams' help, Wing offers this signature bow which has most of the features of the top-line models.

Available in target and hunting models. Lightweight magnesium handle.

The target model comes in 66" and 70" lengths with ivory, black or blue handle and ivory limbs. The hunting model comes in 62" and 66" lengths with black handle and limbs.

STANDARD EQUIPMENT on the target model includes sight adapter, three stabilizer inserts and hole for cushion plunger. For the hunting model, the sight adapter and bow-quiver inserts are standard.

OPTIONAL EQUIPMENT for the target model includes Wing stabilizer (p.22), sight extension (p.22), cushion plunger (p.21) and bow stringer (p.21). For the hunting model, optional items include Wing hunting stabilizer (p.22), hunting sight (p.22), bow quiver (p.14), quick-attach fishing reel (p.20) and bow stringer (p.21).

AMO Lengths: Target, 66", 70".
Hunting, 62", 66".

Weights: Target, 25 to 50 lb.
Hunting, stocked in 40, 45, 50 and 55 lb.

Riser: Magnesium. Target model available in ivory, blue and black.

Hunting model in black only.
Glass color: Ivory. Weights of 45 lb. and over are black.

Physical Weight:
Approximately 2 lb., 12 oz. (target)
Approximately 2 lb., 10 oz. (hunting)

Catalog order: **130** Target.

- 131** Hunting.
- 132** Handle only. Specify length. Target or Hunting.
- 133** Limbs. Specify length.

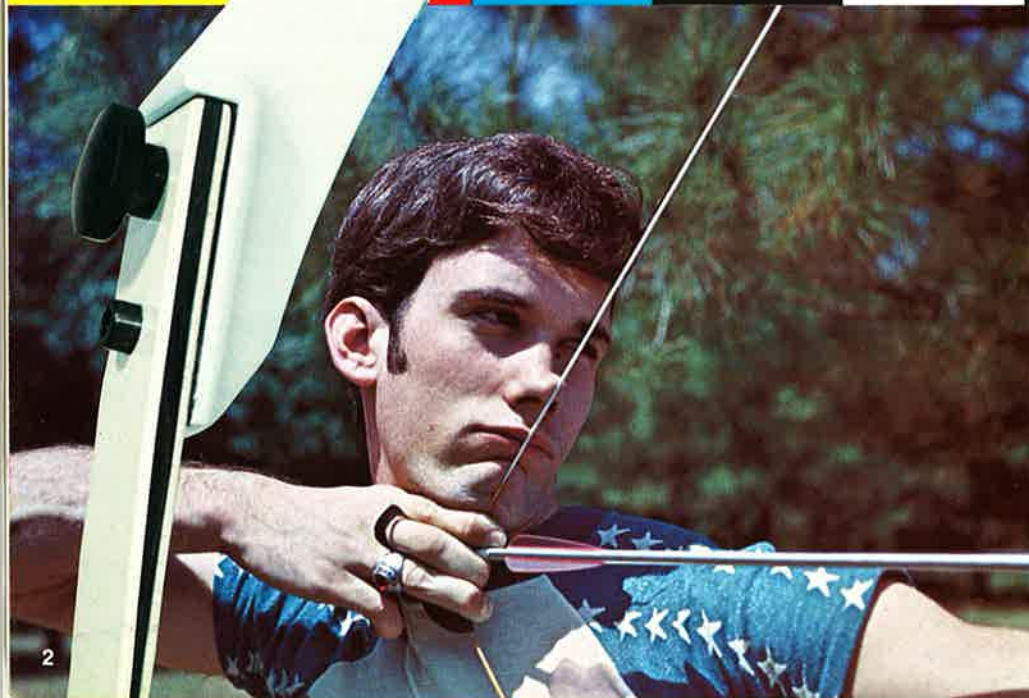

PRESENTATION II

Wing's standard-bearer, the Presentation II, doesn't act like a standard bow. The ultimate achievement in bow-making, Wing's Presentation II looks, feels and performs like no other bow made.

The Presentation II features Wing's exclusive limb-coupling system that allows quick and easy changing of limbs. Three sets of limbs are available in a variety of draw weights for maximum versatility.

Presentation II versatility really comes home when the seasons change! When target season is over, just replace the target limbs with your choice of hunting limbs, and you have the same familiar bow geared for a different kind of trophy—and back again when it's tournament time!

Five stabilizer positions and a built-in stabilizer insert are provided for exact mass and stability adjustments. A sight window cut well past center allows plenty of adjustment for any size arrow. The grip is designed to discourage torquing and thus greatly improve consistency and accuracy.

STANDARD EQUIPMENT includes padded vinyl case (specify long or short), stabilizer insert, Wing flip rest, professional bowstring with monofilament serving.

OPTIONAL EQUIPMENT: Wing stabilizer (p.22), sight extension (p.22), cushion plunger (p.21), bow quiver (p.14), quick-attach fishing reel (p.20), bow stringer (p.21).

AMO Lengths: 62", 68", 70".
Weights: 68" and 70", 25 to 50-lb.
62" stocked in 40, 45, 50 & 55-lb.
(Allow additional delivery time for 35, 60 & 65-lb.)

Riser: WINGWOOD in attractive black and rose with decorative ebony and pearl cap.

Glass Color: 62", black; 68" & 70", white.
Catalog Order: **115** (complete)
116 (handle only)
117 (limbs only, pair)

SWIFT WING

A fine target bow, an excellent bow for hunting, a ladies' tournament bow: Swift Wing is also economically priced. The riser of high-density WINGWOOD makes Swift Wing an exceptionally handsome bow as well. Heavily influenced by the design of Presentation II, Swift Wing has features usually found only on more expensive bows. Swift Wing meets all standards of excellence—for hunting, for target, for tournament!

STANDARD EQUIPMENT includes built-in stabilizer insert, Wing flip rest, custom bowstring.

OPTIONAL EQUIPMENT: Padded vinyl case (p.18), Wing stabilizer (p.22), sight extension (p.22), cushion plunger (p.21), professional bowstring (p.21), bow stringer (p.21).

AMO Length: 66".
Weights: 25 to 40 lb. at 28" draw length.

Also available in hunting weights: 45, 50, 55 lb.

Riser: WINGWOOD.
Glass Color: White.
Catalog Order: **119**



115

119

All specifications in this catalog are in accordance with standards of the Archery Manufacturers Organization.



HUNTING BOWS



PRESENTATION II HUNTER

For consistency, speed and accuracy. Presentation II Hunter is one of bowhunting's most admired trophy-winners!

The mass of the high-density WINGWOOD riser contributes to accuracy and consistency. The AMO 62" hunting limbs are interchangeable with 68" and 70" limbs, and the exclusive positive limb coupling gives Presentation II the ultimate in convenience—quick conversion from a superb hunting bow to a fine target model. Coupled with the smoothness of advanced limb design, this feature gives the Presentation II maximum speed and maximum versatility.

With the limbs removed, transportation to the field is easier than ever. For hunting or target, the Presentation II sets a standard that is hard to match!

STANDARD EQUIPMENT includes such extras as a padded vinyl bow case (specify long or short), stabilizer insert, and bow quiver adapter screws.

OPTIONAL EQUIPMENT: Wing stabilizer (p.22) sight extension (p.22), cushion plunger (p.21), hunting sight (p.22), bow quiver (p.14), quick-attach fishing reel (p.20), bow stringer (p.21).

AMO Length: 62".
Weights: Stocked in 40, 45, 50, & 55-lb.
Allow additional delivery time for 35, 60 & 65-lb.
Riser: WINGWOOD in attractive black and rose with decorative ebony and pearl cap.
Glass Color: Black.
Catalog Order: **115** (complete)
116 (handle only)
117 (limbs only, pair)

THUNDERBIRD

The smooth-drawing limb design that made the first THUNDERBIRD famous is back by popular demand. And with its distinctive riser of exclusive high-density WINGWOOD with plenty of mass for accuracy, Thunderbird is rugged, masculine—a real bowhunter's bow.

Smooth draw, maximum cast, beautiful riser: a real combination for hunters. Available in AMO 54" length for compactness in tight areas, or AMO 62" for the extra stability of a longer bow.

STANDARD EQUIPMENT includes inserts to accommodate the hunting stabilizer, ultralight Wing bow quiver and quick-attach fishing reel.

OPTIONAL EQUIPMENT: Wing bow quiver (p.14), hunting sight (p.22), quick-attach fishing reel (p.20), bow stringer (p.21), hunting stabilizer (p.22).

AMO Lengths: 54", 62".
Weights: Stocked in 40, 45, 50, 55-lb.
Allow additional delivery time for 35, 60, 65, & 70-lb.
Riser: Black WINGWOOD.
Glass Color: Black.
Catalog Order: **120** (62") **121** (54")

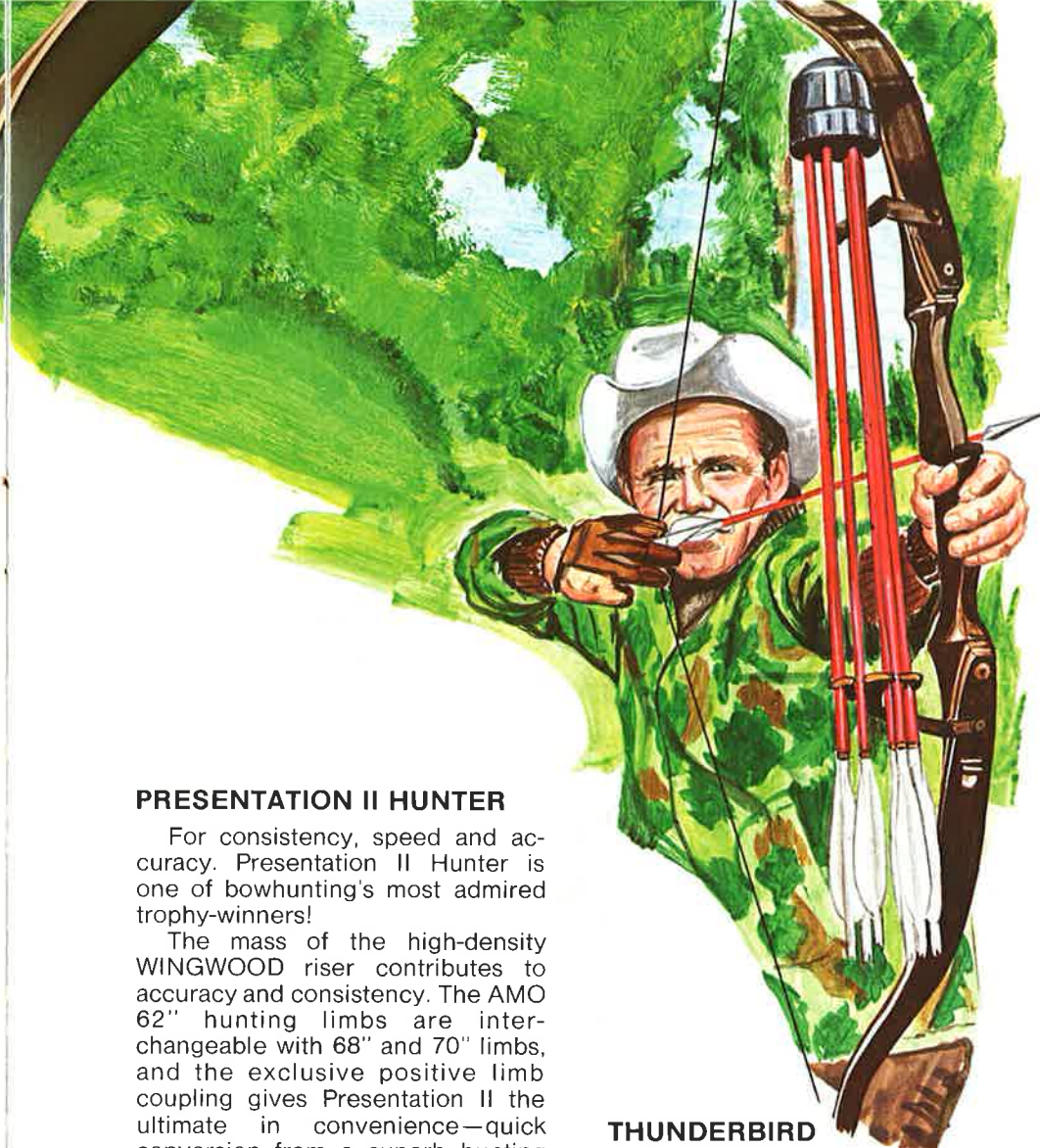

RED WING HUNTER

Honest. Basic. Red Wing Hunter. Consistently the game-hunter's choice! Hunting standard bearer of the archery industry.

Since its introduction the Red Wing Hunter has been respected and acclaimed for its consistent performance. It has strength, accuracy and stability. And it is available in two lengths to suit any hunter's needs. Both travel compactly and easily.

STANDARD EQUIPMENT includes inserts for the Wing bow quiver, hunting stabilizer, and quick-attach fishing reel.

OPTIONAL EQUIPMENT: Wing bow quiver (p.14), hunting sight (p.22), quick-attach fishing reel (p.20), bow stringer (p.21), hunting stabilizer (p.22).

AMO Lengths: 52", 58".
Weights: Stocked in 40, 45, 50, 55-lb.
Allow additional delivery time for 35, 60, 65, & 70-lb.
Riser: WINGWOOD.
Glass Color: Natural brown.
Catalog Order: **122** (58")
123 (52")

HAWK

The newest hunting bow from Wing. Hawk is a great performer in the field, with the versatility that Wing hunting bows are famous for. Strong, accurate and stable, Hawk has the simplicity and the reliability that the unencumbered bowhunter needs. And Hawk is the ideal bow for the first-time hunter.

STANDARD EQUIPMENT includes inserts to accommodate the ultralight Wing bow quiver, hunting stabilizer, and quick-attach fishing reel.

OPTIONAL EQUIPMENT: Wing bow quiver (p.14), hunting sight (p.22), quick-attach fishing reel (p.20), bow stringer (p.21), hunting stabilizer (p.22).

AMO Length: 58".
Weights: 35, 40, 45, 50-lb.
Riser: Exotic hardwoods.
Glass Color: Brown.
Catalog Order: **112** (Bow only)
128 (Set. See p. 14)



UTILITY BOWS



100

124

125

126

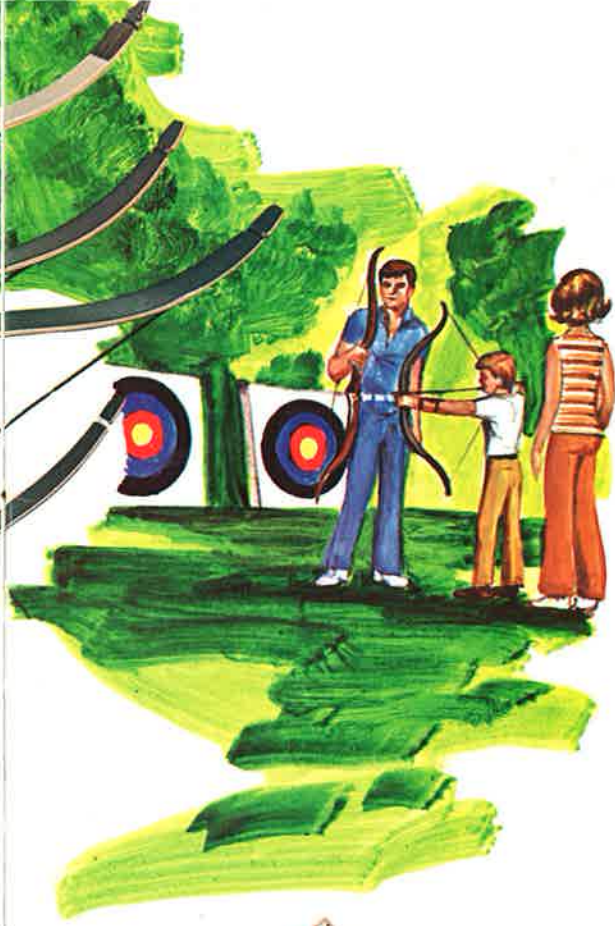

FALCON

Beautiful! Dependable! Falcon has design features usually found only in more expensive bows. Full working recurves, a form-fitting handle, wide overdraw and full center sight window make Falcon much more than just a beginner's bow. The riser of exotic hardwood combines strength with beauty in a bow that brings real excitement to archery.

And now Wing introduces Falcon-66, the ideal low-priced range and tournament bow in AMO 66" length! Built-in stabilizer insert is standard equipment on Falcon-66 only.

AMO Lengths: 62" & 66".
Weights: (62") 20, 25, 30, 35, 40-lb. at 28" draw length (66"). 20, 25, 30, 35, 40-lb.
Riser: Exotic hardwood.
Glass Colors: Assorted.
Catalog Order: 100 (66") 124 (62")

NIGHTHAWK

Olympic Champion John Williams has redesigned the Nighthawk Bow with increased recurve, a more custom-fitting handle. The new Williams Signature Nighthawk is

ideal for beginners—on the range or at school. Helps develop technique easily and gradually, as it should be.

AMO Length: 60".
Weights: 15, 20, 25, 30, 35-lb. at 28" draw length.
Riser: Maple.
Glass Colors: Assorted.
Catalog Order: 125

LITTLE WING

The beginning bow for the archer who doesn't want to look like a beginner. Little Wing is *the* bow for the youngster who is just starting. With its tropical hardwood riser, glass-and-maple laminated limbs, contoured handle, center-shot sight window, and performance that won't quit, Little Wing looks just like Mom's and Dad's bows, and performs like them for the youngster. Little Wing is the way to build an archer!

AMO Length: 48"
Weight: 20-lb. at 24" draw length.
Draw Limit: 28"
Riser: Tropical hardwood.
Glass Colors: Assorted.
Catalog Order: 126



YOUTH SETS

JOHN WILLIAMS YOUTH SET

Perfect for the beginner! Includes a 50", 18-lb. recurved glass bow, four cedar target arrows, shooting tab, armguard with matching belt quiver, John Williams Instruction Chart, instruction booklet, target face.

Minimum dealer pack: 3 sets/box.
Catalog Order: 901

JOHN WILLIAMS EXPLORER SET

Designed for the teenager and the young adult. Perfect for Scouting. Includes a 56", 25-lb. recurved glass bow, six 26" target arrows, shooting tab and armguard, belt quiver, John Williams Instruction Chart, instruction booklet, four-color target.

Minimum dealer pack: 3 sets/box.
Catalog Order: 902

BOB LEE BOWHUNTER SET

Starts the beginning bowhunter right! Includes a 56", 45-lb. recurved glass bow, four matched hunting arrows, shooting tab and armguard, bow quiver, John Williams Instruction Chart, instruction booklet, four-color target.

Minimum dealer pack: 3 sets/box.
Catalog Order: 903

JOHN WILLIAMS BEGINNER SET

The complete instructional set for the young beginning archer who wants the very best. Features the Little Wing Bow, six 26" target arrows, shooting tab and armguard, belt quiver, John Williams Instruction Chart, instruction booklet, four-color target.

Minimum dealer pack: 3 sets/box.
Catalog Order: 127

WING YOUTH BOW

Solid glass recurved bow; 50", 18-lb.
Packed 6/carton.
Catalog Order: 904

WING EXPLORER BOW

A John Williams Signature Bow, solid glass, recurved; 56", 25-lb.
Packed 4/carton.
Catalog Order: 905

WING HUNTER BOW

Solid glass recurved bow; 56", 45-lb.
Packed 4/carton.
Catalog Order: 906

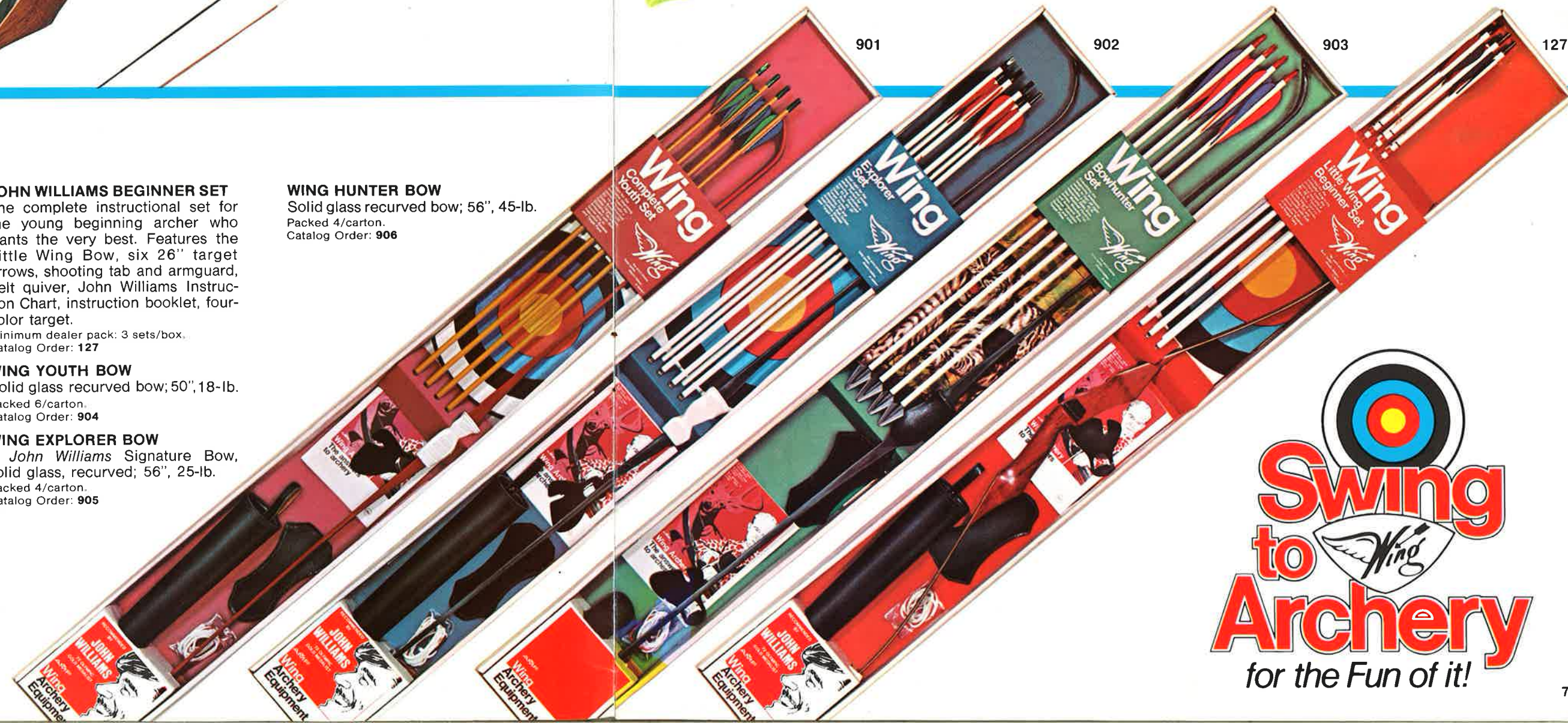

901

902

903

127

Swing
to
Archery
for the Fun of it!



ARROWS: SHAFTS AND POINTS

Precisely matched and uniform, Wing arrows are straight on target every time. That's why—from bowhunting to top target shooting—you can depend on Wing Arrows to make their mark.

Wing manufactures three kinds of arrows: aluminum, fiberglass, and wood. In aluminum Wing offers its popular Red Wing Arrow and Wing Aluminum Target Arrows. Both feature Easton shafting for professional-grade aluminum arrows.

Two grades of fiberglass arrows, Wing Custom Glass and Wing Glass, give the archer a choice of price ranges for a tough, straight shaft that is unaffected by normal temperatures and moisture.

Wing's Port Orford cedar arrows are manufactured from the finest cedar stock available. They offer economy in carefully spine- and weight-matched wood arrows.

All Wing aluminum arrows have Bjorn nocks as standard equipment. All Wing arrows are measured in accordance with AMO Standards.

WING ALUMINUM TARGET ARROWS

203/204. 24SRT. Sizes 1516, 1616, 1716, 1816, 1916, 1718, 1818.

203. Full-length, points unattached. **Specify bow weight.**

204. Cut to length & target points installed. **Specify bow weight and draw length.**

RED WING ALUMINUM HUNTING ARROWS

Dull red anodizing eliminates glare. Sizes 1916, 1918, 2016, 2018, 2020, 2219. **Specify bow weight and draw length.**

205/206. Full-length, broadhead adapters included but unattached. **205.** Crested. **206.** Uncrested.

207/208. Cut to length, broadhead adapters installed. **207.** Crested. **208.** Uncrested.

209/210. Cut to length, field points installed. **209.** Crested. **210.** Uncrested.

211/212. Cut to length, single-blade razorheads installed. **211.** Crested. **212.** Uncrested.

213/214. Cut to length, 3-blade high-precision hunting points installed. **213.** Crested. **214.** Uncrested.

215/216. Cut to length, 4-blade razorheads installed. **215.** Crested. **216.** Uncrested.

217/218. Cut to length, six 4-blade razorheads and six field points installed. **217.** Crested. **218.** Uncrested.

WING CUSTOM GLASS and WING GLASS ARROWS

Wing Glass and Custom Glass Arrows are made of the same fine fiberglass shafting. Custom Glass Arrows feature attractive dip and multicolored crestring, plus full 5" helical fletching. Wing Glass Arrows have full 5" fletching without dip or crestring.

WING CUSTOM GLASS and GLASS TARGET ARROWS

Sizes A through K (equivalent to 1-11) Weights: 20-70 lb. **Specify bow weight and draw length.**

220/221. Full-length, target points included but unattached. **220.** Crested. **221.** Uncrested.

224/225. Cut to length, target points installed. **224.** Crested. **225.** Uncrested.

WING CUSTOM GLASS and GLASS HUNTING ARROWS

Sizes F through K (equivalent to 6-11), Weights: 40-70 lb. **Specify bow weight and draw length.**

222/223. Full-length, broadhead adapters included but unattached. **222.** Crested. **223.** Uncrested.

226/227. Cut to length, broadhead adapters installed. **226.** Crested. **227.** Uncrested.

228/229. Cut to length, field points installed. **228.** Crested. **229.** Uncrested.

230/231. Cut to length, single-blade razorheads installed. **230.** Crested. **231.** Uncrested.

232/233. Cut to length, 3-blade high-precision broadheads installed. **232.** Crested. **233.** Uncrested.

234/235. Cut to length, 4-blade razorheads installed. **234.** Crested. **235.** Uncrested.

236/237. Cut to length, six 4-blade razorheads and six field points installed. **236.** Crested. **237.** Uncrested.

WING HAWK ARROWS

Top-quality wood arrows with fully-painted shaft and standard two-color crest. Full 5" helical fletching. Spine-matched to within 5 lb. **Specify bow weight and draw length.**

240. Full-length, no points. Available in 35 to 70-lb. weights in 5-lb. increments.

241. Cut to length, target points installed. Available in 26" through 30" lengths, 30 to 50-lb. weights in 5-lb. increments.



WING HAWK HUNTING ARROWS

Available in 28", 29", 30" and 31" lengths, 35 to 70-lb. weights in 5-lb. increments. **Specify bow weight and draw length.**

242. Cut to length, field points installed.

243. Cut to length, single-blade razorheads installed.

244. Cut to length, 3-blade high-precision broadheads installed.

245. Cut to length, 4-blade razorheads installed.

246. Cut to length, six 4-blade razorheads and six field points installed.

WING OWL ARROWS

Economical arrows suitable for beginners and experienced archers. Diagonal 5" fletching, full painted shafts, attractive crestring. Spine-matched to within 10 lb. Available in dozens and half-gross display cartons.

247. Full-length, no points. Available in 30 to 60-lb. weights in 10-lb. increments. **Specify bow weight.**

248. Cut to length, target points installed. Available in 26" to 30" lengths, 30 to 60-lb. weights in 10-lb. increments. **Specify bow weight and draw length.**

WING OWL HUNTING ARROWS

Available in 28", 29", 30" lengths, 30 to 60-lb. weights in 10-lb. increments. **Specify bow weight and draw length.**

249. Cut to length, field points installed.

250. Cut to length, single-blade razorheads installed.

251. Cut to length, 3-blade high-precision broadheads installed.

252. Cut to length, 4-blade razorheads installed.

253. Cut to length, six 4-blade razorheads & six field points installed.

254. WING FLU-FLU. In 29" length only. 125-grain blunt points installed. 35 to 70-lb. weights in 5-lb. increments. Packaged 4/box. **Specify bow weight.**

255. WING RAVEN. In 26" and 28" lengths only, target points installed. SUITABLE ONLY FOR BOWS UNDER 40 LB. Packaged in half-gross boxes. **Specify draw lengths** (e.g., all 26", all 28", or half 26" and half 28").

WING "SWITCH-A-POINT" ARROWS

Now one arrow can do the work of three! You can switch-a-point simply by unscrewing the point on the arrow and replacing it with another. It's done with aluminum inserts in Wing Red Wing Aluminum and Glass Arrows. Now you don't have to own a lot of extra arrows—just a handful of points! Wing "Switch-A-Point" Arrows are the most versatile, economical way to buy arrows!

RED WING ALUMINUM "SWITCH-A-POINT" ARROWS

Your best value in aluminum hunting arrows, featuring Easton 24SRT shafting, dull red anodizing to eliminate glare, and helical fletching. Sizes 1916, 1918, 2016, 2018, 2020, 2219. **Specify bow weight and draw length.**

260/261. Full-length, "Switch-A-Point" inserts included.

260. Crested. **261.** Uncrested.

262/263. Cut to length, "Switch-A-Point" inserts installed. No points. **262.** Crested. **263.** Uncrested.

276/277. Cut to length, "Switch-A-Point" broadhead adapters installed. No points. **276.** Crested. **277.** Uncrested.

264/265. Cut to length, "Switch-A-Point" 125-grain field points installed. **264.** Crested. **265.** Uncrested.

266/267. Cut to length, "Switch-A-Point" 125-grain blunt points installed. **266.** Crested. **267.** Uncrested.

268/269. Cut to length, "Switch-A-Point" single-blade razorheads installed. **268.** Crested. **269.** Uncrested.

270/271. Cut to length, "Switch-A-Point" 3-blade high-precision broadheads installed. **270.** Crested. **271.** Uncrested.

272/273. Cut to length, "Switch-A-Point" 4-blade razorheads installed. **272.** Crested. **273.** Uncrested.

274/275. Cut to length, six "Switch-A-Point" 4-blade razorheads & six "Switch-A-Point" 125-grain field points installed. **274.** Crested. **275.** Uncrested.

WING CUSTOM GLASS and GLASS "SWITCH-A-POINT" ARROWS

The versatility of Wing's "Switch-A-Point" system gives you the superior performance of Wing Custom Glass Arrows and the economy of Wing Glass Arrows with interchangeable points. Both Wing Custom Glass and Wing Glass Arrows are available in "Switch-A-Point" sizes F through K, and in weights from 40 to 75 lb. Wing Custom Glass Arrows are dipped and crested. Wing Glass Arrows are not. **Specify bow weight and draw length.**

280/281. Full-length, "Switch-A-Point" inserts included but not installed. No points. **280.** Crested. **281.** Uncrested.

282/283. Cut to length, "Switch-A-Point" inserts installed. No points. **282.** Crested. **283.** Uncrested.

296/297. Cut to length, "Switch-A-Point" broadhead adapters installed. No points. **296.** Crested. **297.** Uncrested.

284/285. Cut to length, "Switch-A-Point" 125-grain field points installed. **284.** Crested. **285.** Uncrested.

286/287. Cut to length, "Switch-A-Point" 125-grain blunt points installed. **286.** Crested. **287.** Uncrested.

288/289. Cut to length, "Switch-A-Point" single-blade razorheads installed. **288.** Crested. **289.** Uncrested.

290/291. Cut to length, "Switch-A-Point" 3-blade high-precision broadheads installed. **290.** Crested. **291.** Uncrested.

292/293. Cut to length, "Switch-A-Point" 4-blade razorheads installed. **292.** Crested. **293.** Uncrested.

294/295. Cut to length, six "Switch-A-Point" 4-blade razorheads and six "Switch-A-Point" 125-grain field points installed. **294.** Crested. **295.** Uncrested.



John Williams ... the champion swings to Wing

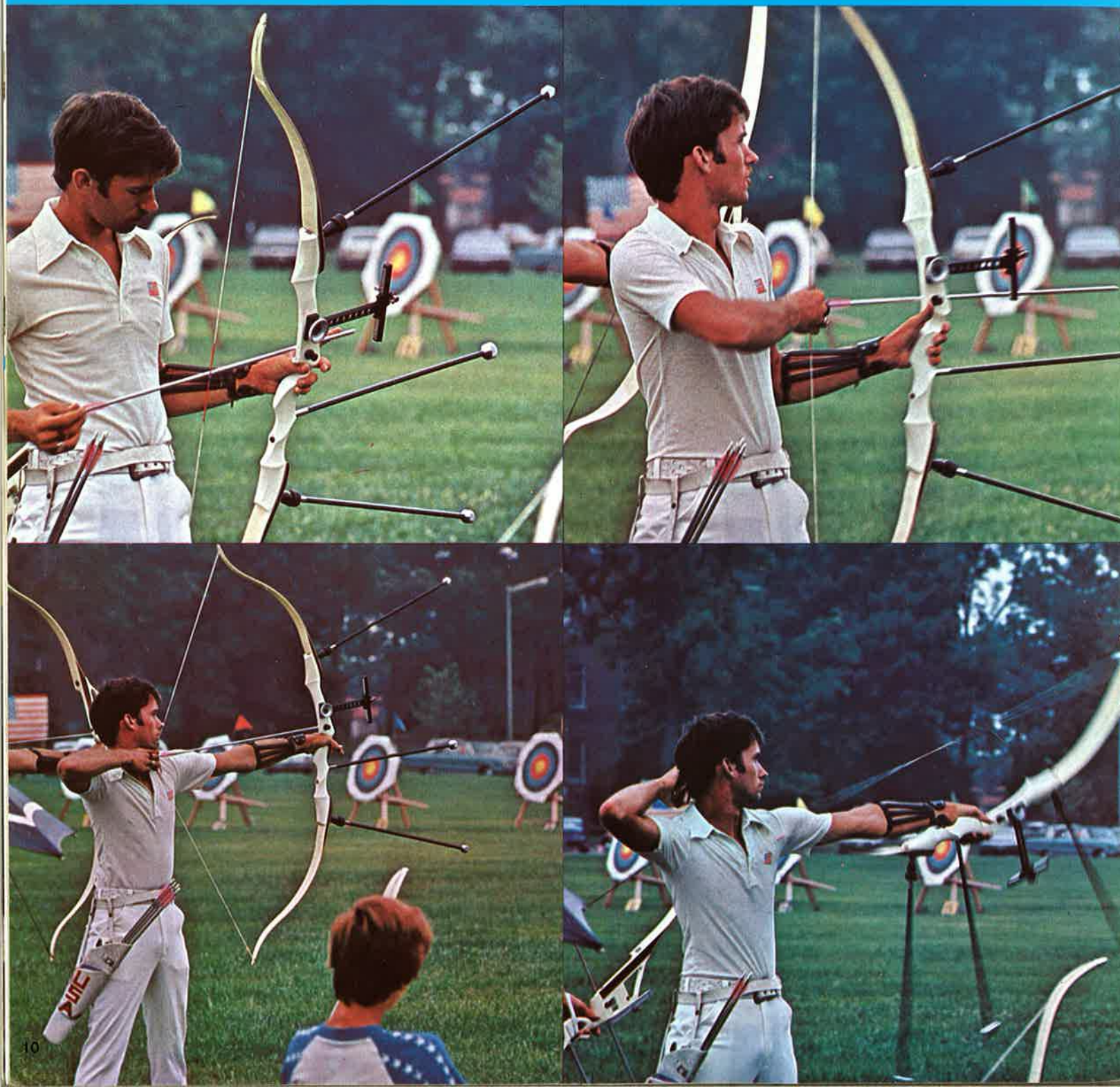

Archery is a sport that everybody can enjoy. And every archer can enjoy it more with equipment and training that fine-tune him to perform at his very best. Wing's 1974 line of archery equipment includes just the right equipment—and in my opinion, the *best* equipment—for every archer.

As Chief Advisor, I will have a hand in the design of Wing's top-line competition equipment, of course. I am proud of adding the John Williams Takedown Bow to this year's Wing line. I think you will agree with me that it's a great bow for your archery needs. Because archery has meant so much to me, I want to see it grow; and for that reason I will be devoting a lot of my time and energy to the design of equipment and the training of young archers. That is why you will find my signature on the new Wing Nighthawk and Explorer Bows in this catalog. That is why every Wing Set for young archers now includes my own illustrated instructions for the development of the style and habits of shooting that helped me win at Munich.

Not everybody can be an Olympic Champion. Not everybody wants to. But with Wing Archery equipment every archer can realize the ultimate of his own ability and desires. *Every* archer can swing to Wing because Wing equipment is designed to bring out the best in you.

I know, because I'm helping to design it.

John C. Williams

United States National
Outdoor Champion, 1971
United States National
Indoor Champion, 1971, 1972
World Target
Archery Champion, 1971
World Field Champion, 1972
**OLYMPIC GOLD MEDAL,
MUNICH, 1972**

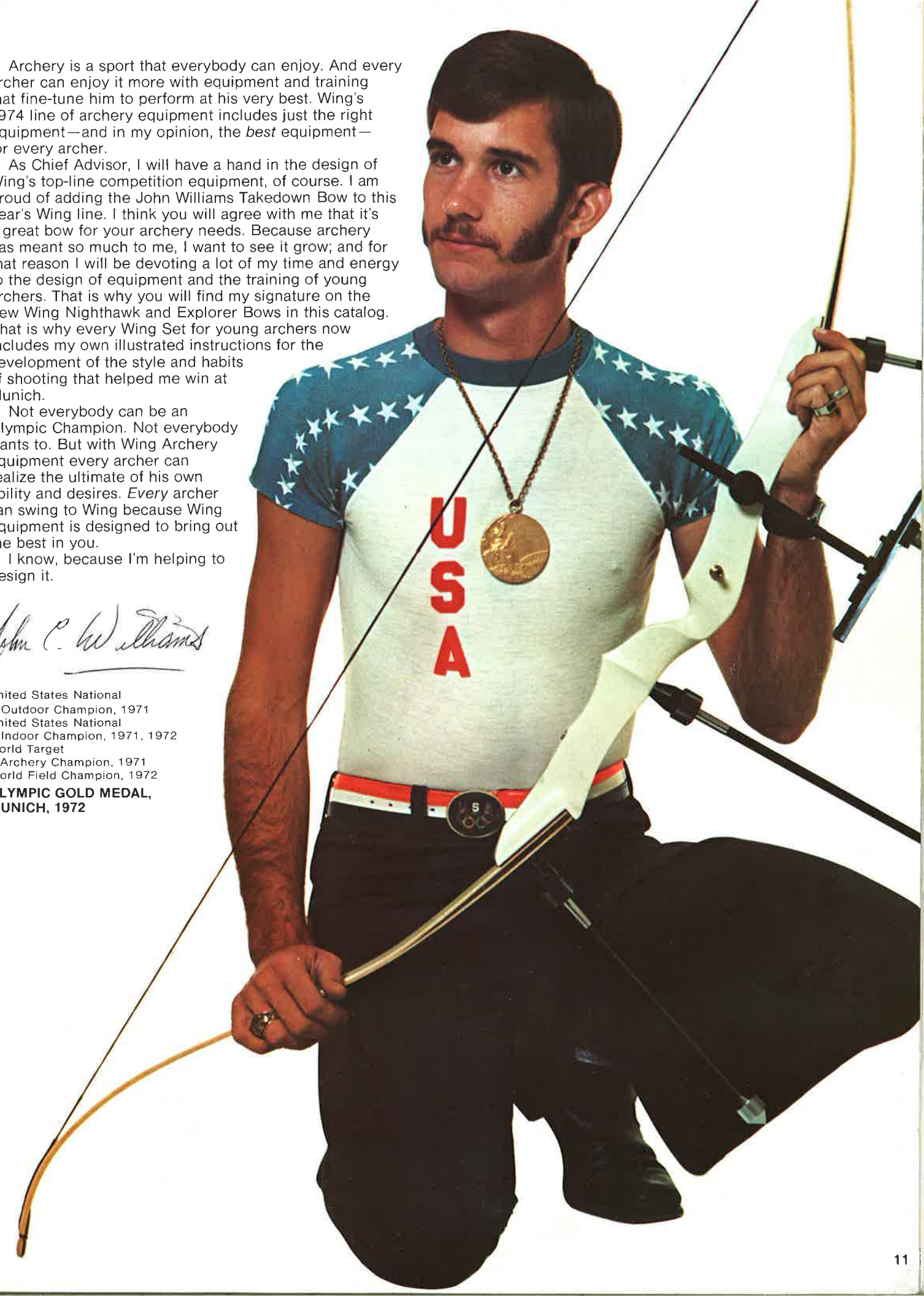

THE COMPOUND BOW BY KETCHUM

1970 Field Archery Champion Frank Ketchum has introduced new, improved design features on the Allen-patented compound bow. The Wing Compound Bow by Ketchum* features smoother cam action, improved limb design, easy tuning, easy tiller adjustment and true limb alignment.

The mechanical advantage of compound action delivers more energy to the arrow with less effort, gives arrow speeds that aren't possible with conventional bows—without sacrificing smoothness. And because you actually hold only about 75% of the full-rated weight, it is easier to hold the Wing Compound Bow by Ketchum at full draw. At the same time, hand torque is not easily transmitted to the arrow.

Interchangeable limbs and handles permit combinations to fit any archer's needs for target-shooting or for hunting. In any combination, the Wing Compound Bow by Ketchum has a smooth, streamlined look to satisfy the esthetic sense of any archer.

With magnesium handles, both hunting and target models weigh in at approximately 3 pounds, 10 ounces—no heavier than many conventional bows!

TARGET MODEL

STANDARD EQUIPMENT

includes stabilizer insert, swinger rest, needle bearings, new Wing cushion plunger, professional bowstring with monofilament serving.

Length: 58", axle-to-axle.

Draw Length: To 34".

Physical Weight: 3 lb., 10 oz.

Fistmele: 9-3/4" to 10".

Limb Weights (peak): 20-30 lb., 30-40 lb., 40-50 lb.

Color: White handle and limbs.

Catalog Order:

140 (complete) Specify high-wrist or standard handle.

142 (high-wrist handle only)

143 (standard target handle only)

145 (limbs only, each)

HUNTING MODEL

STANDARD EQUIPMENT

includes stabilizer insert, bow quiver adapters, needle bearings, hole for new Wing cushion plunger, custom bow string. Leather grip available as no-charge option.

Length: 48", axle-to-axle.

Draw Length: To 33".

Physical Weight: 3 lb., 10 oz.

Fistmele: 10" to 10-1/4".

Limb Weights (peak): 35-50 lb., 45-60 lb., 55-70 lb.

Color: Black handle and limbs.

Catalog Order:

141 (complete)

144 (hunting handle only)

146 (limbs only, each)

*Licensed under Allen pat. #3486495.

140

141

ACCESSORIES

650. Target cable, each.

651. Hunting cable, each.

653. Eccentric wheel, each. Specify size: 1-3/8", 1-1/2", 1-3/4", 2", 2-1/4".

654. Eccentric-wheel axle, keepers and washers, each.

655. Eccentric-wheel bearings, each.

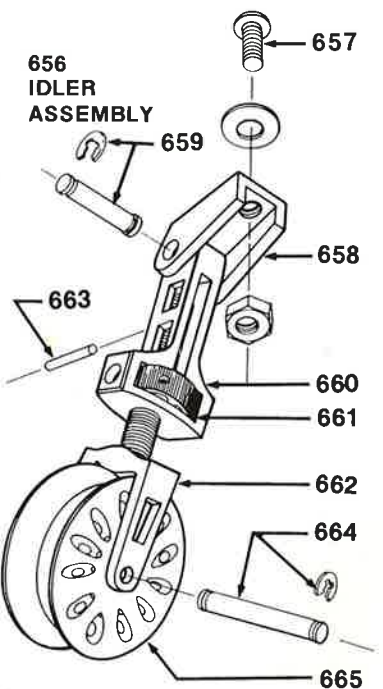

656
IDLER
ASSEMBLY

ECCENTRIC -
WHEEL ASSEMBLY

666
LIMB-COUPLER
ASSEMBLY

667

672. Stabilizers. Specify long (36") or short (24").

672

673. Professional Bowstring, black, monofilament served, for Target Model. Specify 10, 12, or 14-strand.

674. Custom Bowstring, black, nylon served, for Hunting Model. Specify 12, 14, or 16-strand.

675. Padded Vinyl Case. Necessary to protect the Wing Compound Bow by Ketchum. Specify long for Target Model, short for Hunting Model.

656. Idler assembly, adjustable, each.

657. Limb-bracket bolt, washers and nut, each.

658. Limb bracket, each.

659. Limb-bracket axle and keepers, each.

660. Adjustment block, each.

661. Adjustment nut, each.

662. Idler bracket and adjustment bolt, each.

663. Adjustment-bolt slide pin, each.

664. Idler axle, keepers and washers, each.

665. Idler wheel, each.

666. Limb-coupler assembly.

667. Limb-coupler block.

668. Barrel nut.

669. Coupler pin.

670. Limb-weight-adjustment bolt.

671. Cable-lock setscrew.



HAWK SET

Wing's top-quality bowhunting set for the serious hunter. Everything you need for that big hunt. Set includes the Wing Hawk Bow, a versatile, stable, accurate recurve composite bow, and the Wing Bow Quiver, six Hawk Hunting Arrows, glove and armguard, John Williams Instruction Chart, instruction booklet, 24" deer target face.

Catalog Order:
128. (set)
112. (bow only. See p. 5)



BOW QUIVER

The most popular bow quiver made. Light, but rugged enough for lasting service, this quiver is the standard of the industry. The unique design in aluminum and nylon makes arrows rattleproof. It won't scratch, mar your bow, or interfere with shooting. The clamp securely holds six arrows of any size. Right- or left-handed archers can use the same quiver. The Wing Bow Quiver is easy to attach and load, keeps arrows at hand for quick, smooth takeout. Comes with adjustable sliding brackets to attach to any Wing hunting bow in seconds, and with tape-on pads for all other bows. Insert adapter No. 550 for all Wing Bows also available.

Catalog Order:
501. (complete)
502. Arrow clamp.
503. Rod clamps and screws.
504. Tape-on pads.
505. Cup insert.
506. Brackets (complete).
507. Allen wrench.
550. Insert adapter, pair.



508. PRESENTATION II Bow-Quiver Adapters. For use in place of limb bolts on Presentation II Models, to accommodate Wing Bow Quiver.



HUNTING ACCESSORIES

509. RAZORHEAD KIT. 1 doz./pkg.
510. Razorheads less auxiliary blades. 1 doz./pkg.
511. Auxiliary razorhead blades. 1 doz./pkg.



512. HIGH-PRECISION HEADS. Three-blade broadheads, 11/32", 125-grain. 6/ pkg.
513. HIGH-PRECISION HEADS. Three-blade broadheads, 5/16", 100-grain. 6/ pkg.

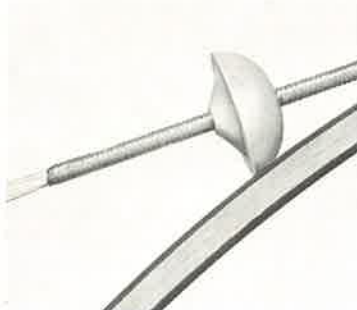

514/515. BRUSH BUTTONS. Soft rubber: brush-proof your bow and quiet string noise. Attach easily, do not interfere with shooting.
514. Regular.
515. Super.



516. SAUNDERS KWIK-LOK ARROW HOLDER. Holds arrow in bow for hunting. Releases instantly on draw. Keeps arrow ready for action.



517. STRING SILENCER. Eliminates bowstring noise. A must for hunters. 2/pkg.



518. BOHNING DRI-TITE WATERPROOFING. Waterproof your feathers. Dri-Tite does not stiffen feathers. 12 bottles/box.

519. KWIKEE KWIVER. The lightweight bow quiver that snaps on and off in seconds. Six pairs/display carton.
520. KWIKEE KOVER. Covers broadheads to protect hunter. Attaches instantly.



521. BUCK LURE. Attracts deer and camouflages human scent.



522/523. BURNHAM GAME CALLS. "Callingest" calls made. Of unbreakable Tenite.
522. Long-range varmint call.
523. Close-range varmint call.



825. WING PATCH. Distinctive, colorful: official sew-on patch.



825. KAMO MAKEUP KIT. Easy-to-apply camouflage paste. Use very small amount. Easily removed with soap and water, yet unaffected by rain or perspiration. Contains insect repellent. Two tubes—forest brown and leaf green—in plastic box.

530. CAMOUFLAGE BOW COVER. Genuine five-color cotton camouflage cloth.
531. HEAD NET. Fits over cap and face. Bars insects. Easy to see through. Drawstring adjustment.





RAW ALUMINUM SHAFTS, POINTS AND ADAPTERS

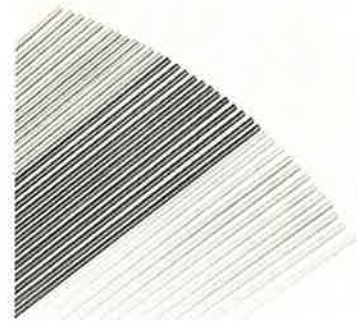

(Points included except as noted.)

301. EASTON X7. Sizes 1614, 1714, 1814, 1914, 2014, 1516, 1616, 1716, 1816, 1916.

353. EASTON XX75. Sizes 1416, 1516, 1518, 1616, 1618, 1713, 1716, 1718, 1813, 1816, 1818, 1820, 1913, 1916, 1918, 1920, 2013, 2016, 2018, 2020, 2114, 2117, 2214, 2219.

354. EASTON 24SRT-X. Sizes same as XX75, plus 1413, but no 2117.

302. WING TARGET. Sizes 1516, 1616, 1716, 1816, 1916, 1718, 1818.

303. RED WING HUNTING. Sizes 1916, 1918, 2016, 2018, 2020, 2219. Broadhead adapters included. No points.

355. EASTON SWIFT. Sizes 1413, 1416, 1516, 1616, 1716, 1816, 1916, 2016, 1518, 1618, 1718, 1818, 1918, 2018, 1820, 1920, 2020, 2117, 2219. Target points or broadhead adapters included.

NOTE: All Easton shafts and points, except 302, Wing Target, and 303, Red Wing Hunting, must be ordered in minimum quantities of five dozen shafts. These may be all of one alloy, or in combinations.

305. EASTON X7 INSERT TARGET POINTS.

306. TWO-PIECE INSERT TARGET POINTS.

307. SPECIAL HEAVY INSERT TARGET POINTS X7.

356. SWIFT INSERT TARGET POINTS.

308. BROADHEAD ADAPTERS, 5° taper.

WING GLASS SHAFTS, POINTS AND ADAPTERS

The finest glass shafts available. Unaffected by heat or moisture, extremely strong. Full-length only.

304. WING GLASS SHAFTS. Sizes A-K (correspond to Sizes 1-11).

309. NOCK INSERTS. Specify shaft size.

310. TARGET POINTS. Specify shaft size.

311. BROADHEAD ADAPTERS. Specify shaft size.

WING CEDAR SHAFTS

349. Top-grade Port Orford cedar. Matched in spine and weight. Parallel 21/64" shafts, 1 dozen/package. Specify bow weight.

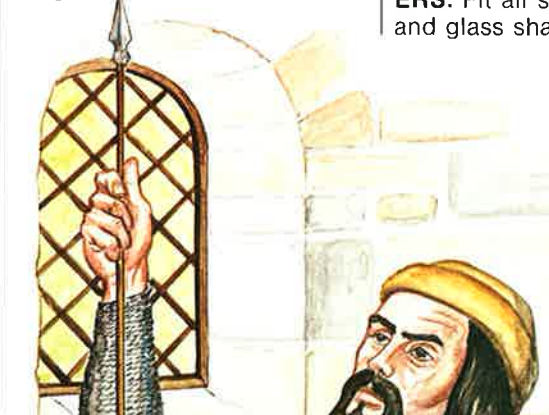

WING "SWITCH-A-POINTS"

Fit "Switch-A-Point" arrows and shafts on page 9. Aluminum shaft sizes 1916, 1918, 2016, 2018, 2020, 2219; glass shaft sizes F-K (correspond to 6-11) and 7-11.



312/313. INSERTS.

312. For aluminum shafts.

313. For glass shafts.



314/315. 125-GRAIN FIELD POINTS.

314. For aluminum shafts.

315. For glass shafts.



316/317. 125-GRAIN BLUNT POINTS.

316. For aluminum shafts.

317. For glass shafts.



318. BROADHEAD ADAPTERS. Fit all sizes of aluminum and glass shafts.



MILLER MASTER FLETCHER

The perfect precision fletcher for the archer who likes to build his own arrows. All the features of the best equipment available, including magnetic clamp-holders, feather spacing of 90°, 120°, and 75°-105°.

322. With straight clamp.

323. With helical clamp (left wing).

324. Extra straight clamp.

325. Extra helical clamp (left wing).



MILLER STANDARD FLETCHER

326. A low-priced precision fletcher with feather-spacing adjustments usually found only on higher-priced tools. Complete with straight clamp.

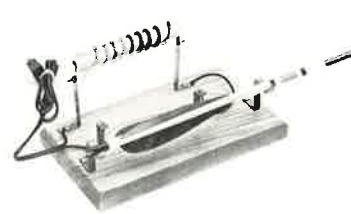

FLEETWOOD FEATHER-TRIMMER KIT

329. Economical feather-burner kit with mounting board included. All holes predrilled.

330. Extra wire.



TAPERING TOOL

331. Available with 1/4", 9/32", 5/16", and 11/32" bushing. Uses regular injector-razor blades.



FLEX-FLETCH FLETCHING

Revolutionary Flex-Fletch springs back to life even when your arrow completely penetrates the target. Amazingly flexible and durable, Flex-Fletch can be pushed or pulled through the butt if the arrow hits a soft spot. Absolutely waterproof and unaffected by temperature. Easily applied with jig or cement. So sturdy it usually outlasts the arrow! In white, green, brown, fluorescent red, orange, yellow.

360. Parabolic 2-in.

361. Parabolic 3-in.

362. Hunting and field 4-in.

363. Hunting 5-in.



CEMENTS

332. BOHNING FLETCH-TITE.

Superior fletching cement for aluminum or wood. Air-dries rapidly. Does not grow brittle with age. Waterproof.

333. ROBIN HOOD FLETCHING CEMENT. Excellent for feathers, vanes and nocks.

334. EASTON 24SRT-X CEMENT. Especially formulated for aluminum arrows. For nocks, feathers or vanes.



BOHNING FERR-LITE. The perfect cement for attaching points to arrows. In stick or liquid.

335. Liquid.

336. Stick.



348. POINT-FAST EPOXY ADHESIVE. Perfect for attaching nocks and points to glass shafts. Excellent for any repairs.

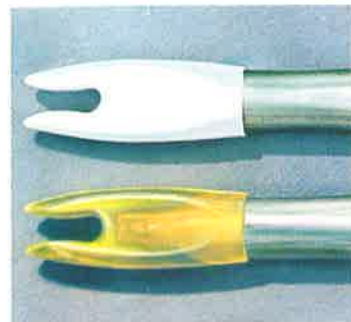

TARGET/FIELD POINTS.

Parallel hole, zinc-plated steel.

342. 5/16".

343. 11/32".



TAPERED BLUNTS.

125-grain, tapered hole.

344. 11/32".

345. 5/16".



TARGET POINTS.

Parallel hole, zinc-plated steel.

346. 11/32".

347. 5/16".



FEATHERS.

Die-cut left-wing, top-quality ground base. Parabolic shape. Specify white or dyed-white. Specify color: black, red, orange, blue, green, yellow, white. Packed 3 doz./pkg.

350. 3-in. feathers.

351. 4-in. feathers.

352. 5-in. feathers.

Arrow Making:
The time-honored art

EUROPE,
1200 A.D.

America,
1800

America
today



LEATHER GOODS

403. WING TOURNAMENT QUIVER. Handy belt quiver with top snaps on or off without having to remove belt. Lightweight vinyl. Economically priced.

404. WING PRO QUIVER. An excellent side quiver of top-quality vinyl. Designed to meet specifications. Complete with belt clip, scorecard pocket and large zippered pocket for accessories. Divider strap. Black only. Specify right or left.

402. WING HOLSTER QUIVER. Quality vinyl and comfortable styling make this a popular holster quiver. Beautifully trimmed and stitched. Large accessory pocket with Velcro closing flap. Scorecard and pencil pockets. Divider loop. Black only. Specify right or left.

405. STUDENT BELT QUIVER. Tough, leather-like material. Belt loop. Holds 6-8 arrows.
406. PADDED BOW CASE. Leather-grained vinyl with 3/8" padded lining. Carrying handle. Specify length: 52", 62", or 66" (66" case will accommodate bows to 72").

407. FLANNEL BOW CASE. Durable flannel with soft nap finish. Tie-down flap. 6" wide. Specify length: 63" or 72".

409. PRESENTATION II PADDED VINYL CARRYING CASE. Made especially for the Presentation II, this attractive zip-up case handsomely holds one set of limbs and one handle. Pockets provided for stabilizer and bowsight. Offers protection for equipment and convenience to the archer who wants to save space when traveling to tournaments or on hunting trips.

428. HUNTER BELT QUIVER. Ready for action, the Hunter Belt Quiver holds six broadheads that can be drawn on a moment's notice. Known as the "quick draw" holster of archery, the Hunter Belt Quiver comes complete with shaft separators and foam-rubber inside bottom to protect blade heads. Belt tunnel and tie-down thongs. Adjustable for right or left hand.

431. METAL GROUND QUIVER. Holds arrows while shooting and bow while retrieving arrows. Vinyl-coated push-in bar holds bow firmly.



410. TAN DOUBLE-SEAM GLOVE. Closed end, soft leather tip. Specify size: S, M, L or XL.



411. BROWN SINGLE-SEAM GLOVE. Open end with heavy-duty elastic. Specify size: S, M, L or XL.



412/413. PRO GLOVE. Top-quality, form-fitting, double-seam glove with closed end tips. Elastic webbing ensures perfect fit. Black. Specify size: S, M, L or XL.

412. Cowhide.

413. Corfam.



414. WILSON TAB. Improved tab from Wilson is cut to fit more comfortably than ever. Felt finger fenders provide excellent protection. Right or left hand. Specify size: S, M or L.



415. RING TAB. One of the most comfortable tabs available. Two size rings with each tab to insure fit. Eliminates finger irritation. Soft, leather-backed. Available in Cordovan or Hair. Right or left hand. Specify size: S, M or L.



416. COWHIDE TAB. Soft leather-backed. Right or left hand. Specify size: S, M or L.



417. ARM GUARD - JUNIOR. Split leather. Two elastic loops. Jiffy hook fastener.



420. ARM GUARD - HUNTING. Larger armguard for hunting. Three steel reinforcing rods. Velcro fasteners.



421. ARM GUARD - RANGE. For maximum protection. 11-1/2" long. Four steel reinforcing rods. Ventilated. Velcro fasteners.



418. ARM GUARD - TARGET. Top-quality leather and stitching. One steel reinforcing rod. Velcro fasteners.



419. ARM GUARD - VENTILATED. Field or hunting guard. Ventilated for comfort. Three steel reinforcing rods. Velcro fasteners.



422. ARM GUARD - RANGE. For maximum protection. 11-1/2" long. Four steel reinforcing rods. Ventilated. Velcro fasteners.



423. STANDARD BOW SLING. A must for tournament shooters. Keeps bow securely in hand. Self-adhesive, fastens easily on bow.



430. BRE-ZEE VENTILATED ARM GUARD. Features cool, open design. Made of tough polyurethane to resist cracking and curling. Attaches easily and is instantly adjustable. Assorted Colors. 12/pkg.



431. METAL GROUND QUIVER. Holds arrows while shooting and bow while retrieving arrows. Vinyl-coated push-in bar holds bow firmly.



432. BOW SADDLE. Self-adhesive, installs in seconds. Eliminates bow slipping in hand.



425. CHEST PROTECTOR. The only really cool protector available. Elastic lacing allows perfect fit. Completely adjustable. Specify: size, S or L; right- or left-handed; black or white.



BOWFISHING ACCESSORIES

WING BOWFISHING KIT

Everything you need to enjoy the exciting sport of bowfishing is in Wing's Complete Bowfishing Kit. A 50-foot line of strong braided nylon, a smooth-feeding reel with attached bracket for easy taping to bow (or a new quick-attach model that screws onto all Wing Hunting bows), and the toughest fiberglass arrow made—complete with easy-off, case-hardened harpoon head—make up Wing's complete bowfishing kit.

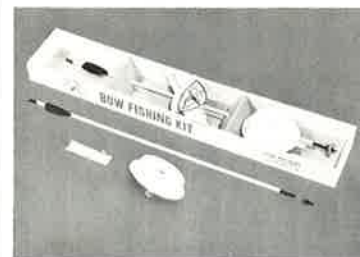

601. COMPLETE KIT (excluding bow) with double-barbed point (No. 607) and improved tape-on reel and line (No. 604).

602. Same as No. 601, with Quick-Attach Reel (No. 603).

603. IMPROVED QUICK-ATTACH REEL AND LINE. Complete with 50 feet of nylon line. Quickly screws into the stabilizer insert on all Wing hunting bows.

604. IMPROVED TAPE-ON REEL AND LINE. Complete with 50 feet of nylon line. Fits all hunting bows.

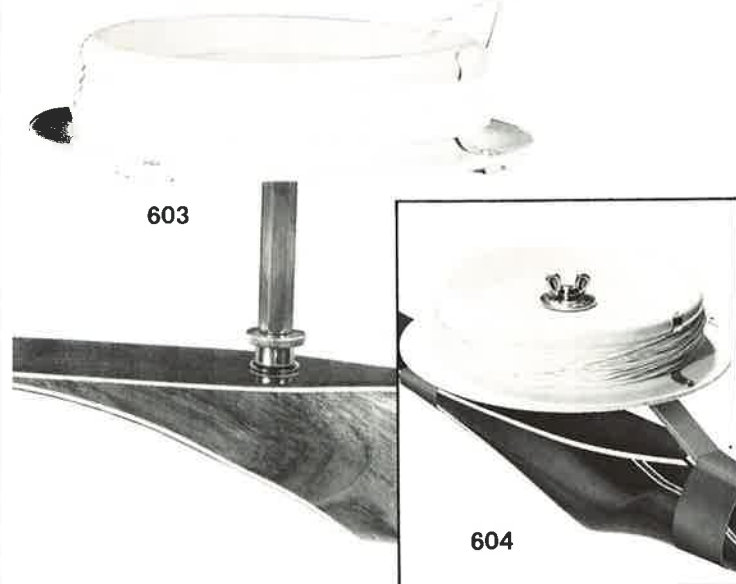

605. LAYFLETCHED ARROW. With Easy-Off Point (No. 607).

606. LAYFLETCHED ARROW. Without point.



607. EASY-OFF HARPOON HEAD. Double-barbed. With case-hardened Easy-Off Tip.

608. EASY-OFF TIP. Extra, double-barbed.

609. Extra **EASY-OFF SHANK.**

610. NYLON LINE. 50-foot braided line.

611. Extra **LAYFLETCH.**



614. STINGAREEFISH POINT. Double-barbed point. No time lost removing point. Closes completely for removal from fish. Automatically opens to 2" on drawback when retrieving game. Perfect for the big ones!



613. MAC'S BOW REEL. A sturdy 11-1/4"-diameter solid steel reel with detachable tape-on brackets. Mounts so that arrow is shot through center of reel. Assures even feed-off of line. Complete with 70 feet of 80-pound-test nylon line. Fits all bows.



BOWSTRINGS, ARROW RESTS, STRING ACCESSORIES

701. CUSTOM BOWSTRINGS.

This continuous-fiber Dacron polyester thread ensures longer string life. Specify bow weight (15 through 80 lb.). Specify length: 52", 54", 56", 58", 60", 62", 64", 66", 68", 69", or 70". Strings for hunting bows (52"-62" and 12 strands or over) are black.

STRAND CHART

Up to 25 lb.:	8
25-35 lb.:	10
35-45 lb.:	12
45-55 lb.:	14
55 lb. and up:	16

702. PROFESSIONAL BOWSTRINGS. For the exacting archer. Extra-strong double-loop black Dacron polyester string with full monofilament serving. Specify length: 66", 68", 69", 70" or 72". Specify bow weight: 15 through 55 lb.

730. DOUBLE-LOOP BOWSTRING. With center serving. Specify length: 48", 50", 52", 54" or 56". Weight: up to 40 lb.



POSI-NOCK. Positive nocking points. Positions string peep. Easy to clamp on string.

731. For 11/32" nock.

732. For 5/16" nock.

733. For 9/32" nock.

734. For 1/4" nock.



735. Single. For all nock sizes.



703. PRO-TECTO-TIP. Lightweight plastic protects bow tip. Holds string securely in place. Specify size: standard (red) or large (blue).



704. NOCK-RITE. Ensures fast, accurate shooting with no slippage of arrows on string.



706. NOK-SET. Positive nocking point. Guaranteed not to slip. Adjusts to any bowstring diameter. Package of 5. Specify size: T (target) or H (hunting).

707. Dealer Package of 100.

708. Nok-Set Tool only.



709. KISSER BUTTON. Slips onto string easily. Adjusts merely by turning. Ensures proper anchor. 12 on a card.



710. POTAWATOMI BOW SQUARE. Helps measure brace height, locate nocking point. Also helps locate kisser button and string peep.



711. HOYT KLICKER. Easily mounted on bow. Perfect draw check. Self-adhesive. A sure help for freezing.



723. "TICKER" DRAW CHECK. "Tick" tells you when you reach full draw. Improves aiming and gives the same draw for each shot. Adjusts to arrow length, draw. Precision-made stainless-steel base and tempered steel ticker spring. 5" long.



724. ADJUSTABLE "TICKER" DRAW CHECK. Similar to 723, but has fine adjustment so that archer may vary draw without removing "ticker" from the bow.



725. NEW EVANS REST. Fits entirely under arrow. New delicate spring action allows better action and lighter spring tension on rest. Pressure-sensitive adhesive allows easy application. Right or left hand.



712. WING FLIP REST. Ideal for either target shooting or hunting. Specify right or left hand.



713. WING FEATHER REST. Insures smooth arrow flight. Horizontal feathers mounted on leather. Self-adhesive for easy installation. Specify right or left hand.



714. HOYT PRO REST. Non-interfering rest with pressure plate that provides for positive clearance of vanes or feathers. Magic retaining finger prevents arrow from falling off rest. Flexible shaft prevents arrow bounce. Self-adhesive backing. Specify right or left hand.



715. ARROW PLATE AND REST. Adhesive-backed arrow plate and arrow rest ensure quiet drawing and shooting for hunters.



722. "SWINGER" ARROW REST. Precision made of stainless steel and tempered spring wire. No springs to break. Torque action lets arrow pass with minimum interference. Returns to same position for each shot. Easily attached to bow with adhesive-backed plate. Use on bows with or without pressure plunger. Target or hunting. Right- or left-hand models. Increases accuracy for competitive shoots.

717. TYPE "B" DACRON POLYESTER STRING. Prewaxed Dacron polyester ensures that you will make the longest-lasting, finest string possible.



718. "SPEED-SPIN" STRING SERVER. Complete with nylon thread. Provides fast, perfect servings.

719. EXTRA NYLON THREAD. Specify color: red, black, blue, green, yellow, white.

720. EXTRA MONOFILAMENT SERVING THREAD.



721. BOWSTRING WAX. Will make your bowstrings last longer.



727. NEW CUSHION PLUNGER. Adjustable for windage and plunger spring tension. Most popular tuning aid for the precision shooter.

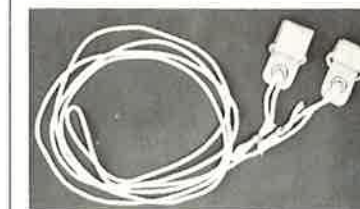

716. WING BOW STRINGER. A must for any archer. The only way to ensure safe bow stringing. Anyone can string heavy bows with ease. Prevents limb twisting. Protects archer. New enlarged pockets easily accommodate any tip.

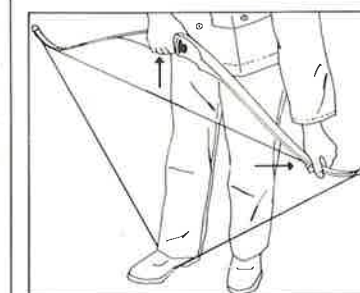



BOWSIGHTS AND STABILIZERS



801. CAVALIER BOWSIGHT. Positive windage and elevation locks. All-metal construction. Unique, wide locking nut works easily and efficiently. Hooded pin aperture. Will accommodate any two-wire aperture.



802. REYNOLDS BOWSIGHT. Removable, double-adjustable bow sight. 10 to 100 yards' elevation adjustment. Sight takes prism, pins or double-wire apertures. Vertical adjustment further compensates on "heavy" days.

803. Extra REYNOLDS BASE.

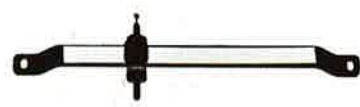

804. CAVALIER BASIC SIGHT. All-metal construction. Wind and elevation adjustments with positive lock. Post sight with red pin.

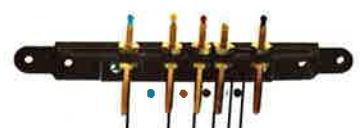

805. RAINBOW HUNTING SIGHT. For instant and accurate sighting in the field. The Rainbow Hunting Sight has color-coded pins that can be preset for five distances. Blue, red, yellow, white and black dots can easily be seen on a plastic rangefinder. Fits any size bow for easy installation.



806. WING SIGHT EXTENSION. Easily mounted on side of bow. Can be extended forward or backward. Has vertical adjustment to align sight with bowstring. A must for tournament shooters who want perfection.



807. UNIVERSAL ADAPTER BAR. For Wing Sight Extension. For longer sight bases.



808. SIGHT EXTENSION BASE.



810. STRING PEEP. Unbreakable hard vinyl. Inserts easily in string. Serves as rear sight. Round hole.



812. WING HUNTING STABILIZER. Improves accuracy and quiets bow. Flex-coupling gives both stabilization and smoothness. Fits Wing Stabilizer inserts.



824. FLEXI-COUPLER. For a consistently accurate shooting average, the Wing Flexi-Coupler allows the bow to move during the shooting sequence while the lightweight tubular rod and weighted head remain relatively stable. Gives truer sight and added stability for arrow. The Flexi-Coupler faster damping action decreases the shock and vibration of the bow limbs after the arrow is released. Black.



815. SIGHT APERTURE. Has 5/8"-diameter hood with level. Mounting wires are all chrome-plated and permanently attached.



WING STABILIZER. Fits any bow. The dynamically designed head and black anodized aluminum rod put stability into your shooting and let you adjust to different conditions. Rod fastens easily into the bow insert.

816. STABILIZER SET. One rod and one weight. Specify length: 22", 15", or 10".

817. ROD. Specify length: 22", 15", or 10".

818. WEIGHT. 3-3/4 oz.

819. WEIGHT. 6 oz.

820. INSERT.



540. STABILIZER ADAPTER BOLTS. Allow for twin stabilizers on Presentation II limb. Adapter is tapped to receive stabilizer.



822. WING HUNTING SIGHT. Fully adjustable, quick-attach bowsight. Four completely adjustable sighting bars. Set all four for predetermined distances. It's quicker, more accurate and more dependable. Each sighting pin is color-coded for immediate distance recognition. All four pins adjust both vertically and horizontally. Sight attaches quickly to any bow. Mounting screws are furnished with sight. Specify right or left hand.

860. NEW CAVALIER PROFESSIONAL SIGHT. New professional sight allows for extremely easy movement of sight block with positive locking. Fine adjustment for both elevation and windage. Spring-loaded to prevent accidental movement. Spring-loading is adjustable. Comes with drop pin and level. Fits Wing Sight Extension without adapter plate.



860. NEW CAVALIER PROFESSIONAL SIGHT. New professional sight allows for extremely easy movement of sight block with positive locking. Fine adjustment for both elevation and windage. Spring-loaded to prevent accidental movement. Spring-loading is adjustable. Comes with drop pin and level. Fits Wing Sight Extension without adapter plate.

861. SIGHT BAR.
862. SIGHT BLOCK.
863. APERTURE AND LEVEL.



DEALER AIDS



KILLIAN SIGHT. To zero in on target every time, the Killian Sight has a windage adjustment, a bubble level adjustment and a yardage-pin corrector. The sight is made of sturdy black anodized aluminum and is suitable for either right or left hand. Fits "Chek-It" Bar and other sight bars. Easy to mount on almost any bow. A must for hunting or target shooting!

880. KILLIAN SIGHT. Sight block and sight bar.
881. 8" EXTENSION AND MOUNTING.
882. ADAPTER PLATE. For Wing Sight Extension.
883. APERTURE AND LEVEL.
884. DROP PIN AND LEVEL.
885. "CHEK-IT" SIGHT BAR.
886. BLOCK AND SIGHT.
887. MINI-BLOCK.
888. MICROMETER ADJUSTMENT. Complete. Fits all Killian "Chek-It" extended bars with nylon slide bar. Easy to install.



390. WING DEALER ACCESSORY DISPLAY. Exhibits fast-moving accessory items packaged in plastic-bubble cards. Sturdy steel rack holds up to 120 cards. "Wing Archery Headquarters" banner sign attaches to rack.



726. WING DEALER BOWSTRING RACK. A functional and appealing sturdy wire rack. Designed to hold 75 Wing Bowstrings in plastic tubes. "Wing Bowstrings" banner attached.

WING IT! Make full use of Wing Archery Division's dealer aids. The full line of in-store displays is complemented with a wide selection of films, books and other items for use by schools, archery clubs and civic groups. Wing dealer aids are great ways to build local interest in archery as a sport and to build sales of fine archery equipment.



SHIRTS



535/536/537. OFFICIAL WING SHIRTS. This comfortable shirt comes with the Wing name embroidered on the chest. The material and styling allow for plenty of action. Specify color and size: Red, white or blue; S, M, L.

535. SMALL.
536. MEDIUM.
537. LARGE.



255. WING RAVEN ARROW DEALER PACK. Attractive packaging of Raven wood practice arrows. Each has crest, full-painted shaft and 3" fletch. Target points only. Packed in half-gross display cartons containing 3 dozen each of 26" and 28" arrows unless otherwise specified. Not recommended for bows over 40 lb.

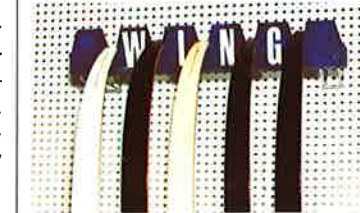

874. PEGBOARD HANGER. Holds 5 bows. Saves space. Removes pressure on bow limbs to prevent warping. Has various pegboard holes for multi-hanging arrangements.

TARGETS

Printed in full color, targets and target faces are available in two types of stock: Tear-Resistant Tag Stock and Toughenized Stock which last much longer than regular faces.

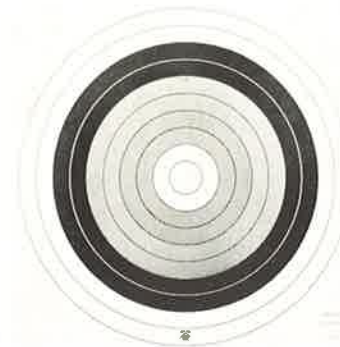

COLOR TARGETS

Toughenized:

- 835. 16" square.
 - 836. 24" square.
 - 837. 36" square.
 - 839. 48" square, official NAA.
- Tear-Resistant Tag Stock:
- 840. 16" square.
 - 841. 24" square.
 - 842. 36" square.
 - 843. 48" square, official NAA.



845



846



847

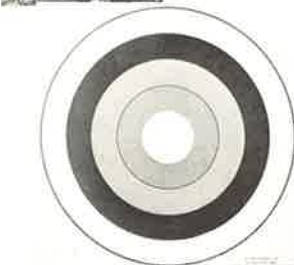

844

COLOR FACES

Printed on extra-heavy paper.

- 844. 24" square, 2/pack.
- 845. 24" deer, 2/pack.
- 846. 18" fox, 3/pack.
- 847. 12" bobcat, 4/pack.

FILMS AND BOOKS

829. SHARK HUNTING WITH BOB LEE. 19 minutes of hard-hitting action, spine-tingling excitement as Bob Lee stalks the man-eater shark on a bow-fishing expedition in the Gulf of Mexico. Sure to create new interest and stimulate sales. Order this film right away.

830. HONDO JAVELINA. We took our cameras along to capture on film an incredible contest of skill between Wing's Bob Lee and the wiles of the ferocious fighter, the Javelina. Don't miss it! Make reservations today for your archery, civic or community action club.

831. 7 STEPS TO GOLD. An excellent way to teach archery. Comprehensive instructions on how to teach and how to shoot are covered in this enlightening and entertaining film. John Williams and Jim Ploen are featured in the film.

834. ELK HUNTING WITH BOBLEE. Go with Bob Lee and John Culpepper to New Mexico high country in search of the elusive bull elk. Enjoy the thrill of being in nature and of seeing many wild animals.

Request reservations from:
WING FILM SERVICE
Route 1
Jacksonville, Texas 75766
Include \$5 rental fee. Specify alternate dates in the event that we are unable to meet your preference.

BOOKS CAN IMPROVE SKILLS AND INCREASE ARCHERY ENJOYMENT 828. "ANSWERS TO ARCHERY" BOOKLET. Anyone can learn to shoot, and this book tells how. "Answers To Archery" contains detailed instructions and a glossary of terms for the beginning archer. All the information needed to start off right.

833. "ARCHERY TIPS FOR THE COACH AND TEACHER" BOOKLET. Gives pointers on all phases of archery. Included are such topics as warmup, stance, nocking, string alignment, aiming, releasing, follow-through and more. Author Jim Ploen also discusses principles of muscular physiology that can be applied to archery, basic archer-shooting analysis, equipment needs and isometric exercises to get you in shape for shooting. Excellent for classroom and archery clubs.

832. "WINNER OR LOSER". The pressures, problems and psychological aspects of sporting competition. "Winner or Loser" is a factual analysis based on 16 years' experience of a successful competition shooter, Shig Honda. A must for advanced archers.

WARRANTY:

Your purchase from an authorized Wing dealer is protected. Each Wing bow is numbered, and you receive a registration card for your bow when you buy it. Fill out and mail the card within 10 days of purchase.

If your registered bow fails within six months of purchase date, Wing Archery will repair it free or replace it if it is not repairable. The warranty does not cover bows that fail because of misuse, improper handling, or limb damage caused by improper stringing.

Repair or replacement will be made for one-half the purchase price after six months and up to 36 months after purchase date.

You must return the bow to us for inspection. Replacement will be made with a bow of the same model and weight or the closest model available.

This warranty is valid only for bows purchased from authorized Wing Dealers, but dealers are not authorized to make adjustments. REPLACEMENT IS MADE ONLY BY THE FACTORY SERVICE DEPARTMENT.

This warranty is transferable from one owner to another, provided the original owner registers the bow at the time of purchase.

If the normal requirements of the Wing warranty are met, Wing takedown bow handles carry a full replacement or repair warranty for three years.

The normal three-year warranty that applies on one-piece bows also applies to the takedown limbs. Limb replacements will be made only in pairs. Single limbs cannot be supplied.

The words WING and WINGWOOD are registered trademarks of AMF Incorporated.

PLEASE NOTE:

Wing orders are filled with all care and speed possible. To avoid delays, please check your order carefully before mailing to make sure you have furnished all catalog numbers, bow weights and lengths, as applicable. Also, be sure arrow information is complete, including arrow lengths and bow weights.

Your local Wing dealer takes pride in helping you select proper equipment. If no dealer is nearby, write us and we will direct you to the nearest dealer.



AMF/Wing Archery Division
Route 1
Jacksonville, Texas 75766

ARCHERY ORGANIZATIONS

National Field Archery Association (NFAA)
Route 2 Box 514
Redlands, California 92373

National Archery Association (NAA)
2833 Lincoln Hiway East
Ronks, Pennsylvania 17572

American Indoor Archery Association (AIAA)
P. O. Box 174
Grayling, Michigan 49738

Archery Manufacturers Organization (AMO)
618 Chalmers
Flint, Michigan 48503

Professional Archers Association (PAA)
1500 N. Chatsworth St.
St. Paul, Minnesota 55117

The Pope and Young Club
P. O. Box 1
Squaw Valley, California 93646



AMF/Wing Archery Division Plant

Come to the piney woods of East Texas and visit us at our Wing Archery plant. Located in Jacksonville, the plant houses the workers and machinery responsible for the fine quality of the Wing Archery equipment.

A tour of the plant would show you the production facilities, warehouse space, arrow manufacturing and shipping departments. These facilities are kept up-to-date so that the production levels can be maintained or increased and so that we can keep quality and service high without costs skyrocketing.

Research and development personnel constantly investigate methods of improving products

while discovering new ideas for the future.

Fine sporting goods dealers know that Wing builds in quality by using the best methods possible. And backing up this technology is the pride and craftsmanship which comes from all the employees. Most of the employees are also archers, and they know how much small details matter in competition shooting and hunting.

The next time you are in East Texas, come by the plant and let us show you through the manufacturing process so that you can fully appreciate the dedicated effort these men and women put into the production of Wing bows and arrows.



Route 1, Jacksonville, Texas 75766
214/586-2416

EXPORT SALES OFFICE: AMF INCORPORATED
SPORTS PRODUCTS GROUP—International Division
777 Westchester Avenue, White Plains, New York 10604
Phone (914) 694-9000 * Cable AMMAFOCO, White Plains