

JOHNSON UTILITIES, LLC
 CONSTRUCTION SPECIFICATIONS
 REV 06/20

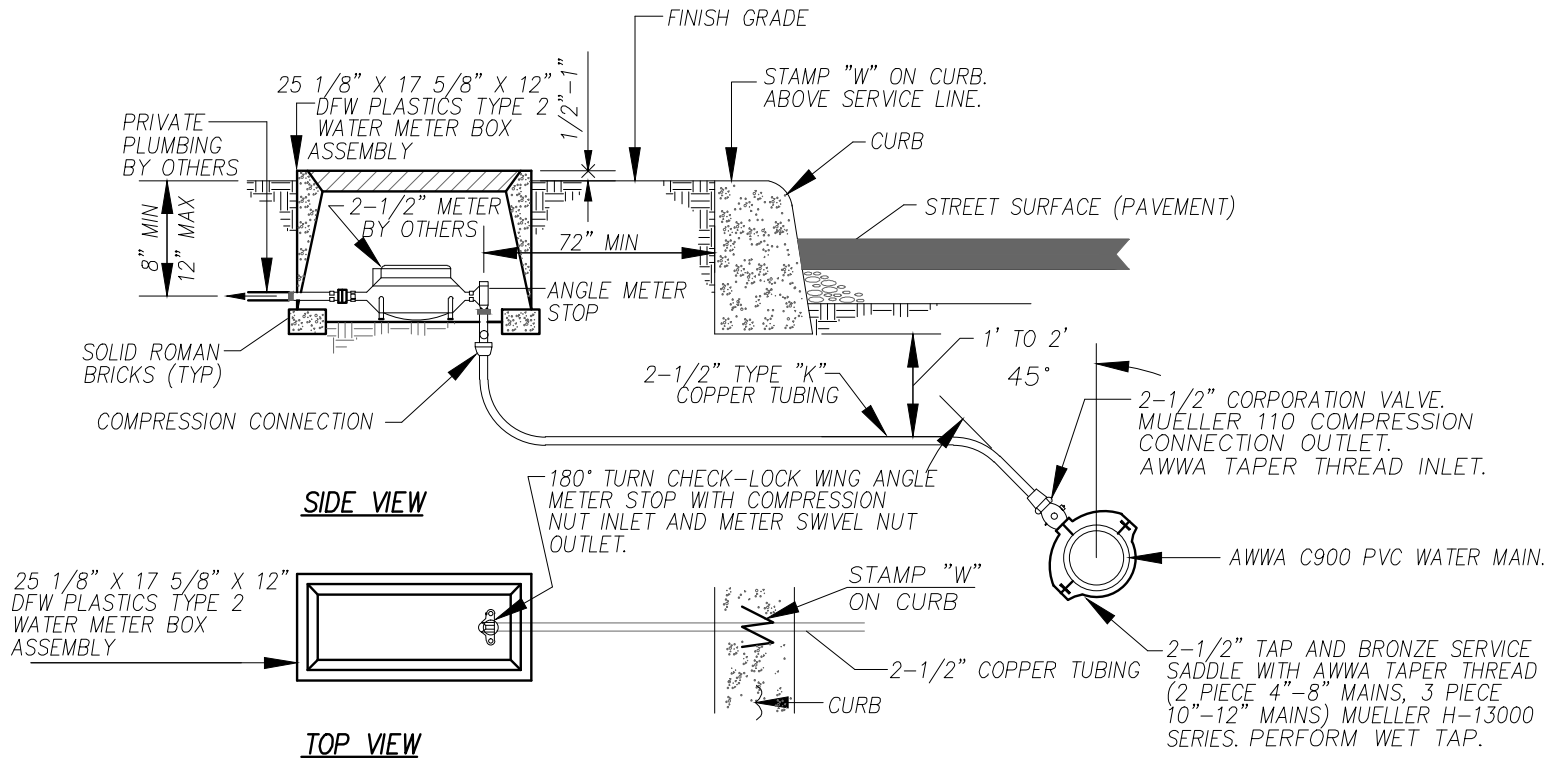

2-1/2" SERVICE INSTALLATION DETAIL

(OR APPROVED EQUAL)

N.T.S.

NOTE: ALL METER BOXES SHALL HAVE HOLE DRILLED
IN METER BOX COVER PER DETAIL JU-3106

JU-3104