

Mini, Small, Medium, Large

Canadian Suggested Retail Price List in USD
Sep-18

Phone: 260-665-2769

Fax: 260-665-3047

Email: iim@mobility-usa.com

www.mobility-usa.com

Quote: _____

P.O. _____

Bill To

Dealer: _____ Contact: _____

Address: _____

City: _____ State: _____ Zip: _____

Phone: _____ Fax: _____

Email: _____ Mark For: _____

Ship To

Same as Bill To _____

Dealer: _____ Contact: _____

Address: _____

City: _____ State: _____ Zip: _____

Phone: _____ Fax: _____

Email: _____ Mark For: _____

Grillo Features and Specifications Mini, Small, Medium, Large

- **Quick Adjustment** - Grillo adjusts easily and tool-free for user growth, transportation, or multiple patient use.
- **Easy Transport** - In just one motion, Grillo folds into a small compact unit easy to transport. No tools required.
- **Exclusively-Designed Wheels** - Grillo wheels come standard with anti-rollback, independently adjustable tension drag, and brakes. The wheels are suitable for indoor and outdoor use.
- **Chest & Pelvic Supports** - Padded and adjustable in angle, height, inclination, and circumference. The chest and pelvic supports work independently.
- **Ergonomic Harness** - The harness supports the user if necessary without generating pressure and is breathable, adjustable, and removable.
- **Measurement Bars** - allow for quick, easy, and accurate adjustment.
- **Grillo** - has the widest range of height adjustment on the market.

Grillo Frame Options

Part Number	Description	Price (USD)
____ GRA	Grillo Frame Mini requires GR824, GR930, and GR835	\$1,805.00
____ GRP	Grillo Frame Mini requires GR824, GR930, and GR835	\$1,805.00
____ GRA-1/2	Grillo Frame Small requires GRI924-1/2, GRI950, and GR835	\$1,900.00
____ GRP-1/2	Grillo Frame Small requires GRI924-1/2, GRI950, and GR835	\$1,900.00
____ GRA-3/4	Grillo Frame Medium requires GRI924-3/4 GRI950, and GR835	\$2,190.00
____ GRP-3/4	Grillo Frame Medium requires GRI924-3/4 GRI950, and GR835	\$2,190.00
____ GRA-5	Grillo Frame Large requires GRI924-5 GRI950-5, and GR835	\$2,690.00
____ GRP-5	Grillo Frame Large requires GRI924-5 GRI950-5, and GR835	\$2,690.00

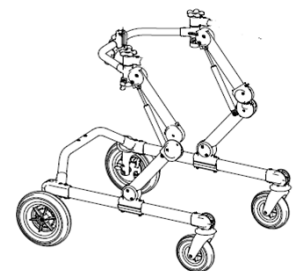

Support Options

Part Number	Description	Price (USD)
MAY SELECT UP TO ONE SIZE SMALLER OR LARGER FROM FRAME SIZE		
_____ GR824	Pelvic Support Mn each support is 11.5" long	\$600.00
_____ GRI924-1/2	Pelvic Support Sm each support is 13" long	\$600.00
_____ GRI924-3/4	Pelvic Support Md each support is 15" long	\$600.00
_____ GRI924-5	Pelvic Support Lg each support is 18" long	\$600.00
_____ GR930	Ergonomic Harness Mn 9.5" - 15.5"	\$400.00
_____ GRI950-1/2	Ergonomic Harness Sm 12.5" - 18.5"	\$400.00
_____ GRI950-3/4	Ergonomic Harness Md 14.5" - 20.5"	\$400.00
_____ GRI950-5	Ergonomic Harness Lg 18.5" - 26.5"	\$400.00
_____ GR825	Chest Support Mn each support is 11.5" long	\$400.00
_____ GRI9511	Chest Support Sm each support is 13" long	\$400.00
_____ GRI9512	Chest Support Md each support is 15" long	\$400.00
_____ GRI9513	Chest Support Lg each support is 18" long	\$400.00

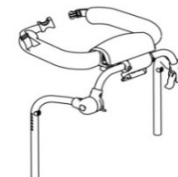
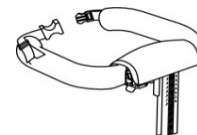
**Bars to attach HandleOptions Required**

Part Number	Description	Price (USD)
_____ GR835	Horizontal Bars Mn 6.5" long	\$145.00
_____ GRI835-1	Horizontal Bars Sm 8.5" long	\$150.00
_____ GRI835-3	Horizontal Bars Md, Lg 10.5" long	\$165.00

**Handle Options**

Part Number	Description	Price (USD)
_____ GR927	Posterior Hand Grips Mn requires GR835	\$50.00
_____ GR927-1/2	Posterior Hand Grips Sm, Md, Lg requires GR835-1, GR835-3	\$50.00
_____ GR926	Anterior Handle Bar Mn requires GRI-HW, GR835	\$100.00
_____ GRI845-1	Anterior Handle Bar Sm requires GRI-HW-1, GR835-1	\$100.00
_____ GRI845-3	Anterior Handle Bar Md requires GRI-HW-1, GR835-3	\$125.00
_____ GRI845-5	Anterior Handle Bar Lg requires GRI-HW-1, GR835-3	\$150.00
_____ GRI939	Ergonomic Handles Mn, Sm, Md, Lg requires GRI-HW, GR835	\$125.00
_____ GRI-HW	Multi Axis Hardware Mn	\$75.00
_____ GRI-HW-1	Multi Axis Hardware Sm, Md, Lg	\$75.00

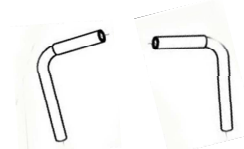
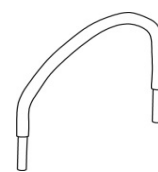
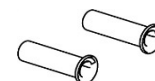

Arm Support Options

Part Number	Description	Price (USD)
GR809	Arm Supports Mn 7" long 4" wide requires GRI-HW, GR835	\$550.00
GRI809-1	Arm Supports Sm 6" long 4" wide requires GRI-HW-1, GR835-1	\$600.00
GRI809-3	Arm Supports Md 7.5" long 4.5" wide requires GRI-HW-1, GR835-3	\$650.00
GRI809-5	Arm Supports Lg 8" long 5" wide requires GRI-HW-1, GR835-5	\$700.00
<u>Description:</u> Works with Anterior and Posterior. Adjustable in height, direction, depth, tilt, and inclination.		
943	Arm Straps Mn, Sm (pair)	\$40.00
943-3	Arm Straps Md, Lg (pair)	\$40.00
32707	Elbow Stop Sm, Md, Lg 4"x3" padded elbow stop (pair)	\$385.00
50048	Elbow Stop Cover with Gel Insert (pair) requires 32707	\$250.00

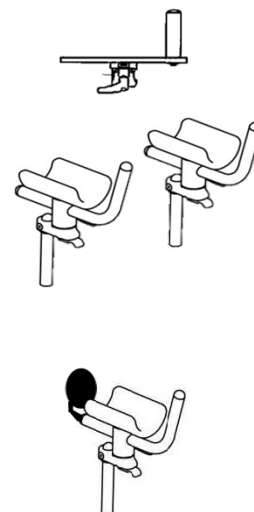

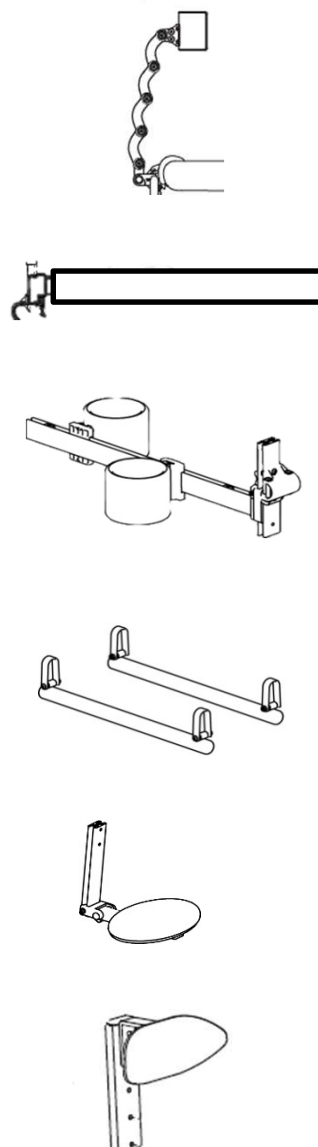

Accessories

Part Number	Description	Price (USD)
GRI865	Headrest Sm, Md, Lg POSTERIOR ONLY 10" height adjustment Requires Chest Support	\$550.00
GR890-0	Padded Leg Divider Mn 22" long	\$350.00
GRI890-1	Leg Divider Sm 21" long, cuff size 10" - 16"	\$650.00
GRI890-3	Leg Divider Md 23" long, cuff size 14" - 20"	\$700.00
GRI890-5	Leg Divider Lg 28" long, cuff size 18" - 26" <u>Description:</u> Adjustable in height and stride length.	\$750.00
GRI810-1	Weight Bars Sm 11.5 lbs. total	\$275.00
GRI810-3	Weight Bars Md, Lg 15 lbs. total	\$295.00
GR918-1	Folding Seat Sm POSTERIOR ONLY 10" deep, 6" wide	\$335.00
GR918-3	Folding Seat Md POSTERIOR ONLY 11" deep, 7" wide	\$365.00
GRI919-1	Lumbar Support Sm POSTERIOR ONLY 3" tall, 8" wide	\$280.00
GRI919-3	Lumbar Support Md POSTERIOR ONLY 4" tall, 9.5" wide	\$280.00

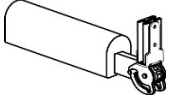
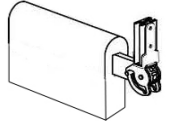

Accessories

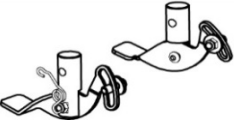
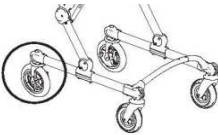
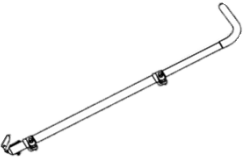
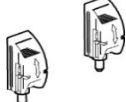
Part Number	Description	Price (USD)	
_____ GR815-1	Abduction Saddle Sm pad W: 2.5" H: 3.5" L: 9.5" Overall L: 14"	\$345.00	
_____ GR815-3	Abduction Saddle Md pad W: 3" H: 3.5" L: 9.5" Overall L: 14"	\$365.00	
_____ GR815-5	Abduction Saddle Lg pad W: 3" H: 4" L: 14" Overall L: 19" distance between pelvic harness and saddle top hole 4.5" bottom hole 6"	\$445.00	
_____ 34429	Saddle Extension Sm 6" of extended abduction requires GR815-1	\$175.00	
_____ 34430	Saddle Extension Md 6" of extended abduction requires GR815-3	\$185.00	
_____ 34431	Saddle Extension Lg 6" of extended abduction requires GR815-5	\$195.00	
_____ GR929-0	Pedal Parking Brakes Mn Comes attached to wheel	\$275.00	
_____ GR929	Pedal Parking Brakes Sm, Md, Lg	\$275.00	
_____ GR928-3/4	Narrow Rear Wheels Md with pedal brakes In-line wheel makes the over all width 27" instead of 30"	\$675.00	
_____ GR928-5	Narrow Rear Wheels Lg with pedal brakes In-line wheel makes the over all width 28.5" instead of 31.5" for Lg	\$675.00	
_____ GR923	Assistant Push Handle Mn, Sm, Md, Lg	\$290.00	
_____ GR-DL	Directional Locks Mn, Sm, Md, Lg	N/C	

Client Measurements

A Back height: _____ F Lower leg length: _____
 B Chest depth: _____ G Head height: _____
 C Chest width: _____ H Arm height: _____
 D Seat depth: _____ Age: _____
 E Seat width: _____ Weight: _____

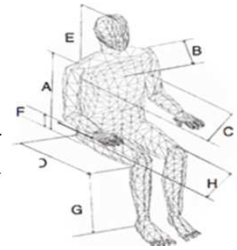

Dimensions

Measurements in Inches

Grillo	Mini	Small	Medium	Large
Max Capacity	77 lbs	99 lbs	198 lbs	242 lbs
User Height	29 - 39	35 - 53	43 - 65	59 - 75
Unit Weight	28 lbs	36 lbs	43 lbs	51 lbs
A	21 - 31	23.5 - 34	29 - 47	33 - 55
B	20 - 29.5	27 - 39	30 - 49	32 - 56
C	16.5 - 24	19 - 33	21 - 39	25 - 46
D	29	29.5	36	43.5
E	22.5	25.5	30	31.5

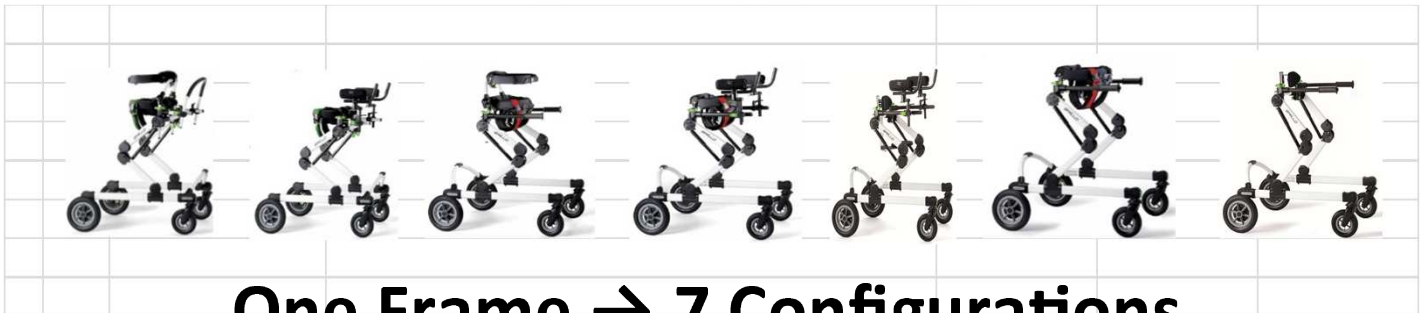
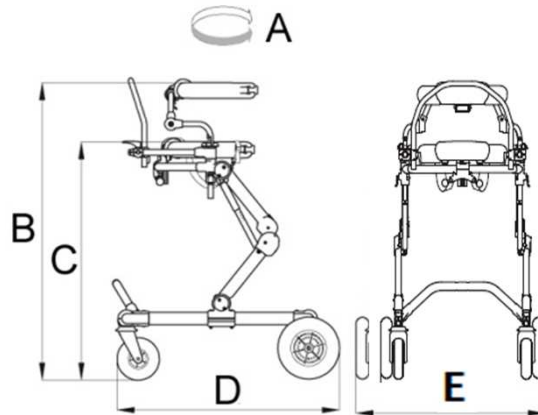

One Frame → 7 Configurations

Note: All specification and prices are subject to change without notice. Prices listed are only valid if ordering with a gait trainer. The HCPCS codes provided are not intended to be billing or legal advice, rather Innovation In Motion's interpretation of the code definitions. Use of the codes provided does not ensure coverage or payment for the item. For coverage information, verify the policy of the appropriate payer. It is recommended to contact Innovation In Motion with any questions regarding proper ordering of the chair at 1-260-665-2769.