

ADandD P/N PL-AB6

Mounting for Keyence LJ-V7020

Mounts with included (3) S.H.C.S. - M4-0.7mm X 8mm 18-8SS

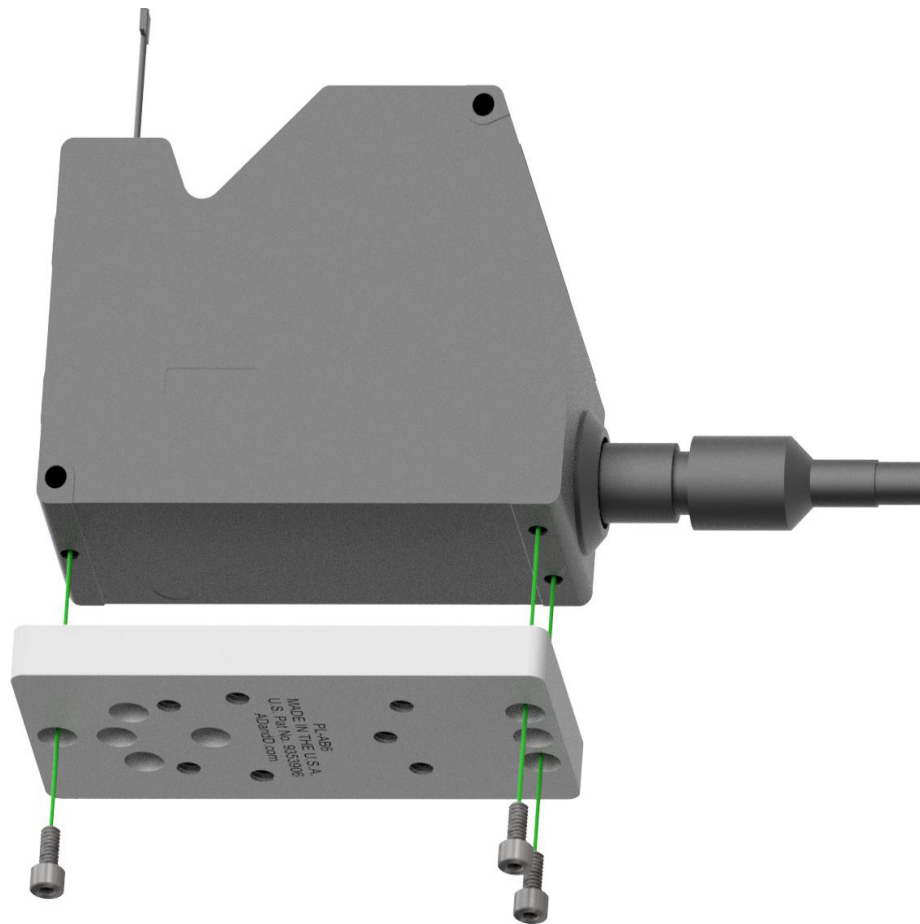

Sample Setup Application

