



By Ormesa



201 Growth Parkway Angola, IN 46703

Canadian Suggested Retail Price List in USD
Sep-19

Phone: 260-665-2769

Fax: 260-665-3047

Email: iim@mobility-usa.com

www.mobility-usa.com

Quote: _____

P.O. _____

Bill To

Dealer: _____ Contact: _____

Address: _____

City: _____ State: _____ Zip: _____

Phone: _____ Fax: _____

Email: _____ Mark For: _____

Ship To **Same as Bill To** _____

Dealer: _____ Contact: _____

Address: _____

City: _____ State: _____ Zip: _____

Phone: _____ Fax: _____

Email: _____ Mark For: _____

New Bug Features and Specifications

- **Seat** - can be used as a floor sitter, width and depth adjustable by 4" in each direction, small can be forward or reverse facing
- **Tilt** - incorporated in the seat 40°, easily adjusts with levers located on seat back
- **Headrest** - incorporated into the backrest so that the child always has a support
- **Backrest** - slightly contoured, can recline 35° (hinge coincides with child's center of gravity) height adjustable 4" with slots for accessories
- **Elevating Legrest** - push button adjustable, footrest is height and angle adjustable
- **Base** - black powder coated aluminum with an angle adjustable push-handle

New BUG Seat - includes: seat back, seat pan, tilt, and recline.

| Part Number | Description | Price (USD) | HCPCS |
|-------------|------------------------------------|-------------|-------|
| ____ NBS | New BUG Small | \$1,500.00 | E1399 |
| ____ NBS3 | New BUG Medium | \$1,600.00 | E1399 |
| ____ NBREC | Reclining Backrest required | \$400.00 | E1014 |



Outdoor Base Options

| Part Number | Description | Price | HCPCS |
|--------------|--|------------|-------|
| ____ NB869-1 | 4-Wheel Base Sm | \$1,900.00 | E1238 |
| ____ NB869-3 | 4-Wheel Base Md | \$2,000.00 | E1238 |
| ____ 891 | Set of Tie Down Hooks (Only available with NB869) | \$275.00 | K0108 |



Intended for forward-facing transport of the pushchair in a motor vehicle. Conforms with ISO 7176/19 and ANSI RESNA WC/19.









| | | | |
|--------------|-------------------------------|------------|-------|
| ____ NB856-1 | Hi-Low Feeding Base Sm | \$1,850.00 | E1399 |
| ____ NB856-3 | Hi-Low Feeding Base Md | \$1,950.00 | E1399 |
| ____ NB850-1 | Floor Base Sm | \$660.00 | E1399 |
| ____ NB850-3 | Floor Base Md | \$710.00 | E1399 |





Client:

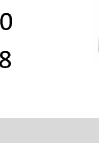

PO:

New Bug CAD













| Colors | | This price is only valid when purchasing a seat unit. | | | |
|---------------|---------------------------------------|---|--|---|---|
| Part Number | Description | Price | | | |
| NBLP-1/NBLP-3 | Light Grey with Pink and Teal accent | \$10.00 | |  |  |
| NBDP-1/NBDP-3 | Dark Grey with Pink and Teal accent | \$10.00 | |  |  |
| NBLG-1/NBLG-3 | Light Grey with Green and Teal accent | \$10.00 | |  |  |
| NBDG-1/NBDG-3 | Dark Grey with Green and Teal accent | \$10.00 | |  |  |

| Footrest Options | | Footplate and Hardware Required Parts | | |
|------------------|---|---------------------------------------|-------|---|
| Part Number | Description | Price (USD) | HCPCS | |
| NB810-1 | Angle Adjustable Flip Up Footplate Sm requires NB810-HW | \$125.00 | K0040 |  |
| NB810-3 | Angle Adjustable Flip Up Footplate Md requires NB810-HW | \$125.00 | K0040 | |
| NB810-HW | Footplate Hardware and Adjustment Tool | \$125.00 | E1028 | |







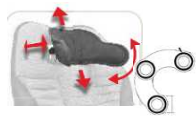



| Footrest Accessories | | | | |
|----------------------|----------------------|-------------|-------|---|
| Part Number | Description | Price (USD) | HCPCS | |
| NB811 | Calf Strap | \$50.00 | E0995 |  |
| 827 | Foot Strap 8-11" | \$70.00 | E0951 |  |
| 827A | Foot Strap 11-14" | \$80.00 | E0951 | |
| NB892-1/2 | Padded Foot Plate Sm | \$100.00 | K0108 |  |
| NB892-3/4 | Padded Foot Plate Md | \$100.00 | K0108 | |

| Hip Guide Options | | Hip Guides and Hardware Required Parts | | |
|--------------------|---|--|-------|---|
| Part Number | Description | Price (USD) | HCPCS | |
| <u>Size Small</u> | | | | |
| NB815-L-1 | Left Hip Guide width & angle adj armrest & upholstery requires NB815-HW | \$60.00 | E0956 |  |
| NB815-R-1 | Right Hip Guide width & angle adj armrest & upholstery requires NB815-HW | \$60.00 | E0956 | |
| NB815-L-HW/R-HW | Hardware for Hip Guide and Arm Rest | \$60.00 | E1028 | |
| <u>Size Medium</u> | | | | |
| NB815-L-3 | Left Hip Guide width & angle adj armrest & upholstery requires NB815-HW | \$60.00 | E0956 |  |
| NB815-R-3 | Right Hip Guide width & angle adj armrest & upholstery requires NB815-HW | \$60.00 | E0956 | |
| NB815-L-HW/R-HW | Hardware for Hip Guide and Arm Rest | \$60.00 | E1028 | |

Positioning Options

| Part Number | Description | Price (USD) | HCP | CS | |
|--------------|---|-------------|-------|----|---|
| 817-1 | Leg Straps Sm | \$135.00 | K0038 | |  |
| 817-3 | Leg Straps Md | \$135.00 | K0038 | | |
| NB920-1/2 | 4 Point Pelvic Belt Sm | \$195.00 | E0978 | |  |
| NB920-3/4 | 4 Point Pelvic Belt Md | \$195.00 | E0978 | | |
| 894-1 | 45° Pelvic Belt Sm | \$95.00 | E0978 | |  |
| 894-3 | 45° Pelvic Belt Md | \$95.00 | E0978 | | |
| 906-1 | 5 Point Harness Sm | \$130.00 | E0960 | |  |
| 906-4 | 5 Point Harness Md | \$130.00 | E0960 | | |
| NB903-1 | 5 Point Vest Harness Sm | \$295.00 | E0960 | |  |
| NB903-3 | 5 Point Vest Harness Md | \$295.00 | E0960 | | |
| 853 | Vest Harness Sm | \$175.00 | E0960 | |  |
| 853-3 | Vest Harness Md | \$175.00 | E0960 | | |
| NB868-1 | Wrappable and Flexible Trunk Supports Sm height and depth adjustable | \$430.00 | E0956 | |  |
| NB868-3 | Wrappable and Flexible Truck Supports Md height and depth adjustable | \$430.00 | E0956 | | |
| HB435-S32-B1 | Body Point X Small 4 Point Hip Belt WC19 Compliant - size 9" - 11" | \$140.00 | E0978 | |  |
| SH260XS-B1 | Body Point X Small Pivot Fit Shoulder Harness WC19 Compliant - size 9" - 11" | \$175.00 | E0960 | |  |
| NB838-1 | Lateral Pads Sm <small>requires NB838-HW</small> | \$100.00 | E0956 | |  |
| NB838-3 | Lateral Pads Md <small>requires NB838-HW</small> | \$100.00 | E0956 | | |
| NB838-HW | Lateral Hardware height and depth adjustable | \$150.00 | E1028 | | |
| NB834-1 | Padded Abduction Block with Hardware Sm depth adjustable | \$140.00 | E0957 | |  |
| NB834-3 | Padded Abduction Block with Hardware Md depth adjustable | \$140.00 | E0957 | | |
| NB852-1 | Headrest w/ Parietal Supports Sm fixed, height adjustable | \$290.00 | E0955 | |  |
| NB852-3 | Headrest w/ Parietal Supports Md fixed, height adjustable | \$290.00 | E0955 | | |
| NB863-1 | Headrest w/ Occipital-Parietal Supports Sm <small>requires NB863-HW</small> | \$290.00 | E0955 | |  |
| NB863-3 | Headrest w/ Occipital-Parietal Supports Md <small>requires NB863-HW</small> | \$290.00 | E0955 | | |
| NB863-HW | Multi Axis Hardware - angle and depth adjustable | \$265.00 | E1028 | | |
| NB942-1 | Ergonomic Headrest Sm <small>requires NB942-HW</small> | \$290.00 | E0955 | |  |
| NB942-3 | Ergonomic Headrest Md <small>requires NB942-HW</small> | \$290.00 | E0955 | | |
| NB942-HW | Multi Axis Hardware - angle and depth adjustable | \$170.00 | E1028 | | |

Accessories

| Part Number | Description | Price (USD) | HCPCS | |
|-------------|---|-------------|-------|---|
| NB819-1 | Black Retractable Canopy Sm front and rear view window requires NB819-HW | \$295.00 | K0108 |  |
| NB819-3 | Black Retractable Canopy Md front and rear view window requires NB819-HW | \$295.00 | K0108 | |
| NB819-HW | Canopy Hardware | \$95.00 | E1028 | |
| NB825-1 | Black Rain Cover Sm requires NB819 | \$140.00 | K0108 |  |
| NB825-3 | Black Rain Cover Md requires NB819 | \$140.00 | K0108 | |
| NB824-1 | Transparent Table with Edge & Hollow Sm requires NB824-HW | \$240.00 | E0950 |  |
| NB824-3 | Transparent Table with Edge & Hollow Md requires NB824-HW | \$240.00 | E0950 | |
| NB824-HW | Adjustable and Removable Table Hardware | \$100.00 | E1028 | |
| NB839-1 | Front Handle Sm | \$200.00 | K0108 |  |
| NB839-3 | Front Handle Md | \$200.00 | K0108 | |
| 818 | Black Thermal Cover Sm | \$365.00 | K0108 |  |
| 818-3 | Black Thermal Cover Md | \$365.00 | K0108 | |
| 858 | Medical Necessity Basket Sm Not compatible with NB927 or NB935 | \$125.00 | K0108 |  |
| 858-3 | Medical Necessity Basket Md Not compatible with NB927 or NB935 | \$125.00 | K0108 | |
| NB927-1 | Vent Tray Sm Not compatible with 858 | \$650.00 | E1029 |  |
| NB927-3 | Vent Tray Md Not compatible with 858 | \$650.00 | E1029 | |
| 922 | Water Bottle Holder | \$45.00 | K0108 |  |
| NB935 | Oxygen Bottle Holder Sm Not compatible with 858 | \$250.00 | E2208 |  |
| NB935-3 | Oxygen Bottle Holder Md Not compatible with 858 | \$250.00 | E2208 | |
| NB-IV | IV Pole | \$495.00 | K0108 |  |

Client Measurements:

A Back height: _____ F Lower leg length: _____
 B Chest depth: _____ G Head height: _____
 C Chest width: _____ H Arm height: _____
 D Seat depth: _____ Age: _____
 E Seat width: _____ Weight: _____

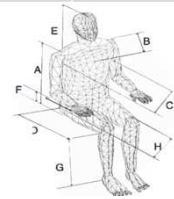

DIMENSIONS

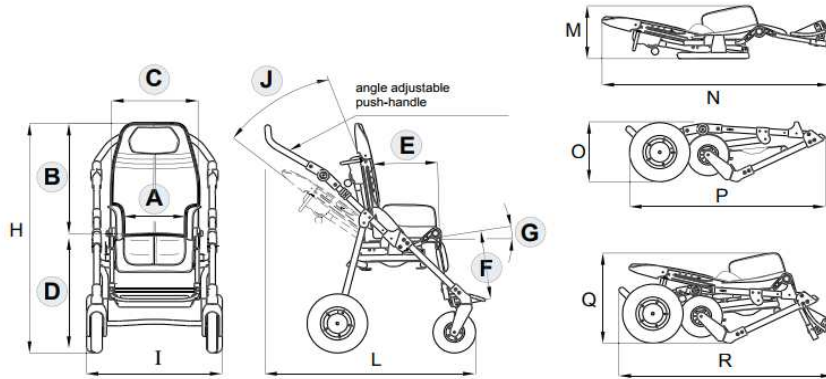

Measurements in Inches

| Seat & Bases | MAX LOAD | A | B | C | D | E | F | G | J | H | I | L | M | N | O | P | Q | R | FRAME WEIGHT | SEAT WEIGHT | TOTAL WEIGHT |
|---------------|----------|---------|---------|------|-----------|---------|---------|----------|-----|---------|------|---------|------|------|------|-----|------|-----|--------------|-------------|--------------|
| Sm 4 wheel | 77 lbs | 8 - 11 | 20 - 24 | 14.5 | 20.5 | 8 - 12 | 5 - 12 | 0° - 35° | 35° | 41 - 45 | 22.5 | 26 - 37 | 11.5 | 34.5 | 11.5 | 32 | 17 | 32 | 21 | 19 | 40 |
| Md 4 wheel | 99 lbs | 10 - 14 | 24 - 30 | 17 | 21.5 | 12 - 16 | 12 - 16 | 0° - 25° | 40° | 45 - 51 | 24.5 | 32 - 42 | 13.5 | 44 | 14 | 36 | 20.5 | 37 | 23 | 25 | 48 |
| Sm 3 wheel | 77 lbs | 8 - 11 | 20 - 24 | 14.5 | 20.5 | 8 - 12 | 5 - 12 | 0° - 35° | 35° | 41 - 45 | 22.5 | 26 - 37 | 11.5 | 34.5 | 16 | 31 | N/A | N/A | 23 | 19 | 42 |
| Md 3 wheel | 99 lbs | 10 - 14 | 24 - 30 | 17 | 21.5 | 12 - 16 | 12 - 16 | 0° - 25° | 40° | 45 - 51 | 24.5 | 32 - 42 | 13.5 | 44 | 16 | 38 | N/A | N/A | 25 | 25 | 50 |
| Sm Hi/Low | 77 lbs | 8 - 11 | 20 - 24 | 14.5 | 18.5 - 29 | 8 - 12 | 5 - 12 | 0° - 35° | 35° | 39 - 53 | 22 | 14 - 24 | 31 | 16 | 9 | N/A | N/A | N/A | 32 | 19 | 51 |
| Md Hi/Low | 99 lbs | 10 - 14 | 24 - 30 | 17 | 18.5 - 29 | 12 - 16 | 12 - 16 | 0° - 25° | 40° | 42 - 58 | 24 | 14 - 24 | 33 | 18 | 13 | N/A | N/A | N/A | 34 | 25 | 59 |
| Sm floor base | 77 lbs | 8 - 11 | 20 - 24 | 14.5 | 6.5 | 8 - 12 | 5 - 12 | 0° - 35° | 35° | 27 - 31 | 18 | 2.5 | 24 | 16 | 9 | N/A | N/A | N/A | 10 | 19 | 29 |
| Md floor base | 99 lbs | 10 - 14 | 24 - 30 | 17 | 6.5 | 12 - 16 | 12 - 16 | 0° - 25° | 40° | 30 - 36 | 20 | 2.5 | 25 | 18 | 11 | N/A | N/A | N/A | 12 | 25 | 37 |

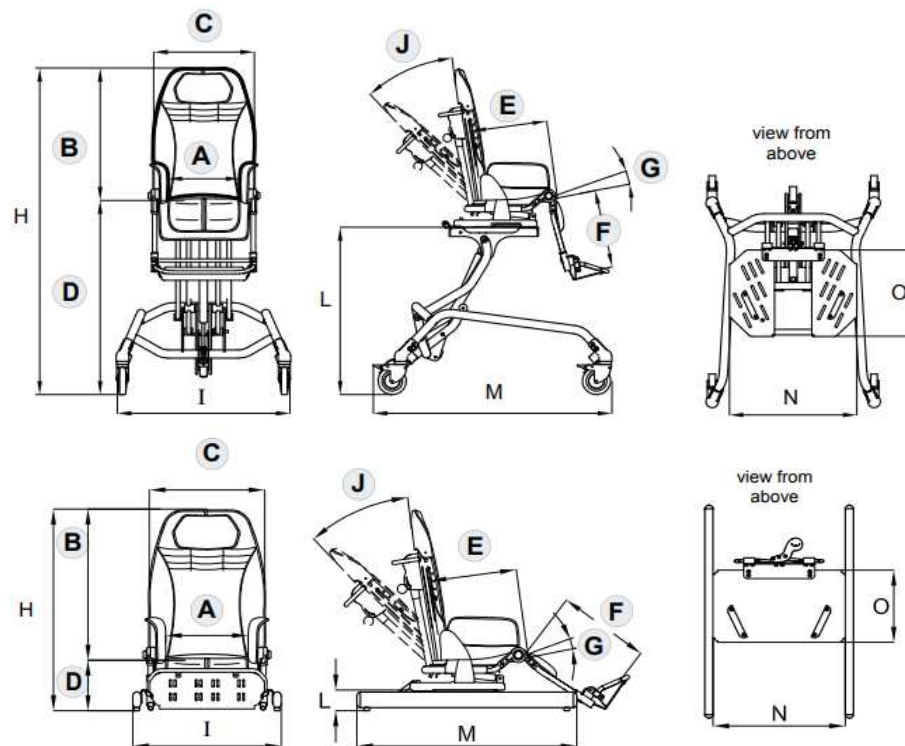

Note: All specification and prices are subject to change without notice. Prices listed are only valid if ordering with a base. The HCPCS codes provided are not intended to be billing or legal advice, rather Innovation In Motion's interpretation of the code definitions. Use of the codes provided does not ensure coverage or payment for the item. For coverage information, verify the policy of the appropriate payer. It is recommended to contact Innovation In Motion with any questions regarding proper ordering of the chair at 1-260-665-2769.