

ISSN: 2467-4885

# Asian Intellect

FOR ACADEMIC ORGANIZATION AND DEVELOPMENT INC.

VOLUME 1 NO. 1

OCTOBER 2015

---

**RESEARCH and EDUCATION JOURNAL**

---





 **Asian Intellect**  
FOR ACADEMIC ORGANIZATION AND DEVELOPMENT INC.

**RESEARCH  
AND  
EDUCATION  
JOURNAL**

**VOLUME 1, No. 1, OCTOBER 2015**

## **Editorial Board**

**RODNEY P. DAVIS, Ph.D.**

Troy University  
**Editor-in-Chief**

**MURPHY P. MOHAMMED, Ed.D.**

**Editorial Consultant**

**JULIE LIEZEL C. FERRER, MDA**

**Issue Editor**

**JENECY MARZEL C. FERRER**

**Managing Editor**

**MELVIN REN ADDUN**

**Circulation**

**JOAN MARION ADDUN**

**Cover Design**

## **Publication Guidelines**

1. All articles must be authorized for publication by the author/s.
2. All the research papers published must have a high degree of scholarship.
- 3 All the research papers published must be approved by the editorial board .
4. All the research papers published must have undergone evaluation from our corps of referees thru double-blind referee process.
5. The articles may either be written in English or Filipino. All articles written in either languages must be accompanied by an Abstract which is written in English.
6. All contributions must be original.

# TABLE of CONTENTS

Impact of ASEAN Integration to the Students of North Luzon Philippines State College <i>By: Dr. Severino G. Alviento</i>	<i>page 7</i>
Employment Status of Accountancy and Business Graduates at Catanduanes State University <i>By: Lily P. Custodio, Ph.D. and Melinda V. Abichuela</i>	<i>page 15</i>
Stakeholders' Assessment of an Institution's Underlying Principle <i>By: Lily Pantino Custodio</i>	<i>page 21</i>
Magic Realism in Hiligaynon Urban Legends <i>By: Ruth Garcia Tribunal</i>	<i>page 27</i>
Performance of ROTC Cadets during the Annual Administrative and Tactical Inspection (RAATI): Basis For Instructional Manual <i>By: Juliet S. Trujillo</i>	<i>page 36</i>
The MTB-MLE in the Field Of Instruction: Snapshot Observations and Review of Practices <i>By: Andres T. Malinnag, Jr. Ed.D.</i>	<i>page 41</i>
Low Voltage and High Efficiency DC-DC Boost Converter Design for Heat Waste Thermal to Electrical Energy Conversion <i>By: Engr. Gillert M. Bongcac, MoE</i>	<i>page 48</i>
Maximum Potential Energy Produced Through Heat Dissipation of the Microprocessor Heatsink <i>By: Engr. Gillert M. Bongcac, MoE</i>	<i>page 56</i>
Financial Performance of Catanduanes State University Multi-Purpose Cooperative Microfinancing Services: A Case Study <i>By: Maria Isabel L. de la Hostria, MBA</i>	<i>page 61</i>
Optimal Low Power CMOS OPAMP Design for an Alternative Power Source <i>By: Engr. Gillert M. Bongcac, MoE</i>	<i>page 70</i>

The *Asian Intellect Research and Education Journal*  
is a refereed journal and is published semi-annually by the



with  
SEC REGISTRATION NO. CN201539886  
and office address at  
BLOCK 33B, LOT 1, PHASE 2, KAUNLARAN VILLAGE, NAVOTAS CITY  
and  
SAN RAFAEL, TARLAC CITY

EMAIL: [asianintellectorg@gmail.com](mailto:asianintellectorg@gmail.com) WEBSITE: [www.asianintellect.org](http://www.asianintellect.org)

# IMPACT OF ASEAN INTEGRATION TO THE STUDENTS OF NORTH LUZON PHILIPPINES STATE COLLEGE

**Dr. Severino G. Alviento**

*OIC, Office of the President*

North Luzon Philippines State College  
San Nicolas, Candon City, Ilocos Sur

## ABSTRACT

*This study aims to determine the perceived impact of the ASEAN Integration to the students of North Luzon Philippines State College. The respondents of this study are the AB Political Science and the Teacher Education students of NLPSC.*

*The researcher employed the descriptive-survey and correlational method of research in this study. The questionnaire was the primary tool used in gathering the data needed which was analyzed using the frequency counts and percentages, weighted mean and Pearson product method of correlation. The researcher formulated the questionnaire which elucidated the necessary information to the research.*

*The researcher made the following findings and conclusion: The AB Political Science student-respondents agree that ASEAN Integration gives opportunities to the Higher Education Institutions in the country while the Teacher Education student-respondents strongly agree that ASEAN Integration would have an impact to the Higher Education institutions in the country. Based from the findings and conclusions, the researcher recommended that Higher Education Institutions should enhance the quality of education and upgrade to international standards to the greatest advantage without restricting academic freedom and institutional mandates.*

Keywords: Integration, Education, Impact, collaboration, Internalization

## INTRODUCTION

By the end of December 2015, ASEAN Member States, including the Philippines, will integrate into a single market and production base, realizing the vision of an ASEAN Economic Community (AEC). The objective is to have a competitive market by turning ASEAN into a single market and production base. There will be a free flow of goods, services and investment capital among the member countries, e.g., tariff on most goods will be reduced, certain customs procedures will be streamlined, among others.

According to the Commission on Higher Education (CHED), the reality of an ASEAN community which will facilitate the free flow of qualified labor in the region will either open up opportunities for graduates of Philippine Higher Education Institutions or threaten their employment even in their own country.

Meanwhile, the K to 12 curriculum of the Department of Education (DepEd) said that the

preparation for ASEAN Integration and an initiative to ensure that the Philippine education would be at par with other countries in terms of quality. In the implementation of ASEAN Integration, the travel of students would be cheaper and will pave more access to education by trying to eliminate barriers through physical travel. Anent to this inevitable scenario, the Philippine education should also be ready in accommodating students, especially the curriculum. ([www.mb.com.ph/deped-playing-catch-up-for-asean-2015](http://www.mb.com.ph/deped-playing-catch-up-for-asean-2015))

The Thai Higher Education Review meanwhile stressed that although the ASEAN Community is based on three pillars, education appears to be a cross cutting element that support a successful and stable formation of the ASEAN Community. According to the ASEAN Charter, a closer cooperation in education and human resource development will empower the people of ASEAN and strengthen the ASEAN Community.

Based from the findings of the research

study conducted by Alviento and Alviento (2014), the research leaders in region 1, 2 and CAR are optimistic on the role of research in the ASEAN Integration especially on the competitiveness of higher education in accordance with international standard. Also, there is a perceived wide opportunity for the Higher Education Institutions (HEIs) along Research and Development in ASEAN Integration.

On the economic effect, there are those who expressed concern that the country is ill-prepared to meet the looming stiff competition from their ASEAN counterparts. According to them, some leading domestic banks, though well-capitalized, will be easily dwarfed if larger commercial banks enter the country. Also, automobile assemblers cite smuggling and the continuous entry of second-hand cars as contributors to their vulnerability compared to their peers in Malaysia and Thailand. Exporters of agricultural and manufactured goods highlight lack of access to finance and technology as bottlenecks to their competitiveness.

As suggested by Senators Sonny Angara and Bam Aquino, legislation may be necessary to institutionalize the necessary regulatory changes, but concerted effort must also come from the executive as well as the private sector if the Philippines is to benefit at all from the upcoming regional integration. With regard to this matter, the two senators filed a resolution calling on the Senate Committee on Trade and Commerce to conduct an inquiry into the opportunities and threats the looming integration poses on the country.

This study aims to determine the perceived impact of the ASEAN Integration to the students of North Luzon Philippines State College. The respondents of this study are 35 AB Political Science and 35 3<sup>rd</sup> and 4<sup>th</sup> Year Teacher Education students major in Social science.

### **Statement of the Problem**

This study aims to determine the impact of the ASEAN Integration to the students of North Luzon Philippines State College.

Specifically, it sought to find an answer to the following questions:

1. What is the profile of the respondents in terms of sex, religion, average monthly allowance, kind of scholarship privilege, and place of residence?
2. What is the level of impact of the ASEAN

Integration to the AB Political Science and Teacher Education student-respondents of North Luzon Philippines State College?

3. Is there a significant relationship between the profile of the AB Political Science and Teacher Education student-respondents of North Luzon Philippines State College and level of impact of ASEAN Integration?
4. Is there a significant difference between the perceptions of AB Political Science and Teacher Education student-respondents of North Luzon Philippines State College on the impact of ASEAN Integration?

## **METHODOLOGY**

The researchers made use of a descriptive correlational method of research/ study.

### ***Statistical Treatment of Data***

The following statistical tools were used to treat the data:

**Frequency Count and Percentage.** This is the statistical tool used to describe the profile of the respondents.

**Weighted Mean.** This is the statistical tool used to determine the impact of ASEAN integration to the AB Political Science and Teacher education student-respondents of North Luzon Philippines State College.

**Pearson Product Moment of Correlation.** This was used to determine the relationship between the profile of the respondents and the impact of ASEAN integration to them.

**Statistical Package for Social Sciences (SPSS).** This refers to the statistical software for data analysis.

To describe the quantitative evaluation on the impact of perception of ASEAN integration to the AB Political Science and Teacher Education students of North Luzon Philippines State college, the following range was used:

**Data Gathering Procedure.** The researcher floated the questionnaire with the help of some of his students who served as data collectors.

The floating of the questionnaire was done in a room to room basis. The questionnaires were retrieved after the respondents had accomplished the said instrument. After gathering all the questionnaires, tallying, coding and interpretation of data were done.

**Weighted Mean** was used to determine the perception of student-respondents on the level



of impact of the ASEAN Integration to the students of North Luzon Philippines State College.

### FINDINGS

Rating	Quantitative	Descriptive Rating
5	4.21 – 5.00	Strongly Agree (SA)
4	3.41 – 4.20	Agree (A)
3	2.61 – 3.40	Uncertain (U)
2	1.81 – 2.60	Disagree (D)
1	1.00 - 1.80	Strongly Disagree (SD)

#### 1. Profile of the respondents:

##### AB Political Science student-respondents

There is only one or 2.86 percent who belong to the age bracket of 19-20 years old, 20 or 57.14 percent to 21-22 years old, nine or 25.71 percent to 23-24 years old, and five or 14.29 percent are 25 years old or older.

There are 16 or 45.71 male and 19 or 54.29 percent are female.

There are three or 8.57 percent have an average monthly allowance of less than 1,000.00, 12 or 34.29 percent have P 1,000.00 – P 2,999.99 and 20 or 57.14 percent have Php 3,000.00 – Php 4,999.99 average monthly allowance

Along scholarship privilege, there are two

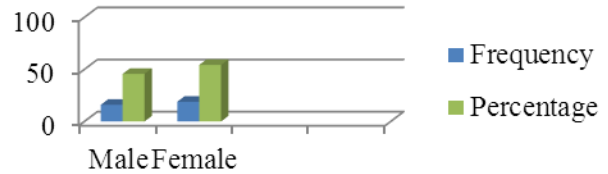

or 5.71 percent who are Congressional scholar, six or 17.14 are Candon City scholar, one or 2.86

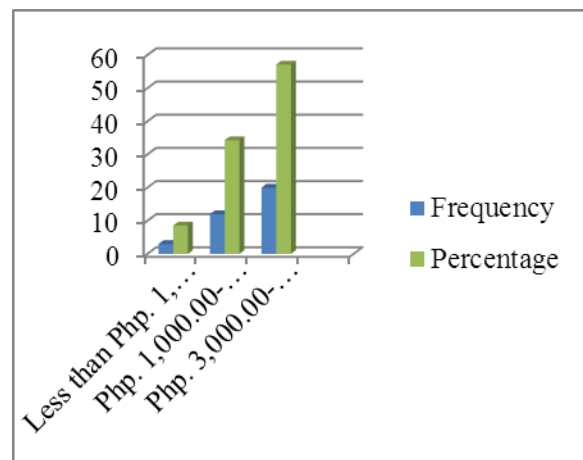

percent is a student government scholar and 26 or 74.29 percent have no scholarship privilege.

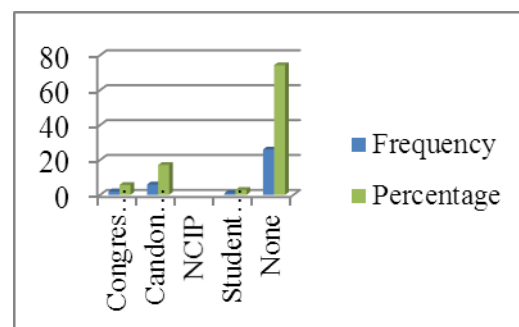
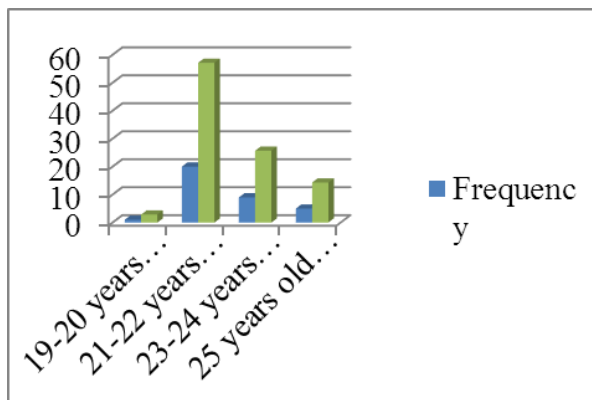

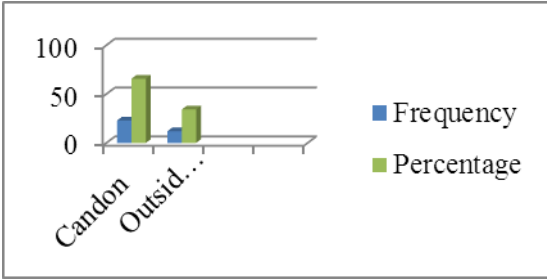

There are 11 or 31.43 percent who have an average monthly allowance of less than Php 1,000.00, 15 or 42.86 percent have Php 1,000.00 – Php 2,999.99 and eight or 25.71 percent have a Php 3,000.00 – Php 4,999.99 average monthly allowance.

There are 23 or 65.71 percent who are residence of Candon City, 12 or 34.29 percent are residents outside Candon City.

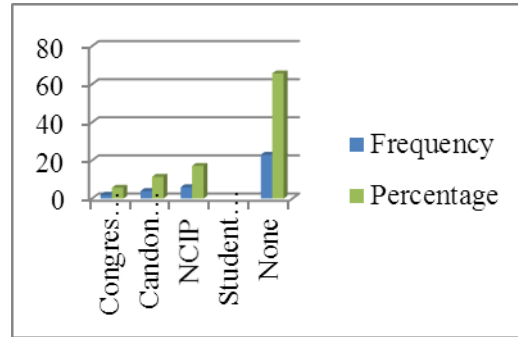

**Teacher Education student-respondents**

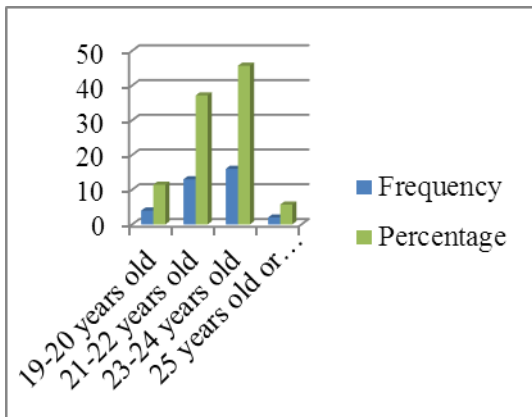

There are four or 11.43 percent who belong to the age bracket of 11.43 percent, 13 or 37.14 percent to 21-22 years old, 16 or 45.71 percent and two or 5.71 percent.

There are two or 5.71 percent are Congressional scholars, four or 11.43 percent are Candon City scholars, six or 17.14 percent are NCIP scholars, and 23 or 65.71 percent have no scholarship privileges.

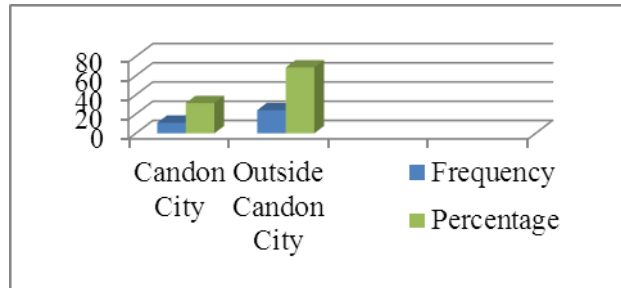

There or 8.57 percent are male and 32 or 91.43 percent are female.

There are 11 or 31.43 percent who are residents of Candon City and 24 or 68.57 percent are residents outside Candon City.

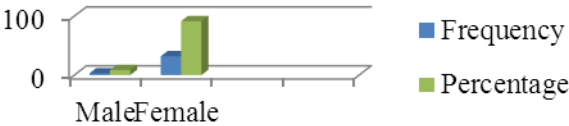

91.43 percent are female.

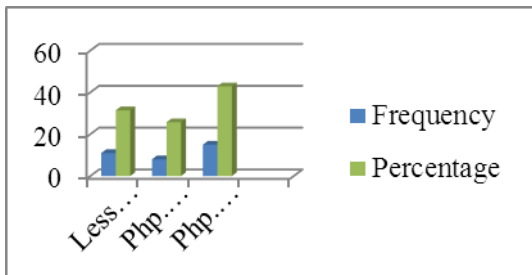

**2. Level of impact of the ASEAN Integration to the respondents**

Perceived Impact of ASEAN Integration to the NLPSC Students	AB Pol Sci Students		Teacher Education Students	
	$\bar{x}$	DL	$\bar{x}$	DL
<i>The ASEAN Integration would be an opportunity to.....</i>				

Perceived Impact of ASEAN Integration to the NLPSC Students	AB Pol Sci Students		Teacher Education Students	
harmonize the programs and activities of universities and colleges among ASEAN nations	4.06	A	4.70	SA
promote educational cooperation to narrow the development gaps in the ASEAN region	4.03	A	4.52	SA
prepare the students of HEIs for regional leadership	4.11	A	4.55	SA
upgrade the curricula of HEIs to meet shifting labor demand	4.09	A	4.45	SA
promote better student and professional training	4.34	SA	4.73	SA
upgrade quality of public higher education to international standards	4.26	SA	4.70	SA
responsive to development thrusts without neglecting local needs	4.00	A	4.39	SA
enhance the curricula in the HEIs' objective as an instrument of poverty alleviation	3.86	A	4.33	SA
students' access to a variety of programs and courses in other countries	4.20	A	4.67	
better employment and career opportunities of graduates	4.40	SA	4.85	SA

exchange scholarship programs	4.23	SA	4.64	SA
enhance the knowledge of students on the best practices of HEIs of ASEAN members	4.34	SA	4.73	SA
enhance the capabilities of the students to conduct research that is contributory to transformative education	4.23	SA	4.64	SA
provide better opportunity for information necessary for the continuous dev't of the higher education institutions' competencies	4.37	SA	4.64	SA
enhance general academic effectiveness of the students in the HEIs	4.06	A	4.48	SA
increase the enrolment of the Higher Education Institutions	3.74	A	4.19	A
minimize dropout in the HEIs	4.03	A	4.15	A
expand schools in remote areas in the country	3.91	A	4.67	SA
improve technical and vocational education and training	4.00	A	4.97	SA
reform the curricula to be demand-driven	3.80	A	4.76	SA
<b>MEAN</b>	<b>4.10</b>	<b>A</b>	<b>4.59</b>	<b>SA</b>

The AB Political Science student-respondents generally agree that ASEAN Integration would have an impact to the HEIs in the country ( $\bar{x}$  = 4.10).

**They agree that there will be:**

- ▶ harmonization of programs and activities of the Universities and colleges among ASEAN Members-nations ( $\bar{x}$  = 4.06),

- ▶ promotion of educational cooperation to narrow the development gaps in the ASEAN region ( $\bar{x}$  = 4.03),

- ▶ more prepared students of HEIs for regional leadership ( $\bar{x}$  =4.11),
- ▶ an upgraded curricula of HEIs to meet shifting labor demand ( $\bar{x}$  = 4.09),
- ▶ responsive HEIs to development thrusts without neglecting local needs ( $\bar{x}$  =4.00), and
- ▶ enhanced curricula in the HEIs' objective as an instrument of poverty alleviation ( $\bar{x}$  =3.86),
- ▶ an opportunity for the students' access to a variety of programs and courses in other countries ( $\bar{x}$  = 4.20),
- ▶ enhanced general academic effectiveness of the students in the HEIs ( $\bar{x}$  =4.06),
- ▶ increase the enrolment of the Higher Education Institutions in the country ( $\bar{x}$  =3.74),
- ▶ minimize dropouts in the universities and colleges ( $\bar{x}$  =4.03),
- ▶ an expansion of schools in the remote areas ( $\bar{x}$  =3.91),
- ▶ improvement of technical and vocational education and training ( $\bar{x}$  =4.00) and
- ▶ reform in the curricula to be demand-driven ( $\bar{x}$  =3.80).

**They strongly agree that there will be:**

- ▶ promotion of better student and professional training during the ASEAN Integration ( $\bar{x}$  =4.34),
- ▶ an upgraded quality of public higher education to international standards ( $\bar{x}$  = 4.26),
- ▶ a better employment and career opportunities of graduates ( $\bar{x}$  =4.40),
- ▶ exchange of scholarship programs ( $\bar{x}$  =4.23),
- ▶ enhanced knowledge of students on the best practices higher education institutions in the universities of ASEAN members ( $\bar{x}$  =4.34),
- ▶ enhanced capabilities of the students to conduct research contributory to transformative education in the ASEAN ( $\bar{x}$  =4.23),
- ▶ better opportunity for information necessary for the continuous development of the higher education institutions' competencies ( $\bar{x}$  =4.37).

The Teacher Education student-respondents strongly agree that ASEAN Integration would have an impact to the HEIs in the country ( $\bar{x}$  =4.59).

**They strongly agree that there will be:**

- ▶ harmonized programs and activities of the HEIs ( $\bar{x}$  =4.70),
- ▶ promotion of educational cooperation to narrow the development gaps in the ASEAN region ( $\bar{x}$  =4.52),
- ▶ more prepared students for regional leadership ( $\bar{x}$  =4.55),
- ▶ upgraded curricula to meet shifting labor demand ( $\bar{x}$  =4.45),
- ▶ promotion of better student and professional training ( $\bar{x}$  =4.73)
- ▶ upgraded quality education to international standards ( $\bar{x}$  =4.70)
- ▶ responsive to development thrusts ( $\bar{x}$  =4.39),
- ▶ enhanced curricula that will be an instrument of poverty alleviation ( $\bar{x}$  =4.33),
- ▶ more students to access the variety of programs and courses in other countries ( $\bar{x}$  =4.67),
- ▶ better employment and career opportunities of graduates ( $\bar{x}$  =4.85),
- ▶ exchange scholarship programs ( $\bar{x}$  =4.64),
- ▶ enhanced knowledge of students on the best practices of HEIs of ASEAN member-nations ( $\bar{x}$  =4.73),
- ▶ enhanced capabilities of the students to conduct research contributory to transformative education in the ASEAN ( $\bar{x}$  =4.64),
- ▶ better opportunity for information necessary for the continuous development of HEIs' competencies ( $\bar{x}$  =4.64),
- ▶ enhanced general academic effectiveness of the students of the HEIs ( $\bar{x}$  =4.48),
- ▶ expansion of schools in remote areas in the country ( $\bar{x}$  =4.67),
- ▶ improved technical and vocational education and training ( $\bar{x}$  =4.97),
- ▶ a reformed curricula to be demand-driven ( $\bar{x}$  =4.76).

**They agree that there would be:**

- ▶ increase of enrolment in the HEIs in the country ( $\bar{x}$  =4.19) and
- ▶ minimize dropout in the Higher Education Institutions ( $\bar{x}$  =4.15).

**3. Significant relationship between the profile of the respondents and level of perceived impact of ASEAN Integration.**

There is no significant relationship on the

profile of the AB Political Science student-respondents with their perception on the impact of ASEAN integration.

Those who have bigger average monthly allowance Teacher Education student-respondents have a high level of perception on the impact on the ASEAN Integration. Other profile of the said

**AB Political Science student-respondents**

Profile	$r_{xy}$	$p$
Age	-.040	.820
Sex	.109	.533
Allowance	.282	.100
Scholarship	.060	.733
Residence	.022	.899

respondents are not significantly related with their perception on the impact of the ASEAN integration.

**Teacher Education student-respondents**

Profile	$r_{xy}$	$p$
Age	-.035	.845
Sex	.061	.735
Allowance	.533**	.001
Scholarship	.058	.748
Residence	-.135	.455

**4. Significant difference between the perceptions of the respondents on the impact of ASEAN Integration.**

Difference between the perception AB Political Science and Teacher Education student-respondents

There is a significant difference on the level of perception of the AB Political Science and Teacher Education respondents on the impact

of ASEAN integration. Teacher Education student-respondents have a higher level of perception since ( $\bar{x}$ ) mean is 4.59 while AB Political Science student-respondents have 4.10.

**CONCLUSION**

The researcher made the following conclusion based from the findings of the study.

Group	Mean	Sd	Mean Diff.	t	df	Sig.	Decision
AB	4.10	.191	.485	-10.537	19	.000	H <sub>0</sub> rejected
Teacher Ed.	4.59	.208					

1. Majority of the AB political Science student-respondents belong to the age bracket of 21-22 years old while less than majority of the Teacher Education Student-respondents belong to the age bracket of 23-24 year old.

2. Majority of the respondents are female and have no scholarship privileges.

3. Majority of the AB Political Science students and less than majority of the teacher education students have an average monthly allowance of Php 3,000.00 – Php 4,999.99.

4. Majority of AB Political Science students are residents of Candon City while the Teacher Education student-respondents are residents outside Candon City.

5. The AB Political Science student-respondents agree that ASEAN Integration is an opportunity to the Higher Education institutions in the country with the computed mean value of 4.10.

6. The Teacher Education student-respondents strongly agree that ASEAN Integration would have an impact to the Higher Education institutions in the country with the computed mean value of 4.59.

7. There is no significant relationship on the profile of the AB Pol Sci student-respondents and their level of perception on the impact of ASEAN integration. However, there is a significant relationship among the teacher education student-respondents on their average monthly allowance and their level of perception on the impact of ASEAN integration.

8. There is a significant difference on the level of perception of the AB Political Science and Teacher Education respondents on the impact of ASEAN integration. Teacher Education has a higher level of perception since ( $\bar{x}$ ) mean is 4.59 while AB Political Science has 4.10.

**RECOMMENDATIONS**

The following are recommendations made by the researcher based from the findings and conclusion of the study:

1. The Higher Education Institutions of the country should be more creative and make its curricula to be an instrument of poverty alleviation. This can be done by upgrading the quality of public higher education to international standards and re-engineer governance as well as the administrative structures to our advantage without restricting academic freedom and institutional mandates.

2. The increase of enrolment of Higher Education Institutions should be coupled by a sound retention policy to maintain the quality of students and produce competitive graduates.

3. All the Higher Education Institutions in the country should make sure that their curricula are demand-driven for the better future of the graduates.

4. Further study should be conducted by other researchers to find out the relevance of amalgamating SUCs to the ASEAN Integration and consider the students, faculty members and school administrators as respondents

an Outcomes-Based and Typology-Based.

Edward D. Roguel, ASEAN Economic Community in 2015, [http://www.punongbayan.araullo.com/pnawebiste/pnahome.nsf/section\\_docs/LL161B\\_28-8-12](http://www.punongbayan.araullo.com/pnawebiste/pnahome.nsf/section_docs/LL161B_28-8-12)

Ina Hernando Malipot, DepEd playing catch-up for ASEAN 2015, December 11, 2013, <http://www.mb.com.ph/deped-playing-catch-up-for-asean-2015/>

Preparation for the ASEAN Community in 2015  
Thai Higher Education Review  
Vol.X No.33 July-September 2010

## ACKNOWLEDGMENT

The researcher would like to express his sincerest gratitude and appreciations to the following persons who shared their valuable help and support in making this study possible. To the faculty members who critiqued the content of this study during the in-house review namely, Dr. Lanie B. Tiu, Mrs. Maribel C. Ibañez, Mrs. Ruby A. Gabor and Mrs. Cheryl B. Diza; to Giddel Praise Floresca, the researcher's office staff, who is a big help in the encoding of data of this research study; the 3<sup>rd</sup> and 4<sup>th</sup> year AB Political science and Teacher Education students who served as respondents of this study and to the researcher's loving wife Marife, who is an inspiration in the conduct of this study. A million thanks!

## REFERENCES

- Alviento, Severino G. and Marife D. Alviento  
ASEAN Integration: The Researchers' Perspective, unpublished research study
- Angara, Edgardo, resolution calling on the Senate Committee on Trade and Commerce to conduct an inquiry into the opportunities and threats the looming integration poses on the country. [www.edangara.com](http://www.edangara.com)
- CHED Memorandum Order 46, series of 2012 Policy-Standard to Enhance Quality Assurance (QA) in Philippine Higher Education through

# EMPLOYMENT STATUS OF ACCOUNTANCY AND BUSINESS GRADUATES AT CATANDUANES STATE UNIVERSITY

Lily P. Custodio, Ph.D.<sup>1</sup> and Melinda V. Abichuela<sup>2</sup>

College of Business and Accountancy  
Catanduanes State University  
Virac, Catanduanes, Philippines 4800  
strategy58@yahoo.com<sup>1</sup> and yadnih45@yahoo.com.ph<sup>2</sup>

## ABSTRACT

*This study presents the employment status of accountancy and business graduates of Catanduanes State University from 2002 to 2008. Descriptive method of research was used with the questionnaire as the main tool in gathering the data. Respondents of the study comprised more than one-half of the total population. Purposive sampling method was employed. Descriptive statistics were used in analyzing the data. Results of data analysis revealed that the typical accountancy and business graduate of the university holds a degree in Bachelor of Science in Business Administration major in Management; graduated in 2004; currently employed related to the field of training in college; and get employed within six months to one year with a rank and file position. Reasons were provided for being employed not in line with their field of training in college. Suggestions were offered to improve the graduates' competitive edge in finding a job within their field of training in college. Recommendations were offered to improve the competitive edge of the graduates in getting employed together with the review of curricular programs to make them more responsive to the needs of the employer sector.*

Keywords: Catanduanes State University; employment status, accountancy and business graduates, relevance and responsiveness of curricular programs

## INTRODUCTION

Balmores (1990) Psacharopoulos (1994) and Orbeta (2002) reported that there is a mismatch between the funds spent on education and its returns to societal benefit. This means that there is a big gap between those graduates who are employed and those who are unemployed and even under-employed. However, up to the time of this writing, it shows that the common measure of the quality of graduates used in the country is the proportion of passing in professional board examinations. Tan (1995) commented that it would be better for state universities and colleges, in particular, to provide tangible measures on the quality of its graduates through employability. In this regard, it would project a realistic scenario that government funds allocated to education are indeed beneficial to both the graduates and the society.

Given this reality, public higher education institutions are therefore mandated to produce graduates who are qualified to serve the needs of the different societal sectors depending on the

field of specialization they obtained from college training. The Catanduanes State University (CSU) College of Business and Accountancy (CBA) envisions this fact that to give credit for the use of people's money, it must produce employable graduates. Additionally, it should continuously review whether its curricular programs are in consonance with the needs of the industry sector and other employers not only in the country but also in the other parts of the globe (Orbeta, 2002; Tan (1995).

Respondents of the study included accountancy and business graduates of the CSU from 2002 to 2008 in four degree programs, i.e., Bachelor of Science in Accountancy (BSA), Bachelor of Science in Business Administration (BSBA) majors in Management, Marketing and Entrepreneurship, Bachelor of Science in Business Education (BSBE) and Bachelor of Science in Office Administration (BSOA).

Results of this study may open avenues for policy decision making on areas affecting the systems

process of the institution. The manner by which inputs are transformed will have a direct effect on outputs. Thus, graduates are produced through the use of both tangible and intangible resources of higher education institutions. Output of this research would benefit the Board of Regents of the CSU as it may guide them in approving policies that are directly concerned with curriculum development, delivery of quality instruction by competent qualified educators, and state-of-the-art facilities and equipment necessary to facilitate learning. The administrators of the institution would be guided in deciding matters about sustainability of curricular offerings. The faculty members concerned could be provided some insights on relevant training needs required to improve teaching competencies. In addition, the industry and government sectors and other employers may be informed on what specific trainings are needed in the workplace in order for the graduates to be employable. Moreover, the students who are currently enrolled in the different programs of the College of Business and Accountancy (CBA) will be guided on what personal and academic preparations they need to be able to land a job immediately after graduation.

### Objectives of the Study

With the above cited viewpoints, this study was conducted to:

- find out the employment status of accountancy and business graduates; and
- determine the responsiveness and relevance of the curricular programs offered by the CBA in terms of:
  - (a) the number of graduates getting a job related to their field of training;
  - (b) graduates' reasons in choosing a job that is not in line with their field of training; and
  - (c) graduates' suggestions to improve their competitive edge in finding a job within their field of training.

### METHODOLOGY

The descriptive survey method of research was used in conducting this study. A questionnaire was prepared purposely to gather the data needed for this research. Documentary analysis was also utilized in gathering the data on the list of graduates from 2002 to 2008.

Data gathered from the respondents were coded in order to quantify them for statistical analysis. Descriptive statistics were used in summarizing the data gathered (i.e., simple frequency, percentage, and rank).

The population of this study comprises all graduates of the CBA who are listed in the Commencement Program from 2002 to 2008 with a total of 1,246 graduates (see Table 1). A sample of 654 graduates became the respondents of the study through purposive sampling technique (see Table 2).

Table 1. Population of the Study  
Table 2. Sample Size of the Study

Degree Programs	2002	2003	2004	2005	2006	2007	2008	Total
BSA	6	23	31	33	17	23	9	142
BSBA-Entrep	16	18	7	20	24	32	27	144
BSBA-Mgt	31	57	26	54	38	26	26	258
BSBA-Mktg	59	40	29	38	49	32	30	277
BSBE	48	40	41	39	31	50	37	286
BSOA	21	23	27	24	8	17	19	139
<b>Total</b>	<b>181</b>	<b>201</b>	<b>161</b>	<b>208</b>	<b>167</b>	<b>180</b>	<b>148</b>	<b>1,246</b>

Particulars	Frequency	Percent	Rank
<b>a. Degree Programs Completed</b>			
▪ BS Accountancy	96	14.68	4
▪ BS Business Administration – Entrepreneurship	72	11.01	6
▪ BS Business Administration – Management	152	23.24	1
▪ BS Business Administration – Marketing	147	22.48	2
▪ BS Business Education	83	12.69	5
▪ BS Office Administration	104	15.90	3
<b>Total</b>	<b>654</b>	<b>100.00</b>	
<b>b. Year Graduated from College</b>			
▪ 2002	88	13.46	5
▪ 2003	82	12.54	7
▪ 2004	106	16.21	1
▪ 2005	100	15.29	2
▪ 2006	94	14.37	4
▪ 2007	97	14.83	3
▪ 2008	87	13.30	6
<b>Total</b>	<b>654</b>	<b>100.00</b>	



Table 2 shows that of the total 654 respondents across the seven-year period, graduates in the BSBA major in Management recorded the highest number followed by BSBA major in Marketing, and the third dominating group were graduates of Bachelor of Science in Office Administration.

## FINDINGS

The employment status of the graduate-respondents was analyzed in terms of (a) employment information, (b) length of time to land the first job after graduation from college, (c) nature of employer's business, and (d) present job position, as summarized in Table 3.

Table 3. Employment Status of the Respondents  
Four-hundred eighty-eight or 74.62 percent of

Particulars	Frequency	Percent	Rank
<b>a. Employment Information</b>			
▪ Employed	488	74.62	1
▪ Self-employed	34	5.20	3
▪ Unemployed	132	20.18	2
Total	654	100.00	
▪ With jobs related to field of training (including the self-employed)	424	81.23	1
▪ With jobs not related to field of training	98	18.77	2
Total	522	100.00	
<b>b. Length of Time to Land the First Job after Graduation from College</b>			
▪ Less than six months	132	27.05	2
▪ Six months to one year	194	39.75	1
▪ One year to two years	86	17.62	3
▪ More than two years	76	15.57	4
Total	488	100.00	
<b>c. Nature of Employer's Business</b>			
▪ Service	170	34.84	1
▪ Manufacturing	32	6.56	5
▪ Commercial	151	30.94	2
▪ Financial	65	13.32	3
▪ Agricultural	6	1.23	6
▪ Government Agency	64	13.11	4
Total	488	100.00	
<b>d. Present Job Position</b>			
▪ Casual/Contract of Service	59	12.09	2
▪ Rank and file	367	75.21	1
▪ Supervisory level	33	6.76	3
▪ Managerial level	29	5.94	4
Total	488	100.00	

the respondents are employed, 34 (5.20%) are self-employed, while 132 or 20.18 percent are unemployed. These data support the contentions of Balmores (1990), Psacharopolous (1994), Orbeta (2002), and Tan (1995) that the employability of graduates provide a realistic scenario of government funds allocated to education which must be beneficial to both the graduates and the society.

Four hundred twenty-four respondents report-

ed that they have jobs which are related to their field of training in college. These data include the 34 respondents who are self-employed. However, 98 of those who are employed were found to have jobs that are not related to their field of training in college.

One hundred ninety-four of the 488 employed graduates-respondents in the private or public sectors were able to find jobs within six months to one year; followed by 132 who landed jobs in less than six months. Seventy-six or 17.62 percent had to wait for one year to two years before getting employment. More than two years passed before the 76 respondents found a job.

The largest number of employed graduates was found to be employed in the service industry; followed by those employed in commercial establishments and those in the government sector. The least number of employed graduates was those in the agricultural sector. In terms of present job position, data revealed that majority of the respondents occupied rank and file positions.

Results of data analysis on the length of time to land the first job after graduation from college parallel with the report of Arajo (1999), Del Valle et al. (2006), Duran (1997) and Miranda, Osorio, Sicio, and Talan (2003) that majority of the graduates from the CSU-CBA who participated in their studies were found to be able to secure their first job in less than a year.

Further, results of the analysis of data on the nature of employer's business are in agreement with what was reported by Miranda et al. (2003) that majority of these graduates are employed in private firms or offices both in and out of the province of Catanduanes.

In determining the responsiveness and relevance of the curricular programs offered by the CBA, the first determinant was investigated in terms of the number of graduates getting a job related to their field of training.

As summarized in Table 4, majority of the respondents grabbed the opportunity to be employed even if it is not in line with their field of training in college. This supports the contention that there are not many jobs available for the graduates. In another note, it could be that their college training is inadequate. As a consequence therefore whatever job is available or there is a

job opening the graduates would apply for it.

Table 4. Percentage Scores Obtained for the Respondents' Reasons in Choosing a Job Not in Line with Their Field of Training in College

\*Percent of respondents who chose indicator (each respondent may choose up to three indicators; 98 respondents reported jobs which are not in line with their field of training in college).

Data on the inadequacy of college training suggest that the responsiveness and relevance of the curricular programs offered by the CBA need

Item No.	Indicators for the Reasons	Frequency	Percent*	Rank
4	At the time I was looking for a job, this was the job available so I grabbed the opportunity even if it is not in my field of training in college.	76	77.55	1
3	There was an opening in this field which I immediately applied for.	66	67.35	2
1	I could not get a satisfactory job in my field of training; either the pay is low or I do not like the job available.	61	62.24	3
2	My training is inadequate; I could not compete with other graduates from other universities in the same field.	58	59.18	4

to be revisited. This has a connection in all the other aspects affecting instruction such as equipment, laboratory and library facilities, competence and capability of the faculty, and a harmonious environment conducive for learning as supported by qualified and competent staff.

Considering the reasons cited by the respondents in grabbing an employment opportunity although it is not within their field of training in college, this study also looked into the respondents' suggestions on how to improve their competitive edge in finding a job within their field of training in college. All respondents, whether employed, self-employed or unemployed, provided their suggestions (see Table 5).

Table 5. Percentage Scores Obtained for the Respondents' Suggestions to Improve Their Competitive Edge in Finding a Job Within Their Field of

### Training In College

\*Percent of respondents who chose indicator (each respondent could choose up to three indicators; all respondents were asked to provide their suggestions).

Majority of the respondents were willing to provide feedbacks for the improvement of the university. Six indicators were listed in the questionnaire; however, the respondents were requested to choose up to three indicators.

Item No.	Indicators for the Suggestions	Frequency	Percent*	Rank
6	Provide a job placement program for graduating students.	525	80.28	1.0
5	Employ only competent faculty members; provide faculty development programs to update faculty and improve their teaching competencies.	514	78.59	2.5
3	Upgrade the facilities, e.g., computer laboratories, libraries, etc.	514	78.59	2.5
1	Review and update the curriculum and syllabi.	510	77.98	4.0
2	Add more major courses (that require realistic deliverables).	496	75.84	5.0
4	Limit the class size to 35 students (or less).	493	75.38	6.0

All suggestions were provided by the majority of the respondents. According to the ranking, the first suggestion was to provide a job placement program for graduating student.

The next two suggestions emphasized the need to employ only competent faculty members, and to upgrade facilities such as computer laboratories and the library.

They suggested also to review and update the curricular offerings and the syllabi by making them realistic through adding more major courses that require practical deliverables; and to limit the class size to 35 students or less.

These suggestions are all provided in the respective CMOs used as guides in preparing the curricular programs offered by the institution. Thus, these suggestions are reminders for CBA administrators to revisit its curricular programs.

## CONCLUSION

The typical accountancy and business graduate of the university holds a degree in Bachelor of Science in Business Administration major in Management; graduated in 2004; currently employed related to the field of training in college; get employed within six months to one year with a rank and file position.

Any job opening which the graduates can manage to do was accepted at the time they were looking for a job even if it was not in line with their field of training in college.

The suggestions offered by the respondents on how the graduates could be employable was given emphasis for the need to revisit or periodically review the curricular programs offered by the university.

## RECOMMENDATIONS

There is a need to improve the employability edge of the graduates to be able to get jobs in line with their field of training in college. It is recommended therefore that a job placement program must be established. This program will guide graduates in finding jobs after graduation. This program is a year-round activity that must be executed by a competent career placement officer.

The college must consider reviewing the curricular programs offered if such are still responsive to the needs of the current era. Hence, it is recommended to review not only the curricular programs but also all other aspects related in offering academic programs such as the qualifications of the faculty, and the availability of needed facilities.

## ACKNOWLEDGMENT

The authors wish to extend their heartfelt thanks to the accountancy and business graduates who willingly participated in this undertaking. A gesture of gratitude is also extended to their colleagues for their encouragement. The support extended by the Catanduanes State University's administration through the Research and Development Services is likewise appreciated.

## REFERENCES

- Araojo, A. E. (1999). The employment profile, waiting period and manpower utilization of Catanduanes State Colleges, College of Business and Accountancy Graduates, School Year 1993-1996, *Institutional Research*, Virac: Catanduanes State Colleges.
- Balmores, N. R. (1990). The quality of higher education in the Philippines, in Manalang (ed.) *Philippine Education: Promise and Performance*, Quezon City: UP Press.
- CHED Memorandum Order No. 46, Series of 2012 – Policy-Standard to Enhance Quality Assurance (QA) in Philippine Higher Education through an Outcomes-Based and Typology-Based QA.
- CHED Memorandum Order No. 03, Series of 2007 – Revised Policies and Standards for Bachelor of Science in Accountancy (BSA), as Amended.
- CHED Memorandum Order No. 22, Series of 2006 – Policies and Standards for Bachelor of Science in Office Administration (BSOA).
- CHED Memorandum Order No. 39, Series of 2006 – Policies, Standards and Guidelines for Bachelor of Science in Business Administration.
- Del Agua, E., Tabuzo, M. & Vargas, M. (2003) Status of Bachelor of Science in Business Education graduates of Catanduanes State Colleges from School Year 1996-2001, *Undergraduate Thesis*, Virac: Catanduanes State Colleges, College of Business and Accountancy.
- Del Valle, R. A., Evangelista, C. M., Belchez, H. R., Manlangit, G. S., Avila, C. S. & Agripa, E. B. (2006). Marketability of College of Business and Accountancy graduates, *Undergraduate Thesis*, Virac: Catanduanes State Colleges, College of Business and Accountancy.
- Duran, O. P. (1997). Performance in the professional board exam and status of employment of CSC nursing graduates, *Master's Thesis*, Virac: Catanduanes State Colleges Graduate School.
- Miranda, J. C., Osorio, J. D., Sicio, M. T., & Talan, M. C. (2003). Status of entrepreneurship graduates of the College of Business and Accountancy, *Undergraduate Thesis*, Virac: Catanduanes State Colleges, College of Business and Accountancy.
- Orbeta, A. (2002). Globalization and employment: the impact of trade on employment level and structure in the Philippines, *PIDS Discussion Paper*, Series No. 2002-04, February.
- Psacharopoulos, G. (1994). Returns to investment in education: a global update, *World Development*, 22, 1325-1343.
- Tan, E.A. (1995). *School Fee Structure and Inflation in Philippine Higher Education*, Quezon City: University



# STAKEHOLDERS' ASSESSMENT OF AN INSTITUTION'S UNDERLYING PRINCIPLE

**Lily Pantino Custodio**  
College of Business and Accountancy  
Catanduanes State University  
Virac, Catanduanes  
strategy58@yahoo.com

## ABSTRACT

*This paper presents the assessment of stakeholders on the underlying principle governing the existence of the Catanduanes State University-Graduate School. Assessing the existence of an organization is reviewing its vision, mission, goal and objectives. Descriptive method of research was used with the questionnaire as the main tool in gathering the data. Respondents of the study included master's and doctoral students, teaching and non-teaching personnel, administrators, alumni and other stakeholders comprising parents, officials and employees of government agencies, entrepreneurs, and religious leaders in the community. Purposive sampling technique was used. Statistical tools used in data analysis include frequency count, weighted mean and Kruskal Wallis statistic. The study ascertained that the stakeholders are fully aware of and highly accept the vision, mission, goal and objectives of the Catanduanes State University including the goal and objectives of the Graduate School. Each group of respondents has similar degree of awareness and acceptability to the vision, mission, goal and objectives of the Catanduanes State University and the goal and objectives of the Graduate School. None among them showed any difference in their assessment of the underlying principle of the institution. Recommendations were offered and directions for future research were identified.*

Keywords: stakeholders' assessment, institution's underlying principle, Catanduanes State University, Graduate School

## INTRODUCTION

The Catanduanes State University (CSU) as an institution of higher learning pursues the overriding philosophy of commitment, excellence and sustainability. It strives to provide quality education based on value system and holistic development as a center of excellence. It views its mission in terms of strong human capabilities through quality instruction, research, extension and production programs. This mission illustrates its existence. It provides answers to the question "What is the CSU for?" Given this scenario, a mission statement may be evaluated through several criteria. These criteria would involve the participation of stakeholders of the institution (Collins & Rukstad, 2008; Weihrich, Cannice & Koontz, 2009). The stakeholders include students, faculty members, non-teaching staff, competitors, educational planners, suppliers of materials and equipment that make the academic organization alive, the industries which are interested on the quality of its graduates, the public at large and all other individuals and organizations who are inter-

ested in the affairs of the institution. Thus, an educational institution should be proactive and dynamic in attaining its mission (Custodio, 2007; Hoy & Miskel, 2013). It plays a crucial role in sustaining the economic balance of the community where it is situated.

Sustainability and progress of any profit or non-profit organization can be attained through the patronage of its clientele and other stakeholders (Cummings & Davies, 2008; David, 2011). State colleges and universities (SUCs) are assured of clients given the nature of our society where many students are accepted in public higher education institutions. Hence, their existence is also assured.

Through this study, the administrators of this institution and also the management of the Graduate School (GS) would be informed of whether there is a need to reorient their students, faculty, employees, alumni and other stakeholders as to the reasons of their existence.

The stakeholders could be given the chance to provide their awareness and acceptability on the vision, mission, goals and objectives (VMGO) of the CSC and the goals and objectives (GO) of the GS. Knowing how aware they are to what this educational institution means and how they accept them is a challenge to educators and administrators in improving and sustaining where the institution is at present and where it will be going in the future.

### Objectives of the Study

The study was conceptualized for the purpose of determining the level of awareness and level of acceptability of stakeholders on the vision, mission, goal and objectives (VMGO) of the CSU including the goal and objectives (GO) of the Graduate School (GS). Specifically, the purpose of this investigation is to:

- determine stakeholders' level of awareness on the VMGO of the CSU;
- determine stakeholders' level of acceptability on the VMGO of the CSU;
- determine stakeholders' level of awareness on the GO of the GS;
- determine stakeholders' level of acceptability on the GO of the GS;
- determine difference in means on the level of awareness and level of acceptability of stakeholders on the VMGO of the CSU;
- determine difference in means on the level of awareness and level of acceptability of stakeholders on the GO of the GS;
- determine significant difference on the level of awareness among stakeholders on the VMGO of the CSU and on the GO of the GS; and
- determine significant difference on the level of acceptability among stakeholders on the VMGO of the CSU and on the GO of the GS.

### METHODOLOGY

The descriptive method of research was used with the questionnaire as the main tool in gathering the data. Respondents of the study included master's and doctoral students, teaching and non-teaching personnel, administrators, alumni and other stakeholders who are comprised of

parents, officials and employees of government agencies, entrepreneurs, and religious leaders in the community. The study was conducted during the second semester of school year 2010-2011.

The questionnaire items were subjected to face validity and reliability analysis. A 3-point Likert scale was used in answering the questionnaire items: fully aware/highly accept (2.51-3.00); aware/accept (1.51-2.50); and not aware/not accept (1.00-1.50). Purposive sampling technique was used. A total of 379 respondents participated in the study (see Table 1). Statistical tools used in analyzing the data include frequency count, weighted mean and Kruskal Wallis statistic.

Table 1. The Respondents of the Study

In the analysis of the data as presented on the tables, the following abbreviations were used: MDS (master's and doctoral students), TP (teaching personnel), NTP (non-teaching personnel), Alu (alumni), Adm (administrators), and OS (other stakeholders).

### FINDINGS

Stakeholders	Sample Size
Master's and doctoral students	131
Teaching personnel	52
Non-teaching personnel	53
Administrators	25
Alumni	48
Other stakeholders	70
<b>TOTAL</b>	<b>379</b>

The general weighted mean of other stakeholders is the lowest among the six groups of respondents (see Table 2). It can be deduced that the six groups of stakeholders who participated in the study are fully aware of the VMGO of the CSU but at slight varying degrees of full awareness. Rounding off the quantitative responses, however, they are all "fully aware" about the subject matter. The slight difference is seen on the nature of their involvement depending on their functions in the institution.

While the students, teaching and non-teaching staff, and administrators are people who are directly involved in the university's daily routine considering the interactions they have with the school, alumni and other stakeholders are people who are indirectly involved in these routine activities. Slight difference on the degree of

awareness could be explained by this reality. The lowest weighted mean on the category of “fully aware” was reported by other stakeholders. It suggests the other stakeholders have the least direct involvement in the operations of the CSU.

Table 2. Level of Awareness of Stakeholders on the Vision, Mission, Goal and Objectives of the Catanduanes State University

The findings that the stakeholders of CSU are aware of the reasons why the institution exists are congruent with the Constitutional mandate that public educational institutions should be accessible to its citizens. Thus, colleges and universities are mandated to offer quality educational services to its clientele (CMO No. 46, s. 2012).

The respondents’ weighted mean responses on the level of acceptability to the VMGO of the CSU illustrating “high acceptability” are summarized in Table 3.

Vision, Mission, Goal and Objectives of the CSU	Respondents’ Weighted Mean Responses					
	MDS	TP	NTP	Adm	Alu	OS
<b>Vision</b> A center of excellence providing quality education based on value systems and holistic human development.	2.94	2.98	2.85	3.00	3.00	2.76
<b>Mission</b> Strong human capabilities through quality instruction, research extension and production programs.	2.92	3.00	2.85	3.00	2.98	2.73
<b>Goal</b> Achieve leadership in the four-fold functions of the institution.	2.89	2.92	2.77	2.96	2.98	2.59
<b>Objectives:</b>						
1. Achieve excellence through quality education.	2.89	2.98	2.91	3.00	3.00	2.74
2. Be a leader in research.	2.76	2.98	2.70	2.96	2.96	2.54
3. Provide responsive extension services.	2.76	2.94	2.68	2.96	2.96	2.60
4. Increase productivity and income levels for self-sufficiency.	2.75	2.88	2.64	2.96	2.96	2.49

The stakeholders being fully aware, highly accept the vision, mission, goal and objectives of the CSU are satisfied with the services provided by the institution. Custodio (2008) reported that students enrolled in colleges and universities have their own expectation on the quality of the services offered by academic institutions.

Table 3. Level of Acceptability of Stakeholders on the Vision, Mission, Goal and Objectives of the Catanduanes State University

The assessment of the six groups of stakeholders depicted full awareness of the GO of the GS as indicated in Table 4.

Table 4. Level of Awareness of Stakeholders on the Goal and Objectives of the Graduate School

Awareness could be equated to familiarity on the information. This could also mean that the GS is doing its task of informing stakeholders of why it exists. However, dissemination of research outputs is wanting in terms of presentation and publication at the regional, national and international levels. Income generation through knowledge-

Vision, Mission, Goal and Objectives of the CSU	Respondents’ Weighted Mean Responses					
	MDS	TP	NTP	Adm	Alu	OS
Vision	2.92	3.00	2.83	3.00	3.00	2.79
Mission	2.88	2.94	2.77	2.88	2.96	2.76
Goal	2.89	2.98	2.74	2.92	3.00	2.67
Objective 1	2.89	3.00	2.83	3.00	3.00	2.79
Objective 2	2.82	2.96	2.75	2.92	2.96	2.57
Objective 3	2.85	2.96	2.66	2.96	2.96	2.64
Objective 4	2.82	2.96	2.70	2.96	2.96	2.66
<i>General Weighted Mean</i>	<b>2.87</b>	<b>2.96</b>	<b>2.75</b>	<b>2.95</b>	<b>2.98</b>	<b>2.70</b>

based ventures poses another challenge.

Results on the analysis of data on the level of acceptability of stakeholders to the GO of the GS depict a positive image as shown in Table 5. It appears that the GS has made its contribution towards achieving its purposes. However, the GS

Goal and Objectives of the GS	Respondents’ Weighted Mean Responses					
	MDS	TP	NTP	Adm	Alu	OS
<b>Goal</b> Train high level manpower for leadership in education, in the community, and in the respective professions through the building of skills and desirable human values.	2.85	2.96	2.72	2.96	3.00	2.67
<b>Objectives:</b>						
1) Improve the graduate student’s perspective about life, the community and the Profession.	2.87	2.96	2.74	2.96	3.00	2.80
2) Sharpen the skills and abilities in the discipline of the graduate student.	2.89	2.92	2.70	3.00	2.98	2.56
3) Develop the inclination and ability for critical thinking and research.	2.82	2.96	2.62	3.00	2.98	2.61
4) Challenge the graduate student at self-development through self-directed academic pursuit for excellence.	2.82	2.90	2.70	2.96	2.98	2.59
5) Disseminate research outputs to facilitate technology transfer, promote environmental conservation and sustainable development, preserve cultural heritage and foster community leadership.	2.76	2.79	2.60	2.84	2.94	2.40
6) Undertake activities geared towards generating income for institutional self-sufficiency.	2.76	2.88	2.91	2.88	2.94	2.50
<i>General Weighted Mean</i>	<b>2.82</b>	<b>2.91</b>	<b>2.71</b>	<b>2.94</b>	<b>2.97</b>	<b>2.59</b>

has a lot more to do to improve its services since none of the six groups of stakeholders provided a rating of “3”. This is a reality that the quest for excellence never ends.

Table 5. Level of Acceptability of Stakeholders on the Goal and Objectives of the Graduate School

The level of awareness and the level of acceptability of the respondents do not differ as shown in Table 6. The difference in means is minimal that it did not even reach 50 percent. These results suggest that all groups of respondents are fully aware and at the same time highly accept the VMGO of the CSU.

The previous similar study conducted for the GS was in School Year 2007-2008. Although the VMGO of the university was revised, it was immediately disseminated to all concerned. Along this line, the CSU is in the right direction. Advocates of strategic management emphasized that it is a must for any human organization to equip its stakeholders with the purposes of its existence

Goal and Objectives of the GS	Respondents' Weighted Mean Responses					
	MDS	TP	NTP	Adm	Alu	OS
Goal	2.89	2.94	2.70	2.92	3.00	2.77
Objective 1	2.89	2.98	2.75	3.00	3.00	2.76
Objective 2	2.86	2.96	2.74	2.96	3.00	2.69
Objective 3	2.87	2.96	2.70	2.96	2.96	2.69
Objective 4	2.85	2.94	2.77	2.88	2.96	2.76
Objective 5	2.82	2.90	2.60	2.84	2.98	2.69
Objective 6	2.79	2.94	2.92	2.80	3.00	2.69
<i>General Weighted Mean</i>	<b>2.85</b>	<b>2.95</b>	<b>2.74</b>	<b>2.91</b>	<b>2.99</b>	<b>2.72</b>

(David, 2011; Pitts & Lei, 2007; Wehrich et al., 2009). Additionally, there is a need for a periodic review of these purposes as embedded in its mandate.

Table 6. Differences in Means on the Level of Awareness and Level of Acceptability of Stakeholders on the Vision, Mission, Goal and Objectives of the Catanduanes State University

Ho: The level of awareness and the level of acceptability of stakeholders on the vision, mission, goal and objectives of the Catanduanes State University are the same.

Responding to the call of a periodic review, therefore, is a must for any human organization. For as long as these organizations are providing services to their clienteles, their services must always embrace “quality assurance”. Customers expect for what is best all the time. Hence, improvement and enhancement of services being provided to consumers are imperative

(Ramasamy, 2009; Kotler & Armstrong, 2010).

No significant difference between level of awareness and level of acceptability on the GO of the GS was computed (see Table 7).

Table 7. Differences in Means on the Level of

Types of Respondents	Level of Awareness	Level of Acceptability	Difference	Remarks
Master's and Doctoral Students	2.84	2.87	0.03	No difference
Teaching Personnel	2.95	2.96	0.01	No difference
Non-teaching Personnel	2.77	2.75	0.02	No difference
Administrators	2.98	2.95	0.03	No difference
Alumni	2.98	2.98	0.00	No difference
Other Stakeholders	2.64	2.72	0.08	No difference

Awareness and Level of Acceptability of Stakeholders on the Goal and Objectives of the Graduate School

Types of Respondents	Level of Awareness	Level of Acceptability	Difference	Remarks
Master's and doctoral students	2.82	2.85	0.03	No difference
Teaching Personnel	2.91	2.95	0.04	No difference
Non-teaching Personnel	2.71	2.74	0.03	No difference
Administrators	2.94	2.91	0.03	No difference
Alumni	2.97	2.99	0.02	No difference
Other Stakeholders	2.59	2.72	0.13	No difference



Ho: The level of awareness and the level of acceptability of stakeholders on the goal and objectives of the Graduate School are the same.

The difference obtained for other stakeholders is the largest among the six groups. These results suggest that other stakeholders, being composed of different groups in the society, have varied understanding about the existence of the university. It may be interpreted in terms of their affiliation or involvement to the CSU and to the GS. For example, parents of students could be well-informed than local officials or religious leaders in the community.

Moreover, no significant difference at the 0.05 level of significance was tested on the level of awareness on the VMGO of the CSU and on the GO of the GS (see Table 8). The involvement of these stakeholders in the operations of the GS depends on their affiliation with this academic unit. However, despite of this reality their awareness on the GO of the GS did not differ. This could mean that they are all informed of what the university is doing in achieving its plans through the programs, projects and activities undertaken for each period of evaluation.

Table 8. Test of Difference on the Level of Awareness among Stakeholders on the VMGO of the CSU and on the Goal and Objectives of the GS

Ho: The level of awareness among stakeholders on the vision, mission, mission, goal and objectives of the Catanduanes State University and on the goal and objectives of the Graduate School

Particulars	Test Statistic	Computed Value	$\rho$ Value	Decision	Interpretation
Level of awareness among stakeholders on the VMGO of the CSU.	Kruskal Wallis (H)	1.145	0.17	Accept Ho	No significant difference
Level of awareness among stakeholders on the GO of the GS.	Kruskal Wallis (H)	1.156	0.11	Accept Ho	No significant difference

is the same.

No significant difference was gleaned from the results of the Kruskal Wallis test done on the data for the level of acceptability among the stakeholders (see Table 9). All stakeholders highly accept the underlying principle that guides the existence of the CSU.

Additionally, all six groups of respondents have similar level of acceptability on the GO of the GS. This finding suggests that the GS needs to scan the environment and offer academic programs that are relevant to the needs of this ever-changing environment.

Table 9. Test of Difference on the Level of Acceptability among Stakeholders on the VMGO of the CSU and on the Goal and Objectives of the GS

Ho: The level of acceptability among stakeholders on the vision, mission, goal and objectives of the Catanduanes State University and on the goal and objectives of the Graduate School is the same.

Particulars	Test Statistic	Computed Value	$\rho$ Value	Decision	Interpretation
Level of acceptability among stakeholders on the VMGO of the CSU	Kruskal Wallis (H)	1.087	0.21	Accept Ho	No significant difference
Level of acceptability among stakeholders on the GO of the GS	Kruskal Wallis (H)	1.192	0.22	Accept Ho	No significant difference

In summary, the tests of difference on the responses among stakeholders of the CSU on its VMGO and on the GO of the GS demonstrate that they are all fully aware and at the same time they highly accept the VMGO of the institution and the GO of the GS. This is, however, a reflection of the stakeholders' general assessment.

## CONCLUSION

The six groups of stakeholders were ascertained that they are fully aware of and highly accept the vision, mission, goal and objectives of the Catanduanes State University including the goal and objectives of the Graduate School.

No significant difference was found in their assessment. Hence, each group of respondents has similar degree of awareness and acceptability to the vision, mission, goal and objectives of the university and on the goal and objectives of the Graduate School.

## RECOMMENDATION

An in-depth review of the underlying

principle of the university must be conducted to give justice to what the administrators, the faculty members, the students, the government officials and all other stakeholders are continuously doing to make this premier institution worthy of its existence.

Similarly, a continuous periodic review is necessary for the Graduate School to keep track of recent educational developments in order to sustain quality academic services offered to the stakeholders.

Further, a study which will review the quality of services provided by the institution along its four-fold functions is also worth investigating.

### ACKNOWLEDGMENT

The author wishes to extend her heartfelt thanks to the respondents who willingly participated in this undertaking; and to the librarians and alumni services of the institution, her colleagues in the Graduate School, and to the Catanduanes State University's administration through the Research and Development Services for their unwavering support.

### REFERENCES

- CHED Memorandum Order No. 12, Series of 2012 – Policy and Standard to Enhance Quality Assurance (AQ) in Philippine Higher Education through an Outcomes-Based and Typology-Based QA.
- Collins, D. J. & Rukstad, M. G. (2008). "Can you say what your strategy is?" *Harvard Business Review*, 82.
- Cummings, S. & Davies, J. (2008). "Enabling bold visions", *MIT Sloan Management Review*, 49(2), 70.
- Custodio, L. P. (2007). *Strategic Planning and Decision Making in Educational Administration*. Virac, Catanduanes: Catanduanes State Colleges CIMC.
- Custodio, L. P. (2008). An evaluation of the quality of services provided by the Catanduanes State Colleges. *Research and Educational Development Training Institute, Vol. 4*, ISSN 1656-166X, January.
- David, F. R. (2011). *Strategic Management: Concepts and Cases*. New Jersey: Pearson Education, Inc.-Prentice Hall.
- Hoy, W. K. & Miskel, C. G. (2013). Educational Administration: Theory, research and practice. *Power Points for Hoy and Miskel*. Retrieved from [http://waynekhoy.com/power\\_point.html](http://waynekhoy.com/power_point.html)

- Kotler, P., & Armstrong, G. (2010). *Principles of Marketing: Global Edition*. Philippines: Pearson Education South Asia.
- Pitts, R. A. & Lei, D. (2007). *Strategic Management: Building and Sustaining Competitive Advantage* (4<sup>th</sup> ed.). Australia: Thomson South Western.
- Ramasamy, S. (2009) *Total Quality Management*, New Delhi: Tata McGraw-Hill Publishing Company Limited.
- Wehrich, H., Cannice, M. V., & Koontz, H. (2009). *Management: A Global and Entrepreneurial Perspective* (12<sup>th</sup> ed.). New Delhi: Tata McGraw-Hill Publishing Company Ltd.

# MAGIC REALISM IN HILIGAYNON URBAN LEGENDS

**Ruth Garcia Tribunal**

Language and Literature Instructor  
General Education Department  
Carlos Hilado Memorial State College-Alijis  
Bacolod City, Negros Occidental Philippines 6100

## ABSTRACT

*In the modern time, urban legends become unique and valuable stories in the community. These are living people's testimony about their experiences with mix magical and mundane elements in an overall context of realistic narrations. The primary concern of this paper was to analyze and evaluate the elements of magic realism in Hiligaynon urban legends. The study is a critical literary analysis conducted within the context of descriptive research. The tool used in critiquing the Hiligaynon urban legends was Magic realism. The result of the study showed that Hiligaynon urban legends have the elements of Magic Realism, such as Fantastical elements, Real-world setting, Plenitude, Hybridity, and Mystery. Also, the culture, belief and tradition of the region shaped the elements of magic realism in Hiligaynon urban legends. These could be evident in the plots, characters, themes and settings of the stories. The study concludes that there is a genre of magical or unreal elements in every Hiligaynon urban legend. The study recommends that the school may use Hiligaynon urban legends as materials in teaching regional literature for the students to recognize the beauty of their oral tradition.*

Keywords: Literary Critical Analysis, Magic realism, Hiligaynon Urban Legends

## INTRODUCTION

The Philippines has a great and vast oral tradition. Thus, our cultural information was passed on from one generation to the next by storytellers. The forms of oral tradition include poetry, folktales, and proverbs as well as magical spells, religious instructions, and recollections of the past. In the modern time, the lasting power of oral tradition would still be very evident despite the fact that there is the prevalence of radio, television, newspapers and the internet.

The stories of *Maria Labo*, *The Mysterious Death of Julie Vega*, *Bongbong Marcos is a Clone* and *The Robinsons' Half-human Half-snake* urban legends or modern folkloric stories are contemporary legends. They are the representation that affect the lives of the people in a particular place where the stories are told. Consequently, these stories are accepted as true whether the truth is known or not.

Brunvand (2012) defines an urban legend as a strong basic story-appeal, a foundation in actual belief, and a meaningful message or moral. In his book *"The Vanishing Hitchhiker"*, he stated

that "urban legends are too good to be true. They are unverified and too coincidental to interpret as literal truth."

Roger (2002) claimed that Magic realism tells its stories through the viewpoint of people who live in our world and experience a dissimilar authenticity that we consider unusual. He also added that Magic realism cannot be speculative based on guesses or ideas about what might happen or be true rather than on facts. However, not all urban legends are unreal; some of them came from real life stories of the people in the community.

With the use of Magic realism in critiquing the modern oral tradition, the researcher believes that Hiligaynon urban legends could be appreciated by the students especially the BSED major in English who deal with critical literary analysis.

As much as we give importance in the recording of the folklores and folktales of our ancestors, urban legends should also be given emphasis as they are the offspring of our rich oral tradition. The spread of urban legends in our com-

munity would show that oral traditions have not disappeared. Indeed, their settings may change, but their power and use remain.

### **Framework**

The study used the concept of magic realism in examining and analyzing the Hiligaynon urban legends. Magic realism has originated in the early twentieth century and was defined by Franz Roh (1995) as a new form of art. He also added that magic realism is a sequential assessment of artistic styles prior to the new form. Indeed, magic realism was placed determinedly between indistinct sensuality and extremely ordered schematics because it could be supernatural, fantastic or magical.

Magic and magical are created in specific cultural contexts. It follows that magic realism and magical realism have as many forms of magic and the magical in them as the number of cultural contexts in which these works are produced throughout the world (Bowers, 2004). This contemporary folklore purports to be true despite the unusual and extraordinary events, settings and characters in the story. For instance, an urban legend with a witch in a story of magical realism is not a fantasy element but a demonstration of the reality of people who believe in it and have real experiences with witches.

In relation to this, Zamora and Faris (1995) said that texts labeled magical realist upon cultural systems that are no less real than those upon that traditional literary realism draws (1995). They also claim that the primary narratives may be myths, legends, rituals and practices that bind communities together. Indeed, the narratives would show that people enjoy stories such as urban legends which demonstrate common denominators in culture and tradition within a particular community.

Subsequently, Leal (1995) said, “a writer confronts reality and tries to untangle it to discover what is mysterious in things and in human acts”. He also added that magic realism is an attitude towards the reality that can be expressed in cultured forms, close or open structures like the Hiligaynon urban legends. Magical realism in urban legends portrays the real world of people whose reality is different from others. With this, magic realism in urban legends is the finding of the unexplained connection amid man and his situations.

In all cases and ways, Roh (1995), Bowers (2004), Leal (1995), and Zamora and Faris (1995) stressed the beauty of magic realism in literature. Magic realism in Hiligaynon urban legends provide evidence on how the regional oral tradition amazingly evolved from generation to generation.

### **Objectives of the Study**

The primary concern of this study was to examine and analyze the Urban Legends that deal with various aspects of the life of Hiligaynon speaking people of what is ordinary, reality, fantasy or supernatural.

Specifically, the study sought to:

1) To identify the elements of Magic realism, such as fantastical elements, real-world setting, plenitude, hybridity, and mystery, in Hiligaynon Urban Legends;

2) To discuss the cultural influences that have shaped the use of Magic Realism in Hiligaynon urban legends;

3) To examine and analyze the elements of Magic realism in the plot, characters, themes and setting in the stories.

## **METHODOLOGY**

### **Research Design**

The study used critical literary analysis. This method is used to interpret the literary materials to make them more comprehensible to the readers. Questions about images, symbols, characters, plot, setting, and theme can be answered through this process (Garcia, 2001). Using this method, the researcher logically developed and presented sufficient evidence from the texts to show the elements of magic realism in Hiligaynon urban legends. Also, the researcher showed a systematic analysis of the external structure and profound structure of the passages and classifies the elements of magic in the stories.

Specifically, in this study, Magic realism was used by the researcher to analyze and examine the connection of Hiligaynon urban legends to the culture, belief, and tradition of Hiligaynon speaking people.

### **The Research Procedure**

In completing the study, the researcher followed the following steps:

The researcher conducted the study enti-

tled *"Hiligaynon Urban Legends: A Compilation"*. Then, the researcher used the identified urban legends. Passages from the stories were highlighted to guide the researcher to identify important ideas encompassed in urban legends. After that, second and third readings of the same stories were done. This time, repeated ideas were tabulated for identifying the themes. Next, a consultation was made with fellow teachers, students, and literary enthusiasts to verify the concepts or ideas. Subsequently, the themes were identified and the works were re-read to verify the existence of the ideas. Lastly, the characters, settings, and plots were re-examined to show how the elements of Magic realism in the identified Hiligaynon urban legends affect the development of the stories.

In reading the gathered Hiligaynon urban legends, the researcher was guided by the assumption that there is magic realism embedded in the stories. The researcher considered the idea of interpreting the theme of magic realism by exploring the meaning of the passages in the stories based on how she interpreted and understood the texts.

## RESULTS AND DISCUSSION

### **Magic Realism in the story "Amaranhig sang La Castellana, Negros Occidental" (Native Zombie in La Castellana, Negros Occidental)**

Every culture has a memorable kind of literature. In the Visayas region of the Philippines, the story of Zombies or Amaranhig, as the locals would call them is an example. In "Pedro Penduko", Amaranhig is defined as a vampire who failed to transfer his monstrosity to a member of the family. This causes him to rise from his grave to kill humans by biting their necks.

Scott (1994) described Amaranhig to have canine fangs. A person attacked by this local zombie could only escape by running in zigzag direction or by climbing a tree. Amaranhig has a stiff body. The monster can only walk in straight direction and cannot climb trees. Also, bodies of water are good hiding places because Amaranhig is afraid of waters.

The magical elements in the story were so apparent. The character and actions of Amaranhig show fantastic elements as it portrays fantastical events in a real setting (Zamora, 1995). For instance, the dead body moved inside the coffin,

rose and walked to the direction of the stairs of his house. He sat there as if he has life again. Thus, the people who claimed to have witnessed it were shocked at the same time afraid. The character and the actions of Amaranhig have a fantasy trait which shows that magic realism is present in this urban legend.

Subsequently, the event when the Amaranhig asked for water also shows fantastic element. It is a magical realism because a dead man cannot be thirsty and has no ability to drink water. Those who witnessed the event claimed that it was true because the son of Amaranhig gave him water to drink.

On the day they buried the body of Amaranhig, the family intentionally did it face down. He would not rise from his grave then. Until now, people in La Castellana believe that the buried Amaranhig has never rested because he is still alive under the ground. Consequently, the face-down position of his body would let him dig the earth continuously every time he feels the urge to rise from his grave.

Moreover, the story of Amaranhig in La Castellana, Negros Occidental also gives a different definition to this monstrous creature. According to the local folks, Amaranhig is not as hideous as the local vampire (aswang) or zombie. In some Amaranhig stories in the place, they die for days then rise from death if they are not able to transfer their being Amaranhig to any member of the family. They never do harm to the people around them as what Scott (1994) defined and the TV show "*Pedro Pendoko*" showed. They just usually sit down or walk around their houses.

The researcher then believed that being Amaranhig in La Castellana is a situation of a cursed family member. An ancestor in the past was cursed not to have the chance to rest in his old age no matter how sick, tired or old he was. If a member of the family, particularly the first-born child claimed the curse, he could take a rest. As he lived his life, he could act as an ordinary individual without extraordinary abilities. Only that, he will be a zombie unless, another member of the family claims the curse. This situation will continue to happen from generation to generation in the family.

Moreover, people claimed that this event happened in Hacienda Malaga, in La Castellana,

Negros Occidental. With this, the element of real-world setting is evident. The subsistence of fantasy elements in the real-world provides the basis for magical realism. People do not attempt to invent a new world in the story, but reveal the magical elements in this real-world in the real-time, as in the urban legend of Amaranhig. In the urban legend of Amaranhig in La Castellana, Negros Occidental, the dual world of magical realism and the supernatural dominions merge with the ordinary and recognizable world.

### **Magic Realism in the Story “Babayi nga gin Yanggaw sa Hinigaran” (A Woman Inflicted to be a Native Vampire in Hinigaran)**

The *Aswang* also known as vampire of the Philippines is considered to be the most prolific hideous monster in Philippine folklore. As a matter of fact, the term “*aswang*” refers to various types of creatures that belong in these monsters (Miller, 2007). Similar to *Aswang* is *Ek-ek* or *Wakwak*. Miller described it as a bird-like human. This hideous monster turns into large birds or bats and lurks at night. The *Ek-ek* is named because this monster produces an “*ek-ek-ek*” sound when attacking its victim. The *Wakwak* is named because it emits sound of “*wak-wak-wak*” when it flies. In Negros Occidental, this monster is locally known as *Tiktik* as it also produces a dull *tik-tik-tik* sound at night.

Local stories would tell that being an *aswang* runs in the family. Therefore, parents transfer their monstrosity to their children. Another way of transferring the atrocity of *aswang* is through “*Yanggaw*”. *Yanggaw* is an Ilonggo term which means eerie “infliction” that can transform a normal human being into one of the horrific *aswang*. The movie “*Yanggaw*”, that starred Ronnie Lazaro (Junior) and Aleera Montalla (Amor), defined the word *yanggaw*. Junior’s daughter, Amor, returned from another barrio with a mysterious illness. Eventually, Amor degenerated into a rabid and murderous *aswang* at night.

The story of a woman named Syvel, who worked as a local gambling collector, in Hinigaran, Negros Occidental is an example of *yanggaw*. In an interview made by a local radio station in Hinigaran, Syvel claimed that an old man whispered to her the numbers he wanted to bet in STL (Small Time Lottery). After that, she started to feel an unexplained illness in her body. When she went to an *albularyo* (local quack doctor), he said that an *aswang* inflicted or *yanggaw* her to be like

them. She then connected her encounter with the old man to the claim of the *albularyo*. She said that while the old man was whispering to her the numbers, she felt his saliva in her ear.

It is a local belief among Hiligaynon speaking people that if an *aswang* intentionally placed his saliva in the ear of a human being, that person will turn into a horrific *aswang*. The person experienced an eerie infliction or *yanggaw*. Thus, magic realism is very much apparent in this situation; the sense of mystery in this magic realist urban legend tends to intensify the level of events. Moreover, the element of plentitude is also present in the process of inflicting the victim to become *aswang* (Zamora, 1995).

Syvel and her family claimed that she tried to fight the *yanggaw*, especially, when she already had the urge to taste the human blood. It became the reason why she was very sick. At this moment, her parents decided to take her home as the *albularyo* said, “You should not stay in the place of your husband where the *aswang* had inflicted you”.

Also, the event when Syvel’s saliva would enormously fall from her mouth to her whole body shows one of the characteristics of *aswang*. Her husband would even claim that the saliva was glued to the wall. This event shows fantastic element because the story maintains the reliable tone of the objective report (Zamora, 1995).

The element of real-world setting could be applied in the event when the *Tiktik* attacked the house of Syvel as it happened in the real-world (Zamora, 1995). People in Ubay claimed that the *tiktik* who inflicted Syvel bothered them the whole night. Also, they ran after the *Tiktik* to protect Syvel. People said that the *Tiktik* jumped and hopped from one roof to another. He even hid from the trees. The *tiktik* did not succeed to get Syvel. So after three days, he went back to the place of Syvel with two other *Tiktiks*. The people opened their lights and stayed outside their houses, so the attacking *tiktiks* were not able to enter the place of Ubay.

Eventually, Syvel died because the *tiktik* who inflicted her did an *orasyon* (an evil’s prayer). According to the local residents, the *tiktik* chose to kill her because he cannot get her and make her as their own. This event shows a sense

of mystery and fantasy.

### **Magic Realism in “Ang Istorya ni Tan Juan Araneta” (The Story of Tan Juan Araneta)**

A sugar planter named General Juan Araneta or locally known as Tan Juan made a big mark in the history of Negros Occidental. Aside from being the extolling local hero of the province, Tan Juan also became the center of some urban legends. Literarily, Tan Juan has three famous urban legends that have fantastic and magical elements.

His ability to know the activities of his *obreros* (farm workers) even though he was in his mansion the whole day shows his magical characteristic. His obreros would often be shocked every time Tan Juan knew that they did not follow what he ordered. They were confused how he knew their activities at the farm even though he was in his mansion the whole day. This fantastic element in the character of Tan Juan became the real experience of his obreros with him; thus, it gives a realistic tone.

He had a magical robe from the *Sulta of Kanla-on* (King of Encantos who lives in Mt. Kanla-on) that could transport him anywhere he wanted. Also, he had a horse named Requito that had extraordinary abilities. Also, Tan Juan could easily disappear every time he rode his horse. Lastly, the golden robe of Tan Juan gives him the ability to be in a place he desired. Tan Juan's magical robe and horse show a strong sense of magic realism.

### **Magic Realism in “Ang Tawo nga Man-og sa Gaisano Mall sang Bacolod City (The Half-human half-snake in Gaisano Mall in Bacolod City)**

In the Philippines, the story about twin snake or human being giving birth to a snake is not new. The Visayan epic *Amaya* shows this kind of story in the Philippine folktale. In the modern time, the urban legend of a human snake in Gaisano Mall in Bacolod City became famous in the 90's. The locals believe that the human snake brings luck to his family.

In the story of “The half-human half-snake in Gaisano Mall in Bacolod City”, the people claimed that the family brings the human snake in any branches of Gaisano malls that do not earn big. Thus, most people say that the human snake permanently stays in the basement of

Gaisano mall in the downtown area of Bacolod City. People also believe that every time the human snake is hungry, he will pick one unlucky, beautiful young lady that is using the mall's dressing room. The floor is said to open, sending the lady into the dark basement, where the human snake dwells, and he will eat her. In some version of the stories, the snake rapes the lady before eating her. Other stories say that the human snake sometimes free some of his victims with the promise that they will not tell the story to anyone.

This urban legend has an obvious spice of magic realism. Though, on the outside, the story has no magical features, the character of the human snake breaks the rules of our real-world by attributing to it a fantastic element (Zamora, 1995). Also, the story gives accurate details of the real-world setting. It tells the people about the reference of the human snake, the family where he belongs and the place where he stays. The action of the human snake eating or abusing his victims would turn out to be an abnormal occurrence. Still, everything is conveyed in a real setting.

### **Magic Realism in “Ang Tatlo ka Misteryoso nga Puno sa Highway sang Silay” (The Three Mysterious Trees in the Highway of Silay City)**

The belief in the existence of supernatural powers and beings has a big part in the Philippine oral tradition. Hiligaynon people also share a vast part of this tradition. In Negros Occidental, many people believe that the three Bubog trees in the highway of Silay City are the legendary home of the *encantos* or the enchanted ones. Old people refer the *encantos* as elementals; they are as old as the trees, mountains, and rivers. In another popular belief, they are known as the fallen angels who revolted with Lucifer against God. When God exiled them from heaven, they continued to live on Earth sharing the world with the mortals.

Locals believe that the *encantos* could show themselves in whatever form they want, human or not. Moreover, their ability to appear as humans gives them the avenue to interact and communicate with the mortals. If they are in human form, their peculiar characteristic is the lack of the philtrum, the indentation below the nose and above the upper lip. Thus, the presence of the *encantos* might be out of this world but reportedly true by the people who encountered them. Indeed, the story of “The three mysterious trees in the highway of Silay City segments magic realism.

The *encantos* in this story share the world

with human beings, but they live in another dimension of the world. The situation explains that a place that we consider land with the houses, plantation and street could be a body of water or sea in their world. This supernatural belief could be the reason why most drivers who survived in the rampant vehicular accidents in front of the three mysterious trees would always claim that they saw a huge luxury ship crossing the highway. The vessel with its sound and lights distracted the drivers that led them to a deadly accident.

The presence of the human world and the *encantos* in one setting, but with different dimensions shows the element of Hybridity. It mixes multiple planes of reality or inharmonious grounds of such opposites (Zamora, 1995). Consequently, there is the shaking of the houses near the small river every time the ship passes. There is also the road-shaped dried part of the sugarcane plantation that started from the mysterious trees and ended to Mt. Kanla-on. These two occurrences could be clear evidence that the things we see in our world are not the same as of the *encantos*, even though we share the same planet.

The mysterious element of fantasy could also be evident in the story. Every time a person passes by the trees at 12:00 noon, he could smell delicious food. They even say that the smell could also be the same as the food which mortals eat. Also, people could hear the sound of someone washing the plates. This situation shows that the *encantos* live like the individuals in another dimension. Also, they die as there are young, old, female and male *encantos*. Consequently, the three trees represent their palace, church, and hospital. The old people living in the area claim that some of them had the chance to see the real images of the mysterious trees.

In the story, the element of real-world setting could be evident in the account when the *encantos* bought the ten Mercedes Benz. Old people in the area even claimed that they saw the cars passed by the street and vanished as the cars approached the three mysterious trees. In the modern time, when the owner of the sugarcane planned to make the plantation into a subdivision, a man with a bag full of money went to the office of the construction firm. According to the people who witnessed the event, the man bought the area where the mysterious trees are located to be sure that the company would not cut the trees as part of the development. After his meeting with the man-

ager, he went to the Mercedes Benz, in just a blink of an eye, according to the security guard, the man and the car vanished in front of the building.

### **Magic Realism in “Ang Milagro ni San Vicente Ferrer sang Brgy. Vito, Sagay” (The Miracle of San Vicente Ferrer of Brgy. Vito, Sagay)**

In a country where there is a very strong Christian faith like the Philippines, stories about the miraculous saints become ordinary. In Barangay Vito, Sagay City, Negros Occidental, Saint Vicente Ferrer becomes the hope of the people who are weary and sick. People in the island go to Barangay Vito hoping to have miracles from Saint Vicente Ferrer. Locals would do “*patapak*”, a vernacular which means to be stepped. They would bow their heads in front of the statue of Saint Vicente Ferrer. The person in charge would hold the sculpture of the Saint so his feet could step on the head or body of the sick people. They do this practice as their “*panata*” (promise) to seek healing from the Saint.

People claimed that Saint Vicente Ferrer healed them because of their belief (*panata*). With this, the element of magical realism would be evident in this story. The sick people became well again after they do “*patapak*” and pray for the help of Saint Vicente Ferrer. Consequently, more people go to Vito church. Medicine and Science are not considered important because the people’s faith already healed them. This part of the story has fantastic element as the character of Saint Vicente Ferrer does miraculous things to the people in what it claims real-world setting (Zamora, 1995).

Also, in the event in the story when a wood tried to follow the boat of the fisherman and his wife, the magical element is shown. They got rid of the wood, but it continued to shadow them until they decided to bring it home. In this situation, a highly detailed, realistic setting is invaded by something too strange to believe. Moreover, this urban legend was categorized as magical realism when the wood turned into the statue of Saint Vicente Ferrer. The miraculous events confused the people so they just simply explained that the miracles are from God and Saint Vicente Ferrer is God’s way to help the weary and sick people.

The stories that I heard became a part of my growing-up years. They give an immense influence to my life. As these stories lead me to the belief that human beings are not the only ones



living in this world, I become conscious of the ways I deal with the unseen world. For instance, if I am new to a place, I utter the words “tabi tabi” which means “excuse me” so the elementals that I could not see will not harm me. I personally believe that these elementals are evil and capricious all the time. They would never consider the fact that human beings could not see them. Thus, they harm us if we hurt them unaware.

Moreover, these contemporary folklores clearly and vividly explain the beautiful cultural belief of Hiligaynon people. Indeed, the Hiligaynon urban legends could make a different mark compared to the urban legends of other regions in the country. Also, a strong sense of magical elements is common in Hiligaynon urban legends, which shows that Hiligaynon speaking people have unique ways of explaining and understanding a particular phenomenon.

Subsequently, this study shows a very important discovery in most mythical characters. First, Amaranhig in Hiligaynon setting is not an *aswang* who was not able to transfer his being aswang to a member of his family. Instead, he is just an ordinary person who never harms other people. His ancestor who did bad things to another person cursed him not to have peaceful death, unless someone is willing to take the curse.

Second, the idea of *yanggaw* is common among Hiligaynon urban legends. Most Hiligaynon people would say to bring *suwa* or *calamansi* every time they attend a *fiesta*. If they squeeze *calamansi* on the food they are eating, they could see if it is a human body. You can be inflicted to be an *aswang* by eating the food that the *aswang* prepared or by saliva that the *aswang* will intentionally put inside a person’s ear.

Third, most Hiligaynon speaking people believe that the king of the *encantos* is the *Sulta* of *Kanla-on*. Thus, most *albularyos* or *quack doctors* go to the mountain to pray. Another point is that supernatural beings with extraordinary powers could be a part of the world where mortals move. Anyone who believes in God also believes in evil. The story prepared me to be more prayerful and more conscious of the things I do. A person may not know that he is facing an *Amaranhig*, an *Aswang* or even an *Encanto*. The lessons I get from these stories make me realize that there is evil and prayers are the best weapons God has given to us.

Fourth, the human snake would show to us that Hiligaynon speaking people have a unique way on how to explain the source of the wealth of the people. It is very easy to say that these people work hard to achieve success. But in the urban legends, the dark side of the rich family was discussed: connecting the source of their wealth to the evil and hideous son who eats and rapes his victim.

Lastly, in times of trouble and difficulties like experiencing a terrible illness, it would be a natural response to seek religious help. God sent His prophets to help us with our need. Those who are weary and weak tend to find strength from God. Thus, people go to miraculous churches to find refuge. The story of *Saint Vicente Ferrer* could open the eyes of the people that God continues to make ways on how to help us and make us realize that His love is overflowing.

#### **Cultural Context in Hiligaynon Urban legends**

The urban legends of Hiligaynon speaking people give an immense influence to the way they live. As these stories lead them to the belief that human beings are not the only ones living in this world, they become conscious of the ways they deal with the unseen world. For instance, if someone is new to a place, he utters the words “tabi tabi” which means excuse me so the elementals which I could not see will not harm me. I personally believe that these elementals are evil and capricious all the time. They would never consider the fact that human beings could not see them. Thus, they harm us if we hurt them unaware. This kind of practice is a part of Hiligaynon culture that was passed from one generation to another.

Moreover, these contemporary folklore clearly and vividly explain the beautiful cultural belief of Hiligaynon people. Indeed, the Hiligaynon urban legends could make a different mark compared to the urban legends of other regions in the country. In addition, a very strong sense of magical elements are common in Hiligaynon urban legends, this simply shows that Hiligaynon people have unique ways of explaining and understanding a particular phenomenon.

Subsequently, this study shows a very important discovery in most mythical characters. First, Amaranhig in Hiligaynon setting is not an *aswang* who was not able to transfer his being aswang to a member of his family. Instead, he is just an ordinary person who never harm other

people. His ancestor who did bad things to another person cursed him not to have peaceful death unless, someone is willing to take the curse.

Second, the idea of yanggaw is common among Hiligaynon urban legends. Most Hiligaynon people would say to bring suwa or calamansi every time they attend a fiesta so they would know if the food they are eating is a body of a human. You can be inflected to be an aswang by eating the food that the aswang prepared or by saliva that the aswang will intentionally put inside the ear.

Third, most Hiligaynon people who believe that the king of the encantos is the Sulta of kanla-on. Thus most albolaryo (quack doctors) go to the mountains to pray. Another point, supernatural beings with extraordinary powers could be a part of the world where mortals move. Anyone who believes in God also believes in evil. This made me more prayerful and more conscious of the things I do. No one could know that the person he is facing is in fact, an Amaranhig, an Aswang or even an Encanto. The lessons I get from these stories make me realize that evil is around and Prayers are the best weapons God has given to us.

Fourth, the human snake would show to us that Hiligaynon people has very unique way on how to explain the source of the wealth of rich people. It is very easy to say that these people work hard to achieve success. But in the urban legends, the dark side of the rich family was discussed: connecting the source of their wealth to the evil and hideous son who eats and raped his victim.

Lastly, in times of trouble and difficulties like experiencing a terrible illness, it would be a natural response to seek religious help. God sent His prophets to help us with our need. Those who are weary and weak tend to find strength from God. Thus, people go to miraculous churches to find refuge. The story of Saint Vicente Ferrer could open the eyes of the people that God continues to make ways on how to help us and make us realize that His love is overflowing.

## CONCLUSIONS

The elements of Magic Realism such as Fantastical elements, Real-world setting, Pleni-

tude, Meta-fiction, and Mystery, are evident in Hiligaynon Urban Legends. Second, there is a strong cultural influences which have shaped the elements of Magic Realism in Hiligaynon urban legends. Lastly, in the examination and analyzes the elements of Magic Realism are used in the plot, characters, themes and setting in the stories.

## RECOMMENDATIONS

The following recommendations were made in the course of the study:

1. Hiligaynon urban legends should be used as material in teaching regional literature.
2. The connections of history, culture and tradition through conventional and modern oral tradition should be taught in Philippine literature.
3. Appreciation of regional oral literature should be given emphasis in literature classes.

## REFERENCES

- Bowers, M. A. (2004). *Magic(al) Realism (The New Critical Idiom)*. Routledge. New York, USA.
- Brunvand, J.H. (2012). *Encyclopedia of Urban Legends: Vol 1-2*. Abc-Clio, LLC Inc., California, USA.
- Garcia, J. N. C. (2000). *The Likhaan Book of the Philippines Criticism 1992-1997*. U.P Creative Writing Center and the University of the Philippines Press.
- Leal, L. (1995). "Magic Realism in Spanish American Literature". *Magical Realism: Theory, History, Community*. Ed. Lois Parkinson Zamora and Wendy B. Faris. Durham, N.C.: Duke UP.
- Miller, A. (2007). *Magic Creatures and Non-Human*. Retrieved: December 23, 2014. <http://www.mysiquijor.com/MagicCreatures.html>.
- Roh, F. (1995). "Magic Realism: Post-Expressionism." *Magical Realism: Theory, History, Community*. Ed. Lois Parkinson Zamora and Wendy B. Faris. Durham, N.C.: Duke UP.
- Rogers, B. H. (2005). *What Is Magical Realism, Really?*. Retrieved: December 23, 2014. <http://www.writing-world.com/sf/realism.shtml>.
- Scott, William Henry (1994). *Barangay: Sixteenth Century Philippines Culture and Society*. Ateneo de Manila University Press. Quezon City.
- Zamora, L. P. and Faris, W. B. (1995). *Magical Realism: Theory, History, Community*. Duke University Press. USA.



# PERFORMANCE OF ROTC CADETS DURING THE ANNUAL ADMINISTRATIVE AND TACTICAL INSPECTION (RAATI): BASIS FOR INSTRUCTIONAL MANUAL

**Juliet S. Trujillo**

*Faculty, College of Education*

Carlos Hilado Memorial State College-Talisay Campus  
Mabini St. Talisay City, Negros Occidental, Region VI- Philippines

## ABSTRACT

*Army ROTC is one of the country's top leadership programs integrated in the curriculum. Many state colleges and universities and even private institutions offer Reserve Officers Training Corps (ROTC) as an elective in their curriculum because of its objectives and benefits. Thus, this study was conducted to assess the performance of ROTC Cadets during the Annual Administrative and Tactical Inspection (RAATI) in Region 6 as a basis for the conception of an instructional manual. Descriptive design utilizing documentary analysis was employed to 24 ROTC units of Region 6- Western Visayas. The statistical tools were mean for descriptive objectives and t-test for comparative objectives. The ROTC cadets performed well in both administrative and tactical aspect during RAATI but still they need more practice for the excellent performance especially in theoretical examination.*

*It is concluded that the ROTC Units of Region VI need training aids and reference materials such as instructional manual to enhance their performance.*

*In view of the above findings, instructional manual such as Module in Teaching Military Science will be recommended to all concerns in enhancing the mastery of skills in administrative and tactical aspects of ROTC.*

Keywords- Performance of ROTC Cadets, Regional Annual Administrative and Tactical Inspection (RAATI), Instructional Manual, Region VI, Philippines.

## INTRODUCTION

Many programs and opportunities develop leadership in tertiary level. As cited by Funk (2002), students are given numerous venues to act as leaders to their peers from athletics to clubs to student governments. However, very few students are provided any type of formal leadership training through an educational process. In the Philippines, Army ROTC is one of the country's top leadership programs integrated in the curriculum. Many state colleges and universities and even private institutions offer Reserve Officers Training Corps (ROTC) as an elective in their curriculum because of its objectives and benefits. In joining the army ROTC, one can avail the scholarship program for the qualified and deserving cadets and train to become a good leader, a manager and a good citizen (ARESCOM, n.d.). Hampton II (2013) proved this statement. According to him, military training instills leadership skills and

builds confidence in men. The current and future leaders of the Army will play a significant role in determining the ways that the Army trains and leads its soldiers of all ethnic backgrounds and ROTC programs throughout the nation. Army ROTC programs contribute immensely to the leader-development process for officers (Edwards, 2012).

Based on the implementing guidelines of NSTP-ROTC Component, Reserve Officers Training Corps was institutionalized under sections 38 and 39 of Republic Act No. 7077 which was designed to provide military training to tertiary level students in order to motivate, train, organize and mobilize them for national defense preparedness. In line with this, the Regional Annual Administrative Tactical Inspection (RAATI) is held during the start of the year, around mid-February wherein inspectors and guests challenge the skills, potentials and tactics of the different

units through many tests and inspections. The Region VI competition also aims to determine the extent of support provided by the school for the ROTC program and to determine the best-performing ROTC units in the region. This literature serves as guide to the researcher to enhance the body of knowledge on ROTC programs of Western Visayas.

The dearth of studies on the subject and the researcher's affiliation to a reserve force as a sergeant motivated her to come up with this study as she believes that the assessment of cadets' performance is one way in developing instructional manual to enhance their skills in times of disaster and insurgency. In addition, the researcher trusts that Reserve Officer's training Corps Program produces high caliber officers who will lead the Armed Forces of the Philippines for a better republic.

### **STATEMENT OF THE PROBLEM**

The main purpose of this study was to analyze the results of performance of ROTC cadets during the Annual Administrative and Tactical Inspection (RAATI) in Region 6 for the Academic Year 2013-2014 as basis for the development of an instructional manual.

Specifically, it aimed to answer the following questions:

1. What is the level of performance of ROTC cadets in terms of administrative and tactical when taken as a whole and when grouped according to:
  - a. school, and category?
2. Is there a significant difference in the level of performance of ROTC cadets in terms of administrative and tactical when taken as a whole and when grouped according to:
  - a. school, and category?
3. Based on the results, what instructional manual should be proposed?

### **METHODOLOGY**

This study used the descriptive research design utilizing the documentary analysis in order to attain its objectives. According to Johnson & Christensen (2012), the primary purpose of descriptive research is to provide an accurate description or picture of the status or characteristics

of a situation or phenomenon. On the other hand, Scott (2006) explained that the use of documentary analysis is to support the view point and a process of conceptualizing, using and assessing documents. Since, the researcher analyzed the documents on the results of Regional Annual Administrative and Tactical Inspection, the design was the most suited framework to use.

### **Subjects of the Study**

The subjects of the study were the 24 ROTC units of Region VI – Western Visayas during the 2nd semester of the school year 2013-2014.

### **Source of Data**

Data were gathered through the document provided by the 6 Regional Community Defense Centers. The document provided the data on the results of RAATI 2013-2014 of 24 ROTC units in the whole Region 6. It consisted of the criteria in the administrative aspect with 25 points allocation which is composed of the following: office organization & management, filing system, completeness of records, training aids & reference materials, ROTC commandant briefing, organic NCO Res MOI, and cadet organization and in tactical aspect with 75 points allocation which is composed of drill test (ceremonial parade, company drill, inspection in rank and school support), comprehensive examination (all subject – MS 1&2, MS 31&32, MS 41&42), practical examination (MOI 32) and operation order (MS 42), military stakes (military courtesy and discipline, M16, CAL 45, MAP reading, disaster relief & rescue operation, and small unit tactics). This document prescribed the inspection coverage and the point distribution that shall serve as the gauge of all quantifiable aspects of accomplishment in each field of endeavor. This shall be the basis in the criteria for the selection of the outstanding ROTC Unit of the year in Region 6.

### **RESULTS AND DISCUSSION**

The findings of the study are as follows:

1. Table 3 presents the performance level of ROTC cadets in the aspects of administrative when they were grouped according to school (private & public). It reveals that ROTC Commandant Briefing in both schools has the perfect score of 3.00 which is interpreted as excellent. The result implies that the commandants of every ROTC Units in the whole Region are well prepared. This is due to the fact that they used the standard format during the presentation and they

as well manifested authority and leadership. However, training aids and reference materials of public & private schools had the lowest mean score of 2.78 for public, 2.79 for private which are both interpreted as very good. This means that the instructional materials of ROTC units of Region VI should be used effectively to save time, add interest, and make the instruction easy. According to Principles and Methods of Training (n.d), all learning is through the senses. The more senses are brought into use, the more effective is the learning; 97 percent of learning is achieved through simultaneous appeal to the eye and ear. Instructors should properly use training aids to supplement their training.

It is also shown in the same table the whole performance of ROTC cadets in the area of administrative aspect when they were grouped according to school. The public schools have the mean score of 23.78 which is very good while the private schools have the mean score of 23.67 both interpreted as very good. The results imply that there are some areas that need improvement to get the perfect score of 25 in the administrative aspect.

Table 3. Performance Level of ROTC Cadets in the Area of Administrative Management According to school

2. Table 4 presents the data on the performance level of ROTC cadets in the aspect of tactical when they were grouped according to school. It reveals that public and private school had excellent performance in the area of drill test with the total points of 28.49 & 28.57 respectively. Their performance in ceremonial parade with the score of 13.44 in public & 13.36 in private is very good. This is also the same with their performance in company drill with the mean score of 7.30 & 7.47 respectively which were both interpreted as very good. On the other hand, in inspection of rank and school support & participation is excellent. The results imply that the cadets performed very well in this area. However, among the criteria on the tactical aspect, both

Areas	Public		Total Points	Private		Total Points
	M	I		M	I	
Office Organization & Management	2.83	E		2.82	E	
Filing System	2.82	E		2.89	E	
Completeness of Records	3.88	E		3.86	E	
Training Aids & Reference Materials	2.78	VG	23.78 "VG"	2.79	E	23.67 "VG"
ROTC Commandant Briefing	3.00	E		3.00	E	
Organic NCO Reserve MOI	3.83	E		3.77	V G	
Cadet Organization	4.64	E		4.54	V G	

Legend: M-Mean, E- Excellent, VG- Very Good, G- Good, P- Poor

public & private have the lowest mean score in comprehensive examination. In public, the performance of cadets in MS 1&2 with mean score of 2.66, MS 31&32 with 2.67, MS 41 & 42 with 2.45, all interpreted as fair. The same result in private schools in MS 1&2 with mean score of 2.73, MS 31&32 with 2.20, MS 41 & 42 with 2.43, all interpreted as fair.

This means that cadets find some difficulties in solving the theoretical problems. This is due to the fact that they find hard time in understanding and applying critical-thinking skills during problem solving. Cited in A New Approach to Leadership and Management (n.d), problem solving is part of decision making. A systematic process that focuses on analyzing a difficult situation, problem solving always includes a decision-making step. Although decision making is the last step in the problem-solving process, it is possible for decision making to occur without the full analysis required in problem solving.

In the area of military stakes, the cadets in public schools performed excellently in military courtesy and discipline (MCD, M16, Small Unit Tactic (SUT) and CAL 45, with the mean scores of 2.80, 3.91, 2.93 while in private schools performed well in the area of MCD with the mean score of 2.79 and excellently performed in M16 and CAL 45 with the mean scores of 3.90 and 2.93 respectively.

As a whole, their performance in tactical aspect is very good with the total scores of 67.06 in public and 66.61 in private. The results imply that cadets have knowledge on standing operating procedures on military tactics. This is due to the fact that they were trained by the army personnel and non-commissioned officers.

Table 4. Performance Level of ROTC Cadets in the Area of Tactical Aspect According to school

Table 5 presents the performance level of ROTC cadets in the administrative aspect when they were group according to category (A & B). It reveals that ROTC commandant briefing in both has the perfect score of 3.00 which is interpreted as excellent. The result implies that the commandants of every ROTC units in the whole region manifested excellent leadership. This is due to the fact that they are all army officers with higher rank and know best how to run their respective ROTC units. They followed the standard format set-forth by the highest headquarters during their

presentation. However, training aids and reference materials of public & private had the lowest mean score of 2.79 for category A, 2.78 for category B both interpreted as very good. This means that the ROTC units of Region VI utilized only the available instructional materials in their field.

Areas	Public			Private			Total Points
	Mean	I	Total	Mean	I	Total	
Points							
A. Drill Test							
1. Ceremonial Parade	13.44	VG		13.36	VG		
2. Company Drill	7.30	VG	28.	7.47	VG		28.57
3. Inspection in Rank	4.75	E	49	4.74	E		E
4. School Support & Participation	3.00	E	E	3.00	E		
B. Comprehensive Exam							
1. MS 1 & 2	2.66	F		2.73	F		
2. MS 31 & 32	2.67	F		2.20	F		
3. MS 41 & 42	2.45	F	15.	2.43	F		14.58
C. Practical Examination			07				G
1. MOI (MS 42)	3.75	E	G	3.73	E		
2. OPOD (MS 42)	3.54	VG		3.49	VG		
C. Military Stakes							
1. MCD	2.80	E		2.79	VG		
2. M16	3.91	E		3.90	E		
3. CAL 45	2.93	E	23.	2.93	E		23.46
4. MAP READING	4.52	VG	50	4.34	VG		VG
5. DRRO	4.53	VG	VG	4.72	E		
6. SUT	4.81	E		4.78	E		
Grand Total of Tactical Aspect			67.				66.61
			06				VG
			VG				

Legend: E- Excellent, VG- Very Good, G- Good, P- Poor

Table 5. Performance Level of ROTC Cadets According to Category

3. Table 6 presents the data on the performance level of ROTC cadets in the tactical aspect when they were grouped according to category. It reveals that schools which belong to category A and B had excellent performance in area of drill test with the total points of 28.55& 28.46 respectively.

However, among the criteria on the tactical aspect, both categories have the lowest total points of 14.63 and 15.25 in comprehensive examination both interpreted as “good”. This means that cadets find some difficulties to make generalizations and to solve problem in all the concepts and theories taught to them from MS 1 & 2, MS 31 & 32, and MS 41 & 42 subjects. This is due to the fact that comprehensive examination requires higher thinking skills and cadets need reading materials, and references and dif-

ferent instructional strategies to develop these skills. According to Snyder, Lisa Gueldenzoph &

Areas	Category "A"			Category "B"		
	M	I	Total Points	M	I	Total Points
Office Organization & Management	2.80	E		2.85	E	
Filing System	2.85	E		2.81	E	
Completeness of Records	3.85	E		3.90	E	
Training Aids & Reference Materials	2.79	VG	23.72	2.78	E	23.69
			“VG”			“VG”
ROTC Commandant Briefing	3.00	E		3.00	E	
Organic NCO Reserve MOI	3.83	E		3.74	VG	
Cadet Organization	4.60	E		4.60	VG	

Legend: E- Excellent, VG- Very Good, G- Good, P- Poor

Snyder, Mark J., (2008), critical thinking is a learned skill that requires instruction and practice. Instructors can enhance students’ critical thinking skills by (1) using instructional strategies that actively engage students in the learning process rather than relying on lecture and rote memorization,(2) focusing instruction on the process of learning rather than solely on the content, and(3) using assessment techniques that provides students with an intellectual challenge rather than memory recall.

In the area of military stakes, the cadets in category A have the total scores of 23.44 and category B has 23.55 total scores, both interpreted as very good. The result implies that cadets performed well in MAP reading, DRRO, SUT and most of them excellently performed in MCD, M16, Small Unit Tactic and CAL 45.

As a whole, their performance in tactical aspect is very good with the total scores of 67.06 in Category A and 66.26 in Category B. The results imply that cadets know well on the different military tactics and operating procedures. They were knowledgeable on how to execute the drill test and military stakes.

Table 6. Performance Level of ROTC Cadets in the Area of Tactical Aspect According to Category

4. Table 7 presents the difference in the level of performance of ROTC cadets in terms of administrative and tactical according to school (private & public). It shows that in administrative management, the independent sample t-test with a t-value of 0.354 and a p-value of 0.558 > 0.05 interpreted as “not significant” at 0.05 alpha level. The same result in tactical aspect, which is the independent sample t-test with a t-value of 0.378 and a p-value of 0.065 > 0.05 interpreted as “not significant”. Therefore, the hypothesis which stated that there is no significant difference in the level of performance of ROTC cadets in the as-

pects of administrative management and tactical is accepted. This means that the performance level of cadets does not vary in every category regardless of the school they belong. This is due to the fact that each ROTC units in the whole region receive the same program of instruction.

Table 7. Difference on the Performance of Cadets when grouped according to school

5. Table 8 presents the difference in the level of performance of ROTC cadets in terms of administrative and tactical according to category where "A" has more than 350 cadets and "B" has

Areas	Category "A"			Category "B"		
	M	I	Total Points	M	I	Total Points
<b>A. Drill Test</b>						
1. Ceremonial Parade	13.41	VG	28.55	13.39	VG	28.46
2. Company Drill	7.40	VG		7.32	VG	
3. Inspection in Rank	4.74	E		4.75	E	
4. School Support & Participation	3.00	E		3.00	E	
<b>B. Comprehensive Exam</b>						
1. MS 1 & 2	2.64	F	14.63	2.80	F	15.25
2. MS 31 & 32	2.33	F		2.69	F	
3. MS 41 & 42	2.44	F		2.43	F	
<b>C. Practical Examination</b>						
1. MOI (MS 42)	3.73	E	3.76	3.76	E	3.76
2. OPOD (MS 42)	3.49	VG		3.57	VG	
<b>C. Military Stakes</b>						
1. MCD	2.77	E	23.44	2.80	VG	23.55
2. MI6	3.91	E		3.91	E	
3. CAL 45	2.93	E		2.93	E	
4. MAP READING	4.31	VG		4.52	VG	
5. DRRO	4.74	VG		4.58	E	
6. SUT	4.78	E		4.81	E	
Grand Total of Tactical Aspect			67.06	Very Good	67.26	Very Good

Legend: E- Excellent, VG- Very Good, G- Good, P- Poor,

less than 350 cadets. It shows that in administrative management, the independent sample t-test with a t-value of 0.0562 and a p-value of 0.462 > 0.05 interpreted as "not significant" at 0.05 alpha level. The same result in tactical aspect, which is the independent sample t-test with a t-value of 0.299 and a p-value of 0.098 > 0.05 interpreted as "not significant". Therefore, the hypothesis which stated that there is no significant difference in the level of performance of ROTC cadets in the aspects of administrative management and tactical according to category is accepted. The result implies that regardless of the number of cadets of

each ROTC Units in Region VI, their performance level does not vary. This is due to the fact that each ROTC units exposed to the same instruction and curriculum content.

Table 8. Difference on the Performance of Cadets when grouped according to category

6. Modules in Teaching Military Science I & II shall be used as instructional manuals dur-

Aspects	School	n	Mean	t-value	p-value
Administrative Management	Public	13	23.78	0.354	0.558
	Private	11	23.67		
Tactical	Public	13	67.06	0.378	0.065
	Private	11	66.61		

Not Significant at 0.05  $\alpha$  level

ing the delivery of instruction among cadets of Region VI. For Module I, it will compose the major topics such as physical organization and orientation; military orientation; combat training of individual soldier; public information; Civil Affairs; and drills and ceremonies. For Module II, it will compose of general military subjects; small unit tactics; individual/ unit training; marksmanship; individual protective measures; familiarization firing; and basic obstacle course. Each module consists of the objectives, introduction, review, presentation of topic using the different strategies in teaching, discussion, drills, exercises, and evaluation of every subtopic of every major concept mentioned above. The cadets will be exposed to the various types of drills or exercises for the longer retention of the concepts.

This module will be devised to stimulate learning, guide the development of concepts or focus skills, elicit the message or meaning that cadets can take away from an activity and experience.

Aspects	Category	n	M	t-value	p-value
Administrative Management	"A" more than 350 cadets	16	23.72	0.562	0.462
	"B" less than 350 cadets	8	23.69		
Tactical	"A" more than 350 cadets	16	67.06	0.299	0.098
	"B" less than 350 cadets	8	67.26		

Not Significant at 0.05  $\alpha$  level

## CONCLUSIONS



The following conclusions were drawn based on the findings of the study:

1. The ROTC cadets in Region VI performed well during the Annual Administrative and Tactical Inspection. They have knowledge and skills in performing the different events.

2. The performance of cadets in administrative and tactical aspects does not vary during inspection when they were grouped according to school and category.

3. ROTC Units of Region VI need training aids and reference materials such as Module in Teaching Military Science I and II to enhance their knowledge especially in theoretical aspect.

### RECOMMENDATIONS

Based on the findings and conclusions, the following recommendations are drawn:

1. In view of the results of evaluation, it is highly recommended to every ROTC units of Region VI to procure the training aids and reference materials to be used during ROTC instruction.

2. Performance evaluation of ROTC instructors should be done every end of a semester to measure their competence in delivering instruction. This is one way of developing their teaching skills so that the cadets' performance will be improved.

3. Accommodation of professors as members of training staff is recommended so that the instruction will be comprehensively absorbed by the cadets. This is because professors know how to use the different methods of teaching that suit the learning style of the cadets.

### ACKNOWLEDGMENT

This study will not be possible, without the help and contribution of the following persons:

Lt. Col. Nelson L Trujillo, PA, researcher's husband for the untiring financial and moral support given until the completion of this paper.

Col. Pascual Luis D Bedia, PA, the group commander of 6RCDG for the approval to conduct this study in his area of operation.

Personnel of 6RCDG stationed in Dingle Headquarters and in 605<sup>th</sup> for the preparation of documents used in this study.

Carlos Hilado Memorial State College Research Personnel, for the continuous motivation and encouragement to pursue and finish this

endeavour.

Researcher's children, Neil, Neil Jun, Jonel, Leonel who always been the inspiration and love.

### REFERENCES

- Christensen, & Johnson (2012). *Educational Research (Quantitative, Qualitative, and Mixed Approaches) Fourth Edition*. United States of America: SAGE Publications, Inc.
- Dela Cruz, Sonia et al. (2010). *National Development via National Service Training Program (RA 9163)*. Mandaluyong City, Books Atbp. Publishing Corp.
- Edwards, Ellen (2012). *African American Student Retention in the ROTC Leadership Program*. Ann Arbor: ProQuest LLC.
- Hampton, Isaac II (2013). *The Black Officer Corps: A History of Black Military Advancement from Integration through Vietnam*. New York, Routledge.
- Farolan, Ramon (2013). *The ROTC Program and a Citizen Army*. Retrieved from <http://opinion.inquirer.net/56105/the-rotc-program-and-a-citizen-army-2>
- Funk, R (2002). *Developing Leaders Through High School Junior ROTC: Integrating Theory with Practice*. Retrieved from *Journal of Leadership & Organizational Studies*, [jlo.sagepub.com](http://jlo.sagepub.com).
- Principles And Methods Of Training (n.d.). Retrieved September 1, 2014 from <http://www.fao.org>.
- A New Approach To Leadership And Management (n.d.). Retrieved September 1, 2014 from <http://www.scribd.com>.
- Implementing Guidelines on NSTP-ROTC Component (2002). Retrieved August 31, 2014 from [http://www.army.mil.ph/Army\\_Sites/arescom/rotc\\_pages/his\\_rotc.htm](http://www.army.mil.ph/Army_Sites/arescom/rotc_pages/his_rotc.htm)
- Snyder, Lisa Gueldenzoph & Snyder, Mark J. (2008). *Teaching Critical Thinking and Problem Solving Skills*. *The Delta Pi Epsilon Journal*, 90-96.



# THE MTB-MLE IN THE FIELD OF INSTRUCTION: SNAPSHOT OBSERVATIONS AND REVIEW OF PRACTICES

**Andres T. Malinnag, Jr. Ed.D.**

Member: Corps of Professors, AFP  
Director, Administration and Finance  
North Luzon Philippines State College  
San Nicolas, City of Candon 2710  
malinnag.nlpssc@gmail.com

## ABSTRACT

*This paper was aimed to share teaching experiences for curriculum developers in general while the Department of Education of the Philippine government is doing collective endeavors toward the development of strong Mother Tongue-Base Multilingual Education (MTB-MLE) program. Following are concluded: as a beginning country advocating MTB-MLE, only one international training was given to teachers and supervisors at the time this research was conducted, few were selected to attend the training; the use of MTB-MLE was leveled “Almost Always Observed”. Teachers used “Iluko” in retelling English stories to pupils; relates lesson into a local setting; Iluko was used in giving instructions, in giving assignments; in getting attention of their pupils; in explaining lessons after their explanations in English or Filipino to reinforce themselves in the subject matter; used it when they ask questions to pupils; translated in Iluko the words that seemed unfamiliar in science and English subjects; translated in Iluko when pupils seemed not able to comprehend the lesson well; used Iluko when they are angry for emphasis. The acceptability of the MTB-MLE program was leveled to “almost highly acceptable” among the school administrators in the DepEd North District of Narvacan and Sta. Maria Districts of Ilocos Sur.*

Keywords: Mother Tongue-Base Multilingual Education (MTB-MLE).

## INTRODUCTION

The researcher is motivated to conduct this study because he is one of the faculty of Teacher Education of North Luzon Philippines State College (NLPSC); and member of the Corps of Professors of the Armed Forces of the Philippines. The regional tongue is *Iluko*; the language of the people of *amianan* (North).

The Philippines has more than 7,100 islands with more than 7,000 dialects. The country was colonized by the Spanish government for more than four centuries. So, from that view we could clearly understand that development of curriculum in the Philippines was greatly influenced by the Spanish people and culture. It is only in the southern Philippines more particularly in the Muslim Mindanao areas that native Philippine culture was considered to be preserved as evinced by their religion. Nevertheless, the Americans also influenced a bit in terms of discipline, socio-economic and political development including the use of English as a medium of instruction in the

southern Philippines. Generally, English language is used as medium of communication and instructions from North to Southern part of the Philippines. However, another development were contributed by the American (Western) people in our socio-economic and political life after the Spanish era. The Japanese also contributed significant negative influence to Philippine socio-economic and political growth considering the aftermath of WW II. The last that greatly contributed significant changes and influenced the Philippine Educational System are the Americans; and that means the medium of instruction is English.

By virtue of DepEd Order 74, series of 2009, the MTB-MLE program of the Department of Education was institutionalized, implemented in the lower grades (I, II, & III) for us to be benefitted with our own regional tongue and in order that pupils and teachers will have easier learning process.

## Statement of the Problems

The researchers would like to present the

following statement of the problems below:

1. What is the profile of the elementary schools in the DepEd North District of Narvacan, and Sta. Maria Districts of Ilocos Sur in terms of the following:

1.1 the number of elementary schools;

1.2 the number of teachers;

1.3 the number of pupils, and

1.4 the number of participants and number of teachers' training or orientation seminar concerning the MTB-MLE program?

2. What are the observed practices of the teachers concerning the use of MTB-MLE as perceived by their respective principals in the district?

3. What is the level of practices concerning the use of common Ilocano terms, phrases or expressions used by the teachers in teaching as coping mechanisms in instructions?

4. What is the level of acceptability of the use of MTB-MLE program in the district as perceived by the teachers and principals?

## METHODOLOGY

The researchers used the descriptive method of research. Similar to sociological type of research survey as mentioned by Aquino (1996), which states, "Sociological type includes a study of all human group relationships. The institutions of society are investigated (observed) with the purpose of furnishing recommendations for their improvement".

The **triangulation strategy** approach like using of the questionnaire for the data gathering, documenting snap and the conduct of unstructured interviews were used to strengthen the result of the study.

So, the researcher made a snap shot observation to two elementary schools and two different Districts of DEPED Ilocos Sur of Region I in the Philippines as subject of the study.

Video clips were also used for analysis relative to the demonstrated classroom teaching with a subject matter "Improving the Cursive Handwriting Performance Among the Grade VI Pupils using MTB-MLE". In other words, a teacher demonstrator was observed by the researcher and recorded the activities for analyses.

The researcher also used a questionnaire

in gathering pertinent data and to determine the level of practices concerning the use of common Ilocano terms, phrases or expressions used by the teachers in teaching as coping mechanisms in instructions; also the level of acceptability of the use of MTB-MLE program in the district as perceived by the teachers and principals.

The frequency count was used to establish the number of Elementary Schools, Teachers, and Pupils; and the mean was used to determine the level of practices and level of acceptability of the MTB-MLE.

## FINDINGS

The discussion of the results is a product of presentation of each of the problems with their corresponding gathered data in tabular form. Interpretations and analysis followed with statistical treatment of the data.

Table 1. The Profile Of The Two DEPED Districts of Narvacan and Sta. Maria, Ilocos Sur

There were 21 elementary schools, 140 teachers and 3,375 pupils; and one international training given entitled "1<sup>st</sup> MTB Multi-lingual Education International Conference in the Philippines 2011, held on January 18-20, 2011 to selected teachers and supervisors while in Sta. Maria District there were 19, 187, 3660 and 6 trainings respectively This implies that the limited number of participants who attended the training could signal a very weak support of the government or unfair distribution of slots among teachers. A total

DEPED Districts	ES	Teachers	Pupils	No. of Participants in Teachers' Training
North District Of Narvacan	21	140	3,375	2
Sta. Maria District	19	187	3,660	6
<b>Total</b>	<b>40</b>	<b>327</b>	<b>7,035</b>	<b>8</b>

of 40 Elementary Schools, 327 teachers, 7,035 pupils and eight trainings only.

Table 2. The Observed Practices of the Teachers Concerning the Use of MTB-MLE As Perceived by their Respective Principals

The teachers used MTB-MLE in retelling English stories to pupils; related lesson into a lo-

cal setting or materials that were familiar to pupils; used in giving instructions; used in giving assignments; used in getting attention of their pupils; used it in explaining lessons after their explanations in English or Filipino to reinforce themselves in the subject matter; used it when they asked questions to pupils; translated in *Iluko* the words that were unfamiliar to pupils especially in science and English subjects; translated in *Iluko* when pupils seemed not to comprehend the lesson

<b>The Observed Practices Of The Teachers With The Use Of MTB-MLE</b>
1. Retelling English stories to pupils.
2. Related lesson into a local setting or materials that were familiar to pupils.
3. Sometimes <i>Iluko</i> was used in aid/giving of instructions.
4. <i>Iluko</i> was used in giving assignments.
5. <i>Iluko</i> was used in getting attention of their pupils.
6. Use in explaining lessons after their explanations in English or Filipino to reinforce themselves in the subject matter.
7. Used when they asked questions to pupils.
8. Translate in <i>Iluko</i> the words that were unfamiliar to pupils especially in science and English subjects.
9. Translate in <i>Iluko</i> when pupils seemed not to comprehend the lesson well.
10. Used <i>Iluko</i> when they seemed angry at their pupils.

well; used *Iluko* when they seemed angry at their pupils. It implies that teachers are enjoying the use of MTB-MLE in teaching because they believed and felt that their pupils have no difficulty in understanding the lesson, stories and other instructions relevant to the subject matter.

Table 3. The Mean Level of Practices Concerning the Use Of Common Ilocano Terms, Phrases or Expressions Used by the Teachers

The following are: *Kastoy ti ...*(this is how to ...); *Kitaenyo man...*(Look at this...); *Sino ti umay ditoy...*(who will come); *Kitaek no matuladyo* ( I will see if you can follow); *Masurutanyo?* (can you follow?); *Sumarunokan!* (You are next!); and others like: *Naawatanyo/ natarusanyo* (understood?);, *Siasino ti adda saludsodna?*(any question?); *Nai-uloyo?* (is it in your head?); *Agtalnakayo!* (Pay attention!); *Kumustakayo?* (How are you?); *Masapula a sursurwen amin a banag...* (Learn everything!); *Garawkayo la a garaw...*!

(you are naughty); *Kastoy ti obraenyo...*(this is how you will work...); *Ania pay?* (Anything else?); *Adda pay mainayonyo?*(Anything more?);

<b>The <i>Iluko</i> terms, phrases or expressions used as coping mechanisms of teachers.</b>	<b>Mean (x)</b>	<b>Descriptive Level</b>
1. <i>Kastoy ne ...</i> (this is how to ...)	<b>3.86</b>	<i>Almost Always Observed</i>
2. <i>Denggenyo man / dumgegekayo...</i> (Listen class...)	<b>4.29</b>	<i>Always Observed</i>
3. <i>Kitaenyo man...</i> (Look at this...)	<b>4.00</b>	<i>Almost Always Observed</i>
4. <i>Sino ti umay ditoy...</i> (who will come)	<b>3.71</b>	<i>Almost Always Observed</i>
5. <i>Kitaek no matuladyo</i> ( I will see if you can follow)	<b>3.75</b>	<i>Almost Always Observed</i>
6. <i>Masurutanyo?</i> (can you follow?)	<b>4.45</b>	<i>Almost Always Observed</i>
7. <i>Nalpasen?</i> (Are you done?)	<b>4.49</b>	<i>Always Observed</i>
8. <i>Sumarunokan!</i> (You are next!)	<b>3.75</b>	<i>Almost Always Observed</i>
9. <i>Sinno ti saan a nakaawat?</i> ( Who among you did not understand?)	<b>4.57</b>	<i>Always Observed</i>
10.Others: <i>Naawatanyo/ natarusanyo?</i> (Understood?) <i>Siasino ti adda saludsodna?</i> (Who has a question?) <i>Naiyuloyo?</i> (You got it in your head?) <i>Agtalnakayo/ nakagaraw kayo!</i> (Pay attention!) <i>Kumustakayo?</i> (How are you?) <i>Sursuruen amin a banag...</i> (Learn everything...) <i>Garawkayo la a garaw...</i> (You are naughty...) <i>Kastoy ti obraenyo...</i> (This is how to work...) <i>Ania pay?</i> (Anything else?) <i>Adda pay panpanunot?</i> (Some more idea?) <i>Nagtangken ti uloyon!</i> (Hard headed?) <i>Sinno ti mayat a mangpadas?</i> (Who wants to try?) <i>Kadalusenyoy ti aramidyo, urnosen a nalaing...</i> (Make it neat and arrange carefully...)	<b>4.22</b>	<i>Almost Always Observed</i>

*Adda pay panpanunot?*(Any other idea?); *Nagtangken ti uloyon!* (Hard headed!); *Sinno ti mayat a mangpadas?* (Who will try?); and *Kadalusenyoy*

Legend: 4.26-5.00 - Always Observed  
3.45-4.25 - Almost always Observed

*ti aramidyo, urnosen a nalaing!* (Make it neat and arrange carefully). Likewise the table shows also items that has 4.26-5.00 or with a described level of “Always Observed”. The following are: *Denggenyo man /dumgegekayo...*(Listen class...); and *Sinno ti saan a nakaawat?* (Who among you could not understand?) It implies now that the *Iluko* terms or phrases or expressions used as coping mechanisms of teachers in the two DEPED District, Ilocos Sur has an impact when used in getting pupils attention.

Table 4. The Mean Level of Acceptability of the MTB-MLE Program

As shown on the table the level of acceptability of the MLE program as perceived by the teachers, head teachers and principals in the two DEPED districts of Ilocos Sur has a mean of 4.22 or leveled to “almost highly acceptable”. This means that teachers as well as their pupils are comfortable in the use of MTB-MLE program to increase the understanding of pupils’ lessons. Now, this also substantiates that previous studies states that the lessons and findings of various local initiatives and international studies in basic education have validated the superiority of the use of the learner’s mother tongue or first language in improving learning outcome promoting Education for all (EFA).

## CONCLUSIONS

Based from the findings the following were con-

	Teachers	Descriptive Level
Acceptability of the MTB-MLE program in the district as perceived by the teachers, Head Teachers and principals	4.22	<i>Almost Highly Acceptable</i>

Legend: 3.45-4.25-*Almost Highly Acceptable*

cluded:

1. Only few attended and only one training was given at the time this research was conducted. This means that equal opportunities were not given to DepEd teachers and supervisors.

2. The following were leveled “*Almost Always Observed*”: *Kastoy ne ...*(this is how to

...); *Kitaenyo man...*(Look at this...); *Sino ti umay ditoy...*(who will come); *Kitaek no matuladyo* ( I will see if you can follow); *Masurutanyo?* (can you follow?); *Sumarunokan!* (You are next!); *Sumarunokan!* (You are next!); and others like: *Naawatanyo/ natarusanyo* (understood?);, *Siasino ti adda saludsodna?*(any question?); *Nai-uloyo?* (is it in your head?); *Agtalnakayo!* (Pay attention!); *Kumustakayo?* (How are you?); *Masapula a sursurwen amin a banag...* (Learn everything!); *Garawkayo la a garaw...!* (you are naughty); *Kastoy ti ubraenyo...*(this is how you will work...); *Ania pay?* (Anything else?); *Adda pay mainayonyo?*(Anything more?); *Adda pay panpanunot?*(Any other idea?); *Nagtangkeng ti uloyon!* (*Hard headed!*); *Sinno ti mayat a mangpadas?* (*Who will try?*); and *Kadalusenyoy ti aramidyo, urnosen a nalaing!* (Make it neat and arrange carefully). Also the following were leveled “Always Observed”: *Denggenyo man / dumgegekayo...*(Listen class...); and *Sinno ti saan a nakaawat?* (Who among you could not understand?) This means that the use of MTB-MLE in Narvacan North and Sta. Maria Districts of the Department of Education was “almost always observed”.

3.The teachers used MTB-MLE in retelling English stories to pupils; related lesson into a local setting or materials that were familiar to pupils; *Iluko* in giving instructions; used *Iluko* in giving assignments; used *Iluko* in getting attention of their pupils; used the MTB-MLE in explaining lessons after their explanations in English or Filipino to reinforce themselves in the subject matter; used MTB-MLE when they asked questions to pupils; translate in *Iluko* the words that are unfamiliar to pupils especially in science and English subjects; translate in *Iluko* when pupils seemed not to comprehend the lesson well; used *Iluko* when they were angry at their pupil. The acceptability of the MTB-MLE program was leveled to “almost highly acceptable” as perceived by the teachers, head teachers and principals. This means that teachers as well as their pupils are comfortable in the use of MTB-MLE program to increase the understanding of pupils’ lessons.

Now, this research output also substantiates that previous studies which states that findings of various local initiatives and international studies in basic education have validated the superiority of the use of the learner’s mother tongue or first language in improving learning outcome promoting Education for All (EFA).

This paper may also enlightened stakeholders not to doubt that MTB-MLE program the Department of Education; eventually all of us will appreciate the mother tongue because it will serve as catalyst to our culture and ease difficulties in instruction.

## RECOMMENDATIONS

Based from the findings and conclusions of the study, the following recommendations are advanced by the researcher:

1. More teachers' training should be given concerning MTB-MLE.

*To do this:*

1.1 More budget concerning this MTB-MLE training be appropriated by DEPED officials from the division;

1.2 Equal opportunity and proper distribution of training to teachers and supervisors be practiced;

2. Adopt the observed practices of the teachers concerning the use of MTB-MLE as perceived by their respective principals in the district; also adopt the practices concerning the use of common Ilocano "iluko" terms, phrases or expressions used by the teachers in teaching as coping mechanisms in instructions are also encouraged to be improved.

3. Adopt without doubts that this MTB-MLE Program is a good tool as coping mechanism in the field of instruction. The level of acceptability of the MTB-MLE program in the two districts was leveled to *Almost Highly Acceptable*; thus, this is highly recommended.

4. Impact assessment should be studied after five years (or after their graduation in **elementary school or college**) to follow-up the outcome of this pilot program of the Department of Education in the Philippines.

5. Implications for other international researchers:

5.1 It is also advanced that other studies be conducted in other areas concerning MTB-MLE program of the government in order to monitor progress of the program like development of books and other instructional materials including state of the art facilities.

5.2 It is also advanced by the researcher that a collaboration study be conducted to other third world countries.

## ACKNOWLEDGMENT

The author wished to acknowledge the assistance of two friends from the DepEd Districts of Narvacan and Sta. Maria headed by Mrs. Isanie K. Collo (Principal) and Dr. Avelina D. Gatdula, (District Supervisor), former fellow faculty Mr. Ausbert Felicitas, UNP; and R & E Dir. Severino G. Alviento.

Also, he wish to thank Dr. Elizabeth M Gacusana, SUC President I, for her usual support.

## REFERENCES

### A. Books

De Leon, Hector S. (1997) *The 1987 Philippine constitution*, Manila, Philippines: Rex Bookstore.

Panopio, Isabel S et.al (1994). General sociology: Focus on the Philippines. 3<sup>rd</sup> Edition. Manila: Ken Inc.

Vega, Violeta A. et. al. (2006) Social dimensions in education, Cubao, Quezon City: Lorimar Publishing, Inc.

### B. Unpublished Materials

Abuan, *Caridad O* (2011), Message to the 1<sup>st</sup> Mother Tongue-Based Multi-lingual Education International Conference, Urdaneta City University (UCV), Pangasinan, Philippines.

### C. Websites:

[www.edexchange.org/multicultural](http://www.edexchange.org/multicultural)

[www.undp.org/gender/crisis](http://www.undp.org/gender/crisis)

### D. Others: *Government Documents:*

DepEd Order 74, series of 2009.

DepED Order No. 60, s. 2008.

Nolasco, Ricardo Ma. Duran (2009), MLE Primer.

Pacific Islands Discussion Paper Series, 1995.

Torregoza, Hanna, Manila Bulletin, April 20, 2011.

UNESCO Bangkok, 2005.

# LOW VOLTAGE AND HIGH EFFICIENCY DC-DC BOOST CONVERTER DESIGN FOR HEAT WASTE THERMAL TO ELECTRICAL ENERGY CONVERSION

**Engr. Gillert M. Bongcac, MoE**  
Jose Rizal Memorial State University  
Main Campus, Dapitan City, Philippines  
phyton\_gil@yahoo.com

## ABSTRACT

*This study presents a high efficiency DC-DC boost converter for low voltage input heat waste thermal source. The design is modeled and simulated using MultiSim and verified using actual experiment. The design can effectively operate from 0.57V to a maximum of 0.96V. The operating temperature difference of the TEG is between 37°C to 47°C with the power efficiency of 95.31% to 158.90%. The maximum output voltage of the converter design is maintained at 5.23V. The result shows that the design is capable to boost small voltage to higher voltage with very high power efficiency.*

## INTRODUCTION

Renewable energy resources now become the center of interest in most of the studies. Thermoelectric power generation has the advantage for having no moving or complex parts in the operation and is maintenance free. In improve the efficiency of the thermal energy harnessing system; this paper proposes the usage of DC-DC boost converter for the production of higher power. A DC-DC boost converter is capable of boosting a low input power into much higher. This topic draw much attention due of its wide variety of application and availability.

A new series of DC-DC boost converter topologies are proposed. The topologies use voltage lift technique to obtain higher output voltage than the classical boost converter for the same duty ratio. The technique also overcomes the effect of parasitic elements and minimizes the ripple in the output voltage. A simplified controller with one sensor is designed to maintain the output voltage at the required level for the load and line disturbances (Sanjeevikumar & Rajambal, 2008). To obtain high efficiency, the inductor winding resistance  $R_L$  should be much smaller than  $(1 - D) 2R$ . This is much easier to accomplish at low duty cycles, where  $(1 - D)$  is close to unity, that at high duty cycles where  $(1 - D)$  approaches zero. Consequently, the efficiency is high at low duty cycles, but decreases rapidly to zero near  $D = 1$ . This behavior is typical of con-

verters having boost or buck-boost characteristics (Erickson, 2009).

The PFM boost converter with a small power MOS has a high power efficiency under light loads, but it cannot supply a large current for heavy loads (Chen et. al., 2013). Traditional DC-DC boost converters are used in high-voltage applications, but they are not economical due to the limited output voltage and efficiency because they require more sensors with complex control algorithm. Moreover, due to the effect of parasitic elements the output voltage and power transfer, efficiency of DC-DC converters are limited (Sanjeevikumar & Rajambal, 2008).

This paper proposes the usage of DC-DC boost converter for the production of higher voltage output for a more efficient system. Proper component selection and PCB layout make a significant difference in the parasitic losses that occur.

## Statement of the problem

DC-DC boost converter steps up DC voltage for an efficient system. It is the combination of active electronic elements that provides a DC voltage step up and the combination of passive elements acts as a filter to reduce ripples. The ideal dc-dc converter exhibits 100% efficiency; in practice, efficiencies of 70% to 95% are typically obtained (Erickson, 2009).



Since power must be conserved, the output current is lower than the source current (Tushar, 2015). Moreover, due to the effect of parasitic elements, the output voltage and power transfer efficiency of DC-DC boost converters are limited (Sanjeevikumar & Rajambal, 2008). The thermoelectric generator (TEG) output voltage is low, so the a boost converter is needed to amplify its voltage and increase the power output.

This paper designs a DC-DC boost converter to step up voltage with high power efficiency. Generated voltage from the TEG is boosted to attain the stepped up desired output.

### Objectives

1. Design a high efficiency and low voltage DC-DC boost converter for thermoelectric generator using thermal heat waste.
2. Evaluate the amplification characteristics and efficiency of the DC-DC boost converter.
3. Verify the harnessing of thermal heat, energy conversion process and the boosting of the design using different simulated waste heat input.

### Significance

This study will have great impact in reduction of global warming since the waste heat will no longer be dump to the environment. Waste heat will be harnessed and converted to useful electrical energy. The designed DC-DC boost converter steps up and amplifies a low voltage electrical output of the thermoelectric generator with a high efficiency output voltage. This design can produce sufficient electric voltage with a minimal waste heat temperature.

### Theoretical/conceptual framework

#### 1. Thermoelectric generator

2.

Thermoelectric generator (TEG) is a device that converts thermal energy directly into electrical energy. A typical TEG structure is shown in Figure 1. Early TEG devices utilize metallic TE material, whereas more recently manufactured TEGs use alternating n- and p-type semiconductor materials. The TEG structure is "sandwich like", with thermoelectric materials "sandwiched" by two heat exchanger plates at its two ends respectively. One of the two exchangers has high temperature, and hence, it is called the

hot side of the TEG; while the other has low temperature and is called the cold side of the TEG. There are electrical-insulate-thermal-conductive layers between the metal heat exchangers and the TE material. The two ends of n- and p-type legs are electrically connected by metal.

The thermal-electrical conversion is done by a phenomenon generally referred to as "Seebeck effect. TEGs are solid-state device, which means that they have no moving parts during their operations. Together with features that they produce no noise and involve no harmful agents, they are the most widely adopted devices for waste heat recovery. (Li M., 2011)

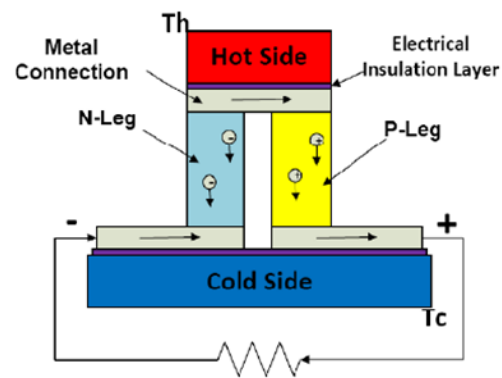

Figure 1. Typical TEG structure

### 2. The boost converter

A boost converter (step-up converter) is a power converter with an output DC voltage greater than its input DC voltage. It is a class of switching mode power supply (SMPS) containing at least two semi-conductors switches (a diode and a transistor) and at least one energy storage element. Filters made of capacitors (sometimes in combination with inductors) are normally added to the output of the converter to reduce output voltage ripple. A boost converter is sometimes called a step-up converter since it "steps up" the source voltage. Since power ( $P = VI$ ) must be conserved, the output current is lower than the source current.

The boost converter has the same components as the buck converter, but this converter produces an output voltage greater than the source. "Boost" converters start their voltage conversion with a current flowing through the inductor (switch is closed). current flowing through the

the inductor (switch is closed). Then they close the switch leaving the current no other path to go than through a diode (functions as one way valve) The current then wants to slow really fast and the only way it can do this is by increasing its voltage (akin to pressure) at the end that connects to the diode, and switch. If the voltage is high enough it opens the diode, and one through the diode, the current can't flow back. This is the very basic concept of boost converter.

### 3. Operating principle of boost converter

The key principle that drives the boost converter is the tendency of an inductor to resist changes in current. When being charged it acts as a load and absorbs energy (somewhat like a resistor); when being discharged it acts as an energy source (somewhat like a battery). The voltage it produces during the discharge phase is related to the rate of change of current, and not to the original charging voltage, thus allowing different input and output voltages. Because the switch is on and off so fast, the inductors magnetic field never fully collapses, so when the switch is opened again, this causes a higher voltage on the inductor as it adds to the magnetic field (See Figure 2).

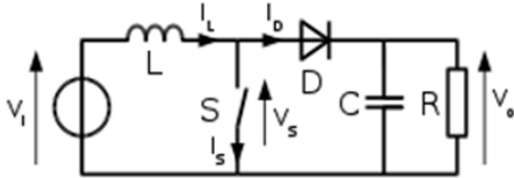

Figure 2. Boost Converter Schematic

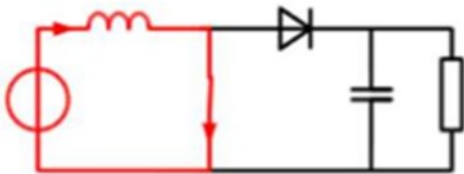

Figure 3. On state of converter

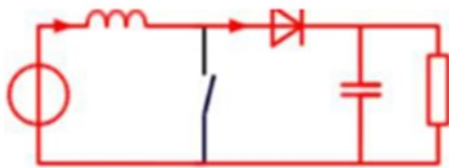

Figure 4. Off state of converter

### 4. Continuous mode

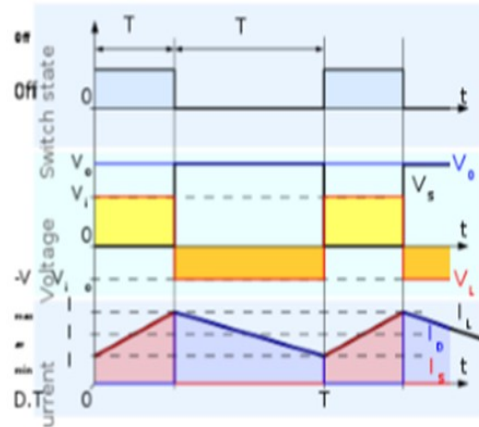

Figure 5. Waveforms of current and voltage in a boost converter operating in continuous mode.

When a boost converter operates in continuous mode, the current through the inductor ( $I_L$ ) never falls to zero. Figure 4 shows the typical waveforms of currents and voltages in a converter operating in this mode.

During the On-state, the switch S is closed, which makes the input voltage ( $V_i$ ) appear across the inductor, which causes a change in current ( $I_L$ ) flowing through the inductor during a time period ( $t$ ).

### 5. Discontinuous mode

In some cases, the amount of energy required by the load is small enough to be transferred in a time smaller than the whole commutation period. In this case, the current through the inductor falls to zero during part of the period. The only difference in the principle described above is that the inductor is completely discharged at the end of the commutation cycle.

### 6. Efficiency in a DC-DC Converter

There are many sources of loss in a DC-DC converter that reduce the efficiency of the system. These losses can be divided into two basic groups: efficiency losses caused by peak inductor current; and switching losses that occur each time that the circuit switches from charging to discharging phases.

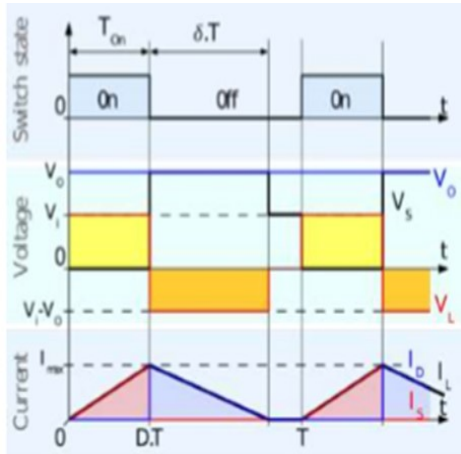

Figure 6. Waveforms of current and voltage in a boost converter operating in discontinuous mode.

There are three main sources of efficiency loss caused by inductor current. The two most significant sources are the drain-to-source resistance of the transistor when it is conducting, and the DC resistance of the inductor. Both of these actions add resistance in series with the inductor. These resistances consume input power and decrease the voltage across the inductor during the charging phase. When the inductor discharges through the diode, power loss proportional to the inductor current also occurs.

Switching losses occur during each cycle of the DC-DC converter. The most obvious switching losses are caused by parasitic capacitance in the circuit. Each time the inductor is discharged through the diode, the node at the anode of the diode needs to be charged to a voltage level greater than  $V_{out}$ . This node also has the transistor's drain-to-source capacitance and the capacitance of the anode that both need to be charged before diode conduction can begin.

There are other sources of switching loss. Switching loss occurs at the beginning of each charging cycle when the transistor's gate capacitance needs to be charged before the transistor will turn on. Core loss in the inductor is another source of energy loss. As the switching frequency increases, so do the core losses in the inductor. The magnitude of these losses depends on inductor core material and size. Switching losses also occur during the reverse recovery time of the diode. During this time, charge that has been stored at the output is

allowed to flow through the inductor (Erickson, 2009)

## METHODOLOGY

This chapter contains collecting and processing of information and data about in this study. It also includes the design setup, formulation and implementation to get the necessary data needed for the study of DC-DC boost converter.

### Research Design

For this study, experimental research design is applied. Previous studies on dc to dc booster uses PFM, MOSFET and 555 timer as the power switch. In this study, the IC with PWM switch is used. To minimize power loss when the diode is conducting, the forward voltage should be as small as possible. Physical size of the inductor should be considered in order to lower the DC resistance.

### Research Strategy

The research strategy used is quantitative wherein variables are determined. The dependent and independent variables are analyzed and evaluated. For the thermal energy harnessing the dependent variables are the voltage and current output from the dc to dc booster while the independent variables are the power input of the TEG.

### Data Collection and Analysis

The performance of the system will be tested to gather the data needed on determining the efficiency of the system. For the designing of the system specifications of different component is defined. Collection of data are performed at different input voltages. The results will be tabulated and analyzed to determine the efficiency of the system.

Data like voltage and current from the output of TEG; and from the generated output from the DC-DC boost converter will be measured and collected duration the conduct of experiment. These data are obtained using a digital multi-tester.

### Diode Selection

Four parameters must be considered when selecting a diode for a DC-DC converter applica-

application. First, the reverse breakdown voltage of the diode must be greater than the voltage at the output of the converter. Second, the diode must be able to operate with the forward current that will be pushed through the diode by the inductor. Third, to minimize power loss when the diode is conducting, the forward voltage should be as small as possible. Some applications may even use Schottky diodes because they have a much lower forward voltage. Finally, choosing a diode with a short reverse-recovery time will limit the output charge lost back to the input when the diode switches from the conducting to the non-conducting stage.

### Inductor Selection

When selecting the inductor for a DC-DC converter, three parameters should be considered. First, the most critical parameter is the saturation current of the inductor. If the saturation current of the inductor is less than the converter's required peak current, then the converter will not be able to supply the necessary output power. Second, the designer must consider the DC resistance of the inductor.

Finally, the physical size of the inductor should be considered. In order to lower the DC resistance, an inductor in a larger package could be considered if the physical size of the inductor is not prohibitive.

### Research Method

The DC-DC boost converter is connected to TEG, generated voltage and current from the TEG are measured through multimeter. DC-DC boost converter then steps up the generated power from the TEG. The design will be implemented and the results will be tabulated.

### Procedural Set-up

The TEG is sandwiched between a heat sink with water to maintain the room temperature in cold side and flat iron on its hot side. The temperature is measured using digital thermometer. The cold side of the TEG is maintain at room temperature while the hot side is varied. The output voltage and current depends upon the heat difference between the cold and hot side of the TEG. The generated voltage and current of the TEG is measured using multimeter.

The input voltage and current of the DC-DC booster is the output generated from the TEG. The output voltage and current of the booster is measured using multimeter.

To solve the efficiency, power input and power output of the booster is calculated. Power is equal to the product of the voltage and current. The efficiency ( $\eta$ ) of the system is equal to the quotient of the input ( $P_{in}$ ) and output power ( $P_{out}$ ) of the booster

$$\left( \eta = \frac{P_{out}}{P_{in}} \right)$$

## RESULTS AND DISCUSSIONS

### Modeling

The design DC-DC boost converter as shown in figure 7 is model using multisim.

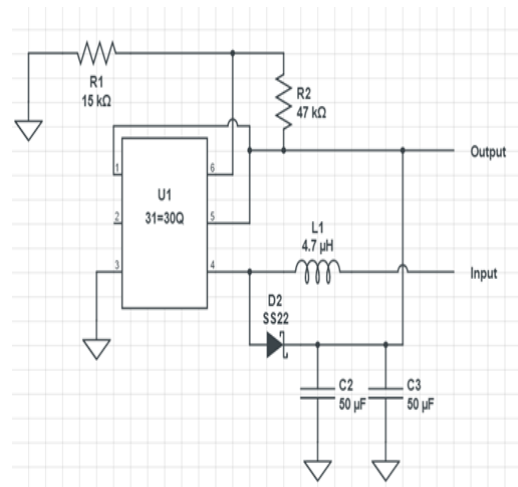

Figure 7. Model of a DC-DC boost converter

The TEG is connected to the DC-DC boost converter. The output from the TEG is the input of the circuit.

### Mode of operation

When the switch is on, the current in the inductor rises while on the off-stage, the current collapses but does it not fall to zero. The cycle continues as the switch is on and off. The control technique in switching the inductor is PWM (Pulse-width Modulation. The frequency is held constant or fix at 475 kHz with a duty cycle of 85%.

The figure 8 shows the actual design of the DC to DC boost converter. The red wire (left side) is the input of the booster and the black wire is the ground. The TEG is connected to the input of the booster.

The clamp multimeter is an electrical tester that combines a voltmeter with a clamp type current meter. This multimeter also measure temperature at degree Celsius and degree Fahrenheit. This is used to measure the temperature at the cold and hot side of the TEG.

### Actual Design

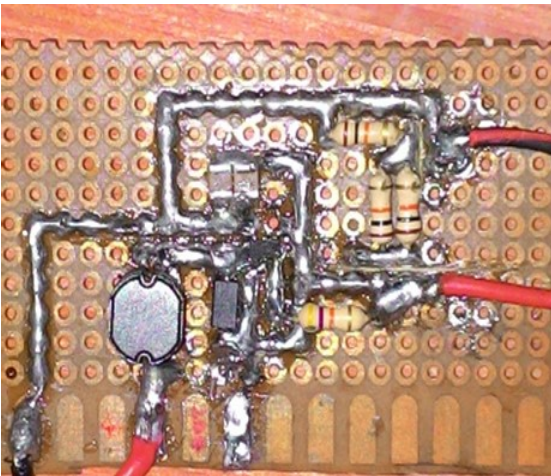

Figure 8. DC to DC Boost Converters

### Actual experimental setup

The TEG is sandwich between a molder and a thin-cut Heat sink. The TEG serves as the power input to the DC to DC boost converter. The paste used between the molder, the thin-cut Heat sink and the TEG is a silicon compound. Single TEG is connected in parallel with the DC to DC boost converter. DC to DC boost converter at room temperature.

The figure 9 shows the booster is connected in parallel with the TEG. The TEG is sandwich between the molder and the thin-cut Heat sink. The molder is added with water at room temperature as the cold side of the TEG. The paste used between the TEG, the thin-cut Heat sink and the molder is silicon compound.

Table 1. Efficiency of the design system

TEMPERATURE (°C)	TEC1 – 12705 (TEG)			BOOSTER			EFFICIENCY (%)
	Volt (V)	Current (A)	Power (W)	Volt (V)	Current (A)	Power (W)	
25.2	0.00	0.00	0.00	0.00	0.00	0.00	2.686
80.2	0.0569	0.0423	0.235	4.05	0.0164	0.0663	
26.2	0.00	0.00	0.00	5.00	0.00	0.00	38.43
80.7	0.0577	0.0434	0.247	2.10	0.0123	0.052	
26.3	0.00	0.00	0.00	5.00	0.00	0.00	90.51
85.7	0.0757	0.0672	0.507	2.21	0.0448	0.098	
27.4	0.00	0.00	0.00	5.00	0.00	0.00	83.05
80.2	0.0831	0.0676	0.558	3.14	0.0421	0.169	
27.4	0.00	0.00	0.00	5.00	0.00	0.00	88.86
85.7	0.0986	0.0889	0.876	3.17	0.0595	0.205	
28.5	0.00	0.00	0.00	5.00	0.00	0.00	76.87
80.2	0.1041	0.0803	0.841	3.17	0.0595	0.205	
28.5	0.00	0.00	0.00	5.00	0.00	0.00	66.80
85.7	0.0707	0.0720	0.507	2.00	0.00	0.00	

The table 1 shows the results of the output power from the TEG and the output power from the booster. The DC-DC boost converter will operate when the required input voltage is met. This input voltage of the converter is dependent on the output voltage of the TEG.



**Figure 9.** DC to DC boost converter application with TEG at room temperature.

## CONCLUSIONS AND RECOMMENDATIONS

### CONCLUSION

The highest efficiency is 90.51%. This occurs at 37 °C difference of temperature. The DC-DC boost converter can operate at highest efficiency rating in the range of 37°C – 47°C. As shown in the results, the DC-DC boost converter can effectively operate at a specified difference temperature. Below and above the effective operating temperature, the efficiency of the design will deteriorate. Therefore, it is best to monitor and control the temperature difference of the cold and hot side of the TEG in order to maintain high efficient power output.

### RECOMMENDATION

1. Use a different control technique on switching the inductor. Use PFM (pulse-frequency modulation) wherein it operates with a fixed pulse on-time (or off-time) and performs control by varying the off-time (or on-time).
2. Add storage device in order to stabilized the output voltage of the TEG.

3. Consider the factors in testing, like the air temperature and the heat sink design materials for absorptions and dissipation of heat in the cold side of the TEG.

## REFERENCES

- Chen H, Chang R., & Lin K. (2013). A High-Efficiency Monolithic DC-DC PFM Boost Converter with Parallel Power MOS Technique. Retrieved from <https://www.hindawi.com/journals/vlsi/2013/643293/>
- Erickson R. W. (2009). DC-DC Power Converters. Retrieved from [http://www.eng.auburn.edu/agrawd/COURSE/READING/LOWP/Eriks\\_on\\_DC\\_2\\_DC.pdf](http://www.eng.auburn.edu/agrawd/COURSE/READING/LOWP/Eriks_on_DC_2_DC.pdf)
- Fathah A. (2013). Design of a Boost Converter. Retrieved from <http://ethesis.nitrkl.ac.in/4811/1/109EE0612.pdf>
- Inam W., et. al. (2014). High Efficiency Resonant dc/dc Converter Utilizing a Resistance Compression Network. Retrieved from [http://www.rle.mit.edu/per/wp\\_content/uploads/2014/04/Inam-High-Efficiency-APEC.pdf](http://www.rle.mit.edu/per/wp_content/uploads/2014/04/Inam-High-Efficiency-APEC.pdf)
- Li M., (2011). Thermoelectric-Generator-Based DC-DC Conversion Network for Automotive Applications. Retrieved from <http://www.diva-portal.org/smash/get/diva2:446877/FULLTEXT01.pdf>
- Maxim Integrated (2012). How to Design an Efficient DC-DC Converter Using the DS1875 PWM Controller. Retrieved from <https://www.maximintegrated.com/en/app-notes/index.mvp/id/4332>
- Mustapha N. A. C., et. al. (2014). A DC-DC Circuit Using Boost Converter for Low Voltage Energy Harvesting
- Sridhar P. & Arulkumar P. M. (2014). An Efficient Single-Input Multiple Output Power supply using DC-DC Boost Converter. Retrieved from <https://www.hindawi.com/journals/mse/2008/593042/>
- Suresh P. V., et. al. (2014). Review on High Gain DC/DC converters for Renewable Energy Applications and their Comparison with Proposed Converter. Retrieved from <http://www.warse.org/IJETER/static/pdf/Issue/>
- Parmar M. N. & Jotangiya V. G. (2014). Step-Up DC-DC Converter with High Voltage Gain Using Switched-Inductor Tech-

- Technique. Retrieved from <https://www.ijedr.org/papers/IJEDRCP1401009.pdf>
- Rafis H. et. al., (2013). Design of DC-DC Boost Converter with Thermoelectric Power Source. Retrieved from [https://www.ijareeie.com/upload/2013/september/1\\_DESIGN.pdf](https://www.ijareeie.com/upload/2013/september/1_DESIGN.pdf)
- Sanjeevikumar P. & Rajambal K. (2008). Extra-High-Voltage DC-DC Boost Converters Topology with Simple Control Strategy.

# MAXIMUM POTENTIAL ENERGY PRODUCED THROUGH HEAT DISSIPATION OF THE MICROPROCESSOR HEATSINK

**Engr. Gillert M. Bongcac, MoE**

Jose Rizal Memorial State University  
Dipolog Campus, Dipolog City, Philippines  
phyton\_gil@yahoo.com

## ABSTRACT

*In this study, the potential energy produced through harnessing the thermal energy produced by the heatsink in the microprocessor was evaluated. In the computer system, the heat generated by the microprocessor is a thermal form of energy. This thermal energy will be harness to be converted into an electrical energy to supply the peripheral parts of the computer system. These electrical characteristics are bases for establishing the based parameter to determine the design specification of the research program project. The thermal energy dissipated by the microprocessor was randomly measured through experiment to determine the maximum potential energy that can be converted to supply the peripheral of the computer system. The results yielded that there are no effect on the temperature of the different brand of microprocessor to the potential energy produced by the thermoelectric generator and that the thermal energy dissipated by the microprocessor are sufficient enough to produced electrical energy to power-up a low powered electronic components.*

Keywords: Potential energy of microprocessor, Heat dissipation of microprocessor heatsink, Electrical energy produced through TEG conversion

## INTRODUCTION

The alternative power source program research project will harness the thermal energy of the microprocessor using thermoelectric generator (TEG). The electrical energy output of the TEG will be amplified using amplifier and then stored to the voltage storage unit using battery. If the stored voltage is sufficient enough to supply the peripheral of the computer, the static transfer switch will transfer from the external DC voltage source to the voltage source generated by the thermal energy.

The first phase of the program research project is to identify the design specification of the said project. This design specification will be obtained using experimental study of the thermal dissipation by the microprocessor in the computer system. The dissipated thermal energy of the microprocessor varies depending on the following; the usage of the microprocessor, the algorithmic complexity of the program that is running, the architectural setup of the system, and the thermal heatsink design [Sankaranarayanan, 2009]. The results of the experiment will be the bases for the formulation of the design specification of the whole project. The data collected in this experiment will yield four research studies. These studies are (1) Maximum potential

electrical energy produce by peltier device in relation to different location of thermoelectric generator and different brand of microprocessor , (2) Analysis of heat losses of different computer system setup, (3) Heat production in relation to algorithmic complexity, and (4) Sensible heat transmission of the TEG in relation to the different type microprocessor and heatsink.

This research study will focus on the effect of different brand of microprocessor and location of peltier device in relation to maximum potential electrical energy produce by the TEG.

### Objectives

This study aims to

- a. Perform an experimental study to determine the based parameters of the temperature dissipated by different microprocessor in order to formulate a design specification of the whole research program project.
- b. Determine the effect of different brand of microprocessor and location of the peltier device in relation to the potential energy produced by the TEG.
- c. Evaluate the stability and sustainability of the electrical energy produce by the TEG.



## Significance of the Study

By evaluating the stability and sustainability of the potential electrical energy produce by the TEG through thermal dissipation of the microprocessor, the researcher can determine the feasibility of the thermal energy produced by the microprocessor to be converted to electrical energy to supply the peripheral parts of the computer system or if properly treated it can lead to a self-sustaining energy system for the computer system.

## Scope and Limitation

The gathering of data in the establishment of the base parameters is done in a controlled environment. The data will be extracted using old and new computers. Intel processors are the only brands of computer processors that will be used in the study.

## RESEARCH DESIGN AND METHODS

This research study uses experimental analysis to establish the based parameter. The results will be used to decide the design specification of the entire project. The experimental study utilized four (4) Intel brand processor computers.

Games and graphics application program are run in the computers and the thermal energy produced by the microprocessor and the heat sink was randomly monitored and measured using Digital Clamp Meter UT202 Contact Temperature Probe. The measured data's of the microprocessor and the heat sink are process using the Seebeck Thermoelectric Generator 1261G-7L31-O4CQ data sheets and are interpolated to determine the corresponding electrical characteristics.

Also, Equality of variance for the effect of different brand of processor is determined using Analysis of Variance (ANOVA).

## Design Flowchart

Table 1: Different Processor and Heat Sink Temperature

Processor	Measurements	Maximum CPU Temperature (°C)	Heat Sink Temperature (°C)
Processor 1: Intel Core 2 1.8Ghz	1	60	38
	2	70	40
	3	71	39
	4	71	39
	5	71	40
Processor 2: Intel Dual Core 2.6Ghz	1	50	37
	2	55	37
	3	55	37
	4	55	36
	5	55	37
Processor 3: Intel Core i3 3.07Ghz	1	48	39
	2	56	38
	3	56	39
	4	63	39
	5	62	41
Processor 4: Intel Core i5 3.2Ghz	1	60	39
	2	60	39
	3	60	39
	4	60	40
	5	60	40

Table 2: TEG Electrical Characteristics

Processors	Average CPU Temperature (°C)	Average Heat Sink Temperature (°C)	Voltage Output by TEG (Volt)	Current Output by TEG (Ampere)	Power(W) Output by TEG (Watt)
Intel Core 2 1.8Ghz	68.6	39.2	0.662	0.242	0.160
Intel Dual Core 2.6Ghz	54	36.8	0.364	0.145	0.053
Intel Core i3 3.07Ghz	57	39.2	0.366	0.152	0.056
Intel Core i5 3.2Ghz	60	39.4	0.448	0.165	0.074

The effect of different temperature processor was examined using radar graph as showed in figure 3. The pattern shows that the processor temperature in the first measurements is low compare to the rest of the measurements.

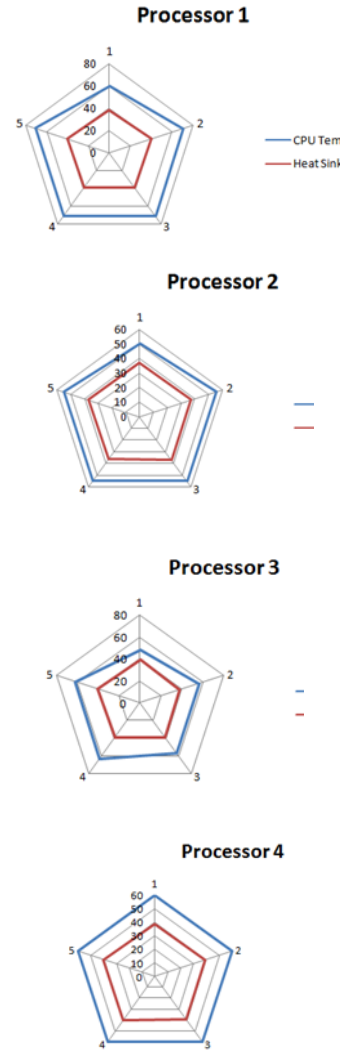

Table 3: One-way ANOVA Model

Processor	Tes t1	Tes t2	Tes t3	Tes t4	Tes t5	T <sup>1</sup>	T <sup>2</sup>	T <sup>3</sup>	T <sup>4</sup>	T <sup>5</sup>
1	60	70	71	71	71	3600	4900	5041	5041	5041
2	50	55	55	55	55	2500	3025	3025	3025	3025
3	48	56	56	63	62	2304	3136	3136	3969	3969
4	60	60	60	60	60	3600	3600	3600	3600	3600
Total	218	241	242	249	249	1204	1461	1482	1565	1565

**Testing the Effect of different Brand of Processor**

The data's in table 1 was used to determine the significance of variance. The computed results are tabulated in Table 3 and Table 4.

Figure 3: Radar Graph of Temperature of the Different Processor

$$\text{Sum of } X (\sum x) = 1,199$$

$$\text{Sum of } X^2 (\sum x^2) = 72,737$$

$$\text{Total Sum of Square (TSS)} = \sum x^2 - \frac{(\sum x)^2}{N} = 72,737 - \frac{(1199)^2}{20} = 856.95$$

$$\text{Sum of Square between column (SSb)} =$$

Table 4: ANOVA Table

Source of Variation	Sum of Square (SS)	Degrees of Freedom(df)	MSS = SS/df	F
SSb	162.7	4	40.67	0.87
SSw	694.25	15	46.2833	
Total	856.95	19		

### CONCLUSIONS

Based on the simulated results obtained, the following findings are obtained;

1. At 99% level of significance, the tabulated value is 4.89, since the computed value (0.8788) is less than the tabulated value; therefore there is no effect on the temperature of the different brand of processor in relation to the potential energy produced by TEG.
2. The temperature difference of the hot side and the cold side of the TEG is directly proportional to the voltage and current output of the device.
3. The thermal energy dissipated by the processor can be harness using TEG to produce an electrical energy.
4. The starting temperature of the processor is very low which makes it insufficient to produced electrical energy conversion.

The researcher concluded that the thermal energy dissipated by the processor are sufficient enough to produced electrical energy to power-up low powered electronic components in the computer system.

### REFERENCES

- Cahoon, Curtis Wayne, *Low Voltage CMOS Temperature Sensor Design using Schottky Diode based References*, Boise State University, 2008.
- Li, Yiran, *CMOS Device and Circuit Technology for On-Chip SMART Technology Sensor*, Texas Tech University, 2012.

Linear Technology, Temperature-to-Voltage Converter Measures Remote Diodes with 1°C Accuracy

Pires, Nelson Paulo Vitorino, *Integrated Thermal Monitor for SOC*, Instituto Superior Tecnico 2007

Sankaranarayanan, Karthik. *Thermal Modeling and Management of Microprocessor*, University of Virginia, May 2009.

Seebeck Thermoelectric Generator, Part Number: 1261G-7L31-04CQ, Custom Thermoelectric, TEG Specification sheet.

Valle, Bruno Do, *An area and power-efficient Analog Li-Ion Battery Charger Circuit*, IEEE transaction of Biometric Circuits and Systems, Vol. 5 No. 2., 2011.



# FINANCIAL PERFORMANCE OF CATANDUANES STATE UNIVERSITY MULTI-PURPOSE COOPERATIVE MICROFINANCING SERVICES: A CASE STUDY

**Maria Isabel L. de la Hostria, MBA**

CBA Extension Coordinator  
College of Business and Accountancy (CBA)  
Catanduanes State University  
Virac, Catanduanes, Philippines  
bel061280@yahoo.com.ph

## ABSTRACT

*This study was conducted to specifically analyze the performance of the cooperative's microfinancing services from 2010 to 2014 in terms of Portfolio Quality, Efficiency, Stability, Outreach of Operation and Structure of Assets. This study is descriptive utilizing a case study research method while the assessment method was documentary analysis. The statistical technique used was index number in computing financial ratios. The P.E.S.O.S indicators, standards, and the rating system were applied in the determination and interpretation of the overall status of financial performance of the CSU-MPC Microfinancing Services from 2010 to 2014. This study revealed that the overall financial performance of the cooperative is at the scale of 5 (Below 70) from 2010-2014 meaning the cooperative has unsatisfactory performance and is in need of immediate remedial attention. Credit cooperative in this group have a very high probability of failure and will likely require liquidation. To improve the financial performance, the following are the recommendations: A development plan is necessary. Detailed information on the portfolio size, disbursements, repayments, arrears, and aging of receivables is necessary. Provide adequate allowance for probable loan losses. Budgeted ratios should be prepared in order to allow comparison and to incorporate future expectations of cooperative's financial performance.*

Keywords-Catanduanes State University Multi-Purpose Cooperative; financial performance; microfinance services; P.E.S.O. Standard

## INTRODUCTION

Financial performance provides a clear picture of the financial standing of the business ([www.investopedia.com](http://www.investopedia.com)).

Financial standing can be tracked by applying financial ratio analysis; results can influence managerial decision making for improvement of financial structure, and provide lead indications of potential problem areas of a business (Microfinance Council of the Philippines, n.d.).

According to Dr. Lilia Briñes, the General Manager of the cooperative, "the Catanduanes State University Multi-Purpose Cooperative (CSU-MPC) just like any other cooperatives in the Philippines wanted to increase their financial performance to achieve wealth maximization, make prof-

it on a sustainable manner, and maintain the growth and development. And to achieve those goals, one way is by strengthening the microfinancing services' financial performance".

This study is an attempt to assess that financial standing of the Catanduanes State University Multi-Purpose Cooperative's microfinancing services. This study provides benchmarking of the cooperative's financial performances for the last 5 years, and to specifically determine the trends or directions whether they are performing or underperforming on a basis of ratio results from 2010 to 2014.

A careful evaluation of the financial performance of the cooperatives' microfinancing services is really needed to find out the current financial standing.

And to establish a valid review of the financial performance of the CSU-MPC's microfinancing services, PESOS Standard and its formula (MC No. 2003-04 s. 2003) was utilized in ratio analysis. PESOS standard and formula was set by the National Credit Council of the Philippines in cooperation with the Cooperative Development Authority (CDA) of the Philippine since 2003. The CDA has the power and authority to issue and prescribed the use of the PESOS standard. This standard was required in the evaluation of the cooperative in the Philippines to ensure the protection of members, cooperatives, and sustainability.

The Portfolio Quality, Efficiency, Sustainability, Outreach, and Structure of Assets (PESOS) standards and formulas were perfectly fit for this study in the evaluation of the financial performance. Past performances are carefully compared to provide useful or meaningful interpretation of the data to be presented later in the results of the study.

#### **Statement of the Problem**

This study analyzed the financial performance of the Catanduanes State University Multi-Purpose Cooperative Microfinancing Services from 2010-2014.

Specifically, this study was conducted to answer these questions:

1. What is the financial performance of the Catanduanes State University Multi-Purpose Cooperative microfinancing services in terms of:
  - a. Portfolio Quality
  - b. Efficiency
  - c. Stability
  - d. Outreach of operation
  - e. Structure of assets
2. What is the overall financial status of the Catanduanes State University Multi-Purpose Cooperative microfinancing services?
3. What is the trend of financial ratios of Catanduanes Multi-Purpose Cooperative microfinancing services from 2010-2014?

#### **METHODOLOGY**

This study is descriptive utilizing a case study research method.

Case study research is descriptive research that involves describing and interpreting events, conditions, circumstances or situations

that are occurring in the present (Picciano, 2004).

Another case study was used to provide clear picture of the financial performance of the CSU-MPC's microfinancing services. According to Calmorin & Calmorin (2006) case study is a problem-solving technique that describes the past, present, and future. Some writers categorize this method under Descriptive.

The assessment method applied was documentary analysis in which documents are interpreted by the researcher to give voice and meaning around the assessment topic (Administration Method, 2010).

The statistical technique used was index number. According to Lawrence J. Kaplan an index number is a statistical measure of fluctuations in a variable and it represent changes in terms of rates, ratios, or percentages using a base for making comparison (<http://shodhganga.inflibnet.ac.in/bitstream/10603/30246/2/chapter1.pdf>). *The ratios and percentages can be expressed as a proportion, decimal, or fraction (Roque, 1990).*

*In order for this study to evaluate the financial performance of the CSC-MPC's microfinancing services the researcher utilized 2010 as the base year in computing financial ratios.*

#### **FINDINGS**

##### *A. Portfolio Quality*

The portfolio quality of ratios/indicators is the first group to be monitored by the Manager and Board of Directors of the CSC-MPC because this constitutes the bulk of the cooperative's asset. It is important that these assets are adequately protected. Protection is measured by comparing the adequacy of the provisions of loan losses against the amount of delinquent loans. Along with the portfolio quality there are two indicators included in this group the Portfolio at Risk (PAR) and the Allowance for probable loan losses.

For Portfolio at Risk (1) results showed that the ratio of the cooperative in five years in terms of risk of default in the portfolio (see Table 1) has relatively met the standard only in the year 2011 and 2012 since the proportion of PAR is lower than 5% of the total loan outstanding for the said years, however, in the year 2010, 2013, and 2014 the entire loan balances are at risk because

the balance of loans with one day missed payments already exceeded the 5% standard and the risk that the total loans outstanding of the cooperative will be defaulted.

For the allowance for probable loan losses (2) it was not adequately provided by the cooperative as per standard at least 35% of the total loans outstanding balance over 1 to 12 months past due using the PAR to backed up the expected losses of loans in the future, for this, the cooperative got an equivalent point of zero for the entire five years. From year 2010 until 2014 the cooperative has not adequately provided the necessary amount of allowance for losses, this kind of status of the portfolio will make the cooperative imperil the financial sustainability of the cooperative in the next few years.

Table 1. Portfolio at Risk (1) and Allowance for Probable Loan Losses (2)

### B. Efficiency

The second group of indicators focuses on the operations and administrative efficiency of the delivery of the financial services. Indicators under this category determine the ability of the cooperative to generate sufficient income to cover expenses on operations. Six ratios are included in this group. These are Asset Yield, Operational Self-Sufficiency, Rate of Return on Member's share, Loan Portfolio Profitability, Cost per Peso Loan, and Administrative Efficiency.

Year	R a t i o		S t a n d a r d		S c o r e		E q u i v a l e n t	
	(1)	(2)	(1)	(2)	(1)	(2)	(1)	(2)
2010	15%	0.004	≤5%	35%	>5%	<1%	6	0
2011	5%	0.002	≤5%	35%	<5%	<1%	15	0
2012	4%	0.001	≤5%	35%	<5%	<1%	15	0
2013	6%	0.001	≤5%	35%	>10%	<1%	12	0
2014	6%	0.004	≤5%	35%	>10%	<1%	12	0

For the Asset Yield ratio (1) as shown in Table 2 the cooperative has very low ratios in five years time (2010-2014). The proportion of undivided net surplus to average total assets was below the ratio of inflation rate, the standard is to surpass or at least achieved the rate of inflation therefore, since the cooperative has not achieved the needed ratio it only manifests that the income generation from the assets was very low due to non- utilizing of the assets for investment.

Table 2. Asset Yield (1)

For operational self-sufficiency (2) the ratio of the cooperative as shown in Table 3 was below the standard, this means that the cooperative financing income did not reach the needed ratio, the interest income from loans, service fees, filing fees, fines, penalties, and surcharges should be greater than 100% of the financing cost or administrative costs. The standard requires 20% higher than the financing/administrative cost in order to absorb the relevant expenses and sustain the operation of the microfinancing services. The cooperative failed to achieve the needed ratio for the Year 2010 until 2014. The ratio was only 73% for 2010, 108% for 2011, 107% for 2012, 101% for 2013, and 91% for 2014 lower than the standard of 120% as required.

Year	Ratio	Inflation Rate	Standard	Score	Equivalent
2010	0.03	3.8	Higher than inflation Rate	>2% below	1
2011	0.07	4.7		>2% below	1
2012	0.07	3.2		>2% below	1
2013	0.10	3.0		>2% below	1
2014	0.08	4.1		>2% below	1

For this, operational self-sufficiency cannot be achieved.

Table 3. Operational Self-Sufficiency (2)

For the rate of return on member's share (3) ratio only 2% for 2010, 5% for 2011 and 2012, 7% for 2013, and 6% for 2014 which are below the inflation rate was shown in Table 4. The standard requires the cooperative to achieve ratio which is equivalent or higher than the inflation rate. For this, it manifests that the earning power of member's share capital was very low. This is also supported by the Asset Yield ratio, since the cooperative are not investing their money in some other services or ventures this likewise has an impact on the poor earning power of the members of the cooperative.

Table 4. Rate of Return on Member's Share (3)

So far, the loan portfolio profitability (4) ratio of the cooperative is earning as shown in Table 5 it surpassed the standard ratio of 20% for 5

years. For 2010 the ratio is 21%, 34% for 2011,

Year	Ratio	Standard	Score	Equivalent
2010	0.73	>120%	<100%	0
2011	1.08		100%- <110%	2
2012	1.07		100%- <110%	2
2013	1.01		100%- <110%	2
2014	0.91		<100%	0

33% for 2012 and 2013, and 25% for 2014. Therefore, the loan portfolio of the cooperative is profitable.

Table 5. Loan Portfolio Profitability (4)

For cost per peso loan (5) the standard requires the cooperative to maintain the cost from 10 centavo for every Php 1.00 average total loan outstanding, ratios showed that the cooperative is spending more relative to the costs of financing, administrative and member's benefits in 2010 for 25 centavos, 28 centavos for 2011, 49 centavos for 2012, 43 centavos for 2013, and 22 centavos for 2014 for every Php 1.00 of average total loans outstanding. The ratio exceeded the required cost and

Year	Ratio	Inflation Rate	Standard	Score	Equivalent
2010	0.02	3.8	At least inflation Rate	>4%	1
2011	0.05	4.7		>4%	1
2012	0.05	3.2		>4%	1
2013	0.07	3.0		>4%	1
2014	0.06	4.1		>4%	1

therefore not within the standard. Therefore, this manifests that the cooperative is inefficiently managed the coop's loan portfolio.

Table 6. Cost Per Peso Loan (5)

For Administrative Efficiency (6) Table 7 shows the costs of managing the cooperative's assets. Based from the standard the administrative cost must fall within 3% to 10% of average Total

Year	Ratio	Standard	Score	Equivalent
2010	0.21	More than 20%	Above 20%	4
2011	0.34		Above 20%	4
2012	0.33		Above 20%	4
2013	0.33		Above 20%	4
2014	0.25		Above 20%	4

Assets. From 2010-2011 the costs are 12% and 13% of the average Total Assets and are exceeded the expected 10% requirement but from 2012 to 2014 the costs are 8% for 2012 and 2013, and 7% for 2014, for this, the cooperative able to maintained the required ratio for the administrative costs for the lasts three years.

Table 7. Administrative Efficiency (6)

### C. Stability

The stability of the cooperative is im-

Year	Ratio	Standard	Score	Equivalent
2010	0.25	PhP 0.10 per PhP 1.00 loan	Above 0.20	0
2011	0.28		Above 0.20	0
2012	0.49		Above 0.20	0
2013	0.43		Above 0.20	0
2014	0.22		Above 0.20	0

portant to ensure that the microfinancing services are delivered to its members in a sustained manner. There are three indicators under this category; these are Solvency, Liquidity, and Net Institutional Capital.

Table 8 shows the solvency (1) ratio in five years. In this ratio the net assets should be 10% higher than the combined total deposits and share capital. From 2010 to 2011 the net assets of the cooperative achieved only 47% and 42% of the combined total deposits and share capital, during those years the cooperative has a low degree of protection against losses, the risks are greater for the members/savers against losses, but in 2012

Year	Ratio	Standard	Score	Equivalent
2010	0.12	3% to 10%	>10%	1.5
2011	0.13		>10%	1.5
2012	0.08		<10%	2
2013	0.08		<10%	2
2014	0.07		<10%	2

the ratio is 120%, 107% for 2013, and 105% for 2014, therefore starting 2012 to 2014 the cooperative had considerably increased the degree of protection to the members against losses but still not



within the standard except in 2012.

Table 8. Solvency (1)

For liquidity ratio (2) it measures the proportion of net of liquid assets from short term payables to total deposits and the standard requires the cooperative to maintain 15% or more of the ratio. However, the cooperative surpasses the standard ratio which is over and above 15%, for 2010 the ratio is 334%, 296% for 2011, 349% for 2012, 336% for 2013, and 337% 2014. Therefore, the cooperative has the ability to service its member's deposits on time. This also manifests that the cooperative has greater cash that can be put to better use in the business but instead it is deposited in other banks or placed in vault.

Table 9. Liquidity (2)

The net institutional capital (3) is the net of reserve and allowance for probable losses from past due loans and problem assets. This ratio should be maintained at 10% of the total assets as per standard. Table 10 shows the level of the net institutional capital wherein the cooperative has maintained a very low ratio due to allowances for

Year	Ratio	Standard	Score	Equivalent
2010	0.47	At least 110%	<70%	0
2011	0.42		<70%	0
2012	1.23		>100%	10
2013	1.07		>110%	8
2014	1.05		>110%	8

probable loan losses (*please see Table 1*) was not adequately provided by the cooperative which basically resulted to a very low net institutional capital. The ratios for 2010 is only 2%, 4% for 2011, 2012 and 2014, and 5% for 2013.

Table 10. Net Institutional Capital (3)

#### D. Outreach of Operation

Under this group two indicators are included; these are the (1) growth in membership and the (2) trend in external borrowings.

For the growth in membership (1) this ratio will determine the changes in membership vis-à-vis target. The target can be based on the development plan of the cooperative since it is

Year	Ratio	Standard	Score	Equivalent
2010	3.34	Not less than 15%	>15%	10
2011	2.96		>15%	10
2012	3.49		>15%	10
2013	3.36		>15%	10
2014	3.37		>15%	10

incorporated in it. The standard required that if the target was achieved more than 75% it will earned a highest point score of 5 and based from the results in Table 11, the target increase in membership was achieved in the year 2011, 2012, and 2014 except in the year 2010 and 2013.

Table 11. Growth in Membership (1)

For the trend in external borrowings, the ratio determines the percentage of change in external borrowings. This indicator calls for a strong emphasis on mobilizing voluntary savings from its members. The standard for the trend in external borrowings should be decreasing towards zero. Table 12 shows that the cooperative is still

Year	Ratio	Standard	Score	Equivalent
2010	0.02	At least 10%	>3%	2
2011	0.04		>3%	4
2012	0.04		>3%	4
2013	0.05		>3%	4
2014	0.04		>3%	4

relying on the outside financing though there is an impressive moved in between year 2011 to 2012 that the trend decreased tremendously from 104% to 5%. The highest external borrowings was recorded at 104% in 2011, followed by 93% in 2010, then 71% in 2014, then it remarkably reaches 5% in 2012 and 2013. However, the ratios showed that savings mobilization is hardly achieved hence, external borrowings are unavoidable.

Table 12. Trend in External Borrowings (2)

#### E. Structure of Assets

The structure of assets has four indicators that will help the cooperative ascertain the quality and the structure of their assets. These indicators are composed of (1) asset quality by determining the percentage of non-earning assets from the total assets, and the other one is the (2) asset struc-

Year	Ratio	Standard	Score	Equivalent
2010	0.67	Target set in the development plan	<75%	4
2011	0.93		>75%	5
2012	0.80		>75%	5
2013	0.73		<75%	4
2014	0.80		>75%	5

ture. Asset Structure is composed of three ratios, these are the percentage of total assets financed by deposits, percentage of assets invested in loan portfolio, and the last one is the percentage of total assets financed by member's share capital.

For the asset quality of the cooperative,

the percentage of total assets that are not producing income should not be more than 5% as per standard. The more the non-earning assets the more it manifests that the cooperative is not really utilizing the assets for investment. Table 13 shows that in five years time the cooperative has maintained high percentage of assets that are not producing income to the cooperative, this results was also supported by the ratios given in Table 2 for Asset Yield, Table 4 for Rate of Return on member's Share and Table 9 for Liquidity. Therefore, non-performing assets of the cooperative exceeded what is required, since in 2010 the non-earning

Year	Ratio	Standard	Score	Equivalent
2010	0.93	Decreasing towards zero	Decreasing	3
2011	1.04		Increasing	0
2012	0.05		Decreasing	3
2013	0.05		Status Quo	2
2014	0.71		Increasing	0

assets are 14%, 10% for 2011, 9% for 2012, and 7% for 2013 and 2014.

Table 13. Asset Quality (1)

For the asset structure, the percentage of total assets financed by deposits should fall in between 55% to 65%. Table 14 shows the percentages of total assets financed by deposits in 2010 was only 41%, 39% for 2011, 38% for 2012, 43% for 2013, and 45% for 2014. This means money coming from deposits was not fully utilized in the operation. At least if the cooperative fully maximize the usage of the percentage of the deposits they can decrease the reliance of the cooperative from external borrowings (*please see Table 12*).

Table 14. Asset Structure (Total Deposits/Total Assets)

The net loans receivable measures the percentage of total assets invested in the loan portfolio. The standard was set at 70% to 80%. Table 15 shows the percentage of total assets invested in the loan portfolio in 2010 is only 54%, 51% in 2011, 59% in 2012, 64% in 2013, and 66% in 2014. The cooperative put lesser investments of net loans receivable in the portfolio, and again, this evidenced that the cooperative are not utilizing their money to the fullest. The effect is on the rate of returns of the member's share.

Table 15. Asset Structure (Net Loans Receivable/Total Assets)

Table 16 shows the total member's share capital in proportion to total assets, the percentage

of total assets financed by member's share capital

Year	Ratio	Standard	Score	Equivalent
2010	0.14	Not more than 5%	>12%	1
2011	0.10		>8-10%	3
2012	0.09		>8-10%	3
2013	0.07		>6-8%	4
2014	0.07		>6-8%	4

should be set at 35% to 45%. The ratio for 2010 was 36% while 28% for 2011, 19% for 2012, 18% for 2013, and 20% for 2014. Again this indicator showed that the cooperative was not fully utilizing the money of the member's or borrowers, this also makes the cooperative very liquid since a lot of money was put in the safety deposit to other banks.

Table 16. Asset Structure (Total Member's Share Capital/Total Assets)

#### F. Overall Financial Status

After all the Equivalent score was added (*see Table 18*) the resulting rating for each of the component has given appropriate weight to arrive

Year	Ratio	Standard	Score	Equivalent
2010	0.41	55% to 65%	35%-44%	1
2011	0.39		35%-44%	1
2012	0.38		35%-44%	1
2013	0.43		35%-44%	1
2014	0.45		45%-55%	3

at overall rating. The Portfolio Quality (25%), Efficiency (20%), Stability (30%), Operations (10%), and Structure of Assets (15%), these comprised the P.E.S.O.S total (100%). The summary showed in Table 18, for the Year 2010 P.E.S.O.S overall rating is 38.5, 49.5 in 2011, 62 in 2012, 56.5 in 2013, and 53.5 in 2014. The PESOS standard has the following rating scale to be used:

- Rating 1 (96-100) Very Good
- Rating 2 (90-95) Good
- Rating 3 (80-89) Fair
- Rating 4 (70-79) Poor
- Rating 5 (Below 70) Very Poor

Year	Ratio	Standard	Score	Equivalent
2010	0.54	70% to 80%	50%-60%	1
2011	0.51		50%-60%	1
2012	0.59		50%-60%	1
2013	0.64		60% - 70%	1.5
2014	0.66		60% - 70%	1.5

Therefore, the overall financial status of

CSU-MPC Microfinancing Services from 2010 to 2014 was VERY POOR; the summary was shown in Table 17. For the interpretation of the results PESOS overall rating system was used. The scale Below 70 was rated as 5, meaning the CSU-MPC has unsatisfactory performance and is in need of immediate remedial attention. Credit cooperatives in this group have a very high probability of failure and will likely require liquidation.

Therefore, the financial performance of CSU-MPC's microfinancing services if left unchecked would lead to conditions that would

Year	Ratio	Standard	Score	Equivalent
2010	0.36	35% to 45%	35%-45%	3
2011	0.28		25%-30%	1
2012	0.19		Below 25%	0
2013	0.18		Below 25%	0
2014	0.20		Below 25%	0

threaten its viability. A high potential for failure is present but is not yet imminent.

Table 17. Overall Financial Status

#### G. Trends of Financial Ratios from 2008-2012

Table 18 shows that the trends of financial ratios from 2010-2014 is neither increasing nor decreasing, the ratios fluctuates from period to period. The total equivalent points are below 70 (Scale 5) from 2010-2014. This indicates very poor performance on a year to year basis. The performances of the cooperative remain at constant for the past five years.

Table 18. The Trends of Financial Ratios From 2010-2014

## CONCLUSIONS

Based on the findings of the study, the following conclusions were drawn:

1. Portfolio at risk ratio for 2011-2012 did not meet the standard while in 2010, 2013, and 2014 the ratios are within the standard.
2. Allowance for probable loan losses was not adequately provided, the equivalent points is zero from 2010-2014.
3. The asset yield was lower than the inflation rate. Manifested poor performance in generating income from the assets.
4. The operational self-sufficiency ratio was below the standard of 120%.
5. The rate of return on member's share ratio

was below the inflation rate.

6. The loan portfolios of the cooperative is profitable from 2010-2014.

7. The cost per peso loan exceeded PhP 0.10 which manifests inefficiency as to managing the coop loan portfolios.

Year	Total Point Score	Adjectival Rating
2010	Below 70	Very Poor
2011	Below 70	Very Poor
2012	Below 70	Very Poor
2013	Below 70	Very Poor
2014	Below 70	Very Poor

8. The administrative efficiency ratios met the standard from 2012-2014 however, for 2010-2011 the ratio falls beyond the standard.

9. Solvency ratios for 2010-2011 are not within the standard but in 2012-2014 the ratio increases.

10. Liquidity ratios surpasses the standard from 2010-2014.

11. The net institutional capital ratio is not within the standard.

12. The target in membership was almost achieved.

13. The trend in external borrowings is fluctuating.

Indicators	2010	2011	2012	2013	2014	Trend
Portfolio Quality (25%)	6	15	15	12	12	Fluctuating
Efficiency (20%)	7.5	9.5	10	10	8	Fluctuating
Stability (30%)	12	14	24	22	22	Fluctuating
Outreach of Operation (10%)	7	5	8	6	5	Fluctuating
Structure of Assets (15%)	6	6	5	6.5	6.5	Fluctuating
Total (100%)	38.5	49.5	62	56.5	53.5	Fluctuating
Scale	5	5	5	5	5	

tuating.

14. The percentage of total assets that are not producing income is more than 5%.

15. Total assets that are financed by deposits is below 55%. The percentage of total assets invested in the loan portfolio is below 70%. The percentage of total assets financed by member's share capital is below 35% except in 2010.

16. The overall financial status of the cooperative from 2010 to 2014 is very poor.
17. The trends of the financial ratios fluctuate from period to period.

## RECOMMENDATIONS

Based on the findings and conclusions the following are the recommendations:

1. **Portfolio at Risk.** The level of risk in the portfolio requires regular or close monitoring and analysis.
2. **Allowance for Probable Loan Losses.** It must be adequately provided once loan is considered at risk; the risk of some loans may not be paid back and it must be anticipated. The cooperative must establish a provision of detailed information on the portfolio size, disbursements, repayments, arrears, aging of loans receivable, principal write-offs and other elements that are necessary to ascertain the level of risk and track portfolio quality.
3. **Asset Yield.** The cooperative may engage into another viable business venture aside from microfinancing to maximize the utilization of the assets and generate profits. Future expansion of the services to be provided by the cooperative to its members must be considered.
4. **Operational Self-Sufficiency.** The cooperative must monitor the accuracy of the computation of fines, penalties, surcharges aside from the interest income from loans and service fees to assure that the financial income can fully absorb the financing cost or administrative costs of the cooperative so that operational self-sufficiency will be achieved.
5. **Rate of Return on Member's Share.** There is no other way around to increase the earning power of the members but to invest the non-performing assets of the cooperative into another viable business venture.
6. **Loan Portfolio Profitability.** Maintain the profitability of the loan portfolios by strengthening the collection efficiency so that cash inflows can substantially finance more loans of the cooperative's members/clients loan applications.
7. **Cost per Peso Loan.** As much as possible lower the reliance on the external borrowings due to financing costs are higher instead savings mobilization is recommended. To observe efficiency in the management of loan portfolios the cooperative must maintain at least 10 centavo cost for every PhP 1.00 of total loans outstanding to achieve a maximum profit on the portfolios.
8. **Administrative Efficiency.** As manifested by the ratio administrative cost was higher, for this, the cooperative may review periodically the number of employees needed since most of the administrative costs of the cooperative are for their salaries and wages, another, most of the employees are regular, administrative costs can be lowered if hiring employees on contract basis will be considered in the future.
9. **Solvency.** To improve the degree of protection against losses of the cooperative the net assets should be maintained at least 110% of the combined deposits and share capital.
10. **Liquidity.** The liquidity status of the cooperative was very high but it has negative impact since it only manifests that more money are dormant and is not generating income to the cooperative. Again, the cooperative should not maintain it on a high proportion instead these assets can be utilized or be invested in other business activities to produce more income.
11. **Net Institutional Capital.** One way of achieving stability is to increase the net institutional capital instead on relying on the share capital of the member. One way of achieving it is to provide adequate allowance for probable loan losses aside from the reserves so that in moment that there are past due loans and problem assets still the cooperative can absorb those amounts to ascertain the sustainability of the operation.
12. **Growth in Membership.** A development plan is necessary; it must include a target increase in numbers of members.
13. **Trend in External Borrowings.** As much as possible decrease dependence on external borrowings and put strong emphasis on the savings mobilization on voluntary savings from its members. In the end, less dependence on borrowings would only mean lower financial costs.
14. **Asset Quality.** Non-earning assets should always be maintained at 5% or lower of the total assets for profit maximization.
15. **Asset Structure.** Assets can be financed by deposits, nets loans receivable or the member's share capital. Cooperative must maintained the required ratio so that external borrowings can be avoided and become fully equity funded.
16. To achieve a rating of 1 VERY GOOD, those areas revealed by this study that needs greater concerns must be given preferential attention especially to the ratios that are not within the standard. Cooperative must perform safe and sound operations.
17. The budgeted ratios should be prepared in order to allow comparison and to incorporate future expectations on the cooperative's financial perfor-

mance.

## ACKNOWLEDGEMENT

Special gratitude to the management and staff of Catanduanes State University Multi-Purpose Cooperative for helping and granting permission to look at the confidential documents which contributed to the completion of this RESEARCH WORK!

*M.I.L.DH*

## REFERENCES

- Administration Method* (2010). Retrieved March 2, 2012, from Student Voice Web site: <https://www.studentvoice.com/app/wiki/>
- Calmorin, Laurentina and Calmorin, Melchor (2006). *Methods of Research and Thesis Writing*. Rex Bookstore Philippines.
- Catanduanes State University Multi-Purpose Cooperative *Annual Reports* from 2010-2014.
- Chapter 1*. Shodhganga. Retrieved on October 5, 2015 at <http://shodhganga.inflibnet.ac.in/bitstream/10603/30246/2/chapter1.pdf>
- Cooperative Development Authority of the Philippines. *Memorandum Circular 2003-04 s. 2003*. The Performance Standards for Credit and Other Types of Cooperatives with Credit Services (COOP-PESOS).
- Microfinance Council of the Philippines, Inc (n.d). *Key Financial Ratios-MCPI Updates*. Philippines
- Picciano, A. G. (2004). *Educational Research Primer*. London: Continuum.
- Roque, Rodelio S. (1990). *Management Advisory*. Roque Press Inc. Philippines
- [www.investopedia.com](http://www.investopedia.com)

# OPTIMAL LOW POWER CMOS OPAMP DESIGN FOR AN ALTERNATIVE POWER SOURCE

**Engr. Gillert M. Bongcac, MoE**

Mindanao State University – Iligan Institute of Technology  
Iligan City, Philippines  
phyton\_gil@yahoo.com

## ABSTRACT

*This study presents a CMOS operational amplifier for the alternative power source project in the two stage topology. It is low power and operates at 1.8 V power supply. For this study, experimental design is applied with the use of HSpice simulation. A comparative analysis is done on the results to determine what size produces the optimum performance. The design exhibits minimum power dissipation in the microwatt level and a slew rate within limit. The open-loop gain is at maximum value and with a phase margin within range. The simulation results obtained proves that the design is capable of amplifying small voltage source.*

**Keywords:** Operational Amplifier for Alternative Power Source, CMOS OpAmp, Optimal OpAmp, Low Power OpAmp

## INTRODUCTION

Over the last few years, the electronics industry has exploded. The largest segment of total worldwide sales is dominated by metal-oxide semiconductor (MOS) market. Complimentary metal-oxide semiconductor (CMOS) technology continues to mature with minimum feature sizes now. Designing high performance analog integrated circuits is becoming increasingly demanding with the relentless trend toward reduced supply voltages and transistor channel length. A large part of the success of the MOS transistor is due to the fact that it can be scaled to increasingly smaller dimensions, which results in higher performance [Saurabh & Raja, 2013]. As the scale of integration improves, more transistors, faster and smaller than their predecessors, are being packed into a chip [Modi & Patel, 2013].

Operational Amplifier (OpAmp) is the most common building blocks of most of the electronics system. An operational amplifier, is a very high gain differential amplifier with high input impedance and low output impedance. The basic circuit is made using a difference amplifier having two inputs (plus and minus) and at least one output. The design of OpAmps continues to pose a challenge as the supply voltage and transistor channel lengths scale down with each generation of CMOS technologies.

The input of the OpAmp will come from the thermoelectric generator (TEG) and will be amplified using the two-stage architecture. The variability of the input signal means unstable output voltage. Also, the supply voltage of the operational amplifier must be small in order not to deplete the source. To address this gap, this study will design a low power operational amplifier that will give sufficient output voltage to the voltage charger circuit of the alternative power source project.

## Theoretical/Conceptual Framework

The general block diagram of an op-amp is shown in Fig. 1. The first block is a differential amplifier. It has two inputs which are the inverting and non-inverting voltage. It provides at the output a differential voltage or a differential current that, essentially, depends on the differential input only. It is also a differential to single-ended converter. It is used to transform the differential signal generated by the first block into a single ended version. In most cases the gain provided by the input stages is not sufficient and additional amplification is required. This is provided by the second stage, which is another differential amplifier, driven by the output of the first stage. As this stage uses differential input unbalanced output differential amplifier, so it provide required extra gain.



### Fig. 3. Gain Bandwidth

The gain of the stage is simply the transconductance of  $M_2$  times the total output resistance seen at the drain of  $M_2$ . The two main resistances that contribute to the output resistance are that of the input transistors themselves and also the output resistance of the active load transistors,  $M_3$  and  $M_4$ . The current mirror active load used in this circuit has three distinct advantages. First, the use of active load devices creates a large output resistance in a relatively small amount of die area. The current mirror topology performs the differential to single-ended conversion of the input signal, and finally, the load also helps with common mode rejection ratio. In this stage, the conversion from differential to single ended is achieved by using a current mirror ( $M_3$  and  $M_4$ ). The differential current from  $M_1$  and  $M_2$  multiplied by the output resistance of the first stage gives the single-ended output voltage, which constitutes the input of the second gain stage.

The purpose of the second gain stage, as the name implies, is to provide additional gain in the amplifier. Consisting of transistors  $M_6$  and  $M_7$ , this stage takes the output from the drain of  $M_2$  and amplifies it through  $M_6$  which is in the standard common source configuration. Again, similar to the differential gain stage, this stage employs an active device,  $M_7$ , to serve as the load resistance for  $M_6$ . The gain of this stage is the transconductance of  $M_6$  times the effective load resistance comprised of the output resistances of  $M_6$  and  $M_7$ .

## RESEARCH DESIGN AND METHODOLOGY

### Research Design

For this study, experimental design is applied with the help of Hspice simulation. Specifications are set to be the typical values for the architecture chosen and to optimize the operation of the OpAmp. The basic structure of the design is an architecture already available. This results in a schematic showing the transistors and their interconnections. This diagram does not change throughout the remainder of the design unless the specifications cannot be met, then a new or modified structure must be developed. The selection of the dc currents and transistor sizes can now be

determined. Most of the effort of design is in this category. This begins with hand calculations based upon approximate design equations. After each device is sized by hand, a circuit simulator is used to fine tune the design. This step is iterated when necessary to suit the needed requirement of the design. Two variations of the design is set-up:

1. Transistor sizes with multipliers; and
2. Transistor with exact sizes

A comparative analysis is done to identify what size is optimal for use. Comparing the coefficient of variation from the post test results will identify which has a more consistent performance. A more consistent performance means a lesser coefficient of variation.

### Design Method

The two-stage operational amplifier is a widely used analog building block. Thus, this study adapts this architecture to be used. From the specifications, the calculation can be established. The individual transistor from the whole schematic is analyzed and simulated separately to determine the right ratio of W/L.

### Determination of Transistor Sizes

The transconductance of the first stage is equal to the transconductance of  $M_1$ . Since  $M_2$  is mirrored with  $M_1$ , their transconductance and device ratio is equal. With the target value in hand, Hspice simulation is used to determine the right device ratio without compromising the region of operation of the transistor, that is saturation. From the target value of the output conductance of  $M_3$ , the device ratio can be determined using simulation. Since  $M_4$  is mirrored with  $M_3$ , they have the same ratio. This ends the first stage of the architecture.

The transconductance of the second stage is equal to the transconductance of  $M_6$ . With this, the ratio of  $M_6$  can be determined. The drain current in  $M_6$  is equal to  $M_7$ . With this target value, the ratio of  $M_7$  is determined. The drain current of  $M_5$  is equal to twice the drain current of  $M_1$ . With this target value, the ratio of  $M_5$  is determined. For the last transistor  $M_0$ , a target value for the gate voltage is set. With this, the device ratio is established.



## Simulation of the design

Simulation using Hspice requires node names and so each node is labeled carefully. The eight transistors are coded with node names and their equivalent W/L. The region of operation of the transistor is then viewed to see if it is in saturation. When all eight of the transistor is in saturation, the following data can now be collected as pre-test results: open loop gain, gain bandwidth, phase margin, slew rate, common mode rejection ratio, and power dissipation. The parameters mentioned are the results obtained before negative feedback is applied to the design. The pre-test result will show the stability of the design. The post-test results shows the output of the opamp in relation to the input while negative feedback is employed. The post-test result determines whether the design is capable of amplifying small input voltage.

## Stability of the Design

For the stability of the design, the loop gain must be less than unity when the phase reaches beyond-  $180^\circ$  shift relative to phase. In the time domain, stable design will result to a response where the output settles to a finite settling time. Unstable response can have constant amplitude or growing amplitude. Both will result to oscillation at the output.

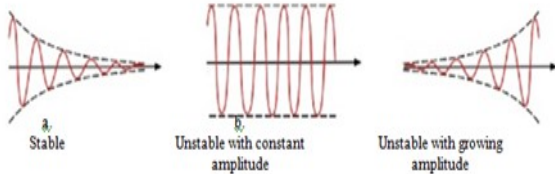
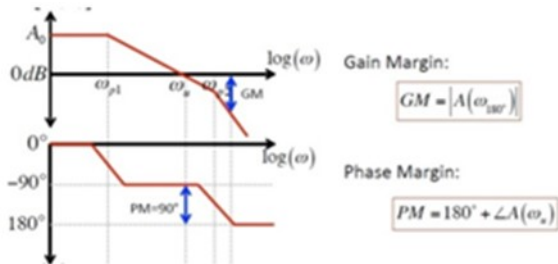

Figure 4. Stability in time domain

Another measure of stability is given by the phase margin and is measured as the phase shift when frequency loop gain is 1.



The phase margin should be at least  $45^\circ$  and preferably  $60^\circ$  or larger. Another measure of stability is given by the gain margin where it is the difference between the unity gain and actual loop gain at frequency where phase shift is  $-180^\circ$ . It should be greater than 0 dB.

## OpAmp Specification

Specifications are set to be the typical values for the architecture chosen and to optimize the operation of the OpAmp. The slew rate is calculated to be the current from  $M_5$  divided by the compensating capacitor ( $C_c$ ).  $C_L$  is set to be 1 pF while  $C_c$  is one-third of  $C_L$ . The open-loop gain ( $A_0$ ) and gain bandwidth (GBW) is set to be 80 dB and 10 MHz respectively. For stability purposes, the phase margin is assumed to be  $60^\circ$ .

Table 3.1 Shows the specification for the design of operational amplifier.

OpAmp Specification	Value
$V_{DD}$	1.8 V
Slew Rate (SR)	14 V/ $\mu$ s
$C_L$	1 pF
$C_C$	0.33 pF
Open-Loop Gain ( $A_0$ )	80 dB
Gain Bandwidth (GBW)	10 MHz
Phase Margin (PM)	$60^\circ$
Power Dissipation	optimum



### Pretest Results with exact sizes

In the simulation, the two stage operational amplifier has a slew rate of 10.2 V/uS. It relates how closely the output responds to a change in input voltage. A pulse voltage is applied to the input and then the slope of the output is measured. The red line is the input voltage while the green line is the output.

The settling time in the graph is shown to be 0.58μsec. It is the same graph as in the slew rate but the only difference is that the settling time measures how long it will take for the output to stabilize. In the graph it seen that it has a finite settling time, thus making the design stable.

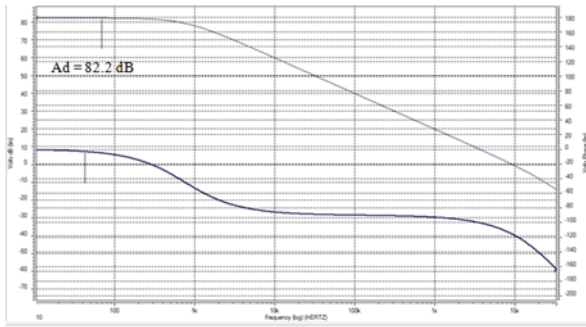

**Figure 7. Common Mode Rejection**

From the simulation, the CMRR is 74.19 db. Common Mode Rejection Ratio (CMRR) is the ability of rejecting common mode signal

$$\begin{aligned} \text{CMRR} &= A_d - A_{cm} \\ &= 82.2 \text{ dB} - 8.01 \text{ dB} \\ &= 74.19 \text{ dB} \end{aligned}$$

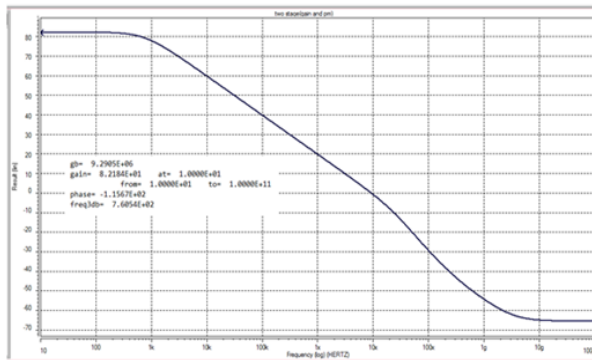

Table 3.2 Lists the design objective vs. the simulated results.

**Figure 8. Frequency at 3dB**

From the simulation result, the two stage opamp has a frequency at 3dB of 760.59 Hz.

Specification	Design Objective	Simulated Result with Exact	Simulated Result with multipliers
Slew Rate (SR)	14 V/μs	10.2 V/μsec	14.5 V/μsec
Open-Loop Gain (A <sub>0</sub> )	80 dB	82.184 dB	80.193 dB
Gain Bandwidth (GBW)	10 MHz	9.29 MHz	10.8 MHz
Phase Margin (PM)	60°	64.33°	67.63°
Common Mode Rejection Ratio (CMRR)	-	74.19 dB	71.94 dB
Frequency at 3dB (f <sub>3dB</sub> )	-	760.54 Hz	1.1 kHz
Power Dissipation	optimum	38.6538 μW	53.1964 μW
Settling Time (t <sub>s</sub> )	-	0.58μsec	0.96μsec

The table above shows how the parameters change with a change in transistor sizes. Although both design closely agree to the specifications, one has performs better than the other in terms of each specification.

### Post Test Results of design with multipliers and exact sizes

0.002	1.7718
0.003	1.7828
0.004	1.7858
0.005	1.7865

$$\text{Mean} = \frac{1.7290 + 1.7718 + 1.7828 + 1.7858 + 1.7865}{5} = 1.7712 \text{ V}$$

$$\text{Standard Deviation} = \sqrt{\frac{\sum X^2 - \frac{(\sum X)^2}{n}}{n-1}} = 0$$

.0243

$$\begin{aligned} \text{Coefficient of variation} &= \\ &= \frac{\text{Standard Deviation}}{\text{Mean}} = \frac{0.0243}{1.7712} = 0.0137 \end{aligned}$$

The coefficient of variation reveals that the design with multiplier is more variable than the design with exact sizes. This shows that the design with exact sizes is more consistent than that of the design with multipliers.

### Discussion of Results

The pretest results obtained shows the performance of the design. From the simulation output, it was confirmed that the transistors were in saturation. The results of the design with multipliers and those with exact values closely agree to the specification. Although the specifications are met, there are difference between the two: the open-loop gain of the design with exact transistor sizes is much larger than the design that employs multipliers; the

slew rate of the design with exact sizes is less than that of the other; the gain bandwidth of the design with exact sizes is less than the design with multipliers; a lesser phase margin is seen in the design with exact sizes; a larger CMRR is seen in transistors with exact sizes; a larger settling time is observed in the design with multipliers; and a lesser power dissipation in the design with exact transistor sizes.

In the post test result, a negative feedback is employed. Negative feedback is used to create a condition of equilibrium. A feedback resistor of 10 MΩ and R<sub>1</sub> of 1MΩ is connected. With a corresponding input voltage, an output voltage is obtained. The coefficient of variation shows which of the two design is more consistent-lesser value means more consistent performance. The area of the design with multipliers is approximately 64 sq. μm while the design with exact sizes is approximately 48 sq. μm. In this case the design with exact sizes uses less space than that of the design with multipliers.

### Interpretation of Results

The transistors in the design operates at saturation since the drain current is at maximum

$$I_d = \frac{K_n}{2} (V_{GS} - V_{TN})^2$$

value, . The resulting power of the design with exact value is much smaller compared to that of the design with multiplier. The open-loop gain of the design is the product of the first stage and the second stage. In this parameter, the design with exact value has the upper hand. The phase margin of the design indicates stability of the opamp. The typical target for phase margin is between 45° to 60°. Although both show a phase margin greater than is required, the design with multipliers has the advantage. Thus the design with multipliers showing a phase margin of 67.63 is more stable. The settling time of the design with exact sizes is less than the design with multipliers. This indicates that the output settles at a faster time of 0.58μsec in the design with exact sizes. With the graph, it is shown that the output is stable since the output does not show a constant or growing amplitude. Un-

Unstable output will result to oscillation. The CMRR result shows that it has a capacity to reject common mode signals. The slew rate of the design with exact sizes is more advantageous than the other design. In the post-test results, the output shows that both design is capable of amplifying small signal input voltage. However, their value of consistency differs. The design with exact sizes exhibits a smaller coefficient of variation thus the performance is more consistent.

When specification such as power dissipation, slew rate, open-loop gain, CMRR, and settling time is given more importance, it is better to use the design with exact sizes. When gain bandwidth and phase margin is given more importance the design with multipliers is better. Although the design with exact value has a smaller area compared to the design with multipliers, it is harder to lay-out and maybe more prone to errors in manufacturing.

## CONCLUSION

With the overall performance of the design, the following conclusions are derived:

1. The simulated output shows and confirms the functionality of the design presented in this study; and
2. The design with exact sizes is more dependable in terms of slew rate, open-loop gain, CMRR, power dissipation, and settling time.
3. The area of the design with exact transistor sizes is smaller compared to the design with multipliers.
4. Different values of W/L will affect numerous simulated specification.

## REFERENCES

- Allen, P. & Hollberg, D. (2013). CMOS Analog Circuit Design. Oxford, England: Oxford University.
- Baruah, R.K. (2010). Design of a Low Power Low Voltage OpAmp. *International Journal of VLSI Design & Communications Systems*, 1(1), 1-8. Doi:10.5121/vlsic.2010.1101.
- Bhardwaj V.K., Kumar H., Kumar P., Ahmed A. (2012). A Low Power 2 GHz Unity Gain Frequency with 154 PSRR CMOS OTA. *International Conference on Solid-State and Integrated Circuit*, 3, 28-33.
- Boylestad, R. & Nashelsky, L. (2012). *Electronic Devices and Circuit Theory*, 11<sup>th</sup> edition. Columbus, Ohio: Prentice Hall.
- Jaeger, R. & Blalock, T. (2011). *Microelectronics Circuit Design*, 4<sup>th</sup> edition. New York, NY: The McGraw-Hill Companies, Inc.
- Liu, G. (2006). *Fully Integrated CMOS Power Amplifier*. Berkeley, CA: University of California.
- Maghami M.H., Inanlou F., Lotfi R. (2008). Simulation-Equation-Based Methodology for Design of CMOS Amplifiers Using Geometric Programming. *IEEE*, 360-363.
- Mal, A.K., Mondal, A., Hari, O.P., & Todani, R (2012). Simulator Based Simplified Design Approach of a CMOS 2-Stage OpAmp. *International Journal of Engineering and Technology*, 4(6), 826-830. Doi:10.7763/IJET.2012.V4.493.
- Maloberti, F. (2006). *Analog Design for CMOS VLSI Systems*. Springer.
- Modi, H. & Patel, N. (2013). Design and Simulation of Two Stage OTA Using 0.18 $\mu$ m and 0.35 $\mu$ m Technology. *International Journal of Engineering and Advanced Technology*, 2(3), 445-448.
- Moulahcene, F., Bouguechal, N., Benacer, I., & Hanfoug, S. (2014). Design of CMOS Two-stage Operational Amplifier for ECG Monitoring System Using 90nm Technology. *International Journal of Bio-Science and Bio-Technology*, 6(5), 55-66.
- Parihar, R., Gupta, A. (no date). Design of a Fully Differential Two-Stage CMOS Op-Amp for High Gain, High Bandwidth Applications.
- Saurabh, K. & Raja, P. (2013). Comparative Study on Cmos Based Operational Amplifier. *International Journal of Technical Research*, 2(2), 37-40.
- Sessou, K.K. (2014). Design of a class-F power amplifier with reconfigurable output harmonic termination in 0.13  $\mu$ m CMOS. Ames, Iowa: Iowa State University.





